



Micro Box

Hardware Manual

Q22, Q22-K1

2016/10/26

Table of Contents

Precautions 4

Safety Instructions.....	6
--------------------------	---

Introduction 7

List of Models.....	7
Package Contents.....	8
Physical Description.....	9
Mounting Options of Q22.....	11

Installation Procedures of Q22 12

Step 1: Mount the Bracket.....	12
Step 2: Attach the Camera.....	13
Step 3: Install the Main Unit.....	14
Step 4: Connect the Cables.....	15
Step 5: Connect to Network.....	16
Step 6: Access the Camera Live View.....	16

Installation Procedures of Q22-K1 17

Step 1: Prepare the Desktop Mount.....	17
Step 2: Attach the Camera.....	17
Step 3: Install the Main Unit.....	19
Step 4: Connect the Cables.....	20
Step 5: Connect to Network.....	21
Step 6: Access the Camera Live View.....	21

Cable Connections 22

Connecting a Power Adapter (Optional).....	22
Connecting DI/DO Devices (Optional).....	24
Connecting an Audio Out Device (Optional).....	27

Connecting a Serial Devices (Optional).....28

Other Adjustments and Accessories 29

How to Install / Remove the Memory Card29
 How to Insert the Memory Card 29
 How to Remove the Memory Card..... 30

Accessing the Camera 31

Configure the IP Addresses31
 Using DHCP Server to Assign IP Addresses..... 31
 Using the Default Camera IP Address..... 33
Access the Camera.....35

Precautions

Read these instructions

Read all the safety and operating instructions before using this product.

Heed all warnings

Adhere to all the warnings on the product and in the instruction manual. Failure to follow the safety instructions given may directly endanger people, cause damage to the system or to other equipment.

Servicing

Do not attempt to service this product yourself as opening or removing covers may expose you to dangerous voltage or other hazards. Refer all servicing to qualified service personnel.

Trademarks

ACTi and ACTi logo are registered trademarks of ACTi Corporation. All other names and products used in this manual are registered trademarks of their respective companies.

Liability

Every reasonable care has been taken during the writing of this manual. Please inform your local office if you find any inaccuracies or omissions. ACTi will not be held responsible for any typographical or technical errors and reserves the right to make changes to the product and manuals without prior notice.

Federal Communications Commission Statement



This equipment has been tested and found to comply with the limits for a class B digital device, pursuant to Part 15 of the FCC Rules. These limits are designed to provide reasonable protection against harmful interference in a residential installation. This equipment generates, uses, and can radiate radio frequency energy and, if not installed and used in accordance with the instructions, may cause harmful interference to radio communications. However, there is no guarantee that interference will not occur in a particular installation. If this equipment does cause harmful interference to radio or television reception, which can be determined by turning the equipment off and on, the user is encouraged to try to correct the interference by one or more of the following measures:

- Reorient or relocate the receiving antenna.
- Increase the separation between the equipment and receiver.
- Connect the equipment into an outlet on a circuit different from that to which the receiver is connected.
- Consult the dealer or an experienced radio/TV technician for help.

Warning: Changes or modifications to the equipment that are not expressly approved by the responsible party for compliance could void the user's authority to operate the equipment.

European Community Compliance Statement



This product has been tested and found to comply with the limits for Class B Information Technology Equipment according to European Standard EN 55024 and EN 55032. In a domestic environment, this product may cause radio interference in which cause the user may be required to take adequate measures.

Safety Instructions

Cleaning

Disconnect this product from the power supply before cleaning.

Accessories and Repair Parts

Use only the accessories and repair parts recommended by the manufacturer. Using other attachments not recommended by the manufacturer may cause hazards.

Installation

Install the main unit and other devices (such as PoE injector, alarm, etc.) that will be used with the camera in a dry place protected from weather,

Servicing

Do not attempt to service this product yourself. Refer all servicing to qualified service personnel.

Damage Requiring service

Disconnect this product from the power supply immediately and refer servicing to qualified service personnel under the following conditions.

- 1) When the power-supply cord or plug is damaged
- 2) If liquid has been spilled, or objects have fallen into the product.
- 3) If the inner parts of product have been directly exposed to rain or water.
- 4) If the product does not operate normally even by following the operating instructions in this manual. Adjust only those controls that are covered by the instruction manual, as improper adjustment of other controls may result in damage, and will often require extensive work by a qualified technician to restore the product to its normal operation.



Safety Check

Upon completion of any service or repairs to this product, ask the service technician to perform safety checks to determine if the product is in proper operating condition.

Introduction

List of Models

This hardware manual contains the following models:

Q22		2MP Outdoor Micro Box with Basic WDR, SLLS, Fixed lens
Q22-K1		2MP Outdoor Micro Box with Basic WDR, SLLS, Fixed lens

From the installation perspective, the above models are very similar; therefore one manual is used for all of them.

Package Contents

Check if the camera package comes with the following items:

Camera	Main Unit	Mounting Rail
		
Bracket (Q22 only)	PMAX-0901 (Q22-K1 only)	PMAX-1110 (Q22-K1 only)
		
Terminal Block (for DI/DO)	Terminal Block (for RS-232)	Terminal Block (for Power)
		
Camera Set Screws	Quick Installation Guide	Warranty Card
		

IMPORTANT: When the camera is taken out from the box, the lens cover is covered by a thin film. DO NOT remove this film. It is used to protect the lens cover from scratches or fingerprint marks which may happen during installation. **Remove this film after the camera is securely installed and all connections are complete.**

Physical Description



Item		Description
1	Camera Module	This is the camera lens module.
2	Built-in Microphone	Use for audio recording.
3	LED Indicators	<ul style="list-style-type: none"> • Power LED (PWR): Lights BLUE to indicate power is connected. • Link LED (LINK): Lights GREEN to indicate network is connected. • Activity LED (ACT): Flashes AMBER to indicate network activity is in progress.
4	Memory Card Slot	Insert a memory card (not included) into the slot for local recording purposes. See How to Install / Remove the Memory Card on page 29 for more information. NOTE: Supports only microSDHC and microSDXC cards.
5	Digital Input / Output	Connects to digital input or output devices, such as an alarm trigger, panic button, etc. Digital Input (DI) and Digital Output (DO) devices are used in applications like motion detection, event triggering, alarm notifications, etc. See Connecting DI/DO Devices (Optional) on page 24 for information.
6	Camera Port	Connects the camera to the main unit.

Item		Description
7	Audio Input / Output	Connects the built-in microphone and an audio output device, such as speakers. See Connecting an Audio Out Device (Optional) on page 27 for more information.
8	Ethernet Port	Connects to a network using an Ethernet cable.
9	Serial Port	Connects to serial device using the RS-232 protocol. See Connecting a Serial Devices (Optional) on page 28 for more information.
10	DC 12V Power Input	In case the camera is connected to a non-PoE (Power over Ethernet) switch, use this connector to connect the camera to an external power adapter. See Connecting a Power Adapter (Optional) on page 22 for more information.
11	Reset Button	Restores the factory default settings of the camera. To reset the camera, while the power is on, press and hold the Reset Button for at least 5 seconds or until the Power LED goes off.

Mounting Options of Q22

Below are several mounting options that you can use to install the camera. Select the most suitable solution for your installation environment.

Mount Types	Accessories
Desktop Mount	The camera is placed on counter tops, desktops, etc. using the Desktop Magnetic Base and Gooseneck. Ideal for close-up video and audio recording.
Edge Clamp	The camera can be mounted on any flat edges like desks, partitions, shelves, etc. using the Edge Clamp. The optional Gooseneck can also be attached to provide flexibility and extend the camera farther from the edge.
Pole Mount	The camera can be mounted on a horizontal pole to provide close-up video and audio recording ideal for customer service applications.

NOTE:

- For more information about the mounting solutions and accessories, please check the *Mounting Accessory Selector* in our website (<http://www.acti.com/mountingselector>).
- The above mounting accessories are not included in the package. Contact your sales agents to purchase.

Installation Procedures of Q22

Before installation, determine the location to mount the camera and the main unit. The main unit can be installed apart from where the camera is mounted, but should be close enough. Consider that the camera cable is 3 meters long. Although the camera module is waterproof, the main unit is not so it should be installed indoors.

This section describes procedures in mounting the camera on the ceiling. Similar procedures apply when mounting on walls.

NOTE:

- There is a plastic film protecting the lens. Do not remove the plastic film until the installation is complete. However, the plastic film has been removed on the camera images in this documentation to capture them more clearly.
- The camera images on this documentation are for reference only and may be different from the actual camera.

Step 1: Mount the Bracket

NOTE: Before installing the bracket, make sure the ceiling or wall can bear more than the weight of the camera and its accessories.

Install the bracket to the ceiling or wall using the three (3) screws included in the bracket package.



Step 2: Attach the Camera

The camera has two (2) installation screw holes, located on the rear or the bottom side of the camera module, where the bundled bracket can be mounted onto. Use the rear screw hole for ceiling installation while the bottom screw hole for wall installation.

NOTE: The following procedures show how to mount the bracket on the ceiling using the rear screw hole. Similar procedures apply when attaching the bracket to the bottom side for wall installation.

1. Attach the camera to the bracket through the screw hole on the rear of the camera module.



2. Loosen the knob and adjust the camera angle.



3. Route the camera cable towards the main unit.
4. Remove the thin film covering the lens.

Step 3: Install the Main Unit

NOTE: Although the camera module and lens are already waterproof, the main unit is not and should be installed indoors. Use a third party junction box with cable gland to protect the main unit and cable connections against outdoor conditions.

1. Install the mounting rail on the surface using the two (2) screws.



2. Attach the lower end of the main unit to the mounting rail.
3. Slightly push up the main unit and snap the upper end into place.

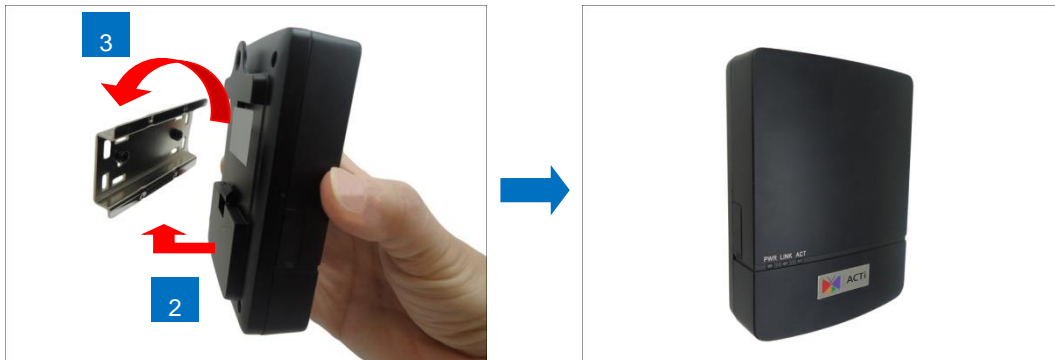

Step 4: Connect the Cables

1. Connect the camera cable connector to the **Camera** port of the main unit.
2. Connect the Audio terminal block to the Audio port of the main unit.

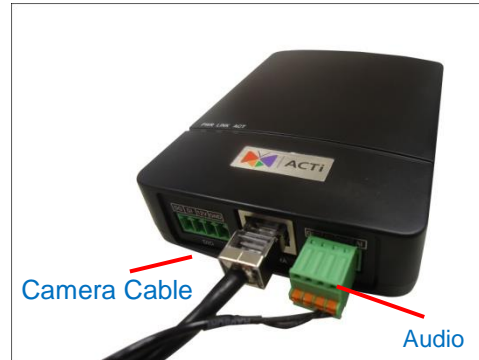

3. For excess cable, properly roll the cable as shown below; do not bend the cable.

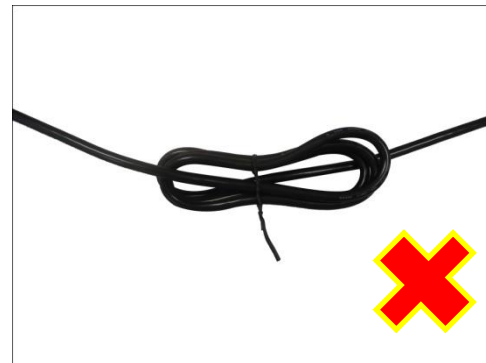
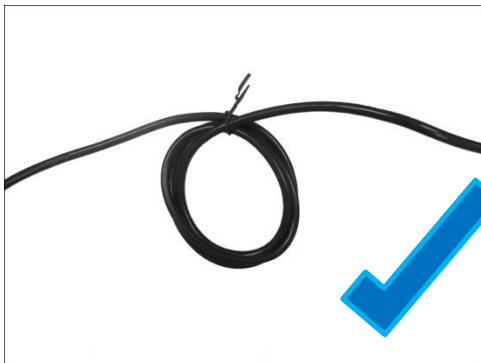

Step 5: Connect to Network

1. Connect one end of a network cable to the Ethernet port of the main unit.



2. Connect the other end to a switch or injector. Then, connect the switch or injector to a network or PC and a power source. See Power-over-Ethernet (PoE) example connection diagram below.

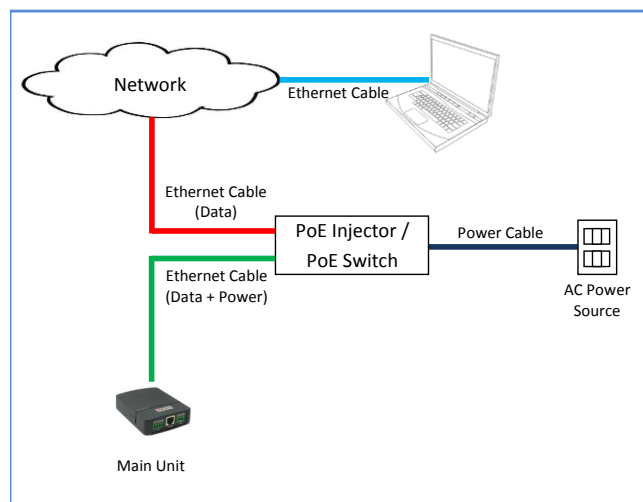

In case of using a non-PoE switch, power up the camera using a power adapter (not supplied). See [Connecting a Power Adapter \(Optional\)](#) on page 22 for more information.

3. As needed, connect and power up other devices, such as digital input/output, audio, or serial device. See [Connecting DI/DO Devices \(Optional\)](#) on page 24 for more information on connecting other devices.

Step 6: Access the Camera Live View

See [Accessing the Camera](#) on page 31 for more information on how to access the Live View of the camera.

Installation Procedures of Q22-K1

Before installation, determine the location to mount the camera and the main unit. The main unit can be installed apart from where the camera is mounted, but should be close enough, like under the desk. Consider that the camera cable is 3 meters long. Although the camera module is waterproof, the main unit is not so it should be installed indoors.

This section describes procedures in mounting the camera on the desktop.

NOTE:

- There is a plastic film protecting the lens. Do not remove the plastic film until the installation is complete. However, the plastic film has been removed on the camera images in this documentation to capture them more clearly.
- The camera images on this documentation are for reference only and may be different from the actual camera.

Step 1: Prepare the Desktop Mount

Attach the gooseneck to the magnetic base.

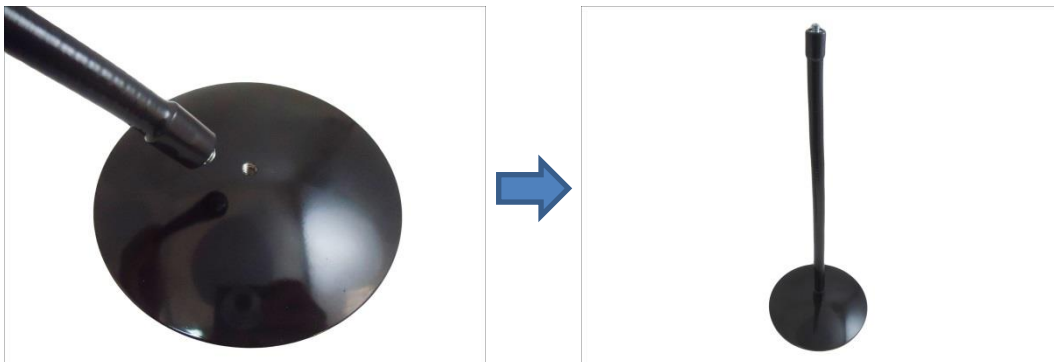

Step 2: Attach the Camera

The camera has two (2) installation screw holes, located on the rear or the bottom side of the camera module, where the gooseneck can be mounted onto.

NOTE: The following procedures show how to mount the bracket on the desktop mount using the bottom screw hole. Similar procedures apply when attaching the bracket to the rear side hole.

1. Attach the camera to the gooseneck through the screw hole on the bottom of the camera module.

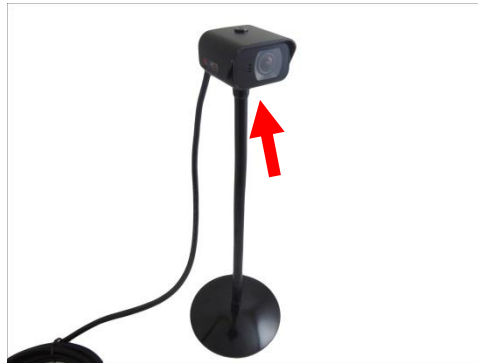

2. Route the camera cable along the gooseneck and attach it in place with the bundled Velcro strap(s).

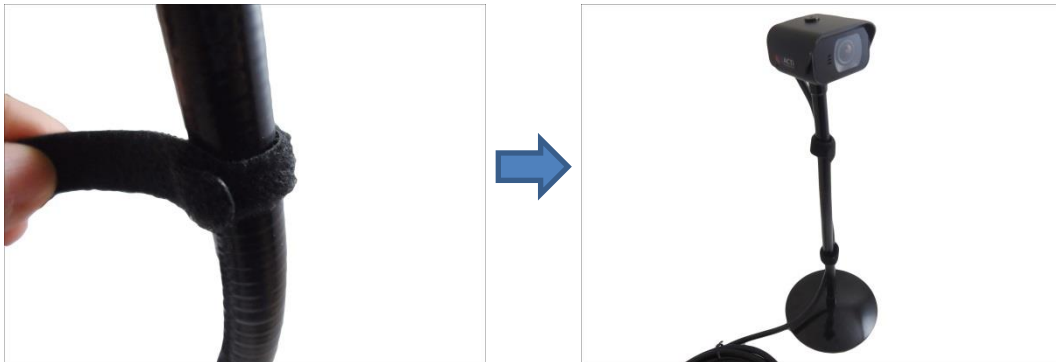

3. Bend the gooseneck to tilt or adjust the viewing position of the camera.



4. Route the camera cable towards the main unit.
5. Remove the thin film covering the lens.

Step 3: Install the Main Unit

Although the camera module is waterproof, the main unit is not and should be installed indoors.

1. Install the mounting rail on the surface using the two (2) screws.

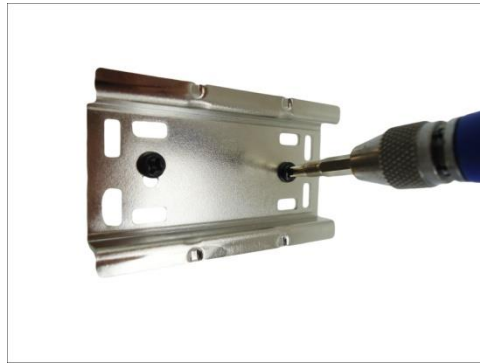

2. Attach the lower end of the main unit to the mounting rail.
3. Slightly push up the main unit and snap the upper end into place.

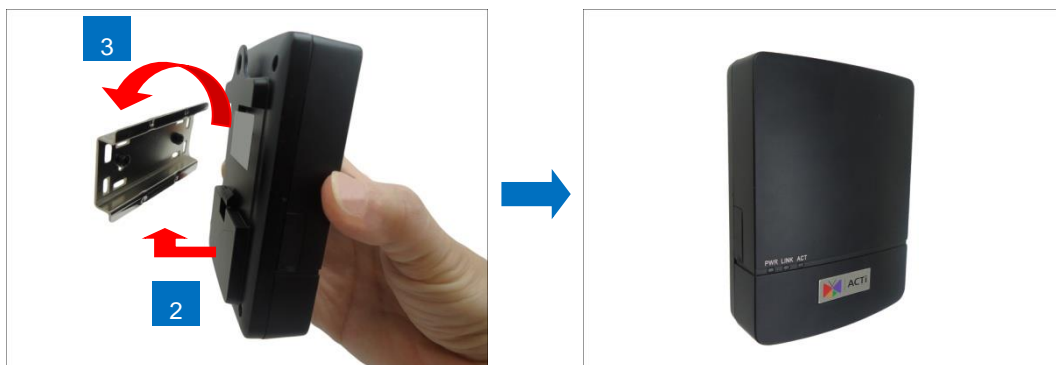

Step 4: Connect the Cables

1. Connect the camera cable connector to the **Camera** port of the main unit.
2. Connect the Audio terminal block to the Audio port of the main unit.



3. For excess cable, properly roll the cable as shown below; do not bend the cable.

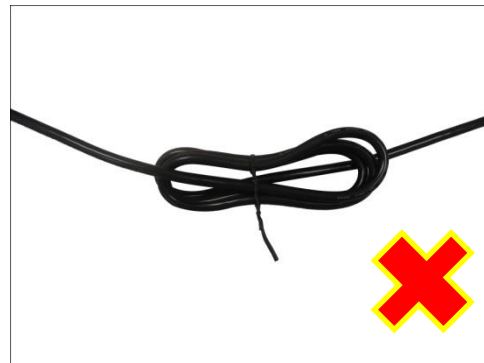
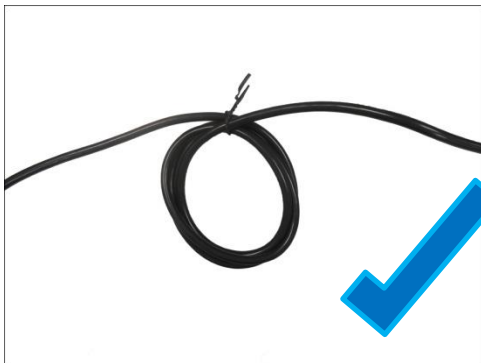

Step 5: Connect to Network

1. Connect one end of a network cable to the Ethernet port of the main unit.



2. Connect the other end to a switch or injector. Then, connect the switch or injector to a network or PC and a power source. See Power-over-Ethernet (PoE) example connection diagram below.

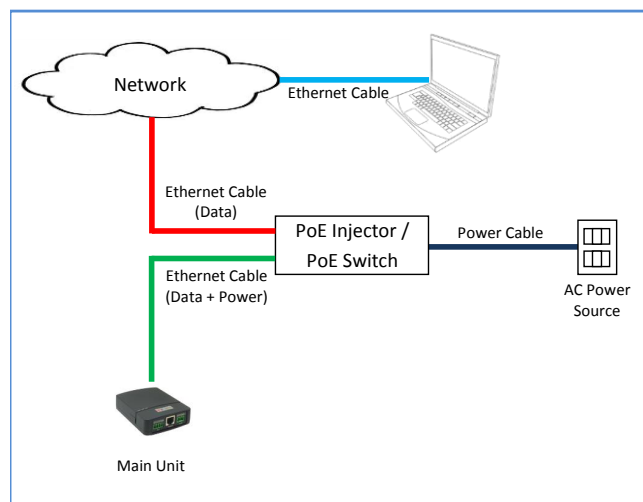

In case of using a non-PoE switch, power up the camera using a power adapter (not supplied). See [Connecting a Power Adapter \(Optional\)](#) on page 22 for more information.

3. As needed, connect and power up other devices, such as digital input/output, audio, or serial device. See [Connecting DI/DO Devices \(Optional\)](#) on page 24 for more information on connecting other devices.

Step 6: Access the Camera Live View

See [Accessing the Camera](#) on page 31 for more information on how to access the Live View of the camera.

Cable Connections

This section describes the procedures in preparing the external devices that you can connect to the camera. The camera main unit supports DC12V power input, Digital Input and Output (DI/DO), Audio Output, and Serial devices using the bundled terminal blocks. The use of these devices, however, is optional.

Connecting a Power Adapter (Optional)

The camera can be powered by a Power over Ethernet (PoE) switch that is IEEE802.3af compliant. In case of using a non-PoE switch or your PoE switch has limited power supply, you can purchase a power adapter and directly connect the camera to a power outlet. The power adapter must be connected to the supplied terminal block before use.

To do this, follow the procedures below:

1. Loosen the screws of the **12V** and **GND** pins of the power terminal block.

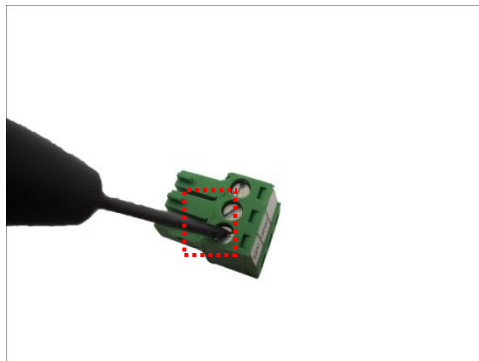

2. Take note that a standard power adapter cable has two (2) different wires:

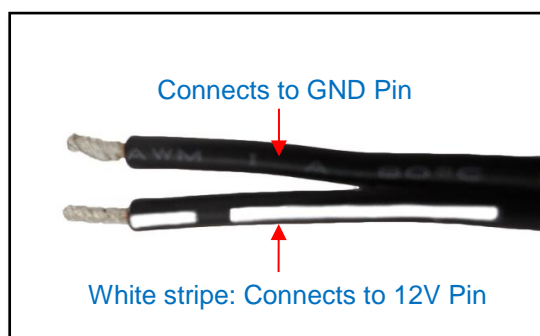

3. Connect the wire with the white stripe to the **12V** pin and the other to the **GND** pin.

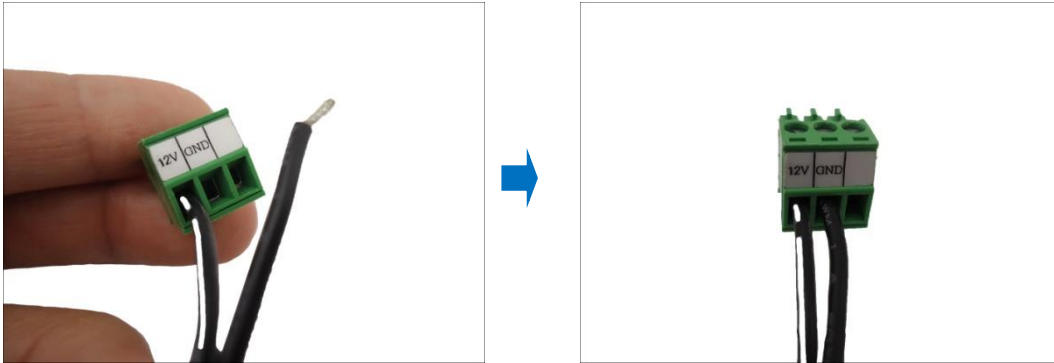

4. Tighten the screws of the **12V** pin and the **GND** pins to secure the wire connection.



5. Set the prepared power adapter for connection later. Below is an example of a power adapter with an attached terminal block.



NOTE: The power adapter is not bundled in the package.

Connecting DI/DO Devices (Optional)

Depending on your surveillance needs, you may connect one (1) digital input and one (1) digital output device to the main unit to trigger events or notifications.

Digital Input (DI) devices can be used to notify the camera about an activity in the camera site. DI can be triggers of events. For example, you can connect a “panic button” to the camera; as such when the panic button is pressed, the alarm signal will be sent through the camera. Other common DI device applications are emergency button, smoke detector, passive infrared sensor, etc.

Digital Output (DO) devices are external devices that are activated by the camera upon an event inside the camera. For example, you can connect an “alarm horn” to the camera; as such when an event occurs inside the camera (e.g. detected intruder), the alarm horn will sound. Other common DO device applications are motion-triggered lights, electric fence, magnetic door locks, etc.

1. Loosen the screws on the terminal block.
2. Connect the input/output pins to the corresponding pins on the terminal block, see mapping table below.
3. Tighten the screws on the terminal block when done.



To connect an input device (DI), map the pins as below:

Device	Pin	Mapping Instructions
Digital Input (DI)	GND	Connect the wires of the digital input device to GND and DI .
	DI	

To connect an output device (DO), map the pins as below:

Device	Pin	Mapping Instructions
Digital Output (DO)	12V	Connect the wires of the digital output device to 12V and DO .
	DO	

The table below shows the DI/DO connection specifications:

Device			
DI	Connection design		TTL - compatible logic levels
	Voltage	To trigger (low)	Logic level 0: 0V ~ 0.4V
		Normal (high)	Logic level 1: 3.1V ~ 30V
	Current		10mA ~ 100mA
DO	Connection design		Transistor (Open Collector)
	Voltage & Current		< 24V DC, < 50mA

Typical Connection

Based on these specifications, if the DI device has a voltage of 0V ~ 30V or the DO device has a voltage of < 24V (<50mA), then the camera can supply internal power to these devices and there is no need to connect the DI/DO device to an external power source.

In this case, wire connection to **GND** and **DI** pins to connect a DI device and use the **12V** and **DO** pins to connect a DO device. See wiring scheme below:

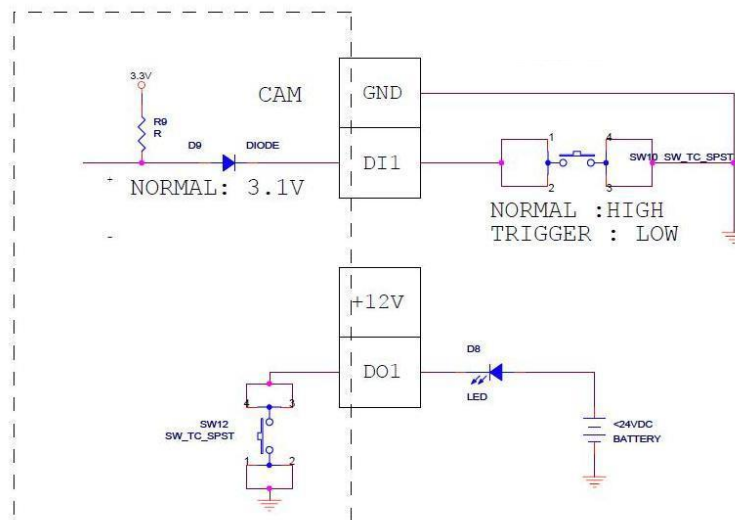

High Voltage DO Device Connection

Even though the camera provides 12V power, this may not be enough for some high voltage DO devices, such as a ceiling light or a motor that opens or closes a gate. In this case, there is a need to connect an external relay. See wiring scheme below:

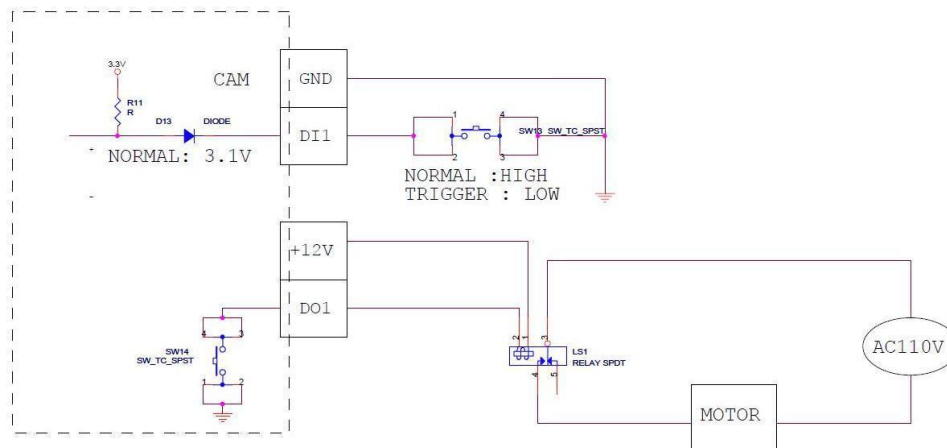

Note that when choosing an appropriate relay, please refer to its specifications and make sure they match the above design. The triggering circuit voltage has to be around 12V DC and the switch-controlled circuit voltage has to match the external power supply (e.g. 110V AC or 220V AC).

The illustration below is a graphic example of connecting a relay to a high voltage DO device.

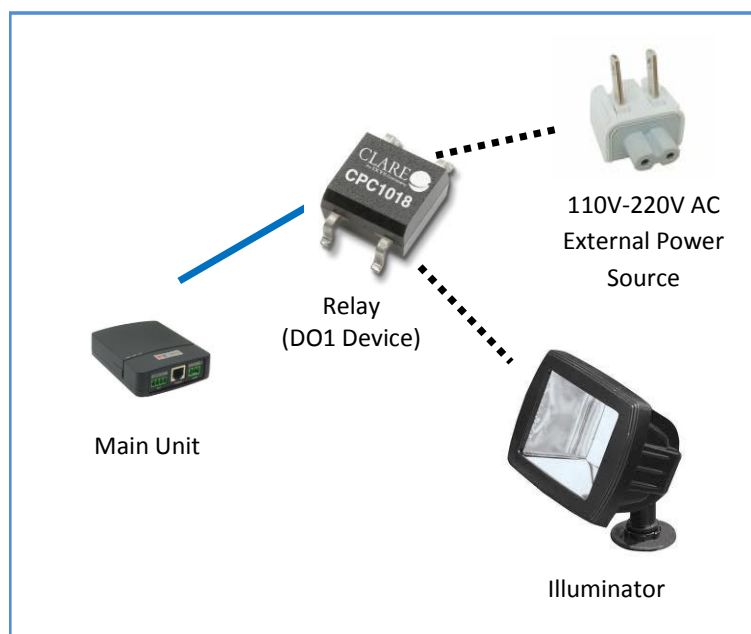

NOTE: For more information on DI/DO connections, please refer to the Knowledge Base article [All About Digital Input and Digital Output](http://Download.acti.com?id=516) downloadable from the link below (<http://Download.acti.com?id=516>).

Connecting an Audio Out Device (Optional)

Depending on your surveillance needs, you may connect an audio output device, such as a speaker, to the main unit. In this case, you need to connect the audio output device to the audio terminal block connector.

NOTE: The audio input pins are already connected to the built-in microphone. Do not modify this connection.



To connect an audio output device, map the pins to one of the pin combinations below:

Device	Pin	Mapping Instructions
Audio Output	GND	Connect the wires of the audio output device to GND and AUDIO.OUT .
	AUDIO.OUT	

Press and hold the orange tab as you insert the wire through the pin slot, then release the orange tab to secure the wire.

Connecting a Serial Devices (Optional)

Depending on your needs, you may connect a serial device to the main unit. In this case, you need to connect the serial device to the supplied RS-232 terminal block.



To connect a serial device, map the pins as below:

Terminal Block Pin Number / Label	Wire Mapping	
	Main Unit	Serial Device
TX	TX	RX
RX	RX	TX
GND	Ground pin	

Press and hold the orange tab as you insert the wire through the pin slot, then release the orange tab to secure the wire.

Other Adjustments and Accessories

How to Install / Remove the Memory Card

The camera supports local video recording to a memory card (not supplied).

NOTE: Supports microSDHC and microSDXC cards.

How to Insert the Memory Card

1. Open the memory card slot cover.



2. Insert the memory card with the metal contacts facing down the main unit.



3. Push the card until it clicks into place.



Once inserted, make sure to access the camera Web Configurator and “mount” the card to prepare the card for local recording. Refer to the camera Firmware User’s Manual for more information.

How to Remove the Memory Card

In case there is a need to remove the card, make sure to access the camera Web Configurator to safely “unmount” the card first (see the camera Firmware User’s Manual for more information).

Once unmounted from the firmware, push the card to eject it from the slot.

Accessing the Camera

Configure the IP Addresses

In order to be able to communicate with the camera from your PC, both the camera and the PC have to be within the same network segment. In most cases, it means that they both should have very similar IP addresses, where only the last number of the IP address is different from each other. There are 2 different approaches to IP Address management in Local Area Networks – by DHCP Server or Manually.

Using DHCP Server to Assign IP Addresses

If you have connected the computer and the camera into the network that has a DHCP server running, then you do not need to configure the IP addresses at all – both the camera and the PC would request a unique IP address from DHCP server automatically. In such case, the camera will immediately be ready for the access from the PC. The user, however, might not know the IP address of the camera yet. It is necessary to know the IP address of the camera in order to be able to access it by using a Web browser.

The quickest way to discover the cameras in the network is to use the simplest network search, built in the Windows system – just by pressing the “Network” icon, all the cameras of the local area network will be discovered by Windows thanks to the UPnP function support of our cameras.

In the example below, we successfully found the camera that we had just connected to the network.

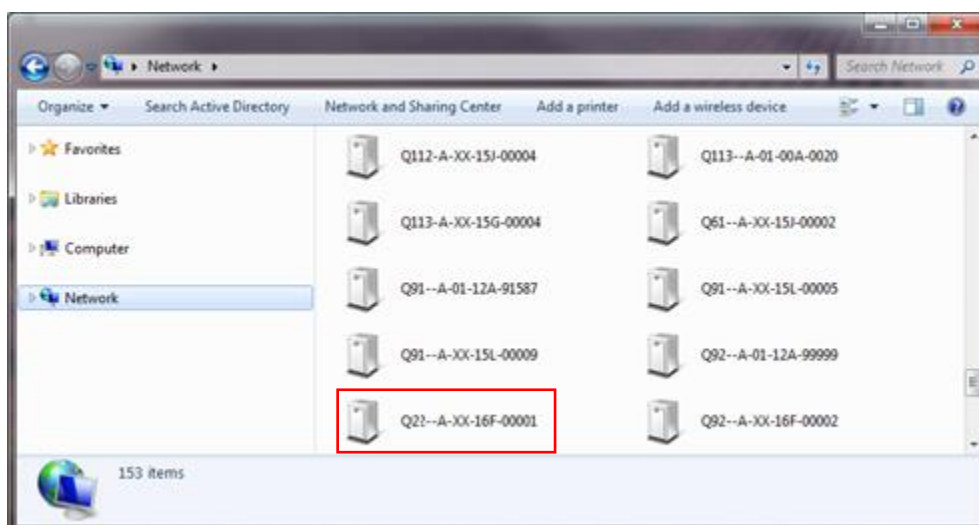

By double-clicking with the left mouse on the camera model, it is possible to automatically launch the default browser of the PC with the IP address of the target camera filled in the address bar of the browser already.

If you work with our cameras regularly, then **there is even a better way to discover the cameras in the network** – by using **IP Utility**. The IP Utility is a light software tool that can not only discover the cameras, but also list lots of valuable information, such as IP and MAC addresses, serial numbers, firmware versions, etc, and allows quick configuration of multiple devices at the same time.

The IP Utility can be downloaded for free from http://www.acti.com/IP_Utility

With just one click, you can launch the IP Utility and there will be an instant report as follows:

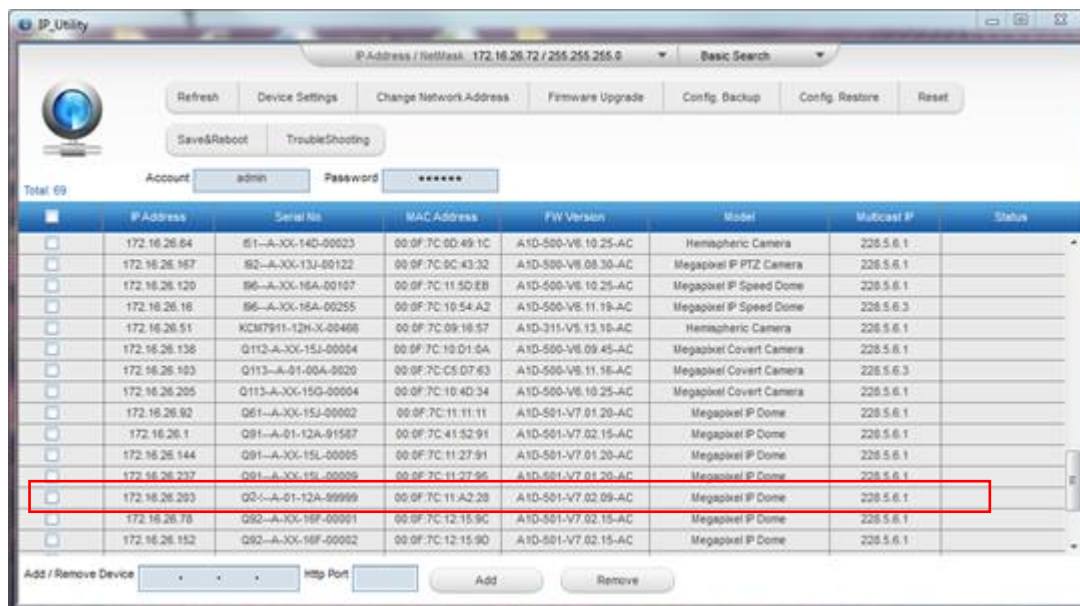

You can quickly see the camera model in the list. Click on the IP address to automatically launch the default browser of the PC with the IP address of the target camera filled in the address bar of the browser already.

Using the Default Camera IP Address

If there is no DHCP server in the given network, the user may have to assign the IP addresses to both PC and camera manually to make sure they are in the same network segment.

When the camera is plugged into network and it does not detect any DHCP services, it will automatically assign itself a default IP:

192.168.0.100

Whereas the default port number would be **80**. In order to access that camera, the IP address of the PC has to be configured to match the network segment of the camera.

Manually adjust the IP address of the PC:

In the following example, based on Windows 7, we will configure the IP address to **192.168.0.99** and set Subnet Mask to **255.255.255.0** by using the steps below:

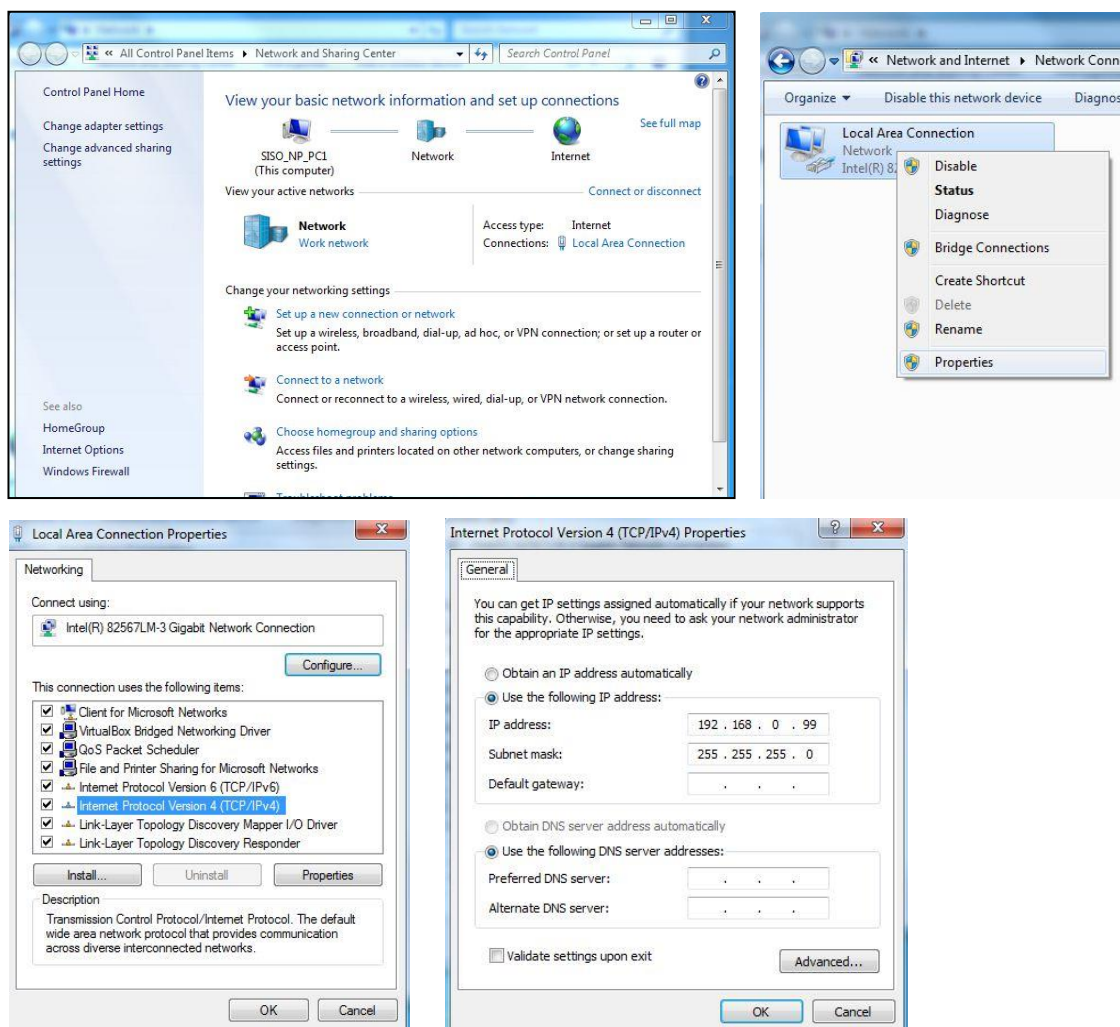

Manually adjust the IP addresses of multiple cameras:

If there are more than 1 camera to be used in the same local area network and there is no DHCP server to assign unique IP addresses to each of them, all of the cameras would then have the initial IP address of **192.168.0.100**, which is not a proper situation for network devices – all the IP addresses have to be different from each other. The easiest way to assign cameras the IP addresses is by using **IP Utility**:

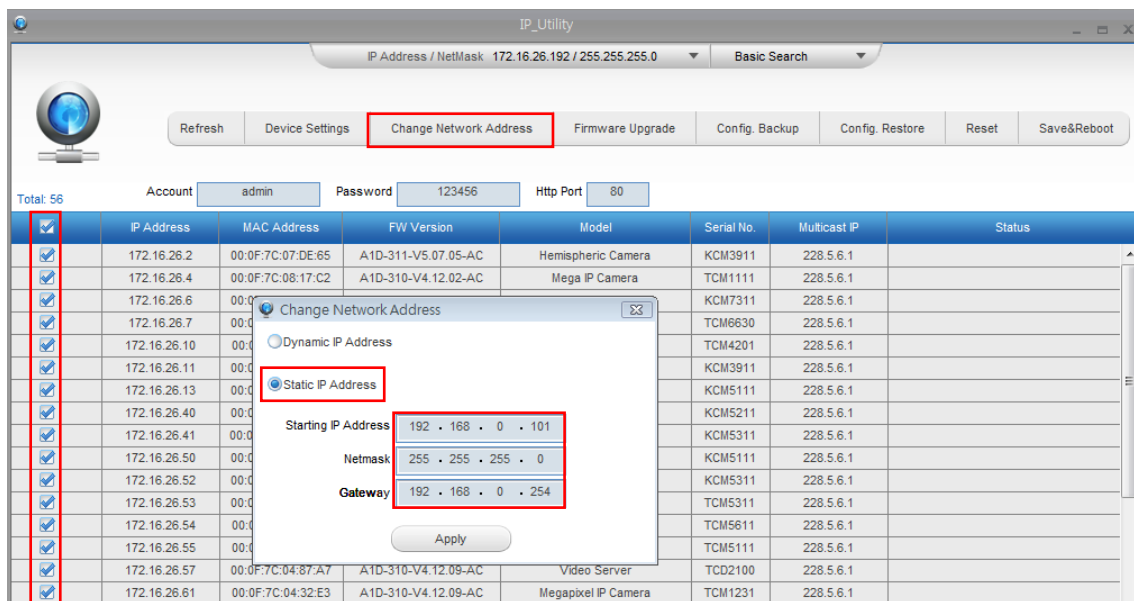

With the procedure shown above, all the cameras will have unique IP addresses, starting from 192.168.0.101. In case there are 20 cameras selected, the last one of the cameras would have the IP 192.168.0.120.

Later, by pressing the “Refresh” button of the IP Utility, you will be able to see the list of cameras with their new IP addresses.

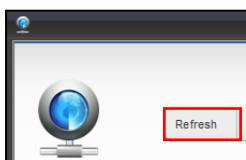

Please note that it is also possible to change the IP addresses manually by using the Web browser. In such case, please plug in only one camera at a time, and change its IP address by using the Web browser before plugging in the next one. This way, the Web browser will not be confused about two devices having the same IP address at the same time.

Access the Camera

Now that the camera and the PC are both having their unique IP addresses and are under the same network segment, it is possible to use the Web browser of the PC to access the camera.

You can use **any of the browsers** to access the camera, however, the full functionality is provided only for **Microsoft Internet Explorer**.

The browser functionality comparison:

Functionality	Internet Explorer	Other browsers
Live Video	Yes	Yes*
Live Video Area Resizable	Yes	No
PTZ Control	Yes	Yes
Capture the snapshot	Yes	Yes
Video overlay based configuration (Motion Detection regions, Privacy Mask regions)	Yes	No
All the other configurations	Yes	Yes

* When using non-Internet Explorer browsers, free third-party software plug-ins must be installed to the PC first to be able to get the live video feed from the camera:

Browser	Required Plug-In
Safari	QuickTime (http://www.apple.com/quicktime/download/)
Other non-Internet Explorer browsers	Basic VLC Media Player (http://www.videolan.org)

***Disclaimer Notice:** The camera manufacturer does not guarantee the compatibility of its cameras with VLC player or QuickTime – since these are third party softwares. The third party has the right to modify their utility any time which might affect the compatibility. In such cases, please use Internet Explorer browser instead.*

When using Internet Explorer browser, the ActiveX control for video stream management will be downloaded from the camera directly – the user just has to accept the use of such control when prompted so. No other third party utilities are required to be installed in such case.

The following examples in this manual are based on Internet Explorer browser in order to cover all functions of the camera.

Assuming that the camera's IP address is **192.168.0.100**, you can access it by opening the Web browser and typing the following address into Web browser's address bar:

http://192.168.0.100

Upon successful connection to the camera, the user interface called **Web Configurator** would appear together with the login page. The HTTP port number was not added behind the IP address since the default HTTP port of the camera is 80, which can be omitted from the address for convenience.

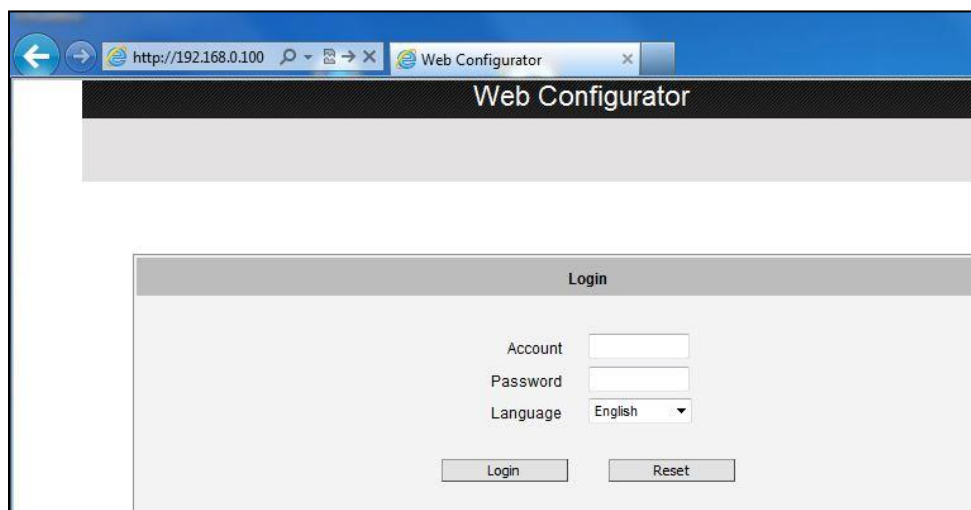

Before logging in, you need to know the factory default Account and Password of the camera.

Account: **Admin**

Password: **123456**



Copyright © 2016, ACTi Corporation All Rights Reserved

7F, No. 1, Alley 20, Lane 407, Sec. 2, Ti-Ding Blvd., Neihu District, Taipei, Taiwan 114, R.O.C.

TEL : +886-2-2656-2588 FAX : +886-2-2656-2599

Email: sales@acti.com