

# PATCHBOX Plus<sup>+</sup>

PATCHBOX Simplify IT

Network with  
Confidence

5  
YEAR

WARRANTY

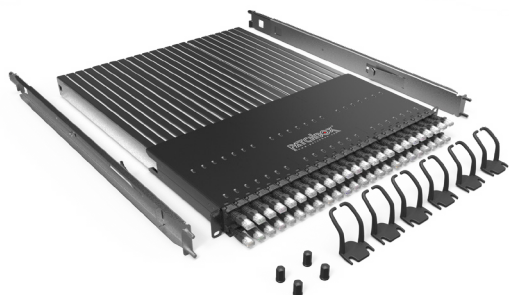

## PATCHBOX Plus+ System STP / UTP

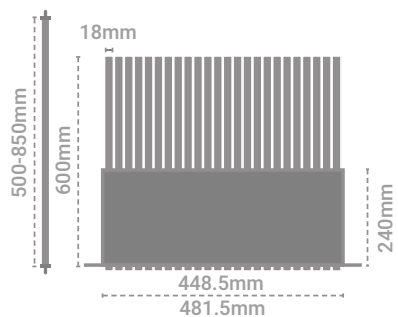

### TECHNICAL SPECIFICATIONS

#### STP CABLE

Cat.6 STP shielded, 250MHz, AWG36,  
100% stranded copper, PVC jacket, 10Gbit ready

#### UTP CABLE

Cat.6 UTP unshielded, 250MHz, AWG30,  
100% stranded copper, PVC jacket, 10Gbit ready

#### CONNECTOR

RJ45 shielded plug, pins gold plated, snagless booted

#### CABLE LENGTH

1.7m covers 26RU

#### FRAME

RAL9005 powder coated steel

#### CASSETTE PROFILES

Stainless steel, laser-welded

#### MOUNTING RAILS

Stainless steel, variable from 500mm to 850mm

#### PLASTIC PARTS

Polyoxymethylene POM

#### OPERATING TEMPERATURE RANGE

+10°C - +45°C

#### AMBIENT HUMIDITY NON-CONDENSING

10% - 95%

#### GROSS WEIGHT

11.86kg

#### PACKAGING DIMENSIONS

590mm x 760mm x 50mm WxDxH

#### HS-CODE

8544 4210

#### MADE IN THE EU

#### FOR CUSTOMERS IN AUSTRALIA & NEW ZEALAND

STP patch cords are compliant with AS/CA S008:2010  
A1:2014

### ITEMS INCLUDED

- 24 x PATCHBOX Plus+ STP / UTP Cassette with Cat.6 cable
- 1 x PATCHBOX Frame
- 6 x Patchcatch
- 2 x Adjustable mounting rails incl. HEX-Nuts
- 2 x DIN A5 tear-off ID Labels 96 Labels

### STP SHIELDED VARIANTS

PRODUCT CODE	CABLE COLOR
P60STPXC6XX24K	Black
P60STPXC6XX24B	Blue
P60STPXC6XX24G	Green
P60STPXC6XX24R	Red
P60STPXC6XX24W	White
P60STPXC6XX24Y	Yellow
P60STPXC6X24GY	Grey
P60STPXC6XX24V	Violet

### UTP UNSHIELDED VARIANTS

PRODUCT CODE	CABLE COLOR
P60UTPXC6XX24K	Black
P60UTPXC6XX24B	Blue
P60UTPXC6XX24G	Green
P60UTPXC6XX24R	Red
P60UTPXC6XX24W	White
P60UTPXC6XX24Y	Yellow
P60UTPXC6XX24V	Violet

[patchbox.com](http://patchbox.com)

All rights reserved. Specifications subject to change. E&OE. © PATCHBOX. PATCHBOX GmbH, Hernalser Gürtel 1/12, 1170 Vienna, Austria. +43 1 99 71 960, mail@patchbox.com, www.patchbox.com. © PATCHBOX 2020

# PATCHBOX Plus<sup>+</sup>

PATCHBOX Simplify IT

Network with  
Confidence

5  
YEAR

WARRANTY

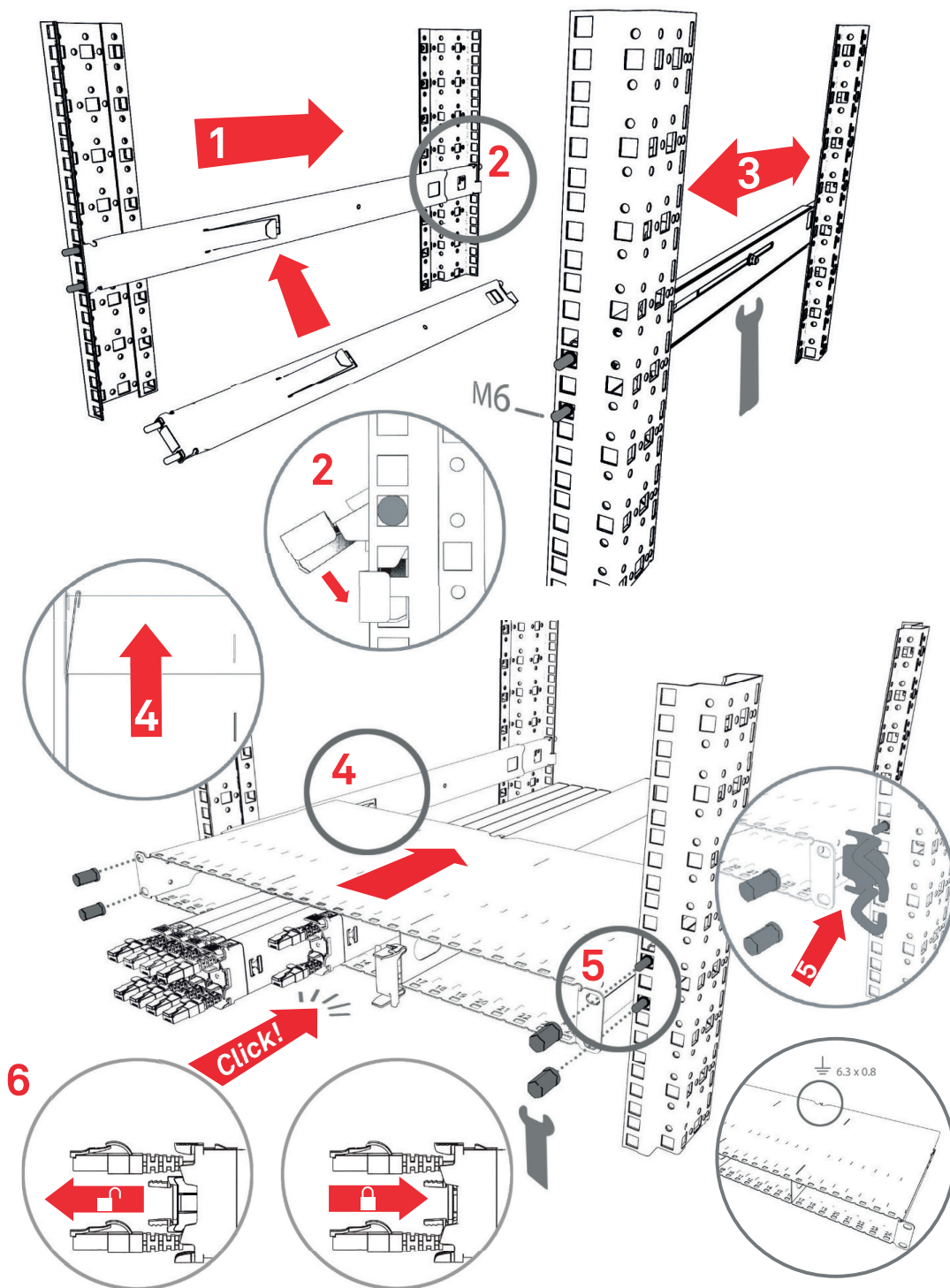

# PATCHBOX Plus<sup>+</sup>

PATCHBOX Simplify IT

Network with  
Confidence

5  
YEAR

WARRANTY

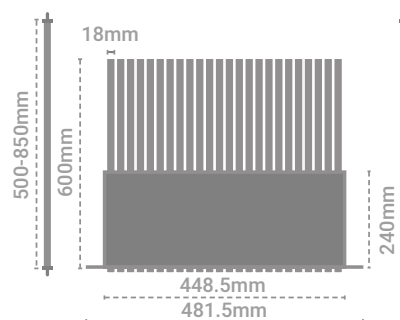

## PATCHBOX Plus+ System OS2 / OM4

### TECHNICAL SPECIFICATIONS

#### OS2 CABLE

OS2 RBS 9 $\mu$ /125 $\mu$ , G.657.A1, LSZH, Yellow OM4

#### OM4 CABLE

OM4 RBS 50 $\mu$ /125 $\mu$ , LSZH, Erika Violet

#### CONNECTOR

LC Duplex - LC Duplex / LC Duplex - SC Duplex;  
others on request.

#### CABLE LENGTH

1.7m covers 26RU

#### FRAME

RAL9005 powder coated steel

#### CASSETTE PROFILES

Stainless steel, laser-welded

#### MOUNTING RAILS

Stainless steel, variable from 500mm to 850mm

#### PLASTIC PARTS

Polyoxymethylene POM

#### OPERATING TEMPERATURE RANGE

+10°C - +45°C

#### AMBIENT HUMIDITY NON-CONDENSING:

10% - 95%

#### GROSS WEIGHT

11.86kg

#### PACKAGING DIMENSIONS

590mm x 760mm x 50mm WxDxH

#### HS-CODE

8544 4210

#### MADE IN THE EU

### ITEMS INCLUDED

- 24 x PATCHBOX Plus+ OS2 / OM4 Cassette with LC-LC /LC-SC connector
- 1 x PATCHBOX Frame
- 6 x Patchcatch
- 2 x Adjustable mounting rails incl. HEX-Nuts
- 2 x DIN A5 tear-off ID Labels 96 Labels

### OS2 VARIANTS

PRODUCT CODE	CONNECTOR TYPE
P60SMAOS21124Y	LC-LC
P60SMAOS21224Y	LC-SC

### OM4 VARIANTS

PRODUCT CODE	CONNECTOR TYPE
P60MMAOM41124E	LC-LC
P60MMAOM41224E	LC-SC

[patchbox.com](http://patchbox.com)

All rights reserved. Specifications subject to change. E&OE. © PATCHBOX. PATCHBOX GmbH, Hernalser Gürtel 1/12, 1170 Vienna, Austria. +43 1 99 71 960, mail@patchbox.com, www.patchbox.com. © PATCHBOX 2020

# PATCHBOX 365

PATCHBOX Simplify IT

Network with  
Confidence

5  
YEAR

WARRANTY

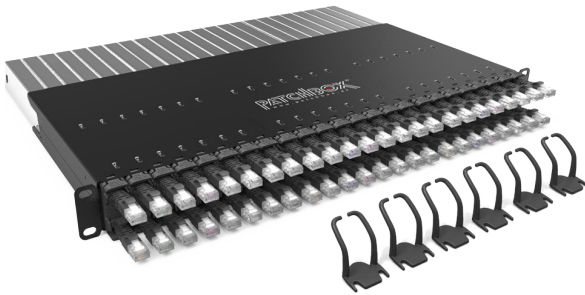

## PATCHBOX 365 System STP / UTP

### TECHNICAL SPECIFICATIONS

#### STP CABLE

Cat.6 STP shielded, 250MHz, AWG36,  
100% stranded copper, PVC jacket, 10Gbit ready

#### UTP CABLE

Cat.6 UTP unshielded, 250MHz, AWG30,  
100% stranded copper, PVC jacket, 10Gbit ready

#### CONNECTOR

RJ45 shielded plug, pins gold plated, snagless booted

#### CABLE LENGTH

0.8m covers 10RU

#### FRAME

RAL9005 powder coated steel

#### CASSETTE PROFILES

Stainless steel, laser-welded

#### PLASTIC PARTS

Polyoxymethylene POM

#### OPERATING TEMPERATURE RANGE

+10°C - +45°C

#### AMBIENT HUMIDITY NON-CONDENSING

10% - 95%

#### GROSS WEIGHT

8.6kg

#### PACKAGING DIMENSIONS

590mm x 760mm x 50mm WxDxH

#### HS-CODE

8544 4210

#### MADE IN THE EU

#### FOR CUSTOMERS IN AUSTRALIA & NEW ZEALAND

STP patch cords are compliant with AS/CA S008:2010  
A1:2014

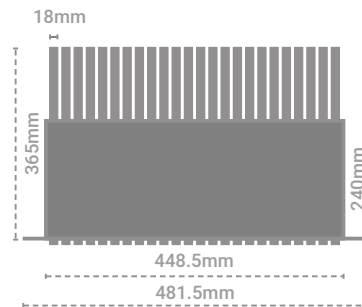

### ITEMS INCLUDED

- 24 x PATCHBOX 365 STP / UTP Cassette with Cat.6 cable
- 1 x PATCHBOX Frame
- 6 x Patchcatch
- 2 x DIN A5 tear-off ID Labels 96 Labels

### STP - SHIELDED VARIANTS

PRODUCT CODE	CABLE COLOR
P36STPXC6XX24K	Black
P36STPXC6XX24B	Blue
P36STPXC6XX24G	Green
P36STPXC6XX24R	Red
P36STPXC6XX24W	White
P36STPXC6XX24Y	Yellow
P36STPXC6X24GY	Grey
P36STPXC6XX24V	Violet

### UTP - UNSHIELDED VARIANTS

PRODUCT CODE	CABLE COLOR
P36UTPXC6XX24K	Black
P36UTPXC6XX24B	Blue
P36UTPXC6XX24G	Green
P36UTPXC6XX24R	Red
P36UTPXC6XX24W	White
P36UTPXC6XX24Y	Yellow
P36UTPXC6XX24V	Violet

# PATCHBOX 365

PATCHBOX Simplify IT

Network with  
Confidence

5  
YEAR

WARRANTY

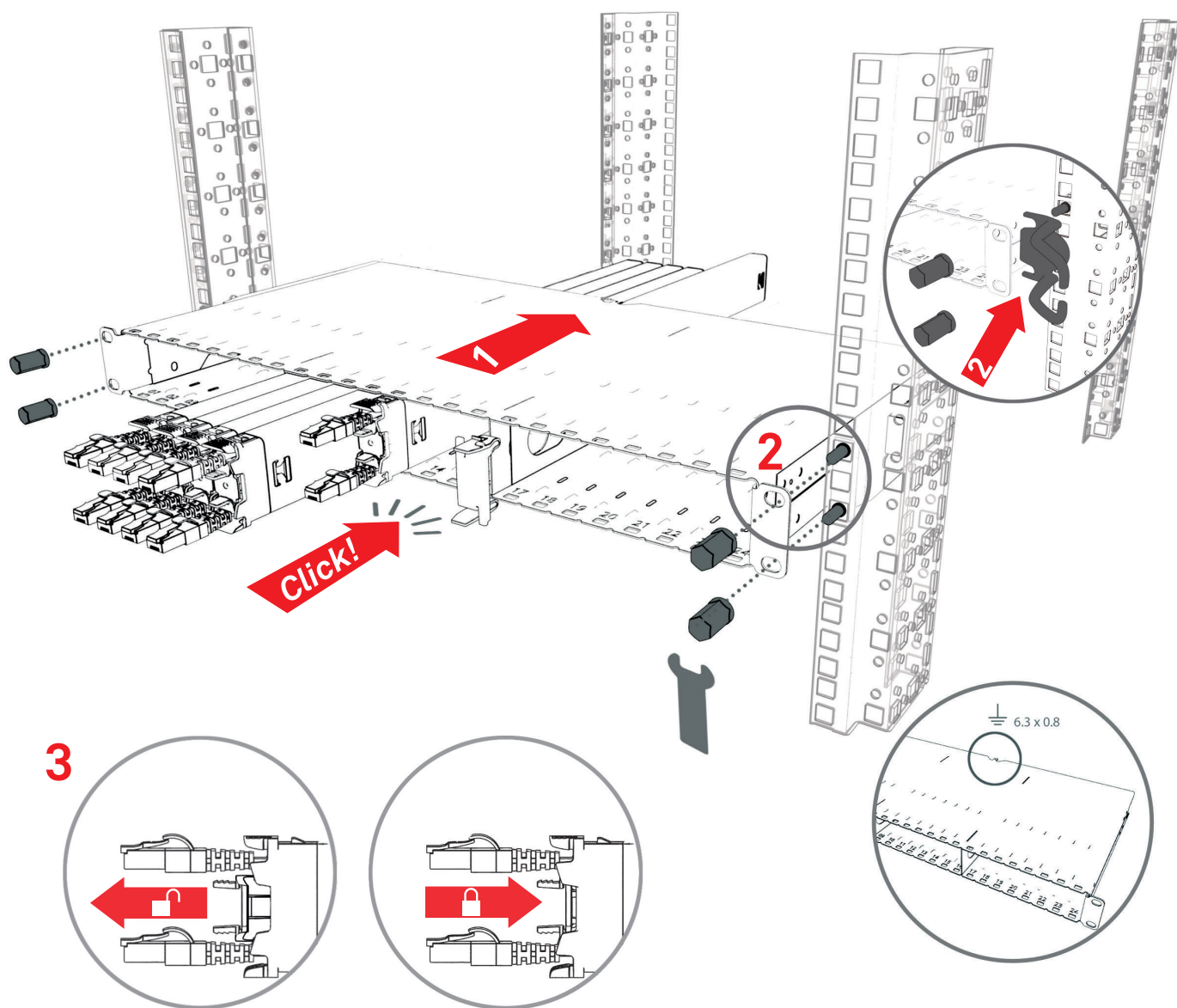

# PATCHBOX Plus<sup>+</sup>

PATCHBOX Simplify IT

Network with  
Confidence

5  
YEAR

WARRANTY

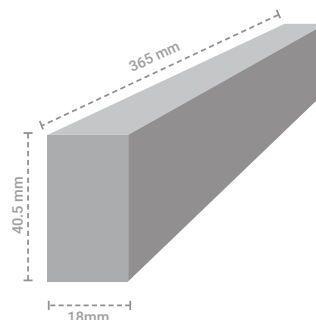
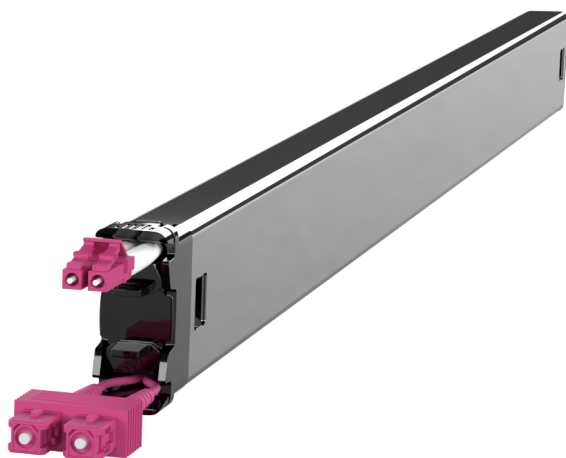

## PATCHBOX Plus+ Cassettes OS2 / OM4

### TECHNICAL SPECIFICATIONS

#### OS2 CABLE

OS2 RBS 9 $\mu$ /125 $\mu$ , G.657.A1, LSZH, Yellow

#### OM4 CABLE

OM4 RBS 50 $\mu$ /125 $\mu$ , LSZH, Erika Violet

#### CONNECTOR

LC Duplex - LC Duplex / LC Duplex - SC Duplex

#### CABLE LENGTH

1.7m covers 26RU

#### CASSETTE PROFILES

Stainless steel, laser-welded

#### PLASTIC PARTS

Polyoxymethylene POM

#### OPERATING TEMPERATURE RANGE

+10°C - +45°C

#### AMBIENT HUMIDITY NON-CONDENSING

10% - 95%

#### GROSS WEIGHT

0.4kg

#### PACKAGING DIMENSIONS

69mm x 50mm x 50mm WxDxH

#### HS-CODE

8544 4210

#### MADE IN THE EU

### ITEMS INCLUDED

1 x PATCHBOX Plus+ OS2 / OM4 Cassette with  
LC-LC / LC-SC connector

### OS2 VARIANTS

PRODUCT CODE	CONNECTOR TYPE
C60SMAOS211X1Y	LC-LC
C60SMAOS212X1Y	LC-SC

### OM4 VARIANTS

PRODUCT CODE	CONNECTOR TYPE
C60MMAOM411X1E	LC-LC
C60MMAOM412X1E	LC-SC

# PATCHBOX Plus<sup>+</sup>

PATCHBOX Simplify IT

Network with  
Confidence

5  
YEAR

WARRANTY

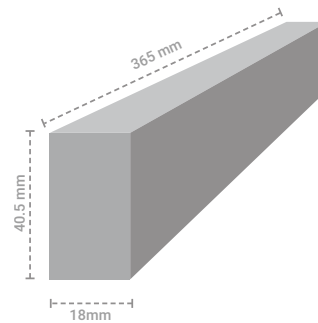

## PATCHBOX Plus+ Long Range Cassettes - OS2 / OM4

### TECHNICAL SPECIFICATIONS

#### OS2 CABLE

OS2 RBS 9µ/125µ, G.657.A1, LSZH, Yellow

#### OM4 CABLE

OM4 RBS 50µ/125µ, LSZH, Erika Violet

#### CONNECTOR

LC Duplex - LC Duplex / LC Duplex - SC Duplex

#### CABLE LENGTH

2.7m extractable / 1m over length non-retractable,  
covers 48RU from mid-mid

#### CASSETTE PROFILES

Stainless steel, laser-welded

#### PLASTIC PARTS

Polyoxymethylene POM

#### OPERATING TEMPERATURE RANGE

+10°C - +45°C

#### AMBIENT HUMIDITY NON-CONDENSING

10% - 95%

#### GROSS WEIGHT

0.42kg

#### PACKAGING DIMENSIONS

69mm x 50mm x 50mm WxDxH

#### HS-CODE

8544 4210

#### MADE IN THE EU

### ITEMS INCLUDED

1 x PATCHBOX Plus+ OS2 / OM4 Long Range  
Cassette with LC-LC / LC-SC connector

### OS2 VARIANTS

PRODUCT CODE	CONNECTOR TYPE
C60SMAOS21131Y	LC-LC
C60SMAOS21231Y	LC-SC

### OM4 VARIANTS

PRODUCT CODE	CONNECTOR TYPE
C60MMAOM41131E	LC-LC
C60MMAOM41231E	LC-SC

# PATCHBOX Plus<sup>+</sup>

PATCHBOX Simplify IT

Network with  
Confidence

5  
YEAR

WARRANTY

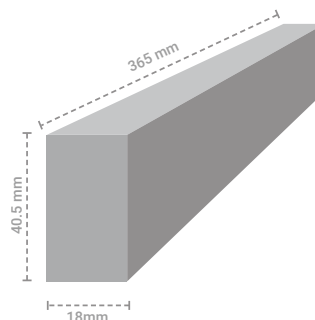

## PATCHBOX Plus+ Cassettes STP / UTP

### TECHNICAL SPECIFICATIONS

#### STP CABLE

Cat.6 STP shielded, 250MHz, AWG36,  
100% stranded copper, PVC jacket, 10Gbit ready

#### UTP CABLE

Cat.6 UTP unshielded, 250MHz, AWG30,  
100% stranded copper, PVC jacket, 10Gbit ready

#### CONNECTOR

RJ45 shielded plug, pins gold plated, snagless booted

#### CABLE LENGTH

1.7m covers 26RU

#### CASSETTE PROFILES

Stainless steel, laser-welded

#### PLASTIC PARTS

Polyoxymethylene POM

#### OPERATING TEMPERATURE RANGE

+10°C - +45°C

#### AMBIENT HUMIDITY NON-CONDENSING

10% - 95%

#### GROSS WEIGHT

0.4kg

#### PACKAGING DIMENSIONS

69mm x 50mm x 50mm WxDxH

#### HS-CODE

8544 4210

#### MADE IN THE EU

#### FOR CUSTOMERS IN AUSTRALIA & NEW ZEALAND

STP patch cords are compliant with AS/CA S008:2010  
A1:2014

### ITEMS INCLUDED

1 x PATCHBOX Plus+ STP / UTP Cassette with  
Cat.6 cable

### STP - SHIELDED VARIANTS

PRODUCT CODE	CABLE COLOR
C60STPXC6XXX1K	Black
C60STPXC6XXX1B	Blue
C60STPXC6XXX1G	Green
C60STPXC6XXX1R	Red
C60STPXC6XXX1W	White
C60STPXC6XXX1Y	Yellow
C60STPXC6XX1GY	Grey
C60STPXC6XXX1V	Violet

### UTP - UNSHIELDED VARIANTS

PRODUCT CODE	CABLE COLOR
C60UTPXC6XXX1K	Black
C60UTPXC6XXX1B	Blue
C60UTPXC6XXX1G	Green
C60UTPXC6XXX1R	Red
C60UTPXC6XXX1W	White
C60UTPXC6XXX1Y	Yellow
P60UTPXC6XX24V	Violet

[patchbox.com](http://patchbox.com)

All rights reserved. Specifications subject to change. E&OE. © PATCHBOX. PATCHBOX GmbH, Hernalser Gürtel 1/12, 1170 Vienna, Austria. +43 1 99 71 960, mail@patchbox.com, www.patchbox.com. © PATCHBOX 2020



# PATCHBOX Plus<sup>+</sup>

PATCHBOX Simplify IT

Network with  
Confidence

5  
YEAR

WARRANTY

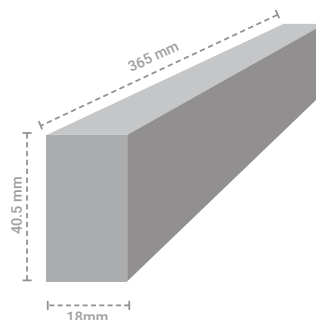
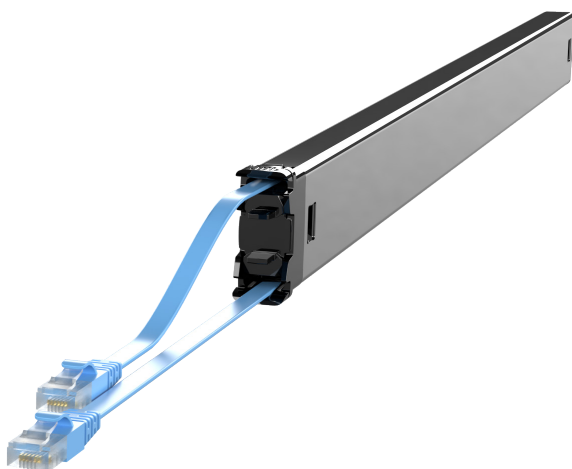

## PATCHBOX Plus+ Long Range Cassettes - STP / UTP

### TECHNICAL SPECIFICATIONS

#### STP CABLE

Cat.6 STP shielded, 250MHz, AWG36,  
100% stranded copper, PVC jacket, 10Gbit ready

#### UTP CABLE

Cat.6 UTP unshielded, 250MHz, AWG30,  
100% stranded copper, PVC jacket, 10Gbit ready

#### CONNECTOR

RJ45 shielded plug, pins gold plated, snagless booted

#### CABLE LENGTH

2.7m extractable / 1m over, length non-retractable,  
covers 48RU from mid-mid

#### CASSETTE PROFILES

Stainless steel, laser-welded

#### PLASTIC PARTS

Polyoxymethylene POM

#### OPERATING TEMPERATURE RANGE

+10°C - +45°C

#### AMBIENT HUMIDITY NON-CONDENSING

10% - 95%

#### GROSS WEIGHT

0.42kg

#### PACKAGING DIMENSIONS

69mm x 50mm x 50mm WxDxH

#### HS-CODE

8544 4210

#### MADE IN THE EU # FOR CUSTOMERS IN AUSTRALIA & NEW ZEALAND

STP patch cords are compliant with AS/CA S008:2010  
A1:2014

### ITEMS INCLUDED

- 1 x PATCHBOX Plus+ STP / UTP  
Long Range Cassette with Cat.6 cable

### STP - SHIELDED VARIANTS

PRODUCT CODE	CABLE COLOR
C60STPXC6XX31K	Black
C60STPXC6XX31B	Blue
C60STPXC6XX31G	Green
C60STPXC6XX31R	Red
C60STPXC6XX31W	White
C60STPXC6XX31Y	Yellow
C60STPXC6X31GY	Grey
C60STPXC6XX31V	Violet

### UTP - UNSHIELDED VARIANTS

PRODUCT CODE	CABLE COLOR
C60UTPXC6XX31K	Black
C60UTPXC6XX31B	Blue
C60UTPXC6XX31G	Green
C60UTPXC6XX31R	Red
C60UTPXC6XX31W	White
C60UTPXC6XX31Y	Yellow
C60UTPXC6XX31V	Violet

# PATCHBOX 365

PATCHBOX Simplify IT

Network with  
Confidence

5  
YEAR

WARRANTY

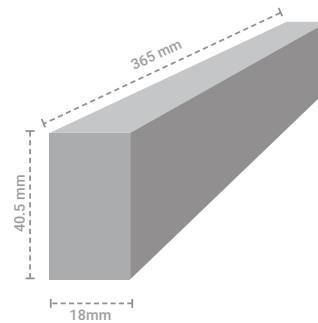
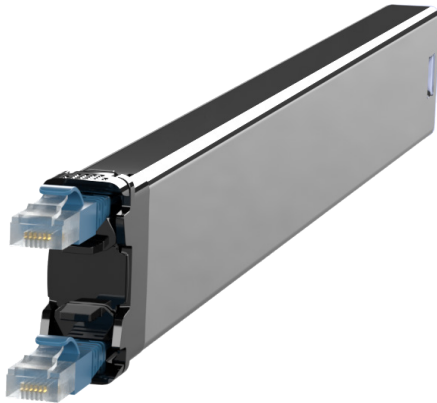

## PATCHBOX 365 Cassettes STP / UTP

### TECHNICAL SPECIFICATIONS

#### STP CABLE

Cat.6 STP shielded, 250MHz, AWG36,  
100% stranded copper, PVC jacket, 10Gbit ready

#### UTP CABLE

Cat.6 UTP unshielded, 250MHz, AWG30,  
100% stranded copper, PVC jacket, 10Gbit ready

#### CONNECTOR

RJ45 shielded plug, pins gold plated, snagless booted

#### CABLE LENGTH

0.8m covers 10RU

#### CASSETTE PROFILES

Stainless steel, laser-welded

#### PLASTIC PARTS

Polyoxymethylene POM

#### OPERATING TEMPERATURE RANGE

+10°C - +45°C

#### AMBIENT HUMIDITY NON-CONDENSING

10% - 95%

#### GROSS WEIGHT

0.32kg

#### PACKAGING DIMENSIONS

69mm x 50mm x 50mm WxDxH

#### HS-CODE

8544 4210

#### MADE IN THE EU

#### FOR CUSTOMERS IN AUSTRALIA & NEW ZEALAND

STP patch cords are compliant with AS/CA S008:2010  
A1:2014

### ITEMS INCLUDED

1 x PATCHBOX 365 STP / UTP Cassette with  
Cat.6 cable

### STP - SHIELDED VARIANTS

PRODUCT CODE	CABLE COLOR
C36STPXC6XXX1K	Black
C36STPXC6XXX1B	Blue
C36STPXC6XXX1G	Green
C36STPXC6XXX1R	Red
C36STPXC6XXX1W	White
C36STPXC6XXX1Y	Yellow
C36STPXC6XX1GY	Grey

### UTP - UNSHIELDED VARIANTS

PRODUCT CODE	CABLE COLOR
C36UTPXC6XXX1K	Black
C36UTPXC6XXX1B	Blue
C36UTPXC6XXX1G	Green
C36UTPXC6XXX1R	Red
C36UTPXC6XXX1W	White
C36UTPXC6XXX1Y	Yellow
C36UTPXC6XXX1V	Violet

[patchbox.com](http://patchbox.com)

All rights reserved. Specifications subject to change. E&OE. © PATCHBOX. PATCHBOX GmbH, Hernalser Gürtel 1/12, 1170 Vienna, Austria. +43 1 99 71 960, mail@patchbox.com, www.patchbox.com. © PATCHBOX 2020

# PATCHBOX Plus<sup>+</sup>

PATCHBOX Simplify IT

Network with  
Confidence

5  
YEAR

WARRANTY

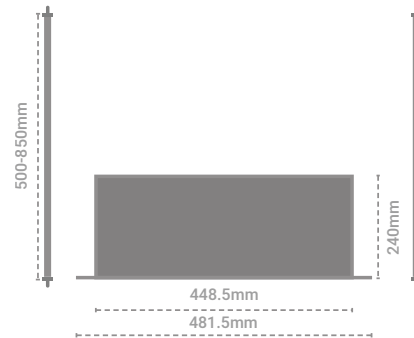
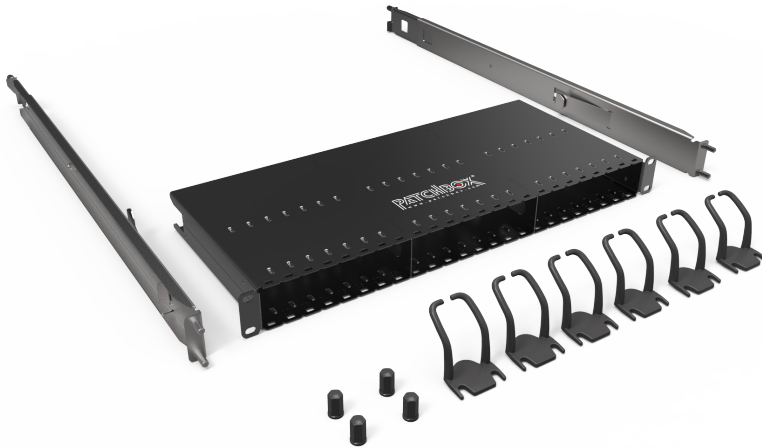

## PATCHBOX Plus+ Frame

### TECHNICAL SPECIFICATIONS

#### FRAME

RAL9005 powder coated steel

#### PLASTIC PARTS

Polyoxymethylene POM

#### OPERATING TEMPERATURE RANGE

+10°C - +45°C

#### AMBIENT HUMIDITY NON-CONDENSING

10% - 95%

#### GROSS WEIGHT

4.18kg

#### MOUNTING RAILS

Stainless Steel, 500mm to 850mm

#### DIMENSIONS

481.5 - 448.5mm x 500 - 850mm x 50mm WxDxH

#### PACKAGING DIMENSIONS

590mm x 760mm x 50mm WxDxH

#### HS-CODE

8538 9099

#### MADE IN THE EU

### ITEMS INCLUDED

- 1 x PATCHBOX Frame
- 2 x Mounting rails incl. HEX-Nuts
- 6 x Patchcatch
- 2 x DIN A5 tear-off ID Labels 96 Labels

### PRODUCT CODE

PBXFRAME

# PATCHBOX 365

PATCHBOX Simplify IT

Network with  
Confidence

5  
YEAR

WARRANTY

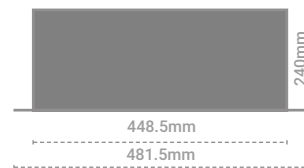

## PATCHBOX 365 Frame

### TECHNICAL SPECIFICATIONS

#### FRAME

RAL9005 powder coated steel

#### PLASTIC PARTS

Polyoxymethylene POM

#### MOUNTING RAILS

Stainless Steel, 500mm to 850mm from 19" rail to 19" rail

#### OPERATING TEMPERATURE RANGE

+10°C - +45°C

#### AMBIENT HUMIDITY NON-CONDENSING

10% - 95%

#### GROSS WEIGHT

3.15kg

#### DIMENSIONS

481.5 - 448.5mm x 240mm x 50mm WxDxH

#### PACKAGING DIMENSIONS

590mm x 760mm x 50mm WxDxH

#### HS-CODE

8538 9099

#### PRODUCT COMPLIES WITH ROHS AND CE

#### MADE IN THE EU

### ITEMS INCLUDED

- 1 x PATCHBOX Frame
- 6 x Patchcatch
- 2 x DIN A5 tear-off ID Labels 96 Labels

### STP SHIELDED VARIANTS

PBXFRAME365

# SETUP.EXE

PATCHBOX Simplify IT

Network with  
Confidence

**LIFE  
TIME**  
WARRANTY



## Setup.exe

### DESCRIPTION

---

The Setup.exe enables one technician to do the job of two. The Setup.exe secures the weight of equipment, such as switches, in server and network racks until they are securely screwed in. Mounted inside out of a rack the Setup.exe creates the ideal workspace to place a laptop during configuration or terminating a patch panel.

### TECHNICAL SPECIFICATIONS

---

#### DIMENSIONS FOLDED

55mm x 460mm x 45mm WxDxH

#### DIMENSIONS OPENED

482.6mm x 380mm x 45mm WxDxH

#### MATERIALS

Aluminium, Stainless steel, powder coated steel

#### GROSS WEIGHT

0.88kg

#### PACKAGING DIMENSIONS

51mm x 600mm x 55mm WxDxH

#### HS-CODE

8538 9099

#### MADE IN GERMANY

### ITEMS INCLUDED

---

1 x Setup.exe

### PRODUCT CODE

---

PBXEXE

# SETUP.EXE

PATCHBOX Simplify IT

Network with  
Confidence

**LIFE  
TIME**  
WARRANTY

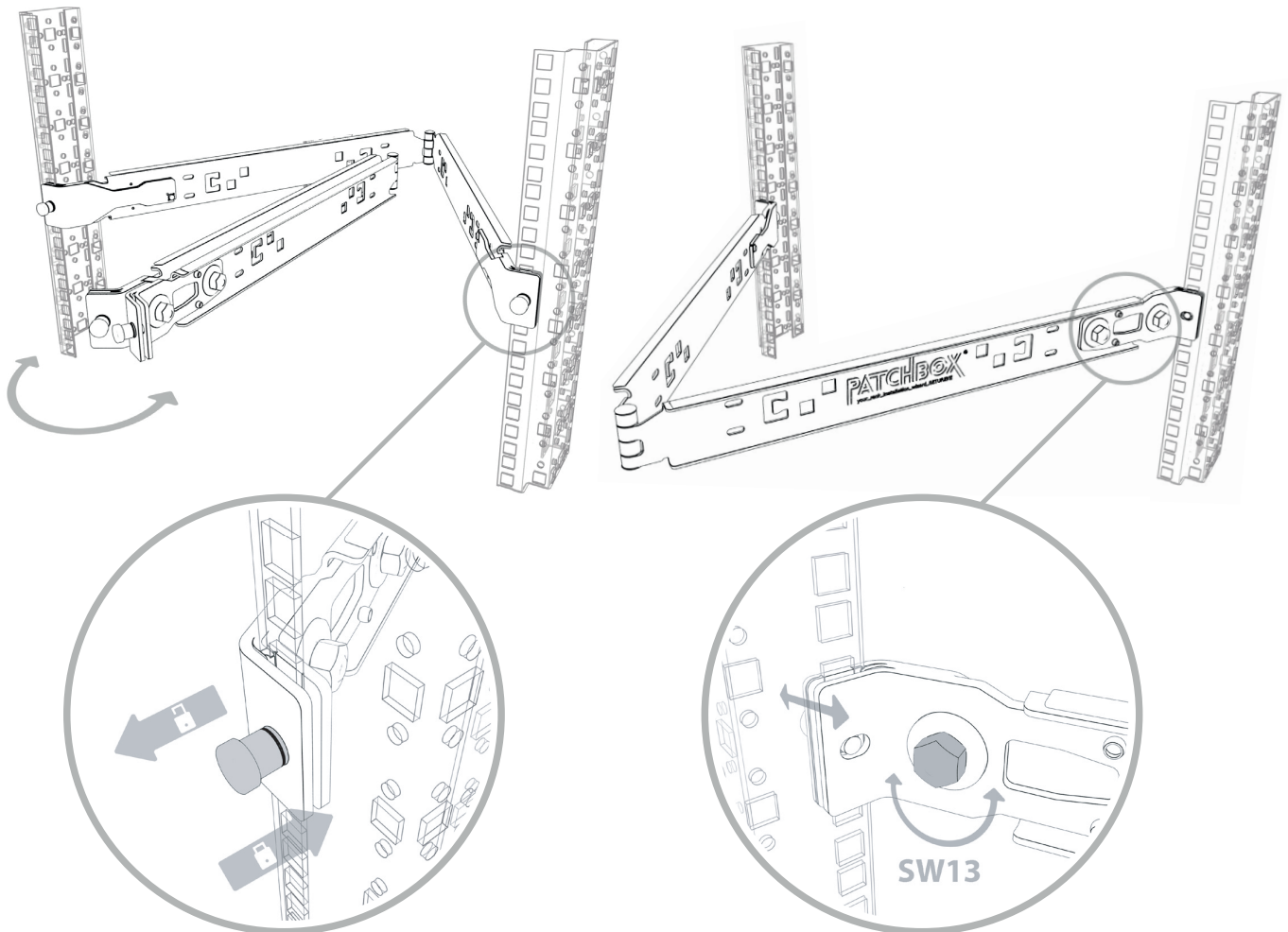

## Setup.exe - manual

Warning: Please clarify the load capacity of the server rack with the manufacturer. Always check assembly aid for tightness before loading. Assembly aid needs to be free from contamination, such as oil and lubricants. Make sure all nuts are tight. Before loading, make sure that the locking pins are fully inserted. If necessary, remove the extended locking bolts with one turn. Loads must not be pushed over the joint of the assembly aid (risk of overloading). Loads must be protected from the risk of damage caused by falling down through appropriate additional measures. The mounting aid includes magnets. Keep away from data carriers, magnetic storage devices and sensitive electronic devices. Supports <15kg. Keep away from children, risk of swallowing small parts.

# PATCHBOX Patchcatch

PATCHBOX Simplify IT

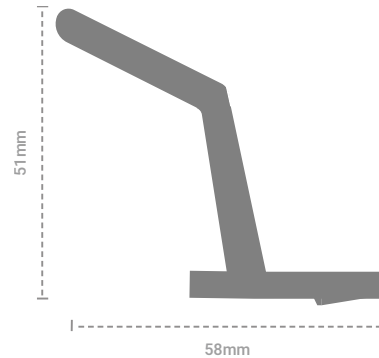

## PATCHBOX Patchcatch

### DESCRIPTION

---

Our innovative cable organizer with zero rack units - the Patchcatch 0RU - can simply be mounted under the mounting brackets of switches and patch panels. Compared to conventional horizontal cable management it does not take any additional space in a network cabinet. All patch cords - Cat6 and fibre optics - are guided to the side of the RU and are patched to keep the cabinet nice and tidy. No more cable spaghetti! The Patchcatch works with conventional patch cords as good as with the PATCHBOX. A great alternative to conventional cable management. Every PATCHBOX System as well as PATCHBOX Frame includes 6 Patchcatches.

### TECHNICAL SPECIFICATIONS

---

#### PLASTIC PARTS

Polyoxymethylene POM

#### OPERATING TEMPERATURE RANGE

+10°C - +45°C

#### AMBIENT HUMIDITY NON-CONDENSING

10% - 95%

#### WEIGHT

0.06kg

#### PACKAGING DIMENSIONS

95mm x 102mm x 40mm WxDxH

#### HS-CODE

8538 9099

#### MADE IN THE EU

### ITEMS INCLUDED

---

4 x Patchcatch

### PRODUCT CODE

---

PBCX8K

# PATCHBOX ID Labels

PATCHBOX Simplify IT

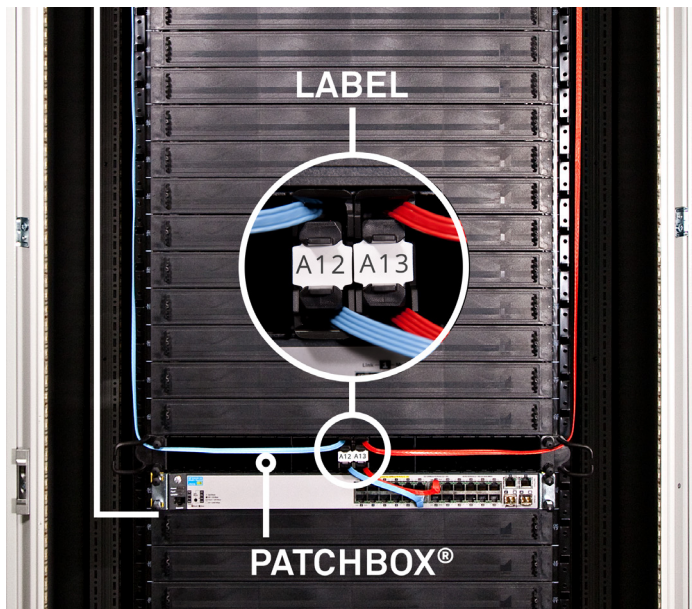

## PATCHBOX ID Labels

### DESCRIPTION

---

The ID Labels are simply slid onto the cable stopper on the Cassette. When the PATCHBOX is mounted above or underneath a switch you already have a logical assignment of the Cassettes to the switch ports. With the patch panel port written on the ID Label you see all your connections with an blink of the eye.

### TECHNICAL SPECIFICATIONS

---

**WEIGHT**

0.02kg

**PACKAGING DIMENSIONS**

160mm x 235mm x 20mm WxDxH

**HS-CODE**

8538 9099

**MADE IN THE EU**

### ITEMS INCLUDED

---

2 x DIN A5 tear-off ID Labels 96 Labels

### PRODUCT CODE

---

IDLABELW



# PATCHBOX **Blind Panel**

PATCHBOX Simplify IT

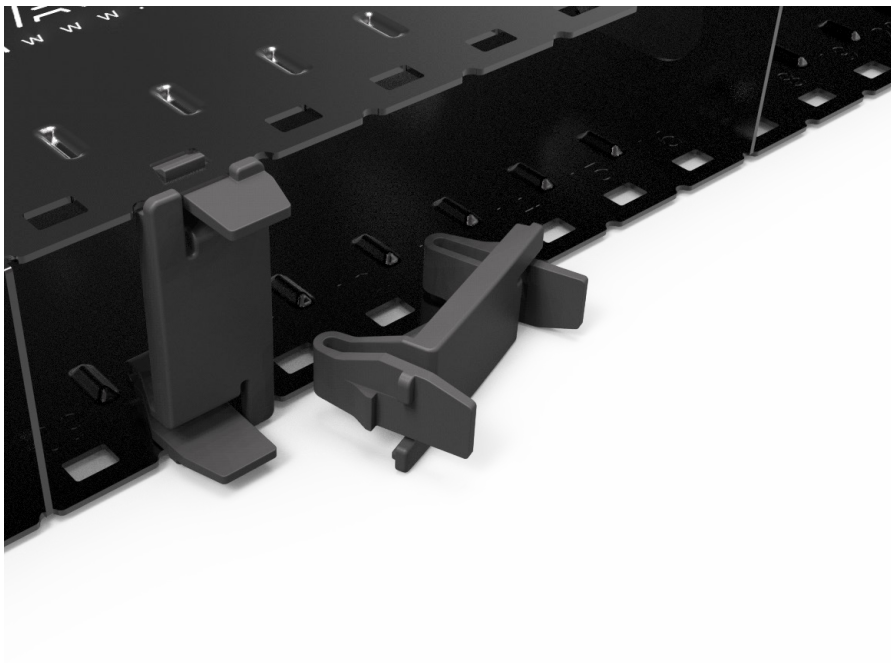

## PATCHBOX Blind Panel

### DESCRIPTION

---

The Blind Panels can be used to cover up unused slots from your PATCHBOX Plus+. This ensures air circulation within your cabinet remains optimised and keeps cool what needs to be kept cool. Simply clip them into the frame and reuse them anytime in another slot.

### TECHNICAL SPECIFICATIONS

---

#### PLASTIC PARTS

Polyoxymethylene POM

#### OPERATING TEMPERATURE RANGE

+10°C - +45°C

#### AMBIENT HUMIDITY NON-CONDENSING

10% - 95%

#### WEIGHT

0.06kg

#### PACKAGING DIMENSIONS

95mm x 102mm x 40mm WxDxH

#### HS-CODE

8538 9099

#### MADE IN THE EU

### ITEMS INCLUDED

---

10 x Blind Panels

### PRODUCT CODE

---

PBXBLIND

# /dev/mount

PATCHBOX Simplify IT

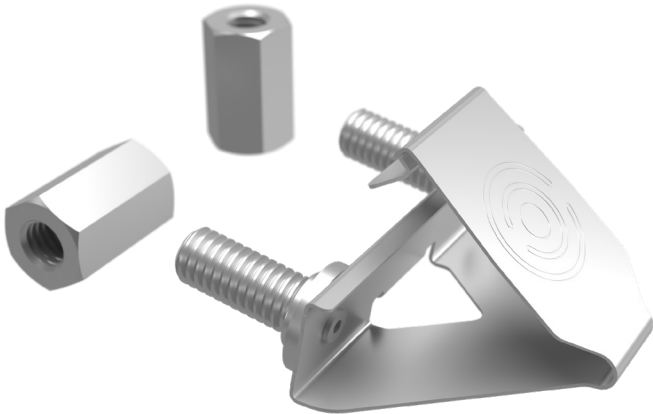

## /dev/mount

### DESCRIPTION

---

The /dev/mount is the fastest solution replacing conventional cage nuts used in server and network racks. Its faster mounting capabilities increases productivity of mounting 19" equipment. The /dev/mount holds equipment securely in place before the nuts are fastened, making hardware mounting a faster and more secure task.

### TECHNICAL SPECIFICATIONS

---

#### PROFILE

Spring steel / aluminium

#### OPERATING TEMPERATURE RANGE

+10°C - +45°C

#### AMBIENT HUMIDITY NON-CONDENSING

10% - 95%

#### WEIGHT

1.33kg

#### PACKAGING DIMENSIONS

23.5mm x 155mm x 70mm WxDxH

#### HS-CODE

7318 1900

#### MADE IN GERMANY

### ITEMS INCLUDED

---

50 x /dev/mount

100 x Dual-sided / reversible Hex-nuts

### PRODUCT CODE

---

DVMNT50

### COMPATIBILITY WITH 19" RAILS

---

The /dev/mount is compatible with 19" rails with square punched holes that are capable of installing standard standard server rails.

