



USER MANUAL

MODEL:

EXT3-21-XR-TR

HDMI & USB 2X1 Switcher Extender



Contents

Introduction	1
Getting Started	1
Overview	2
Typical Applications	4
Defining EXT3-21-XR-TR HDMI & USB 2X1 Switcher Extender	5
Mounting EXT3-21-XR-TR	8
Connecting EXT3-21-XR-TR	9
Connecting to EXT3-21-XR-TR via RS-232	11
Operating and Controlling EXT3-21-XR-TR	12
Principles of Operation	12
Using Front and Rear Panel Buttons	16
Operating via Ethernet	17
Using Embedded Web Pages	20
Routing Operations	23
Setting AV Properties	27
Device Settings and Maintenance	30
Setting Control Gateway Properties	39
Diagnostics	54
Administration	55
Viewing the About Page	60
Upgrading Firmware	61
Technical Specifications	62
Default Communication Parameters	64
Protocol 3000	65
Understanding Protocol 3000	65
Protocol 3000 Commands	66
Result and Error Codes	80

Introduction

Welcome to Kramer Electronics! Since 1981, Kramer Electronics has been providing a world of unique, creative, and affordable solutions to the vast range of problems that confront the video, audio, presentation, and broadcasting professional on a daily basis. In recent years, we have redesigned and upgraded most of our line, making the best even better!

Getting Started

We recommend that you:

- Unpack the equipment carefully and save the original box and packaging materials for possible future shipment.
- Review the contents of this user manual.



Go to www.kramerav.com/downloads/EXT3-21-XR-TR to check for up-to-date user manuals, application programs, and to check if firmware upgrades are available (where appropriate).

Achieving Best Performance

- Use only good quality connection cables (we recommend Kramer high-performance, high-resolution cables) to avoid interference, deterioration in signal quality due to poor matching, and elevated noise levels (often associated with low quality cables).
- Do not secure the cables in tight bundles or roll the slack into tight coils.
- Avoid interference from neighboring electrical appliances that may adversely influence signal quality.
- Position your Kramer **EXT3-21-XR-TR** away from moisture, excessive sunlight and dust.

Safety Instructions



Caution:

- This equipment is to be used only inside a building. It may only be connected to other equipment that is installed inside a building.
- For products with relay terminals and GPIO ports, please refer to the permitted rating for an external connection, located next to the terminal or in the User Manual.
- There are no operator serviceable parts inside the unit.



Warning:

- Use only the power cord that is supplied with the unit.
- To ensure continuous risk protection, replace fuses only according to the rating specified on the product label which is located on the bottom of the unit.

Recycling Kramer Products

The Waste Electrical and Electronic Equipment (WEEE) Directive 2002/96/EC aims to reduce the amount of WEEE sent for disposal to landfill or incineration by requiring it to be collected and recycled. To comply with the WEEE Directive, Kramer Electronics has made arrangements with the European Advanced Recycling Network (EARN) and will cover any costs of treatment, recycling and recovery of waste Kramer Electronics branded equipment on arrival at the EARN facility. For details of Kramer's recycling arrangements in your particular country go to our recycling pages at www.kramerav.com/il/quality/environment.

Overview

EXT3-21-XR-TR is a high-performance, extended-reach HDBaseT 3.0 extender for 4K60Hz (4:4:4) HDMI, USB, Ethernet, PoE power, RS-232, and IR signals over twisted pair, flexibly set as transmitter-side or receiver-side device.

EXT3-21-XR-TR transmitter-side converts all input signals into the transmitted HDBaseT 3.0 signal and extends uncompressed video signals to up 100m (330ft) over CAT copper cables at up to 4K@60Hz (4:4:4) video resolution.

EXT3-21-XR-TR receiver-side is an auto-switcher with HDMI and HDBaseT inputs that receives the HDBaseT 3.0 signal and converts it back into the original input signals. The connected USB 3.1 peripherals, such as a room camera and microphone, are switchable for use of the active USB host, for convenient hybrid meeting operation with both room and online participants.

EXT3-21-XR-TR provides exceptional quality, advanced and user-friendly operation, and flexible control.

Exceptional Quality

- HDMI Signal Switching and Extension – HDCP 2.3, EDID and CEC signals are passed through from the source to the display. Supports HDR10, deep color, x.v.Color™, lip sync, HDMI uncompressed audio channels, Dolby TrueHD, DTS-HD, 2K, 4K, and 3D as specified in HDMI 2.0.
- Flexible USB Switching and Extension– An active USB 3.1 host is connected to the extender at either the transmitter or receiver sides. USB 2.0 signals are extended between the extender transmitter and receiver sides, and switched at the receiver side, enabling connection of the active USB host to both local and remote USB devices, such as camera and audio devices, or HID (Human Interface Devices) mouse or keyboard devices.
- Multi-channel Audio Transmission - Up to 32 channels of digital stereo uncompressed signals for supporting studio-grade surround sound.
- Ethernet Extension - Ethernet interface data flows in both directions, allowing extension of up to 1 Gbps Ethernet connectivity for LAN communication and device control.

Advanced and User-friendly Operation

- Hybrid-meeting Collaborative Switching– Controllable coupled–signals switching of both AV and USB host inputs, for concurrent connection with AV output and room USB devices, allows collaborative hybrid meeting where multiple meeting participants are switched to share their content with both room and online meeting participants.
- Auto Switcher Ease of Use – Automatically plays signal of the plugged source on the connected display, according to user-configured preferences, such as last-connected input.
- Simple and Flexible Control – Remote IP-controller connection, browser operation webpage, local panel buttons, or remotely connected contact-closure buttons, for easy and fully flexible USB host ports selection, and switcher control.
- Convenient Power On/Off Control of Display - Simply press the DISPLAY ON button to toggle on and off the power of the connected display using the configurable control interface and commands, and view display power on/off status at all times via button LED indication.
- Simple Control - Remote IP–controller connection, browser operation webpage, local panel buttons, or remotely connected contact–closure buttons, for easy and fully flexible user ports selection, signals routing, and switcher extender control.

Flexible Connectivity

- High Performance Standard Extender - Professional HDBaseT extender for providing extended–reach signals over twisted–pair copper infrastructures. EXT3–21–XR–TR is a standard extender that can be connected to any market–available HDBaseT–compliant extension product. For optimum extension reach and performance, use recommended Kramer cables.
- HDMI Mirroring - Transmitter–side extender mirrors input HDMI signal to loop output port for connecting a local monitor or an additional unit in a daisy chain.
- Built-in Intelligent Control Gateway – Remote IP–driven intelligent control of connected AV, USB, motorized projector screen and sensor devices via CEC, RS–232, IR, I/O or Relay. Eliminating the need for an external control gateway, this feature reduces installation complexity and costs, to enable easy integration with control systems, such as Kramer Control.
- Audio De-embedding - The digital audio signal passing through to the output, is de–embedded, converted to an analog signal and sent to the stereo balanced analog audio output. This enables playing the audio on a locally connected professional audio system (such as DSP) and speakers, in parallel to playing it on the speakers connected to the AV acceptor device (such as TVs with speakers).
- Bidirectional RS–232 Extension- Serial interface data flows in both directions, allowing data transmission and device control.
- Bidirectional Infrared Extension - interface data flows in both directions, allowing remote control of peripheral devices located at either end of the extended line.
- Secured Operation — Standard IT–grade 802.1x authentication for secured IT LAN connectivity operation.

- Cost-effective Maintenance - Status LED indicators for HDMI, Loop, HDBT, and USB active host ports, facilitate easy local maintenance and troubleshooting.
- Comprehensive and Cost-effective Management – Local panel status LED, remote IP-driven firmware upgrade and management via user-friendly embedded web pages, and remote IP or local serial service and management via API commands and responses communication, for flexible service options and ensure lasting, field proven deployment.
- Easy and Elegant Installation — PoE powering via LAN port connection, or bidirectional PoE powering via HDBaseT port connection, and MegaTOOLS™ fan-less enclosure for dropped-ceiling mounting, on or under table, or side-by-side mounting of 2 units in a 1U rack space with the recommended rack adapter, for easy switcher extender deployment.

Typical Applications

EXT3-21-XR-TR is ideal for the following typical applications:

- Advanced switcher extender building-block for enterprise and education hybrid solutions.
- Upgrading deployed room solutions to hybrid-capable, controllable, and managed solutions.

Controlling your EXT3-21-XR-TR

Control your EXT3-21-XR-TR directly via the front panel push buttons, remote GPIO buttons or:

- Via the IP commands transmitted by a controller and touch screen system, or a browser using built-in user-friendly Web pages.
- By RS-232 serial commands transmitted by a touch screen system, PC, or a serial controller.

Defining EXT3-21-XR-TR HDMI & USB 2X1 Switcher Extender

This section defines EXT3-21-XR-TR.

i Configuring the device as transmitter (Tx) or receiver (Rx, default) is done via the front panel button or the embedded webpages settings (see [Setting Extender Operation Modes](#) on page 33).

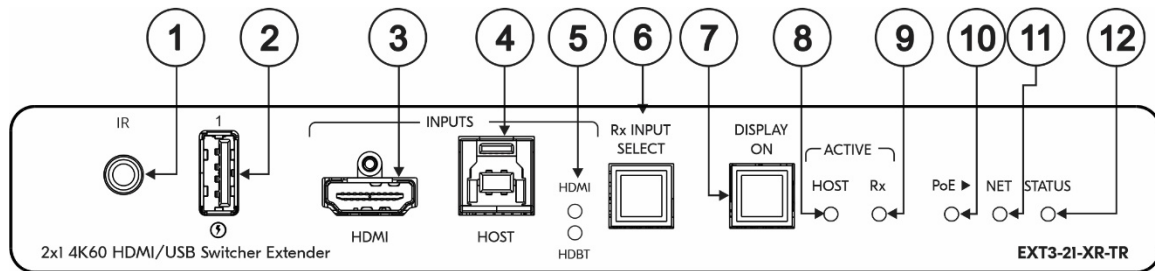

Figure 1: EXT3-21-XR-TR HDMI & USB 2X1 Switcher Extender Front Panel

#	Feature	Function
①	IR 3.5mm Mini Jack Connector	Connect to an external IR emitter to control a local IR-controlled device from the remote extender (for example, EXT3-21-XR-TR). Connect to an IR sensor to control a remote IR-controlled device connected to the remote extender side (for example, EXT3-21-XR-TR).
②	USB-A 3.1	Connect to a USB local peripheral device (for example, a USB camera, a soundbar, microphone and so on).
③	HDMI IN Connector	Connect to an HDMI source.
④	USB-B 3.1 HOST Connector	Connect to a USB host (for example, a laptop) to communicate with the USB peripheral devices (for example, a smart board) connected to USB device ports on either the transmitter or the receiver sides of the extender.
⑤	HDMI and HDBT LEDs	Each input LED, lights green when a source is selected and active, blue when a source is selected but not active, and Off when a source is not selected. Note: On transmitter mode, HDBT LED is always Off.
⑥	Rx INPUT SELECT Button	Press to select an input. Press and hold for a minimum of 10 seconds to switch between Rx↔Tx mode. i Switching between modes initiates Factory Reset.
⑦	DISPLAY ON Button	Press to toggle turning the display on and off. Button LED lights ON after sending a DISPLAY ON message. Button LED lights OFF after sending a DISPLAY OFF message.
⑧	ACTIVE HOST LED	Lights orange when local USB host is active.
⑨	ACTIVE Rx LED	Lights blue on active receiver mode.
⑩	PoE LED	Lights green when the device provides PoE to a connected device.
⑪	NET LED	Indicates networking status:
	LED Color	Indicates
	Dark	No IP address acquired.
	Lights green	A valid IP address has been acquired.
	Flashes green for 60s	A means to identify the device in a system.
	Flashes red/green	IP fallback address has been acquired.

#	Feature	Function	
⑫	STATUS	Indicates device status:	
		LED Color	Indicates
		Off (Dark)	Device is powered and no active source connected.
		Blue	Device is powered, and an active source is connected.
		Green	Device is powered, an active source and acceptor are connected.

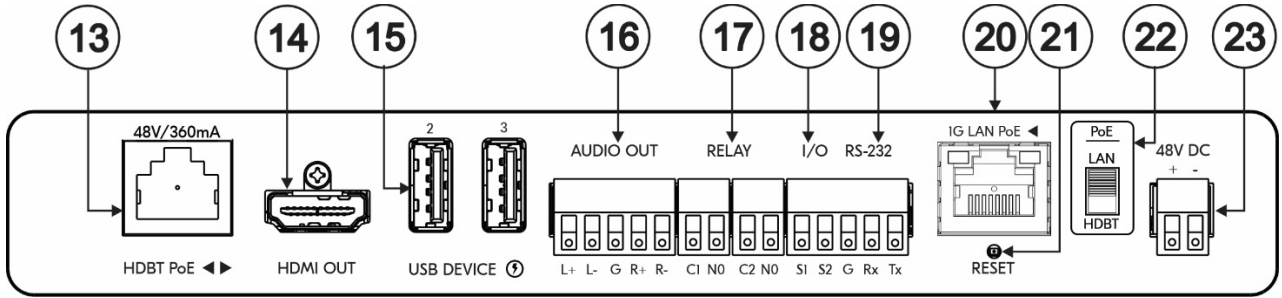

Figure 2: EXT3-21-XR-TR HDMI & USB 2X1 Switcher ExtenderRear Panel

#	Feature	Function
13	HDBT PoE RJ-45 Connector	Connect to the HDBT RJ-45 connector on a paired receiver/transmitter device (for example, a second EXT3-21-XR-TR device) that receives or provides PoE. Note: HDBT provides PoE only when the device is PSU-powered.
14	HDMI OUT Connector	Transmitter Mode: Connect to a local HDMI acceptor (for example, a preview monitor). Receiver Mode: Connect to an HDMI acceptor.
15	USB-A 3.1 (2 & 3) Connectors	Connect to the USB local peripheral devices (for example, a USB camera, a soundbar, microphone and so on).
16	AUDIO OUT 5-pin Terminal Block Connector	Connect to a balanced stereo analog audio acceptor.
17	RELAY (1 & 2) on a 4-pin Terminal Block Connector	Connect to relay-controlled devices (for example, a projector screen).
18	I/O (1 & 2) on a 3-pin Terminal Block Connector (GND is common for I/O and RS-232).	Connect the general input and output ports to connect to I/O-controlled devices (for example, a sensor).
19	RS-232 3-pin Terminal Block Connector	Connect to a serial-controlled device (for example, a projector).
20	1G LAN PoE RJ-45 Connector	Connect to a PC via a LAN. Receives Power (when PoE powered).
21	RESET Recessed Button	For restoring factory default settings, press the RESET button and connect power to device (keep pressing longer than 6sec after power connection) i Set to Receiver mode by default.
22	PoE LAN/HDBT Selection Switch	Select the PoE providing source, either the LAN (default) or the HDBT port.
23	48V DC Power Connector	Connect to the power supply (when not PoE powered).

Mounting EXT3-21-XR-TR

This section provides instructions for mounting **EXT3-21-XR-TR**. Before installing, verify that the environment is within the recommended range:



- Operation temperature – 0° to 40°C (32 to 104°F).
- Storage temperature – -40° to +70°C (-40 to +158°F).
- Humidity – 10% to 90%, RHL non-condensing.

**Caution:**

- Mount **EXT3-21-XR-TR** before connecting any cables or power.

**Warning:**

- Ensure that the environment (e.g., maximum ambient temperature & air flow) is compatible for the device.
- Avoid uneven mechanical loading.
- Appropriate consideration of equipment nameplate ratings should be used for avoiding overloading of the circuits.
- Reliable earthing of rack-mounted equipment should be maintained.
- Maximum mounting height for the device is 2 meters.

Mount EXT3-21-XR-TR in a rack:

- Use the recommended rack adapter
(see www.kramerav.com/product/EXT3-21-XR-TR).

Mount EXT3-21-XR-TR on a surface using one of the following methods:

- Attach the rubber feet and place the unit on a flat surface.
- Fasten a bracket (included) on each side of the unit and attach it to a flat surface. For more information go to www.kramerav.com/downloads/EXT3-21-XR-TR.

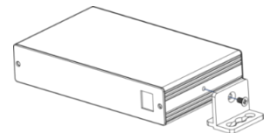

Connecting EXT3-21-XR-TR



Always switch off the power to each device before connecting it to your **EXT3-21-XR-TR**. After connecting your **EXT3-21-XR-TR**, connect its power and then switch on the power to each device.

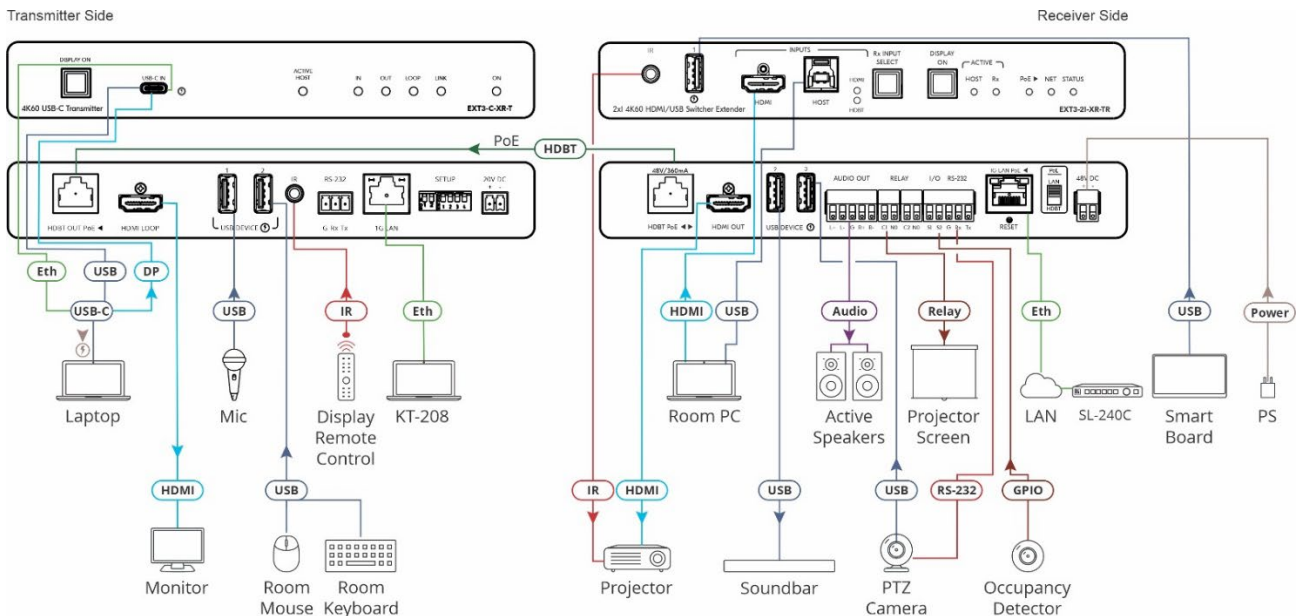

Figure 3: Connecting to the EXT3-21-XR-TR Rear Panels

To connect **EXT3-C-XR-T** to **EXT3-21-XR-TR** as illustrated in the example in [Figure 3](#):

1. Connect the HDBT OUT port on the **EXT3-21-XR-TR** transmitter to the HDBT PoE port (13) on the **EXT3-21-XR-TR** receiver side.
2. On the **EXT3-C-XR-T** transmitter:
 - Connect a USB-C source (for example, a laptop that supports Display Port Alternate Mode) to the USB-C IN connector.
 - Connect an HDMI LOOP connector to an HDMI acceptor.
3. On the **EXT3-21-XR-TR** receiver side:
 - Connect the HDMI OUT connector (14) to an HDMI acceptor (for example, a projector).
 - Connect the HDMI IN connector (3) and HOST USB-B 3.1 port (4) to an input source (for example, a room PC).
4. Connect the USB DEVICE ports:
 - On the transmitter side, ports to USB devices (for example, the room microphone, mouse, and keyboard).
 - On the receiver side, ports (15), to USB devices (for example, a smart board, soundbar and PTZ camera).



USB devices can be connected to both the transmitter and receiver sides, as necessary.

5. To control the projector via IR, connect the following:

- On the **EXT3-C-XR-T** transmitter, connect an IR sensor cable to the IR 3.5mm mini jack.
- On the **EXT3-21-XR-TR** receiver side, connect the IR 3.5mm mini jack (1) to an IR emitter cable and attach the cable emitter side to the IR sensor of the projector.

Point the projector IR remote control to the IR sensor to pass an IR command via HDBT to the projector.

6. To control the room devices via Ethernet, connect the following:

- On the **EXT3-C-XR-T** transmitter LAN port, connect a touch panel designed to operate Kramer Control (for example, **KT-208**).
- On **EXT3-21-XR-TR** receiver side connect the 1G LAN PoE (20) port to LAN.
- Send IP commands via the LAN-connected room controller (for example **SL-240C**) to control via LAN the Room PC, Active speakers, Projector screen, Occupancy detector etc.

7. To serially control the PTZ camera, connect the following:

- On **EXT3-21-XR-TR** receiver side connect the RS-232 port (19) to the PTZ camera.
- Send serial commands from LAN-connected **SL-240C** controller to the camera via extender control gateway.

8. Connect the EXT3-21-XR-TR to power source(s), as follows:

- Switch up the PoE power selector (22) to LAN position and connect the 1G LAN PoE (20) port to a PoE-providing LAN switch.
- Connect the power adapter to the power connector (23) and to the mains electricity.
- Switch down the PoE power selector (22) to HDBT position and receive / provide PoE via the HDBT.



To provide PoE power over the HDBT to the device that is connected to the HDBT port, you need to use a power adapter for powering the **EXT3-21-XR-TR**.

Connecting to EXT3-21-XR-TR via RS-232

You can connect to **EXT3-21-XR-TR** via an RS-232 connection using, for example, a PTZ camera, PC, or display.

EXT3-21-XR-TR features an RS-232 3-pin terminal block connector allowing the RS-232 to control either the **EXT3-21-XR-TR** or a serially controllable device.

Connect the RS-232 terminal block on the rear panel of **EXT3-21-XR-TR** to a PC/controller, as follows:

From the RS-232 9-pin D-sub serial port connect:

- Pin 2 to the TX pin on the **EXT3-21-XR-TR** RS-232 terminal block
- Pin 3 to the RX pin on the **EXT3-21-XR-TR** RS-232 terminal block
- Pin 5 to the G pin on the **EXT3-21-XR-TR** RS-232 terminal block

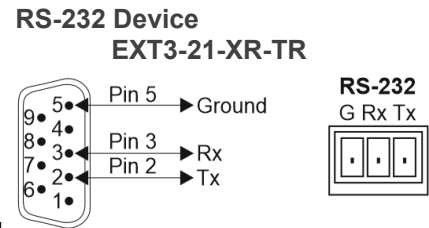

Operating and Controlling EXT3-21-XR-TR

Principles of Operation

- [Pair-synched Coupled AV+USB Auto Switching](#) on page [12](#).
- [Coupled or Individual AV+USB Switching](#) on page [14](#).
- [Flexible EXT3-21-XR-TR Auto Switching Policy](#) on page [15](#).
- [Online Meeting Systems Integration](#) on page [15](#).
- [Routing IP-Driven Control Signals via Built-in Control Gateway](#) on page [15](#). Flexible Remote Buttons Control on page [16](#).
- [EXT3-21-XR-TR Flexible Powering](#) on page [16](#).
- [Single Device Operates as Either Tx or Rx](#) on page [16](#).

Pair-synched Coupled AV+USB Auto Switching

Two paired EXT3-21-XR-TR devices, one set as a transmitter (Tx mode) and the other set as a receiver (Rx mode), feature a default inter-synched pairing operation; No additional control system is needed to synch the pairing operation. This kit-like pair operation provides a cost-effective solution for standard rooms with flexible support for both Room-Based Meeting (RBM) or Bring Your Own Meeting (BYOM) hybrid meeting scenarios, as follows:

RBM scenario:

- Rx-connected room PC/NUC is running the room-based meeting app, such as Zoom Room.
- The room PC/NUC is auto-connected to all room USB devices, both the Tx-connected and Rx-connected USB devices.

- Room-located participants use the Tx-connected room USB devices for collaborating and sharing content via the room PC/NUC.

RBM

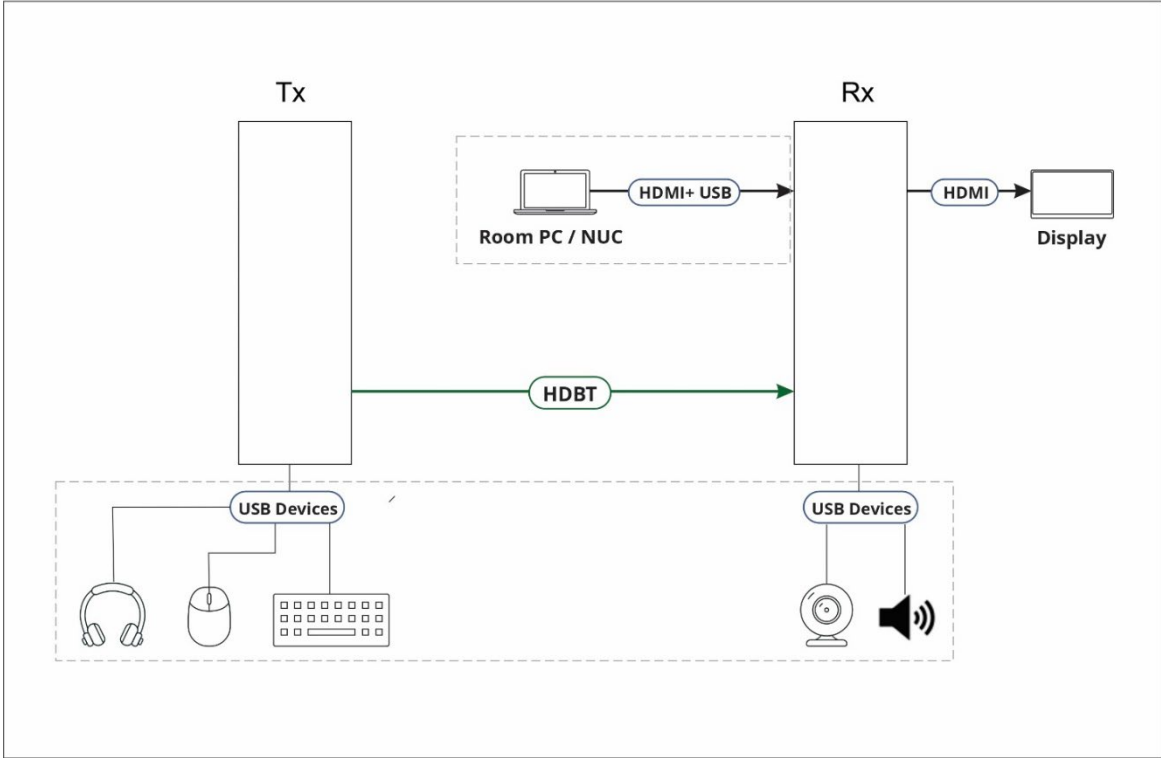

Figure 4: RBM Scenario

BYOM scenario:

- Room-located hybrid meeting participants bring their portable laptops running their own meeting app, such as Microsoft Teams.
- When the laptop connects to Tx, the laptop is auto-connected to all room USB devices, both the Tx-connected and Rx-connected USB devices.

- Room-located participants use the Tx-connected room USB devices for collaborating and sharing content via the laptop.

BYOM

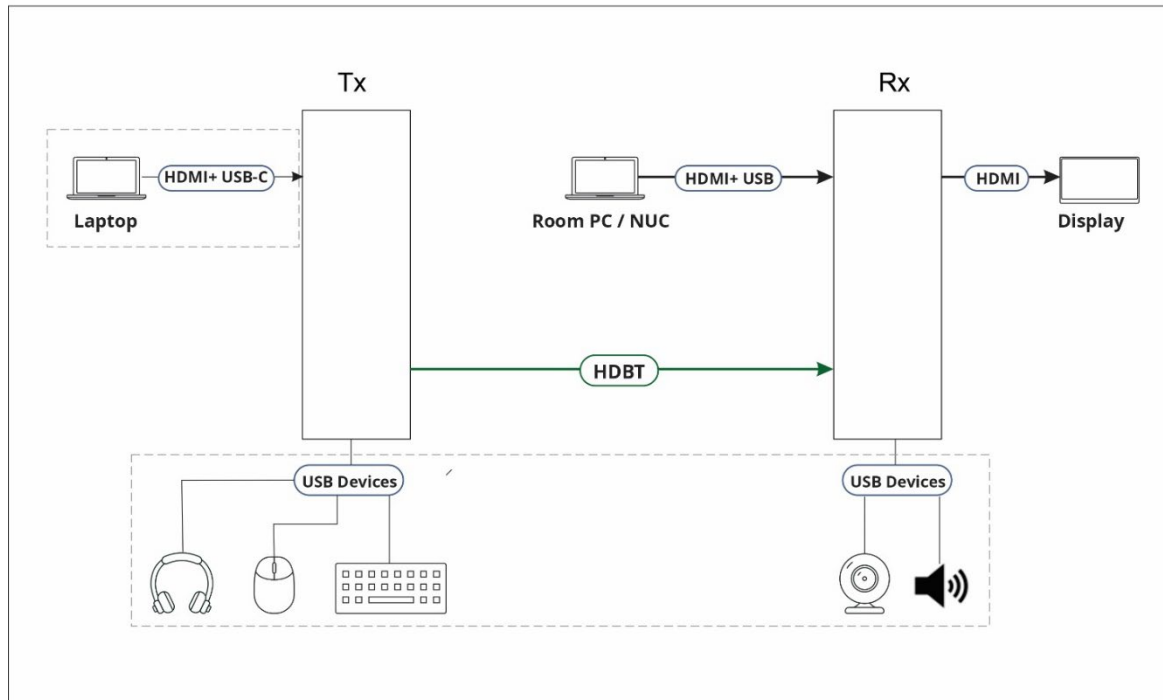

Figure 5: BYOM Scenario



Same synched pair operation applies also to mixed pairs of any Tx and Rx devices, providing that each device supports the pair-synched operation feature

Coupled or Individual AV+USB Switching

When operating **EXT3-21-XR-TR** as a receiver switcher, multi-signal switching of any of the inputs to the AV output and connected USB devices, is configurable to use one of the following operation modes:

- USB follows AV coupled routing (↑) – Selecting an AV input, routes the AV signal to the AV output and connects, in parallel, the input-associated USB host with the connected USB devices.
- USB signal individual routing (↑) – Selecting an AV input, routes the AV signal to the AV output only. The USB host can be independently selected to connect with the connected USB devices.

This is very useful in hybrid sessions, for convenient switching between multiple presenters using either their BYOD laptops and/or connected space PC devices.

(see [Independent USB Host Routing](#) on page 26).

Flexible EXT3-21-XR-TR Auto Switching Policy



This feature is relevant only for the receiver switcher mode.

Set the inputs switching policy to connected output and room devices to:

- Manual – Select an input manually and switching occurs whether input live signals are present or not.
- Auto – Auto Switching selection is performed in either Last Connected or Priority policy.

In Last Connected policy, if the signal on the current input is lost, **EXT3-21-XR-TR** automatically selects the last connected input. The auto-switching delay depends on the configurable signal-lost timeout.

In Priority policy, when the input sync signal is lost for any reason, the input host with a live signal and next in priority is selected automatically. The auto-switching delay depends on the configurable signal-lost timeout. Inputs priority is configurable.



Following power up, the last selected input, either HDMI or HDBT, is active.

(see [Setting the Auto-Switching Policy](#) on page [27](#)).

Online Meeting Systems Integration

USB device ports can be set to auto-disconnect following presenter disconnection, to allow smooth integration and auto-activation of connected online meeting room systems.

(see [Auto-disconnecting a USB Device on Inactive Host](#) on page [37](#)).

Routing IP-Driven Control Signals via Built-in Control Gateway

- Remote IP connected clients can communicate and control (send commands, and receive responses and notifications), via the LAN, using the **EXT3-21-XR-TR** built-in and I/O control gateway:
 - RS-232 commands, to control devices connected to **EXT3-21-XR-TR** serial control ports or HDBT serial channels. The built-in control gateway sends the serial control commands (converted from the client received IP messages) to the serially controlled connected devices and distributes their received responses to all connected clients.
 - IR commands, to control devices connected to **EXT3-21-XR-TR** IR control ports or HDBT IR channels. The built-in control gateway sends the IR control commands (converted from the client received IP messages) to the IR controlled connected devices.
 - Relay commands, to control devices connected to **EXT3-21-XR-TR** relay control ports. The built-in control gateway sends the relay control commands (converted from the client received IP messages) to the relay controlled connected devices.
 - Send or receive I/O digital triggers or detected triggers, to I/O control devices connected to **EXT3-21-XR-TR** control ports. The built-in control gateway sends the

I/O control commands (converted from the client received IP messages) to the I/O controlled connected devices and distributes their received detected triggers to all connected clients.

(see [Setting Control Gateway Properties](#) on page 39).

Flexible Remote Buttons Control

Remote contact-closure buttons can be connected to the I/O ports, for easy end user control of device functions by button press and release operation. Flexible configuration of button press/release actions and latching (default) or momentary operation mode, enable simple and custom control according to user needs.

(see [Configuring Remote Buttons](#) on page 49).

EXT3-21-XR-TR Flexible Powering

The **EXT3-21-XR-TR**, when connected to the power supply, can supply power to the connected transmitter / receiver via HDBT. The **EXT3-21-XR-TR**, can also accept power from either LAN or HDBT.

Single Device Operates as Either Tx or Rx

Using the front panel button or the embedded webpage, enables the **EXT3-21-XR-TR** to be easily set to operate either as a transmitter (Tx) or receiver (Rx).

(see [Setting Extender Operation Modes](#) on page 33)

Using Front and Rear Panel Buttons

EXT3-21-XR-TR front panel buttons enable the following actions:

- Switching between Rx↔Tx mode.



Switching between modes initiates Factory Reset.

- Selecting an INPUT, when in Rx mode.
- Turning the display on or off via the DISPLAY ON or sending on or off commands that are configured via the UI (see [Associating Commands to DISPLAY ON/OFF \(Custom control\)](#) on page 50).
- Resetting device to its factory settings (for additional instructions on resetting and resetting device (see [Resetting and Restarting Device](#) on page 34).

Operating via Ethernet

- Directly to the PC using a crossover cable (see [Connecting Ethernet Port Directly to a PC](#) on page 17).
- Via a network switch or router, using a straight-through cable (see [Connecting Ethernet Port via a Network Hub](#) on page 19).



If you want to connect via a router and your IT system is based on IPv6, speak to your IT department for specific installation instructions.

Connecting Ethernet Port Directly to a PC

You can connect the Ethernet port of **EXT3-21-XR-TR** directly to the Ethernet port on your PC using a crossover cable with RJ-45 connectors.



This type of connection is recommended for identifying **EXT3-21-XR-TR** with the factory configured default IP address.

After connecting **EXT3-21-XR-TR** to the Ethernet port, configure your PC as follows:

1. Click **Start > Control Panel > Network and Sharing Center**.
2. Click **Change Adapter Settings**.
3. Highlight the network adapter you want to use to connect to the device and click **Change settings of this connection**.

The Local Area Connection Properties window for the selected network adapter appears as shown in [Figure 6](#).

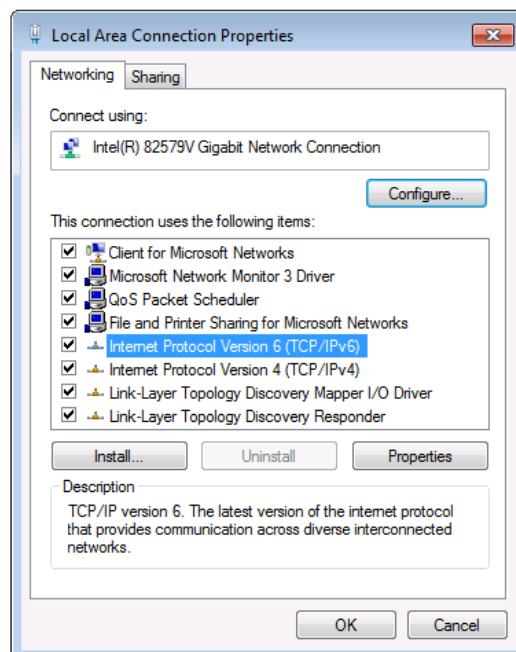

Figure 6: Local Area Connection Properties Window

4. Highlight either **Internet Protocol Version 6 (TCP/IPv6)** or **Internet Protocol Version 4 (TCP/IPv4)** depending on the requirements of your IT system.

5. Click **Properties**.

The Internet Protocol Properties window relevant to your IT system appears as shown in [Figure 7](#) or [Figure 8](#).

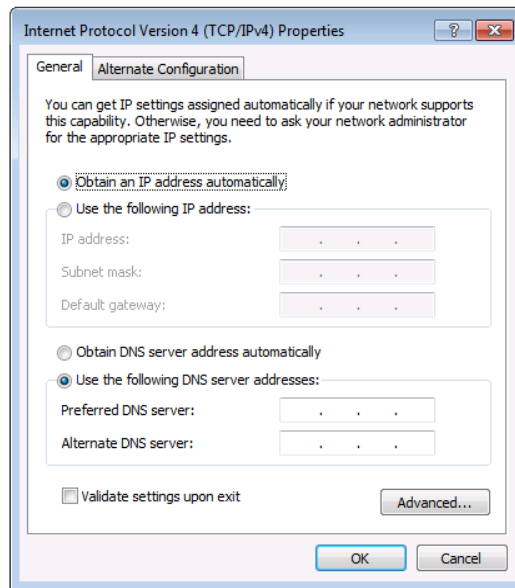

Figure 7: Internet Protocol Version 4 Properties Window

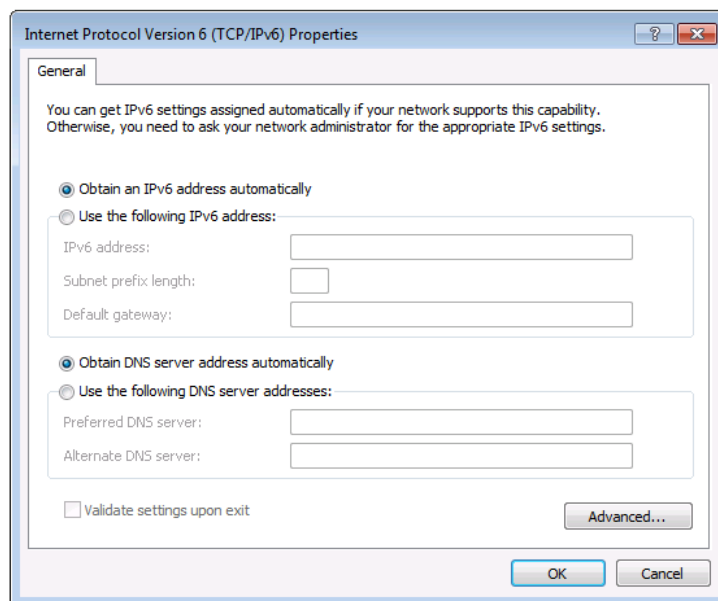

Figure 8: Internet Protocol Version 6 Properties Window

6. Select **Use the following IP Address** for static IP addressing and fill in the details as shown in [Figure 9](#).

For TCP/IPv4 you can use any IP address in the range 192.168.1.1 to 192.168.1.255 (excluding default 192.168.1.39 fallback address) that is provided by your IT department.

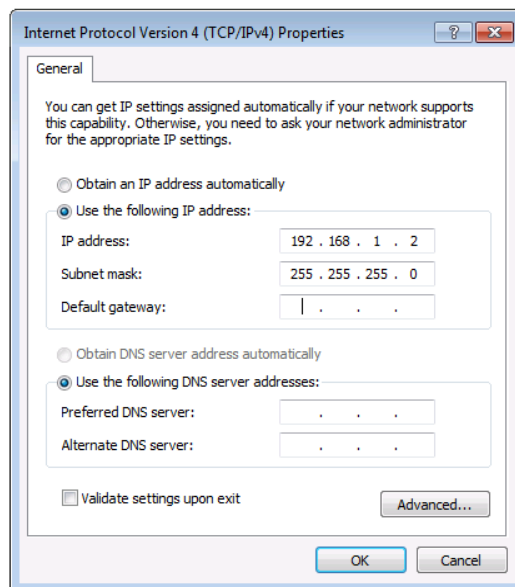

Figure 9: Internet Protocol Properties Window

7. Click **OK**.
8. Click **Close**.

Connecting Ethernet Port via a Network Hub or Switch

You can connect the Ethernet port of **EXT3-21-XR-TR** to the Ethernet port on a network hub or using a straight-through cable with RJ-45 connectors.

Configuring Ethernet Port

You can set the Ethernet parameters via the embedded Web pages.

Discovering and acquiring IP address

EXT3-21-XR-TR includes IP address auto-acquiring policy via LAN-connected DHCP server by default. When no DHCP server is detected, a fallback static IP address of 192.168.1.39, and 255.255.255.0 subnet mask (class C), is assigned until an IP address is acquired via the DHCP server.

For more information, refer to Product Page Technical Note in www.kramerav.com/product/EXT3-21-XR-TR.

Using Embedded Web Pages

EXT3-21-XR-TR enables you to configure settings via Ethernet using built-in, user-friendly web pages. The Web pages are accessed using a Web browser and an Ethernet connection.

 You can also configure **EXT3-21-XR-TR** via Protocol 3000 commands (see [Protocol 3000 Commands](#) on page 66).

Before attempting to connect:

- Perform the procedure in (see [Operating via Ethernet](#) on page 17).
- Ensure that your browser is supported.

The following operating systems and Web browsers are supported:

Operating Systems	Browser
Windows 7	Chrome
Windows 10	Edge
	Chrome
Mac	Safari
iOS	Safari
Android	N/A

 If a web page does not update correctly, clear your Web browser’s cache.

 Check that Security/firewalls are not blocking HTTP traffic between the device and the user PC.

To access the web pages:

1. Enter the IP address of the device in the address bar of your internet browser (default = 192.168.1.39).

If security is enabled, the Login window appears.

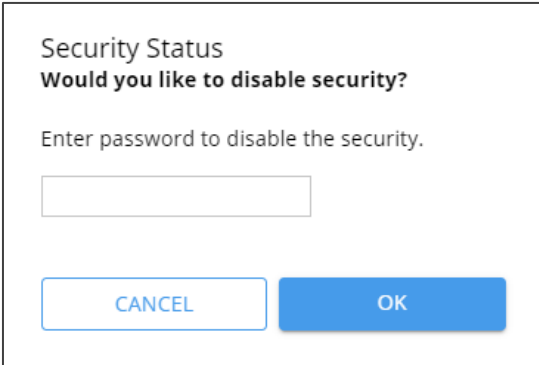

Figure 10: Embedded Web Pages Login Window

- 2. Enter the Username (default = Admin) and Password (default = Admin) and click **Sign in**. The default web page appears.

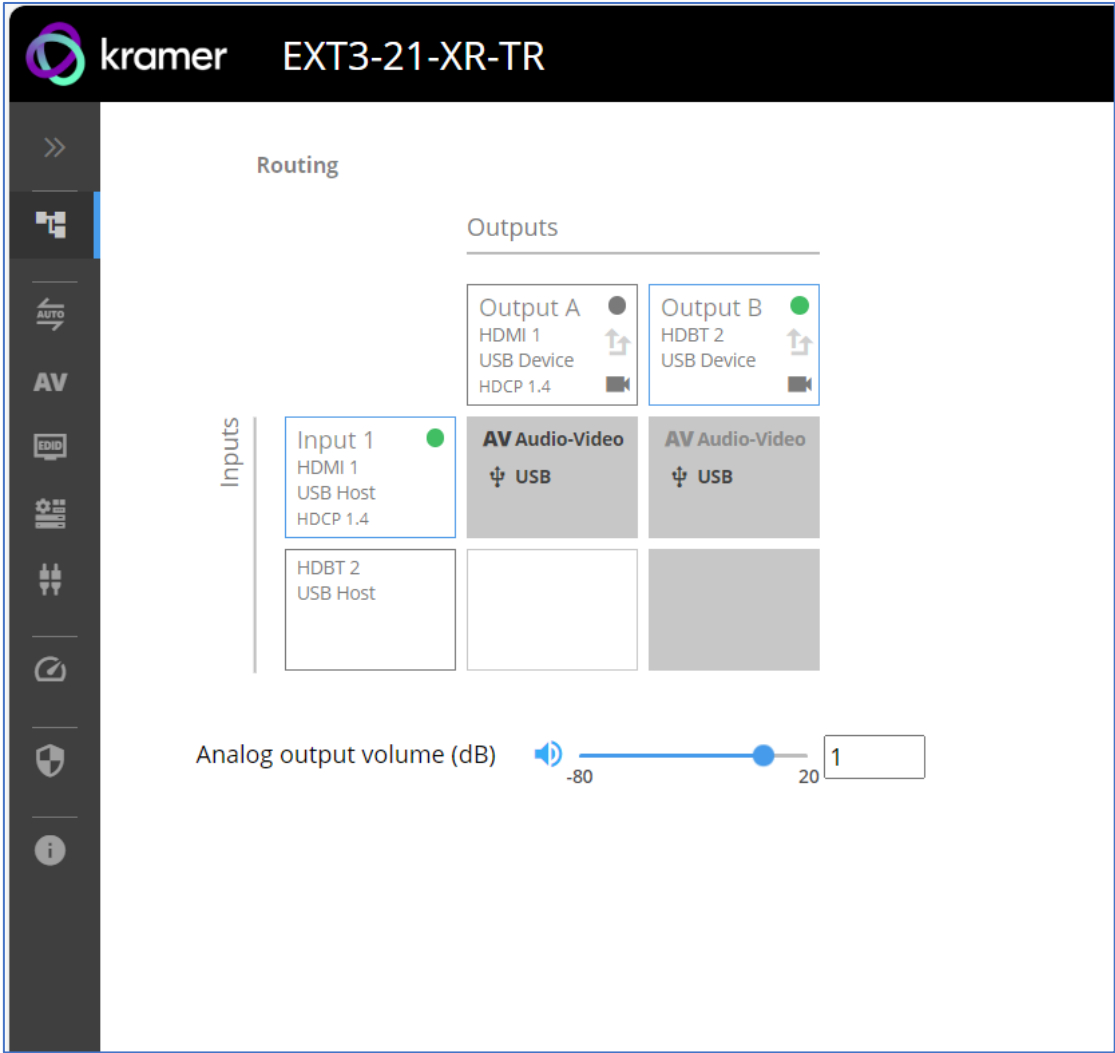

Figure 11: Default Landing Page

- Click the arrow at the top of the navigation list to view the menu items in detail.

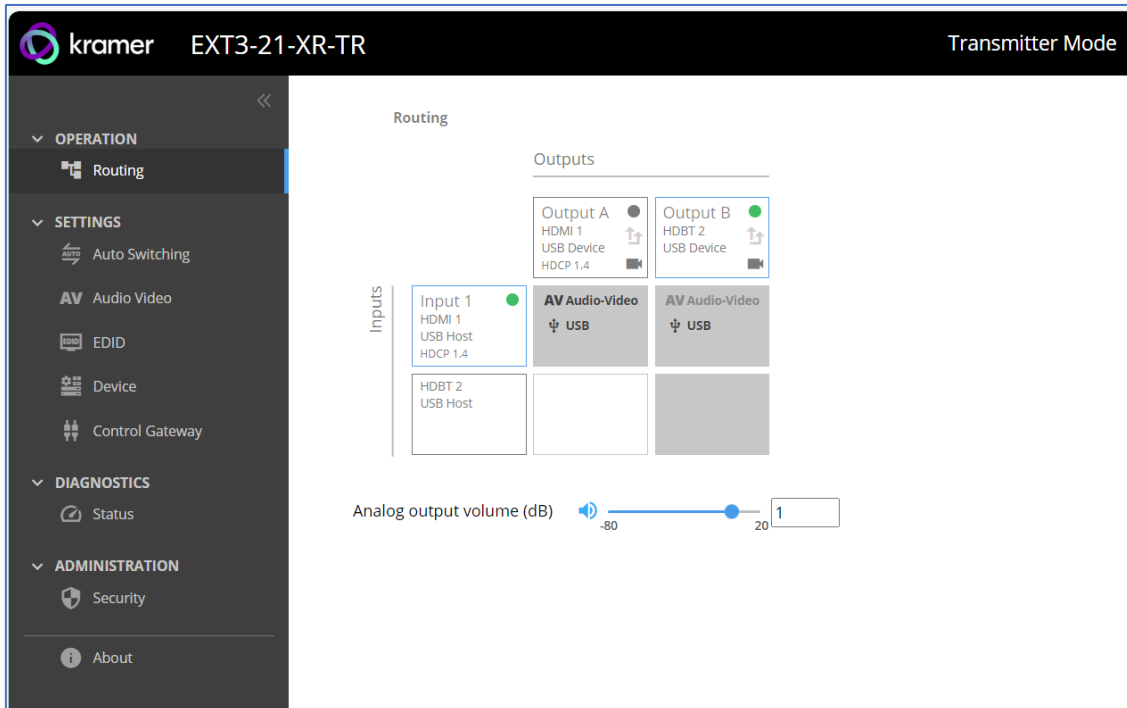

Figure 12: Pages and Tabs Navigable List

- Click the Navigation Pane on the left side of the screen to access the relevant web page.



Using the embedded webpage, the **EXT3-21-XR-TR** can be easily set to operate either as a transmitter (Tx) or receiver (Rx). (see [Setting Extender Operation Modes](#) on page [33](#)).

EXT3-21-XR-TR web pages enable performing the following actions:

- **Error! Not a valid bookmark self-reference.** on page [22](#).
- [Setting AV Properties](#) on page [27](#).
- [Device Settings and Maintenance](#) on page [30](#).
- [Setting Control Gateway Properties](#) on page [39](#).
- [Diagnostics](#) on page [54](#).
- [Administration](#) on page [55](#).
- [Viewing the About Page](#) on page [60](#).

Routing Operations





This section details the following actions:

- [Routing an Input to an Output](#) on page [23](#).
- [Setting Analog Audio Output Volume Level](#) on page [27](#).

Routing an Input to an Output

When routing any of the inputs to the output, you can set both inputs to route the AV signal together with the USB signal (USB follows video coupled routing) or to independently route each individual signal.

Routing cross-point grid for Tx and Rx operation modes (see [AV Routing](#) on page [24](#) & [USB Routing](#) on page [24](#)), enable either coupled or independent AV and USB signals routing, as follows:

Extender Operation Mode	AV Routing	USB Host Routing
Tx	Inputs: 1xHDMI	Input Hosts: 1xUSB-B (local) + 1xHDBT (remote Rx)  Routing between local and remote active USB Hosts.
	Outputs: 1xHDBT, Mirrored 1xHDMI	Output Devices: 3xUSB-A (local) + Rx USB devices (remote)  USB local devices are always connected to active Host. Remote USB devices connection to local active Host is configurable (see Figure 14 & Figure 15).
Rx	Inputs: 1xHDMI, 1xHDBT	Input Hosts: 1xUSB-B (local) + 1xHDBT (remote Tx)  Routing between local and remote active USB Hosts.
	Outputs: 1xHDMI	Output Devices: 3xUSB-A (local) + Tx USB devices (remote)  USB local devices are always connected to active Host. Remote USB devices connections to local active Host is configurable (see Figure 14 & Figure 15).
 Active Host connects to all local and remote devices.		

AV Routing

To route the video inputs to the outputs:

1. Go to the Routing Operation page.

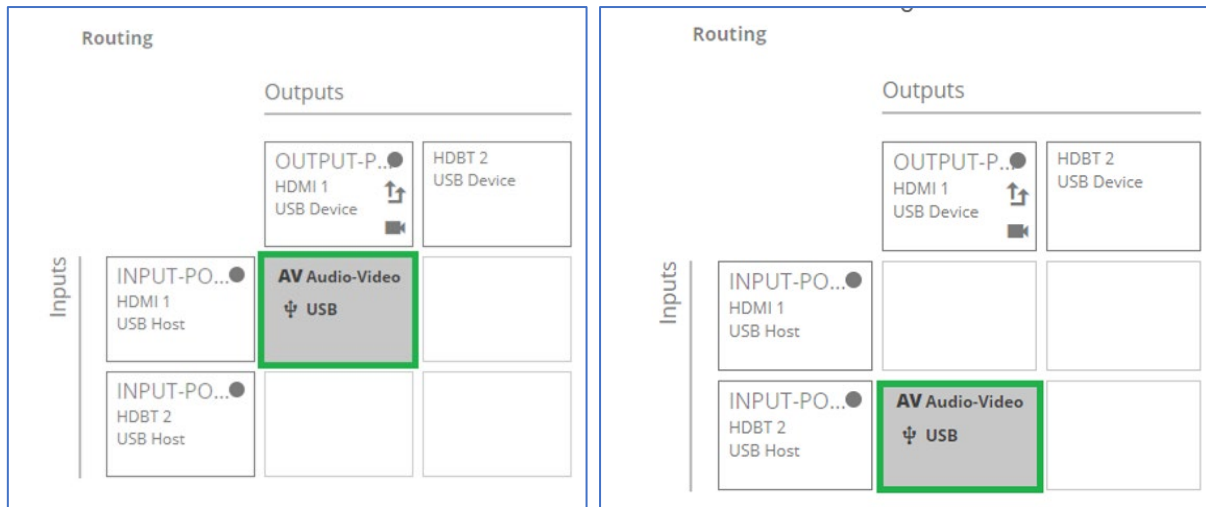



Figure 13:Rx Mode Routing Page

2. Perform the following functions:

- Click an Input/Output cross-point (see [Routing AV and USB Host Signals](#) on page 26).



A green light on a button indicates a connected source/acceptor.

- Click  to activate USB following video coupled routing.
- Click  to stop/play the output signal.

An input is routed to the output.

USB Routing

To Select Local Host as Active or Remote Host as Active

Whether in Tx or Rx mode, selecting the correct button in the embedded webpage determines if your local or remote host is active.



USB standard compliance allows only a single active USB host (local or remote).

To select Local Active Host:

1. Go to the Routing Operation page.
2. Click the Input/Output cross-point **HDMI 1USB Host** shown in (see [Figure 14](#)).



Using the local active host, you now control USB devices connected to all **local** devices.

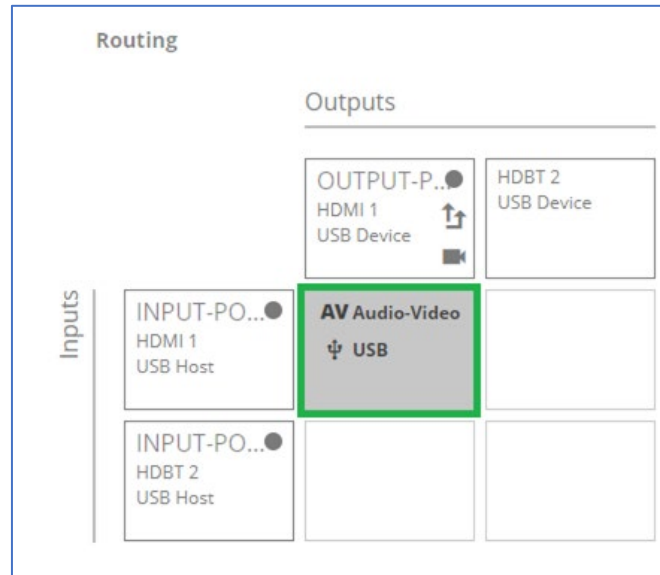

Figure 14: Selecting Local Active Host for Connection to Local USB Devices Only

3. To select connection to local active host for both local and remote USB devices:
 - Click the Input/Output cross-point **HDBT 2 USB Host** in addition to selected **HDMI 1USB Host** (see [Figure 15](#)).



Using the local active host, you now control all USB connected devices connected to all local and remote devices.

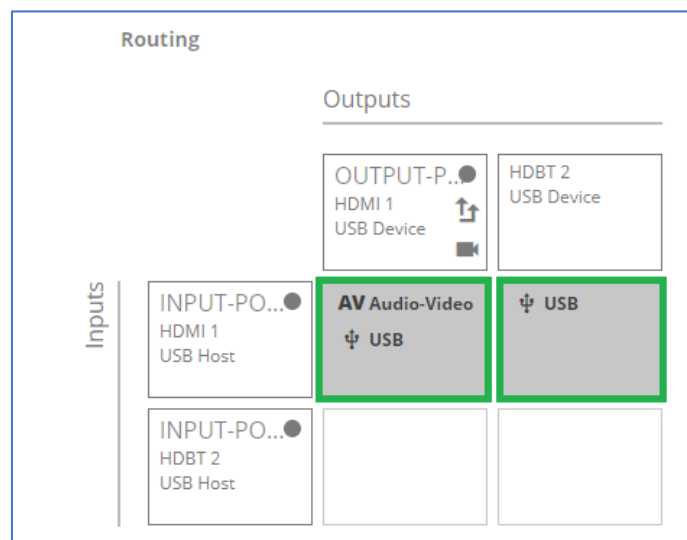

Figure 15: Selecting Local Active Host for Connection to both Local and Remote USB Devices

Depending on USB active host configuration, you control local and remote USB devices via active local host.

To select Remote Active Host:

1. Go to the Routing Operation page.
2. Click the Input/Output cross-point **HDBT 2 USB Host** shown in ([Figure 16](#)).

Using the remote active host, you now remotely control all USB connected devices connected to all local and remote devices.

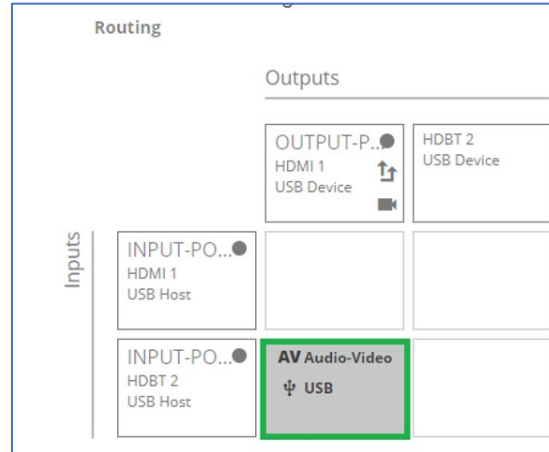

Figure 16: Selecting Remote Active Host

Routing AV and USB Host Signals

EXT3-21-XR-TR enables switching any of the inputs to the output in one of the following operation modes:

- USB follows AV coupled routing (↑) – Selecting an input, routes the HDMI signal to the output and associates the USB devices to that selected input USB host.
- USB signal individual routing (↑) – Selecting an input, routes the HDMI signal to the output. The independently selected USB host, either the local or remote host, is connected to both local and remote USB device ports.

Independent USB Host Routing

In the following example, USB routing does not follow video, so you can independently select the AV signal on input 1 and the USB signal on input 2. This means that the HDMI input 2 AV signal is routed to the AV output and the USB devices are associated with the remote HDBT USB host.

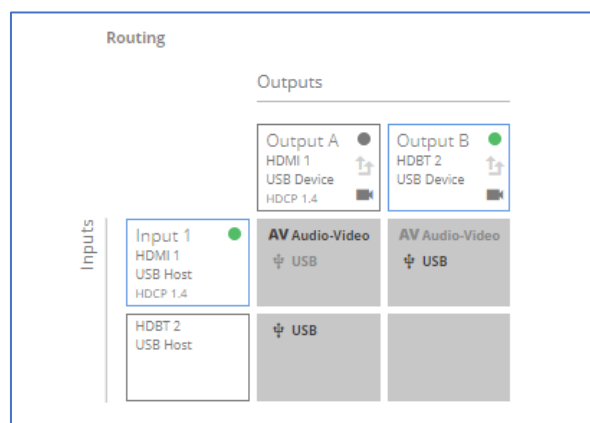



Figure 17: Independent routing of USB Host and AV Signal

Setting Analog Audio Output Volume Level

To set the audio output volume level:

1. Go to the Routing Operation page.
2. Next to Analog output volume (dB) click .
3. Set the audio volume level:
 - using the slider next to Analog output volume (dB, from -80 to 20), or
 - enter the audio output volume in the text box.

Audio level is set.

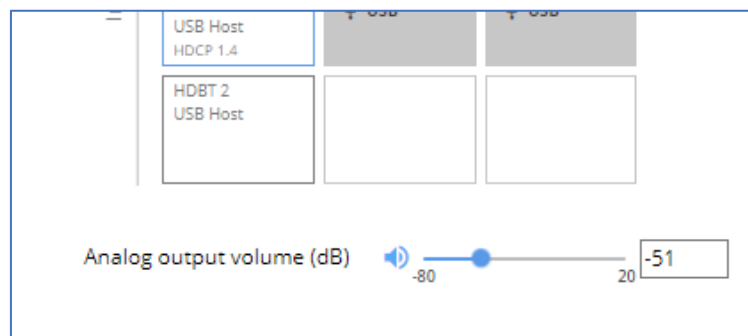

Figure 18: Setting Audio Output Volume Level

Video and USB host inputs are routed to the outputs and USB devices.

Setting AV Properties

- [Setting the Auto-Switching Policy](#) on page [27](#).
- [Settings AV Signal Properties](#) on page [28](#).
- [Managing EDID](#) on page [29](#).

Setting the Auto-Switching Policy



This section is applicable for Receiver side only.

To set the AV auto-switching policy:

1. Go to the Auto switching tab.
2. Next to the Selection Mode drop-down box, select the auto switching policy: **Manual**, **Last Connected** or **Priority**.

AV auto-switching policy is set.

To change AV Host Input Priorities:

1. Go to the Auto switching tab.
2. Next to the Selection Mode drop-down box, select **Priority**.

3. Click and drag a host input between high and low to change the priorities.

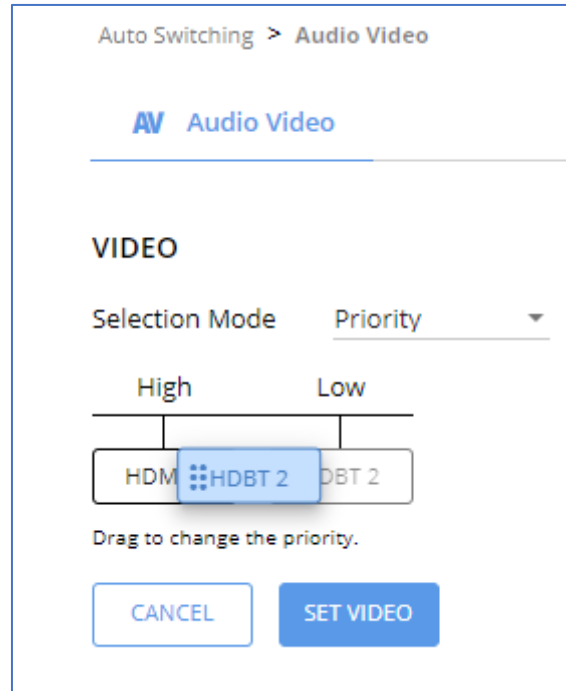

Figure 19: Changing Input Priorities

4. Click **SET VIDEO**.

AV input priorities are set.

Settings AV Signal Properties

EXT3-21-XR-TR enables setting the audio and video signal properties.



AV properties related to HDCP and CEC signals are not configurable. They are passing through:

- Transmitter-side: Between HDMI input and HDBT output.
- Receiver-side: Between HDMI or HDBT input and HDMI output.

To set audio and video signal:

1. Go to the Audio Video Settings page. The Audio Video Settings page appears.

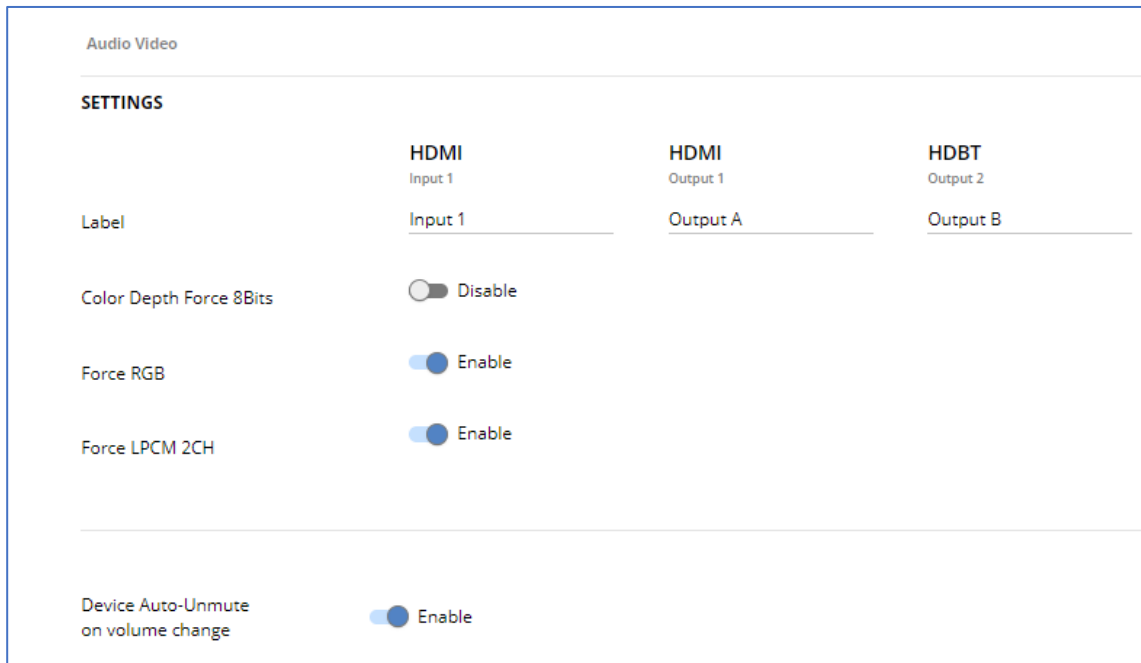

Figure 20: Audio Video Settings

Perform the following actions:

- Label – Change the name of an input or the output as it appears on the Routing page and EDID management page.
- Color Depth Force 8Bits – **Enable** or **Disable** (default)
- Force RGB– **Enable** or **Disable** (default).
- Force LPCM 2CH – **Enable** or **Disable** (default)
- Device Auto-Unmute on volume change – When enabled (default), changing the volume will auto-unmute the audio output.

Audio and video settings are configured.

Managing EDID

EXT3-21-XR-TR enables you to copy an EDID from one of several different sources to the inputs.

To copy the EDID to the inputs:

1. Go to the EDID Management page.

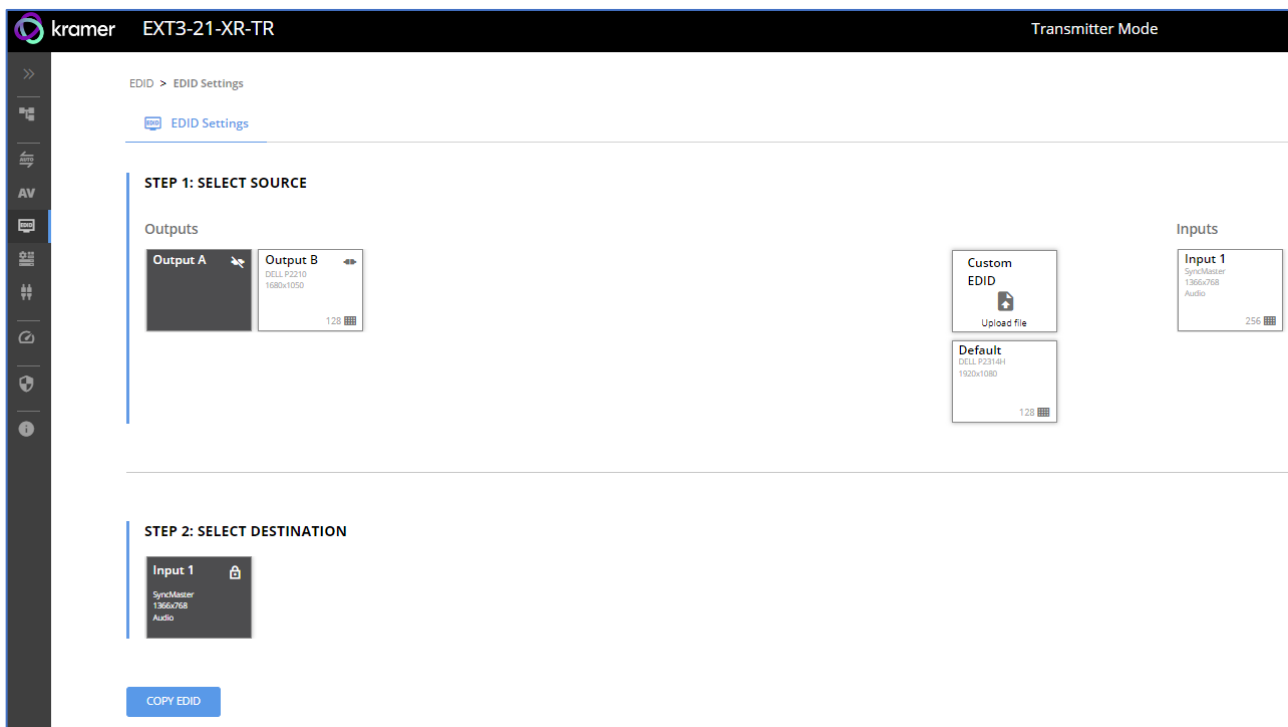

Figure 21: EDID Management Page

2. Under Step 1, select the EDID source (the output, any of the inputs, default or custom EDID file).
3. Under Step 2, select one or more inputs as the destination for copying the EDID.
4. Click **COPY EDID**.

The EDID is copied.

Device Settings and Maintenance

This section details the following actions:

- [Device Profile and Maintenance](#) on page [32](#).
- [Settings Networking Properties](#) on page [36](#).

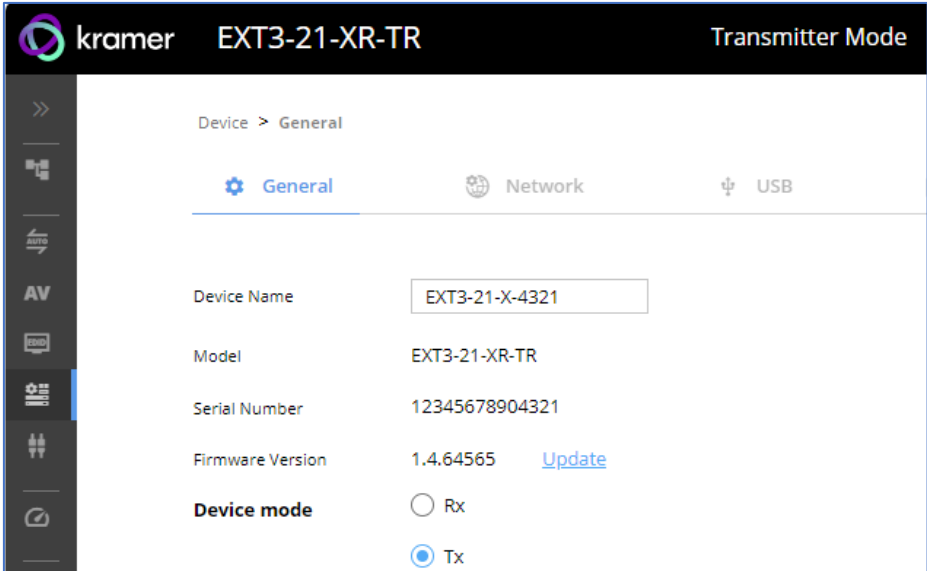

Figure 22: Updated Mode

The extender device operation mode was selected and implemented.

Device Profile and Maintenance

Changing Device Name

EXT3-21-XR-TR enables you to change the DNS name of the device.

To change the device name:

1. Go to the Device > General page.

Device > General

General Network USB Time and Date

Device Name

Model EXT3-21-XR-TR

Serial Number 12345678901

Firmware Version R1.1.17317 [Update](#)

Device mode Rx Tx

GLOBAL SYSTEM SETTINGS

DEVICE RESTART EXPORT FLAG ME

FACTORY RESET IMPORT

CANCEL SAVE

Figure 23: Device > General Tab

2. Under General Preferences, change the device name and click **SAVE**.

The device name is changed.

Setting Extender Operation Modes

 This section applies to both Tx (transmitter) and Rx (receiver) modes unless otherwise noted.

To switch between extender Tx or Rx modes

1. Go to the Device>General tab.
2. Select either Rx or Tx.

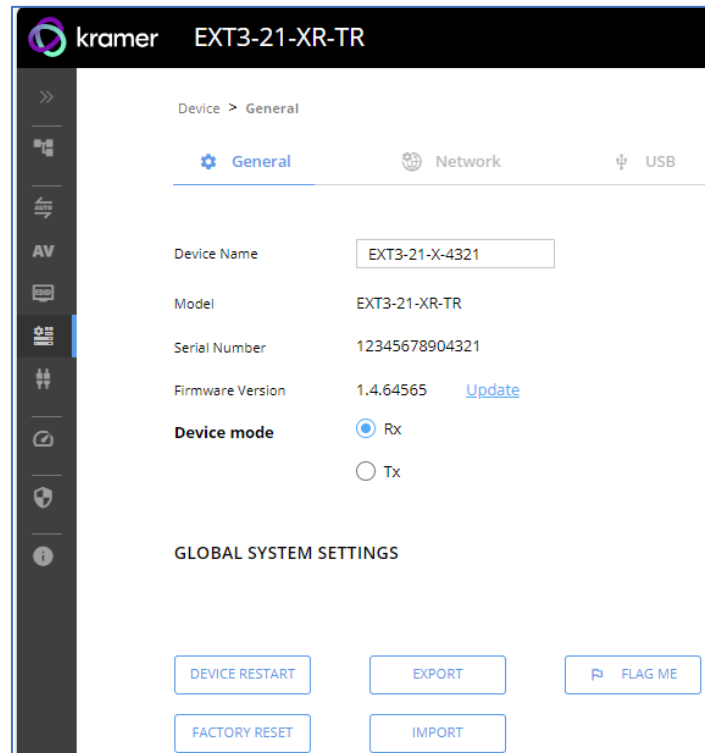

Figure 24: Device Tab: Switching Rx / Tx Operation Mode

3. Click **Save**. A device Reset message appears.

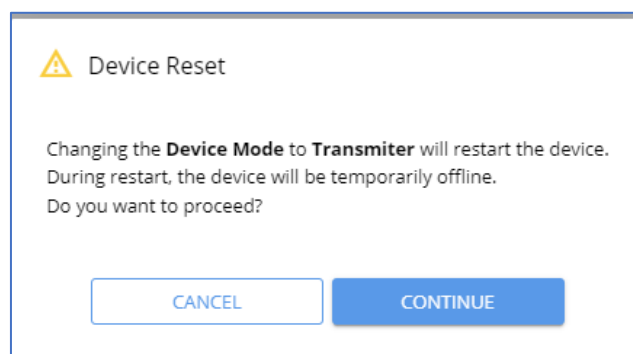



Figure 25: Device Reset Warning Message

4. Click CONTINUE. The extender device is switching operation modes.

 This can take up to 60 seconds.

5. The extender device mode indication, at the top bar, shows the newly selected mode.

Upgrading Firmware

To upgrade the device firmware:

1. Go to the **Device > General** page ([Figure 23](#)).
2. Under General, click **Update**, open the relevant firmware file, and follow the instructions. The upgrade takes approximately 30-60 seconds.



- During FW upgrade, the device continues to operate, but the device UI and protocol 3000 communication are inactive. When device restarts, the status LED is lit, and HDMI output signal is disconnected until restart completes.

Firmware is updated.

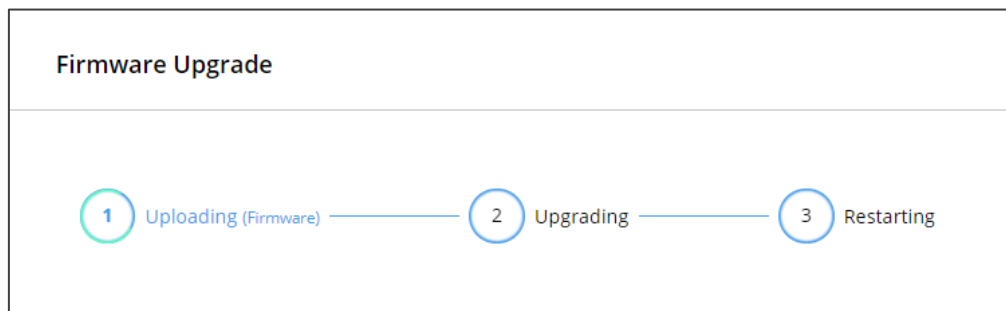

Figure 26:Firmware Upgrade Process

Resetting and Restarting Device

Two types of resets can be performed:

- Restart – Reboots your device and keeps all your device settings, including the IP address and password.
- Reset – Reboots your device and restores all factory settings including input/output definitions, switching configuration, IP address and password (a DHCP-acquired IP address is retained).

To restart the device:

- Click **DEVICE RESTART** on the **Device > General** page ([Figure 23](#)).

To perform a factory reset on the device, use one of the following actions:

- Click **FACTORY RESET** on the **Device > General** page ([Figure 23](#)).
- Using protocol 3000 commands, send FACTORY command then RESET commands.
- On the rear panel, press and hold the RESET button while connecting the power for several seconds.

Exporting and Importing a Configuration File

EXT3-21-XR-TR enables you to export and store (in connected browsing PC storage) a configuration file, that records all current device settings except the routing operation setup. The stored file can then be imported to the same or different **EXT3-21-XR-TR** device to load the recorded settings, for configuration backup and/or solution-replication purposes.

Exporting a Configuration File

To export a configuration file of the current device settings:

1. Go to the **Device > General** page ([Figure 23](#)).
2. Under Global System Settings, click **EXPORT**.
3. Select the storage location on your computer to save the configuration file and click **SAVE**.

The configuration file is exported and saved.

Importing a Configuration File

To import a configuration file of the current device settings:

1. Go to the **Device > General** page ([Figure 23](#)).
2. Under Global System Settings, click **IMPORT**.
3. Select the relevant configuration file from your computer storage and click **SAVE**.

The configuration file is imported and the device restarts with the settings from the configuration file.

Identifying Your Device

To identify the device using a supporting discovery system:

1. Go to the **Device > General** page ([Figure 23](#)).
2. Under Global System Settings, click **FLAG ME**. NET LED flashes.



FLAG ME indication turns off after 60 seconds.

The device is identified by the discovery system.

Settings Networking Properties



By default, DHCP is set to on. The IP address shows the actual IP address acquired from the DHCP server, or the auto-acquired fallback IP address when there is no DHCP server detection.

To configure network settings:

1. Go to the **Device > General** page ([Figure 23](#)).
2. Select the **Network** tab.

The network page appears.

Setting	DHCP On	DHCP Off
DHCP	On	Off
MAC Address	00-1d-56-03-8d-17	00-1d-56-01-56-1b
IP Address	192.168.1.39	192.168.117.20
Mask Address	255.255.255.0	255.255.0.0
Gateway Address	172.17.136.254	192.168.0.1

Figure 27: Device Settings > Network Tab (DHCP On / DHCP Off)

3. Change settings as needed.
If required, Set to **DHCP** (default) or static IP address resolution modes.
4. When in Static IP mode, perform the following actions:
 - Change the IP address.
 - Change the Mask address.
 - Change the Gateway address.
5. Click **SAVE**.

Network settings are defined.

Auto-disconnecting a USB Device on Inactive Host

When a host becomes inactive, you can automatically disconnect one or multiple USB devices.

To define auto-disconnection:

1. Go to the **Device > General** page ([Figure 23](#)).
2. Select the USB tab.

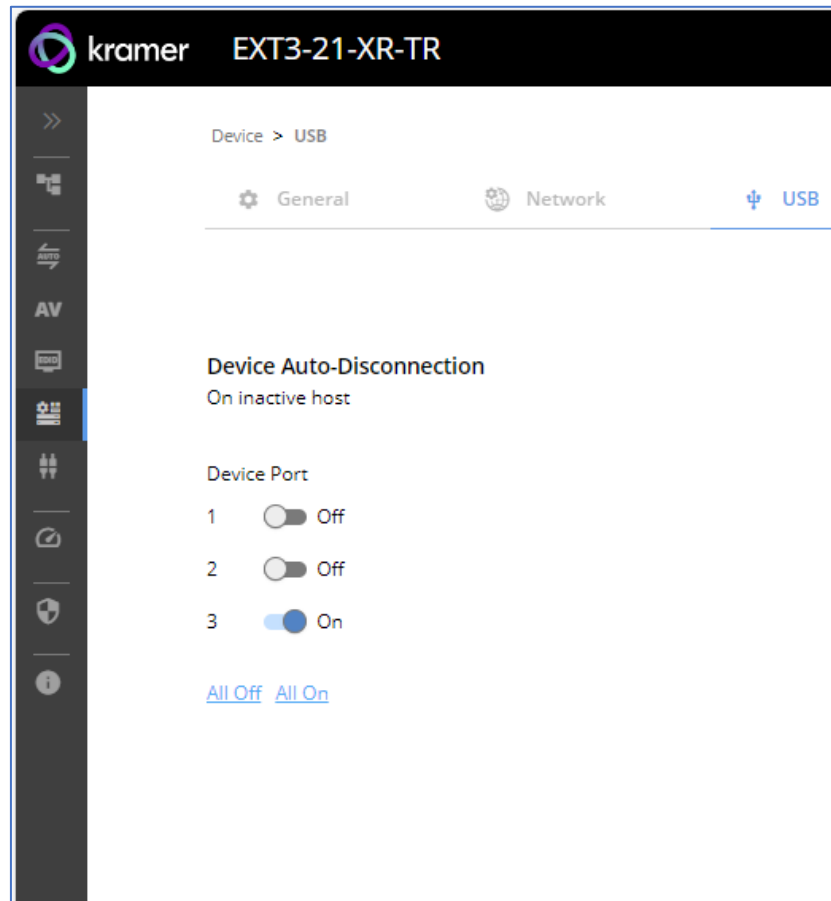

Figure 28: USB Page – USB Device Auto-Disconnection

3. For each USB Device Port, set the auto disconnection status to **On** or **Off**. You can also Select **All Off** or **All On** to set all device ports to off or on, respectively.
4. Click **SAVE**.

USB devices are set.

Setting Time and Date

You can sync the device time and date to any server around the world.

To sync device time and date to a server:

1. In the Navigation pane, click **Device**. The General tab in the Device page appears.
2. Select the **Time and Date** tab. The Time and Date tab appears.

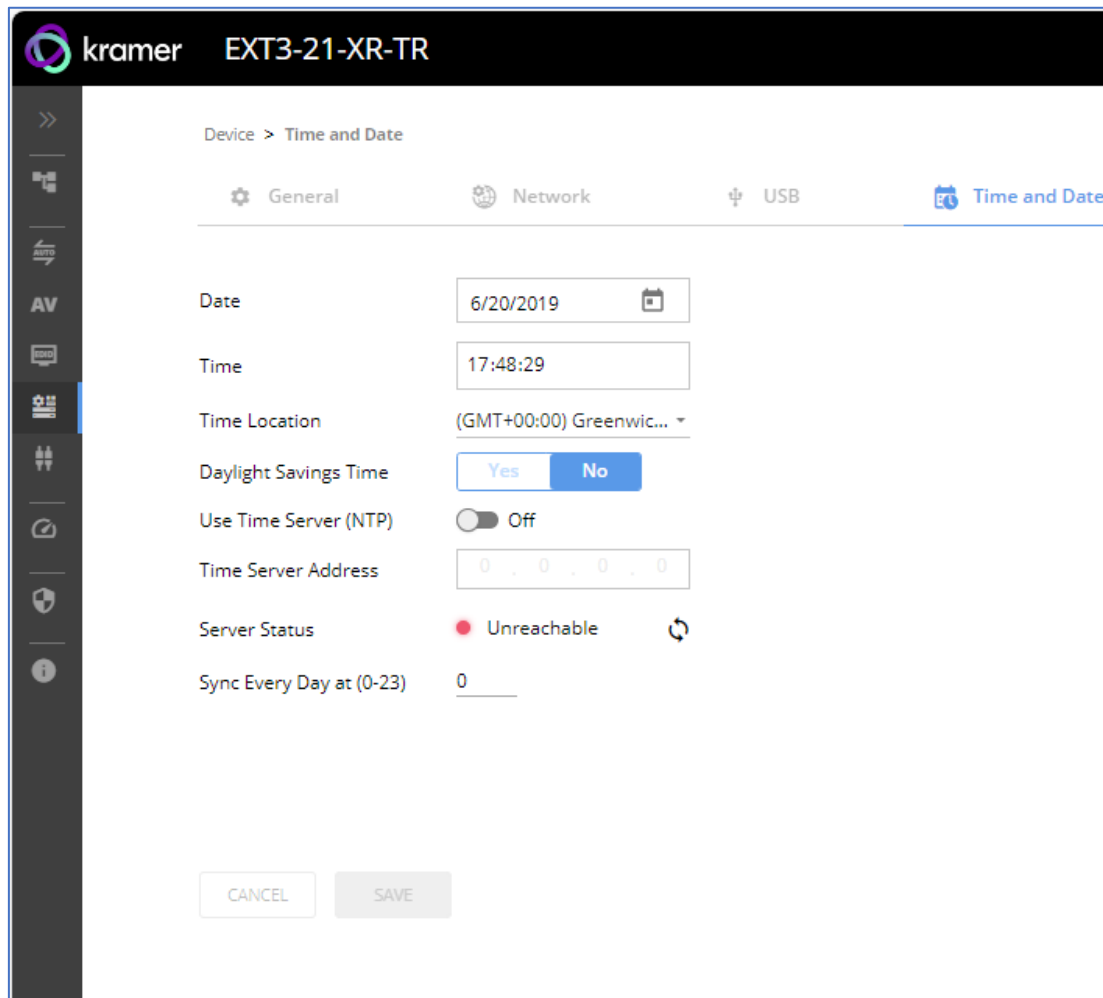

Figure 29: Device Settings – Time and Date Tab

3. Set the Date and Time.
4. Select the Time Location.
5. In the Use Time Server (NTP) drop-down box, click:
 - **Disabled** to disable the time server.
 - **Manual** to enable time server (NTP).
6. If enabled, type in server information:
 - Enter the time server address.
 - Set sync frequency (every 0 to 23 days).
7. Click **SAVE** for any change.

The devices date and time are synchronized to the server address entered.

Setting Control Gateway Properties

This section details the following actions:

- [Setting Serial Port Properties](#) on page [39](#).
- [Configuring I/O \(GPIO\) Ports](#) on page [44](#).
- [Defining and Testing Commands via Action Editor](#) on page [48](#).
- [Configuring Remote Buttons](#) on page [49](#).
- [Setting Relays](#) on page [49](#).
- [Associating Commands to DISPLAY ON/OFF \(Custom control\)](#) on page [50](#).
- [Setting IR Port Properties](#) on page [52](#).

Setting Serial Port Properties

EXT3-21-XR-TR has two RS-232 ports:

- Serial Port 1 – Panel RS-232 port
- Serial Port 2 – HDBT RS-232 channel

The serial ports are serving for one of the following:

- RS-232 extension – From panel port, via HDBT RS-232 channel, to control a peripheral connected to the HDBT paired unit RS-232 port.
- External peripheral IP control – Remote IP control of port-connected peripheral, via extender built-in control gateway.
- Extender management and control – Device service and control using P3000 commands (serial port 1 only)

EXT3-21-XR-TR enables configuring the RS-232 port in one of the following ways:

- [Extending the RS-232 via the EXT3-21-XR-TR](#) on page [39](#).
- [Controlling an External Device](#) on page [42](#).
- [Controlling the Display](#) on page [43](#).

Extending the RS-232 via the EXT3-21-XR-TR

Setting the HDBT Extension Mode:

Set the HDBT as an RS-232 extender to control the remote peripheral device.

To set the HDBT extension mode:

1. Go to the Control Gateway page. The Serial Ports tab appears.

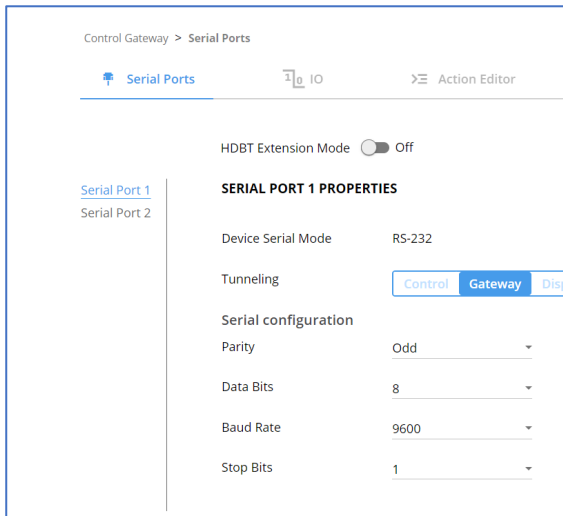

Figure 30: RS-232 Device Control

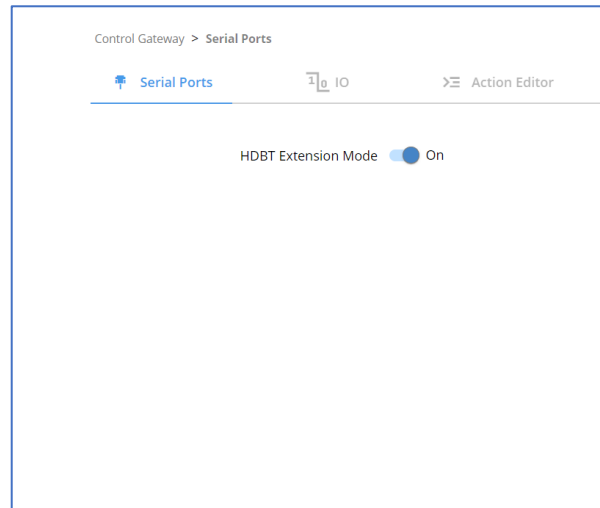

Figure 31: HDBT Extension Mode

2. Enable **HDBT Extension Mode** to ON (OFF is default mode).
 - **EXT3-21-XR-TR** is set to operate as an RS-232 extender, with end-to-end extension between RS-232 panel port and HDBT RS-232 channel.



In extension mode, no configuration of port properties and functions are available ([Figure 31](#)).

Controlling the EXT3-21-XR-TR

To set the RS-232 port to control the device:

1. Go to the Control Gateway page. The Serial Ports tab appears.

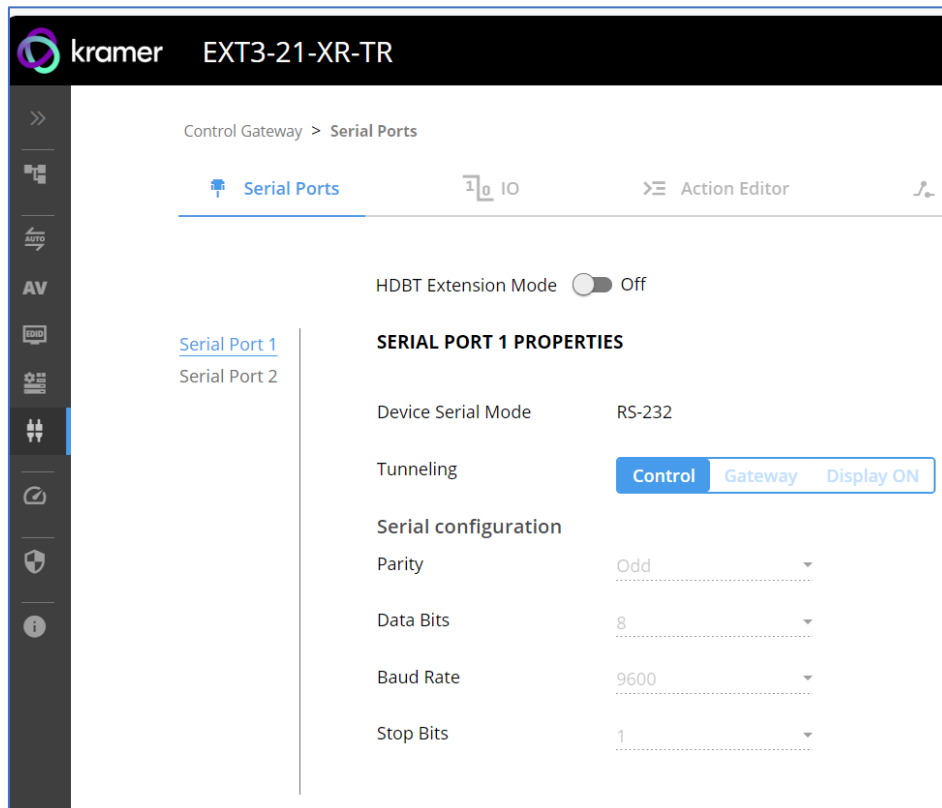

Figure 32: RS-232 Device Control

2. Select Serial Port 1
3. Next to Tunneling, select **Control**.
4. Click **SAVE**.

RS-232 port controls the **EXT3-21-XR-TR**.

Controlling an External Device via IP Messages

Control an external device via an IP-connected Controller (for example **SL-240C** that is connected via LAN)

To set the RS-232 port to control an external device:

1. Go to the Control Gateway page. The Serial Ports tab appears.
2. Next to Tunneling, select **Gateway**.

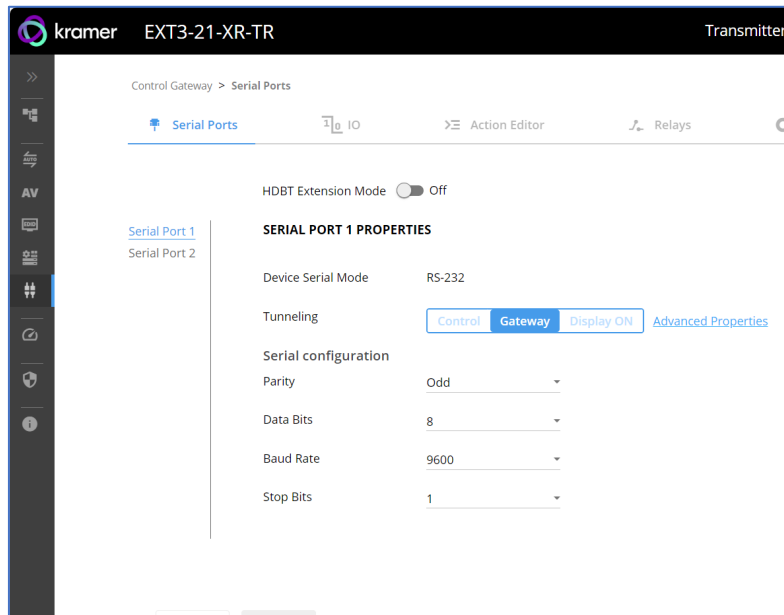

Figure 33: RS-232 as Gateway

3. Define the external device RS-232 settings (Parity, Data Bits, Baud Rate and Stop Bits).
4. Click Save.

The TUNNELING ADVANCED PROPERTIES settings tab appears.

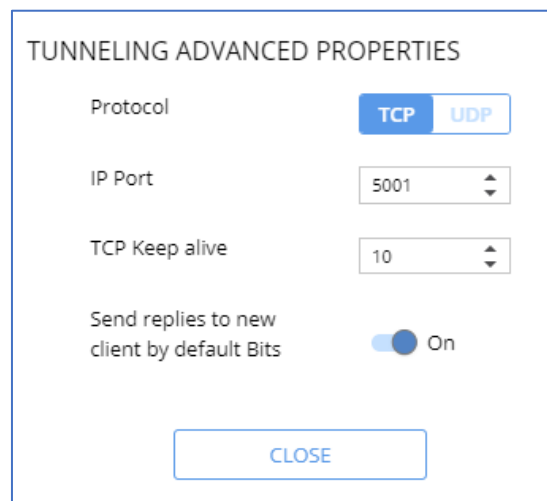

Figure 34: Setting Advanced Tunneling Properties

5. Select either TCP or UDP port.
6. Click up/down arrows to select IP Port.
7. Click up/down arrows to select desired seconds for TCP Keep alive.

8. Press to toggle ON Send replies to new clients by default Bits.
9. Click **CLOSE**.
10. Click **SAVE**.

RS-232 port controls an external device.

Controlling the Display

The following is another way to configure the DISPLAY ON button.(see [Associating Commands to DISPLAY ON/OFF \(Custom control\)](#) on page 50).

To set the RS-232 port to control an external device:

1. Go to the Control Gateway page. The Serial Ports tab appears.
2. Next to Tunneling, select **Display ON**.

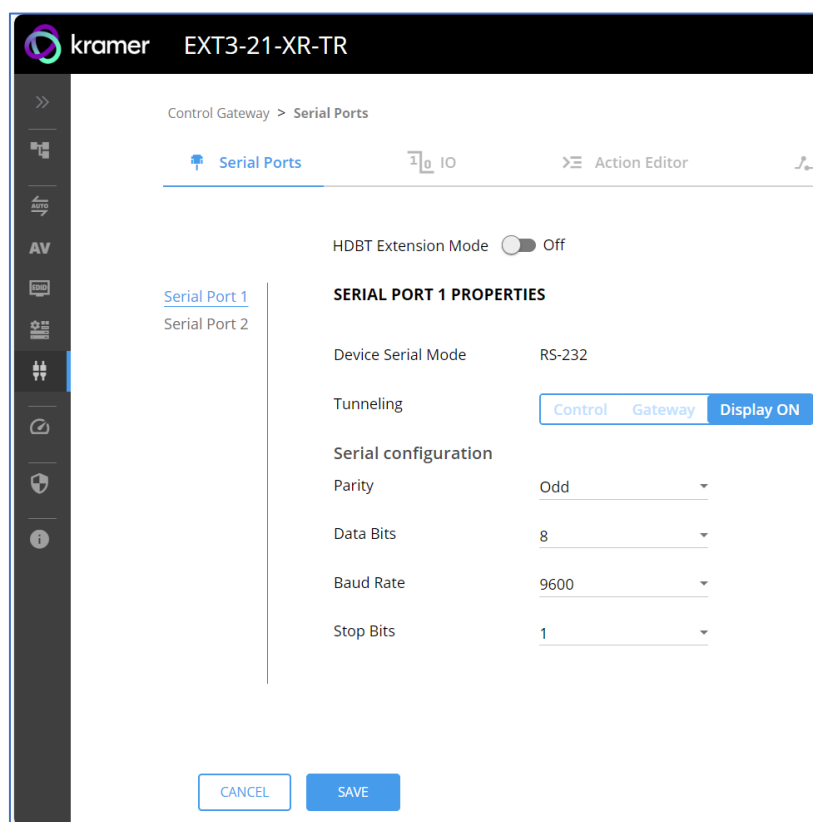

Figure 35: RS-232 Control for Display on/off

3. Define the display RS-232 settings (Parity, Data Bits, Baud Rate and Stop Bits).
4. Click **SAVE**.



In addition, configure specific display commands via Action Editor (see [Defining and Testing Commands via Action Editor](#) on page 48) and associate DISPLAY ON/OFF (Custom Control) commands via (see [Associating Commands to DISPLAY ON/OFF \(Custom control\)](#) on page 50).

RS-232 port controls the display on/off.

Configuring I/O (GPIO) Ports

The 2 I/O ports can control devices such as sensors, door locks, remote contact-closure buttons, audio volume and lighting control devices and can be configured via the webpages.

 To enable I/O operations, Remote Button must be set to Off.

To configure an I/O port:

1. In the Navigation pane, click **Control Gateway**. The Serial Ports tab in the Device Settings page appears.
2. Select the IO tab. The IO tab appears.

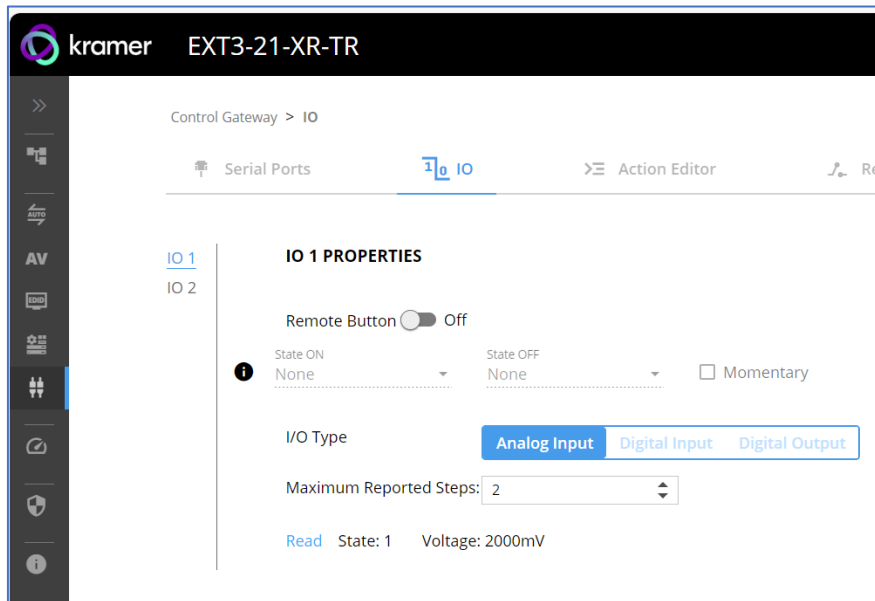



Figure 36: I/O Ports Settings Page

3. Select the I/O port to be configured (IO 1 or IO 2).
4. Select one of the following I/O types:
 - **Digital Input (default setting)** (see [Configuring a Digital Input I/O Type](#) on page 44).
 - **Digital Output** (see [Configuring a Digital Output I/O Type](#) on page 45).
 - **Analog Input** (see [Configuring an Analog Input I/O Type](#) on page 47).

 The settings available on the page change depending on which trigger type is selected.

5. Click **SAVE** after setting the selected I/O type.

Configuring a Digital Input I/O Type

The Digital Input trigger mode reads the digital input of an external sensor device that is connected to the I/O port. It detects High (upon passing Max threshold from Low state) or Low (upon passing Min threshold from High state) port states according to the user defined voltage threshold levels.

To configure a digital input I/O type:

1. On the IO page, select **Digital Input** next to I/O Type.
The Digital Input options appear ([Figure 36](#)).
2. Select one of the following for the Pull-up resistor setting:
 - **Disabled**
Suitable, for example, for a high temperature alarm that exceeds the maximum voltage threshold. When the pull-up resistor is disabled, the port state is low and to be triggered it must be pulled high by the externally connected sensor.
 - **Enabled** – Detection of an open circuit as High, or a short to ground as Low.
This is suitable for example, for a pushbutton switch (connecting one terminal of the switch to ground, and the other to the input) or for an alarm closing a circuit that activates a series of actions. When the pull-up resistor is enabled, the port state is high, and to be triggered it must be pulled low by the externally connected sensor.
3. Set the Threshold VDC Low and High Range (threshold voltage at which the port changes state).
4. Click **Read** to refresh port status information.
5. Click **SAVE**.

Digital input I/O type is configured.

Configuring a Digital Output I/O Type

To configure a digital output I/O type:

1. On the GPIO page, select Digital Output next to I/O type.
A warning message appears.

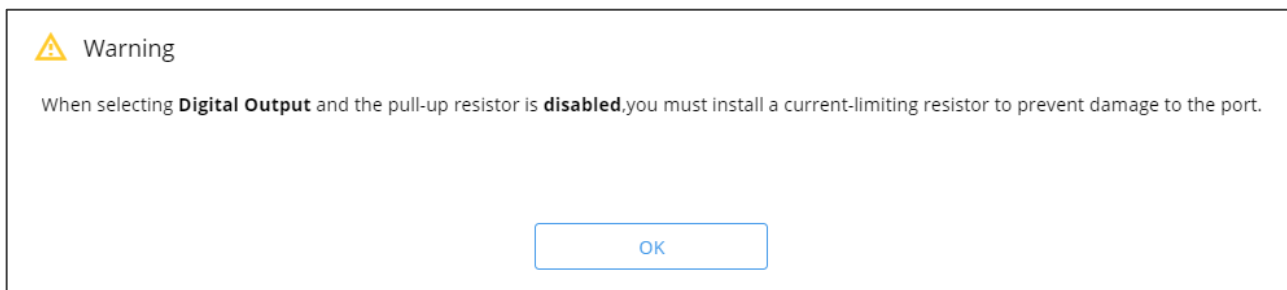

Figure 37: Digital Output Warning

2. Make sure to follow the instructions in this warning.

3. Click **OK**. The Digital Output options appear.

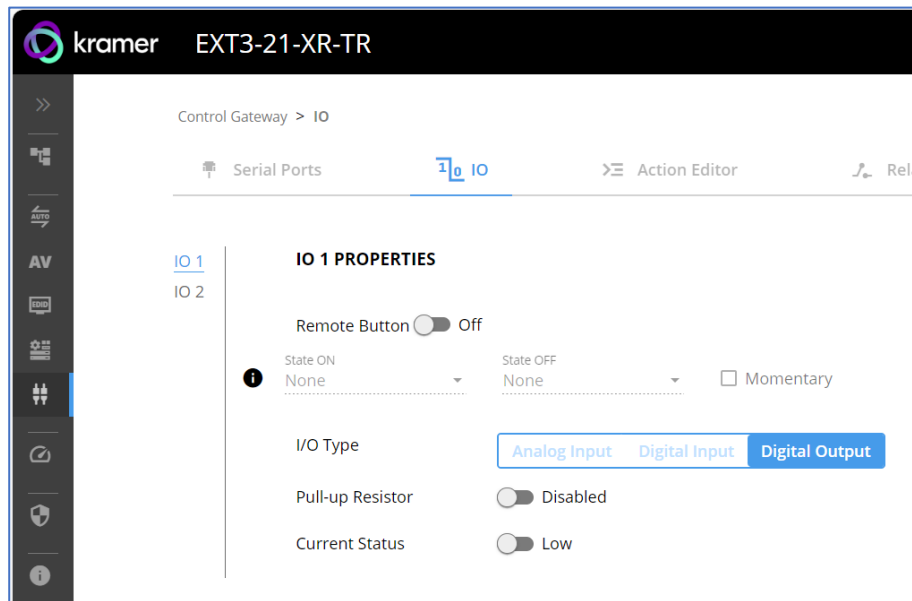



Figure 38: GPIO Settings Page – Digital Output I/O Type

4. Select one of the following for the Pull-up resistor setting:

- Pullup resistor set to **Enabled**:
The port can be used for controlling devices that accept a TTL signal such as for powering LEDs. The voltage output is TTL positive logic: high: >2.4V; low: < 0.5V. When the pull-up resistor is enabled, the port state is high. For the state to be low, you must select **Low** for the Current Status.
- Pullup resistor **Disabled**:
The port is used for controlling external devices such as room or light switches. The external source device determines the voltage output; the maximum voltage is 30V DC and the maximum current is 100mA. When the pull-up resistor is disabled, the port state is low. For the state to be high, select **High** for the Current Status.

 Make sure that the current in this configuration does not exceed 100mA.

5. Click **SAVE**.

Digital Output I/O type is configured.

Configuring an Analog Input I/O Type

When selecting the Analog Input I/O type, the port is controlled by an external analog device, such as a volume control device. The trigger is activated once when the detected voltage is within the 0 to 30V DC voltage range.

To configure an analog input I/O type:

1. On the GPIO page, select Analog Input next to I/O type.

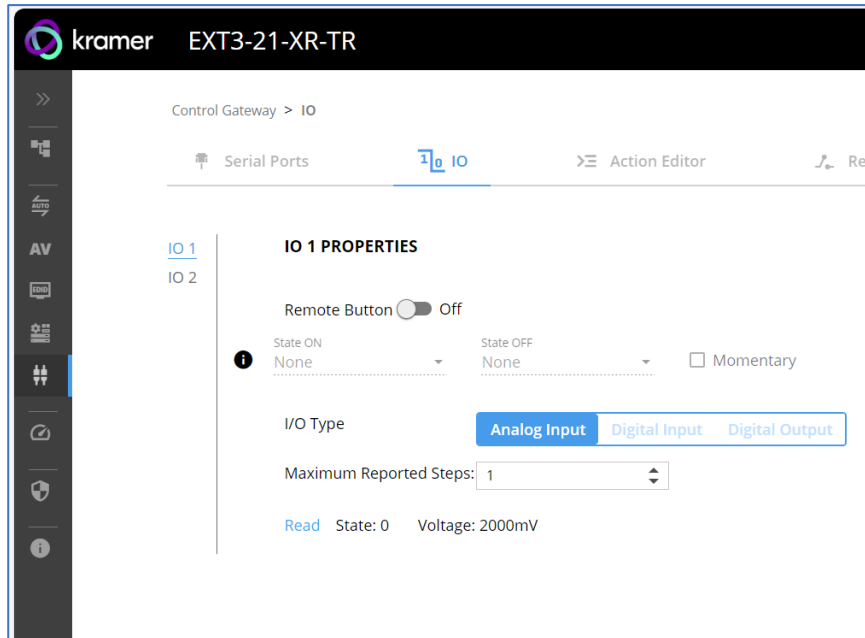

Figure 39: GPIO Port Settings Page Analog Input

2. Enter or use the arrows to scroll to a value (1–100) for the Maximum reported steps. This value is the number of steps that the analog input signal is divided into. To calculate the voltage of each step, use the following formula:

Voltage of one step = 30V / number of steps.

3. Click **SAVE**.

Analog input I/O type is configured.

Defining and Testing Commands via Action Editor

Use action editor to create and test control commands via CEC, UART, IR or RELAY control interfaces. You can create up to 5 commands.

To add an action:

1. In the navigation pane, select **Control Gateway**. The Serial Ports tab opens.
2. Select the **Action Editor** tab. The Action Editor appears.

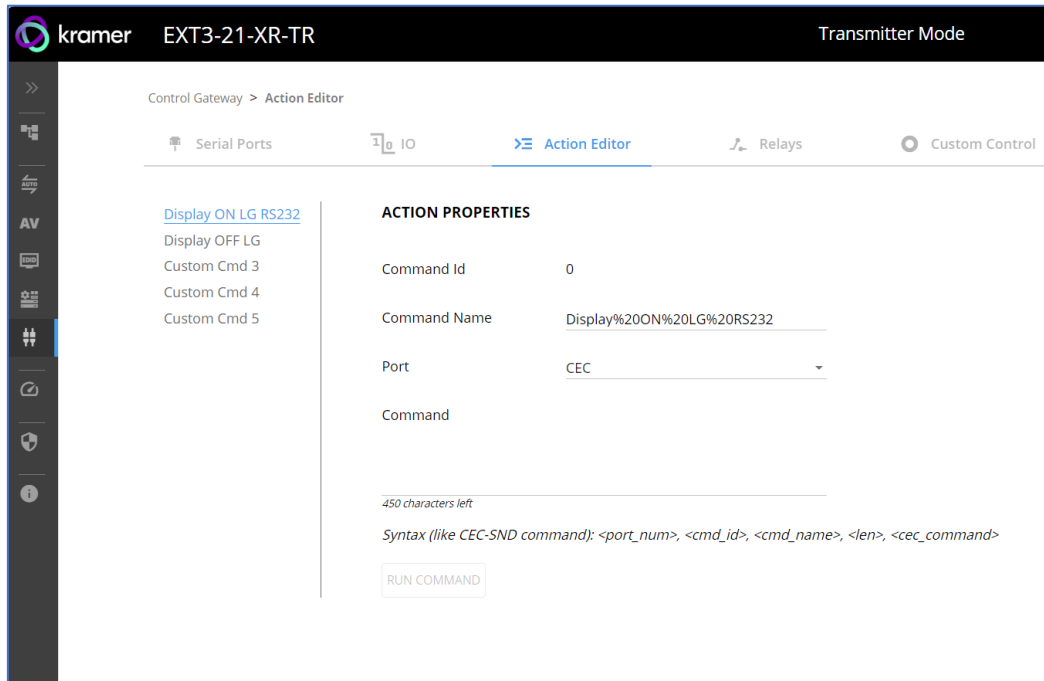

Figure 40: Action Editor Tab

3. Select a command name on the left side of the window.
4. Change the command name, if required.
5. Select the port (CEC, UART, RELAY or IR).
6. Enter the appropriate command line, such as one of the following Display On sample commands:

- For CEC – 1,1,tv-on,2,E004



The command to power on a TV can vary depending on the specific TV model and manufacturer. However, above is a common example of a standard command to power on a TV.

- For RS232 – PON

- For RELAY - <RelayNum>, <RelayState>

- For IR -

1,1,TVON,1,1,1,0000,006f,0022,0002,014d,00a6,0015,0015,0014,0015,0013,0014,0015,0015,0014,0014,0014,0014,0015,0015,0014,003e,0016,003d,0014,003f,0014,003e,0015,003f,0013,003f,0014,003e,0015,003f,0013,0016,0013,0015,0014,0015,0013,0016,0013,003f,0013,003e,0015,0015,0013,003e,0015,003f,0013,003f,0013,003e,0015,003e,0015,0015,0014,0015,0013,003f,0014,0015,0013,0014,0015,05c9,014d,0053,0015,0e0a

7. Click **SAVE**.
8. Click **RUN COMMAND** to run the command test.

An action is entered and can be run.

Configuring Remote Buttons

Remotely operate, by I/O-connected remote buttons, configured control actions (see (see [Defining and Testing Commands via Action Editor](#) on page 48).

To Configure Remote Buttons:

1. In the Navigation pane, click **Control Gateway**. The Serial Ports tab in the Device Settings page appears.
2. Select the IO tab. The IO tab appears.
3. Press to toggle **Remote Button** to On.
4. Configure defined control actions, for button on/off states, using the **State ON**, **State OFF** drop-down boxes.
 - Button default operation mode is latching. For momentary mode, check the Momentary checkbox.

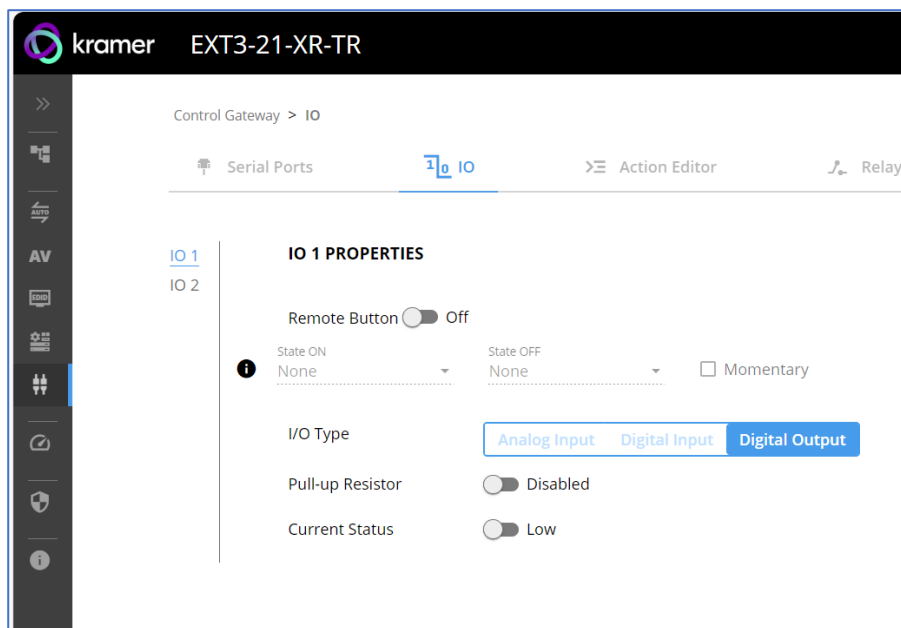

Figure 41: I/O ports settings tab – Configuring Remote Buttons

5. Click **SAVE**.

A control actions remote button can now be remotely operated.

Setting Relays

EXT3-21-XR-TR allows you to set the Relays, using the Relay tab to open or close a relay, configured as digital outputs on either controllers and auxiliary devices or control gateways.

To set a Relay action:

1. In the navigation pane, select **Control Gateway**.

2. Select the **Relays** tab. The Relays tab opens

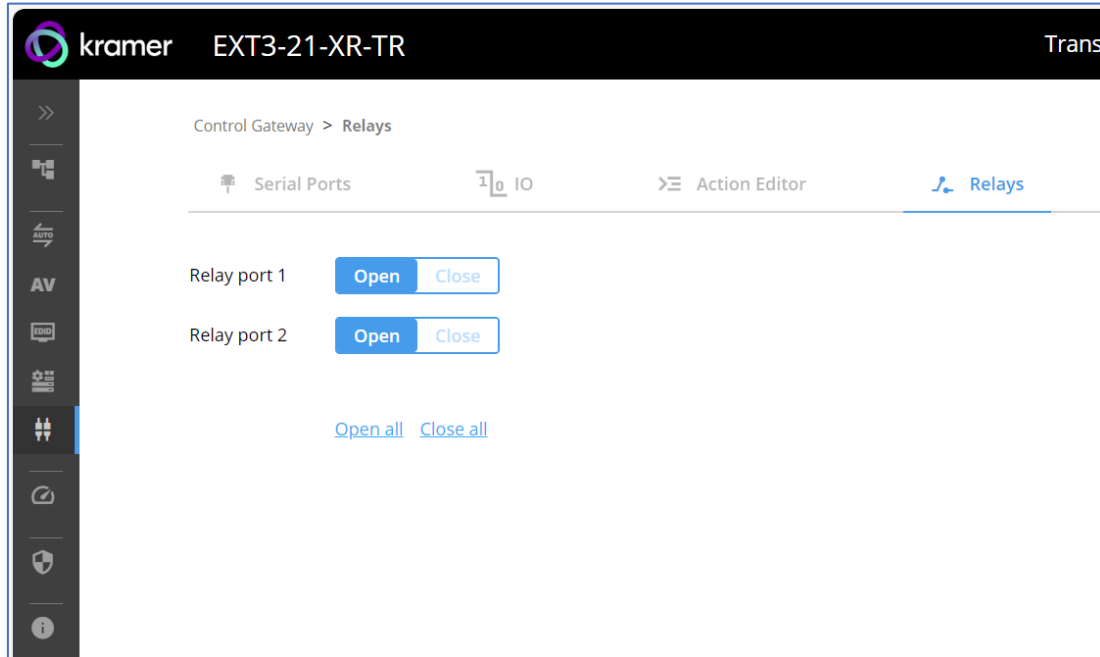

Figure 42: Relays Tab- Set the Relay Actions

3. Select:

- Relay port 1: Open (default) or Close
- Relay port 2: Open (default) or Close

4. Click **Save**.

The Relays are set.

Associating Commands to DISPLAY ON/OFF (Custom control)

Configure CEC, RS-232 or IR commands to send via DISPLAY ON (Custom Control) button.



The embedded webpages refer to DISPLAY ON as Custom Control. This will be updated in the next FW revision.



CEC Command(s) DISPLAY ON/OFF works as follows:

- For Tx: HDMI input CEC pass-thru over HDBT output.
- For Rx: HDMI/HDBT input CEC pass-thru to HDMI output.

To add an action:

1. In the navigation pane, select **Control Gateway**. The Serial Ports tab opens.

2. Select the **Display On** tab. The Display ON settings appears.

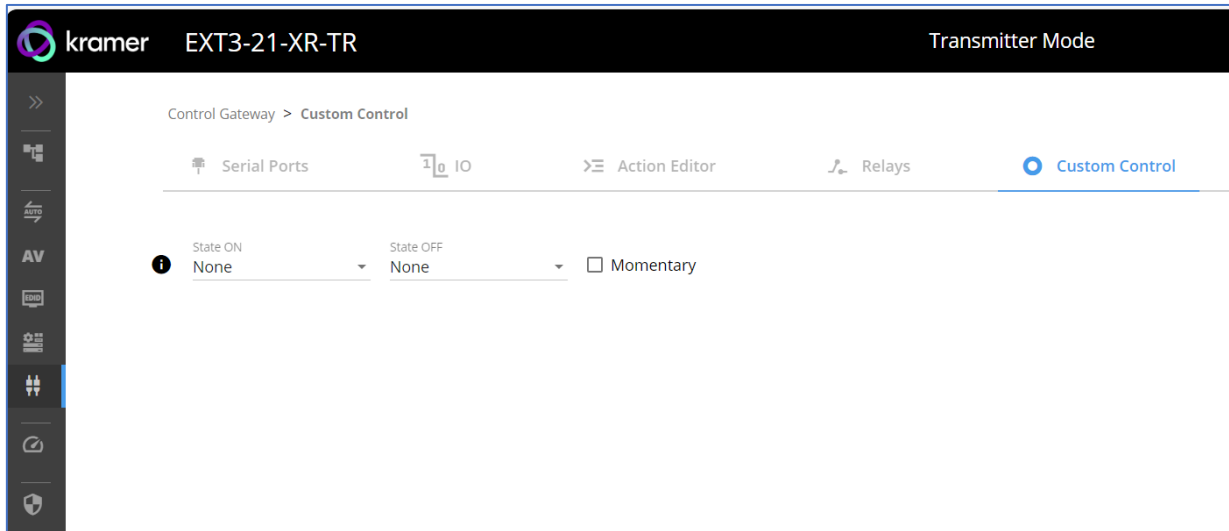

Figure 43: Display On/Off Settings Tab

3. Define the State On and State Off commands.
4. Check **Momentary** for the button to an ON command on the press of a button, and OFF on button release.
5. Click **SAVE**.

DISPLAY ON button is configured.

Setting IR Port Properties

EXT3-21-XR-TR has two IR ports:

- IR 1 – Panel IR port
- IR 2– HDBT IR channel

The IR ports are serving for one of the following:

- IR extension (HDBT IR) – From panel IR port or Internal Gateway, via HDBT IR channel, to control a peripheral connected to the HDBT paired device IR port. IR signals sending method is transparent pass-thru of received IR signal only.
- IR Local (Panel IR) – From HDBT extension or Internal Gateway to Local (Panel) IR port. IR signals sending methods are as follows:
 - Pass-thru – Transparent pass-through of received IR signal (default).
 - Modulation – IR signal extension with 38KHz modulated IR signal output.

IR routing cross-point grid for Tx and Rx operation modes (see [Figure 44](#)), enable IR signals routing, as follows:

Tx Selected IR Port	Rx Selected IR Port	IR Routing Description
IR 1 (Panel IR)	IR 2 (HDBT IR)	Received IR signal from panel IR port is extended, via HDBT IR channel, to output on remote HDBT-connected IR port
IR 2 (HDBT IR)	IR 1 (Panel IR)	Received IR-extended signal via HDBT IR channel is output on local IR panel port
GATEWAY 3	IR 1 (Panel IR)	IR control gateway outputs IR-generated signal to IR panel port (to IR-control locally-connected peripheral)
GATEWAY 3	IR 2 (HDBT IR)	IR control gateway outputs IR-generated signal to HDBT IR channel (to IR-control remotely-connected peripheral)



EXT3-21-XR-TR enables concurrent control gateway signals output on both, IR panel port and HDBT channel.

Routing IR Signals

1. In the navigation pane, select **Control Gateway**.
2. Select the **IR** tab. The IR tab opens (see [Figure 44](#)).
3. Select Tx and Rx IR routing cross-points by clicking on their IR icons. Selected IR routing indication appears.

4. If needed, select modulation method by pressing **M** on Rx IR 1 cell (see [\(Figure 45\)](#)).
5. Click **SAVE**.

 If using Internal Gateway, configure specific IR command via Action Editor Menu

IR signals routing is set.

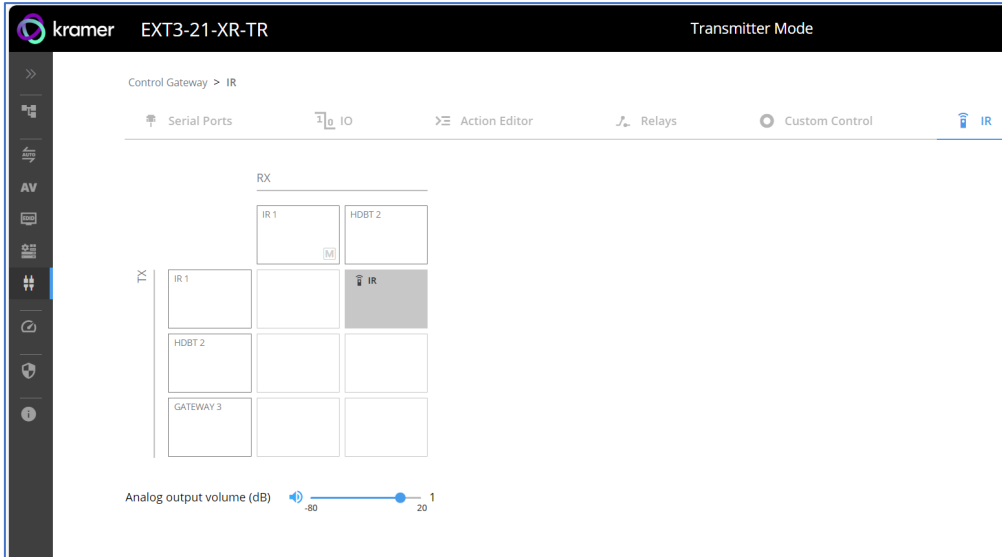

Figure 44: IR Tab Signals Routing

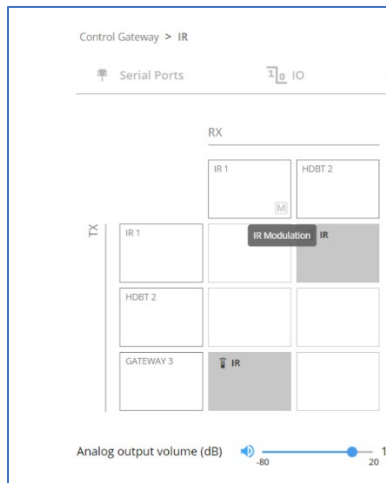

Figure 45: IR Modulation Method Setting

Setting Audio Output Volume Level

To set the audio output volume level, (see [Setting Analog Audio Output Volume Level](#) on page [27](#)).

Diagnostics

Viewing Device Status

View the device status.

To view the device status:

1. In the navigation pane, select **Status**.
2. Select the **Devices** tab. The Devices Status appears.

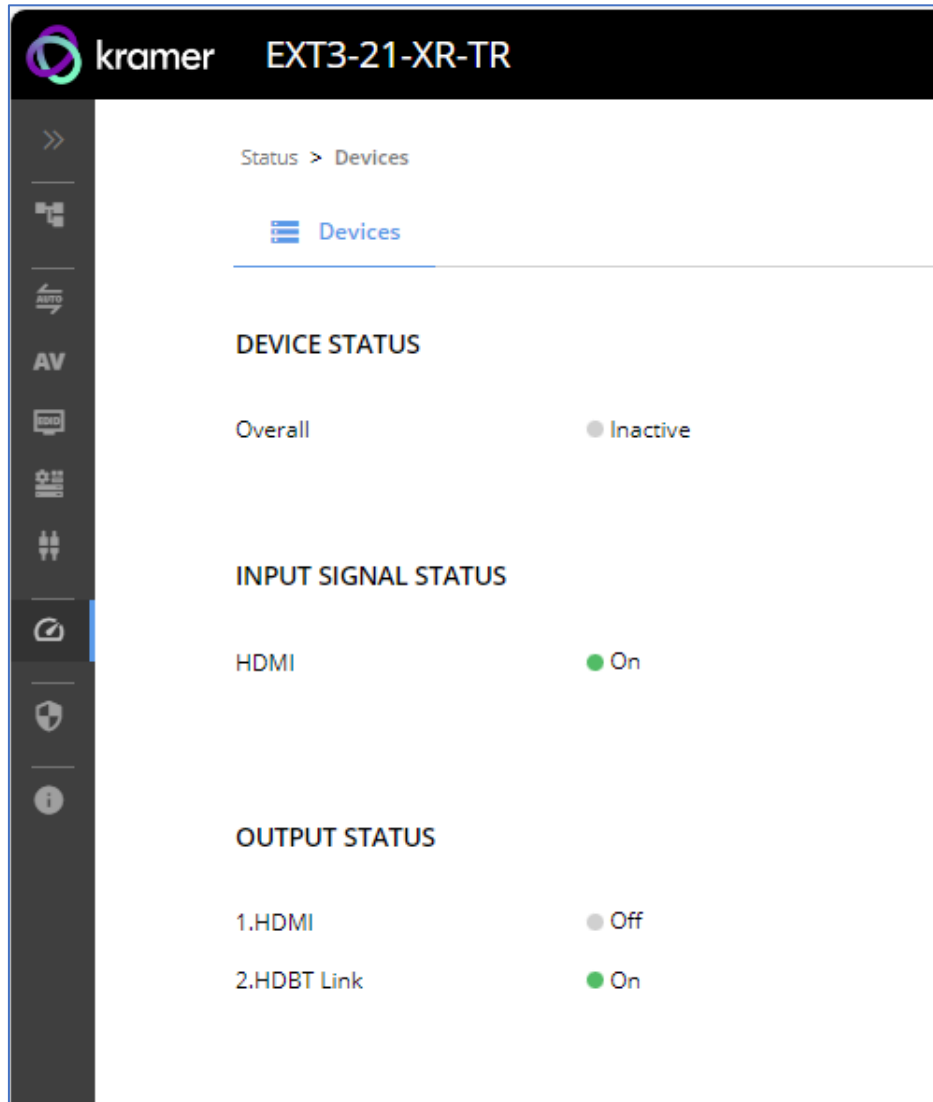

Figure 46: Device Status Page

3. View device status.

Device status can be viewed.

Administration

Setting Security Properties

This section details the following actions:

- [Changing Security Status](#) on page [55](#).
- [Defining 802.1X Authentication](#) on page [57](#).

Changing Security Status

By default, security status is set to On.

Setting Security Status to Off

To set security status to Off:

1. Go to the Security page ([Figure 47](#)).
2. Select the Security tab. The Security settings appear.

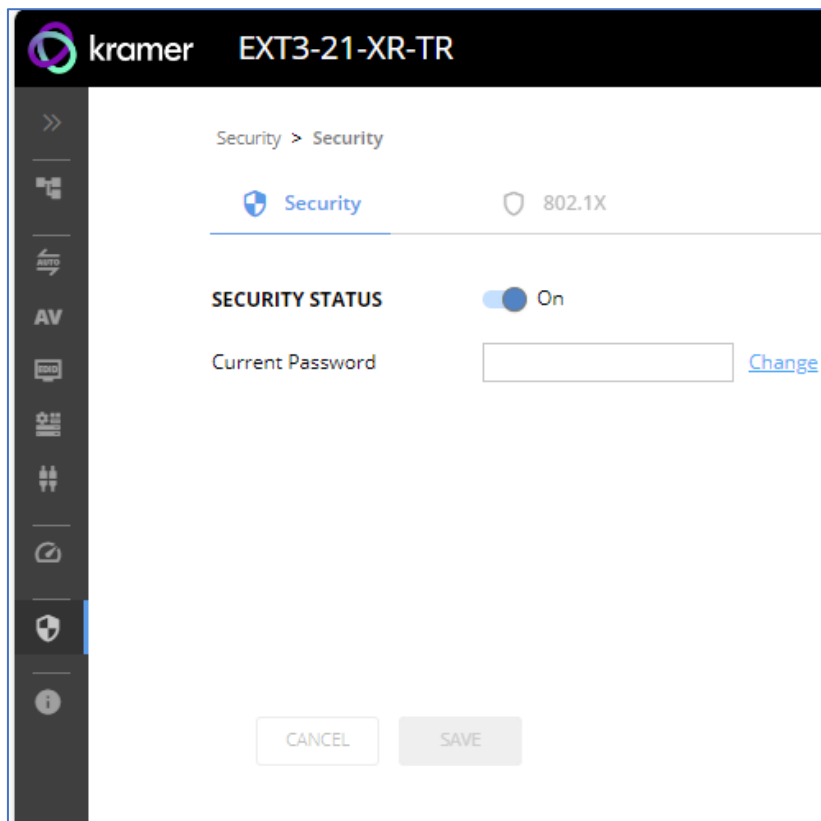
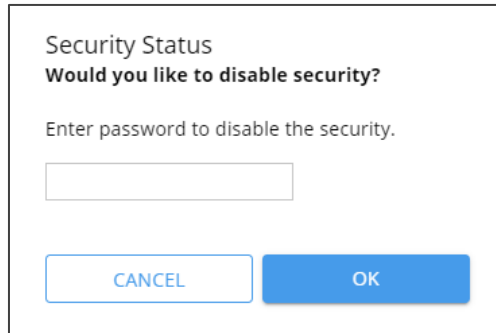

Figure 47: Security – Security Tab

- Set **SECURITY STATUS** to **Off**. The Security Status window appears.



Security Status
Would you like to disable security?

Enter password to disable the security.

Figure 48: Security Status Message

- Enter the current password.
- Click **OK**.

Security status is set to Off.

Setting Security Status to On

To set security status to on:

- Go to the Security > Security ([Figure 47](#)).
- Set SECURITY STATUS to **On**.

Security status is set to On.

Changing Web Pages Access Password

To change the password for accessing the embedded web pages:

- Go to the Security page ([Figure 47](#)).
- Select the Security Tab. The Security settings appear ([Figure 49](#)).
- Enter the Current Password and click **Change**. The new password settings appear.

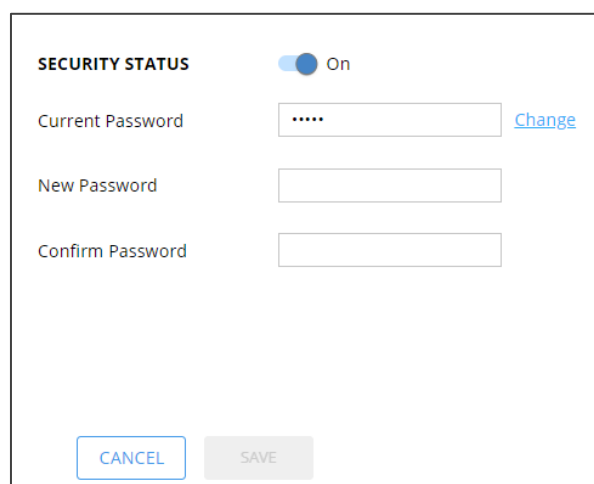

SECURITY STATUS On

Current Password [Change](#)

New Password

Confirm Password

Figure 49: Device Settings – Changing the Password

- Enter the new password and confirmation password and click **SAVE**.
The password is changed.

Defining 802.1X Authentication

802.1x security standard supports IT networking authentication based on LAN port and MAC address.

To configure security:

1. In the Navigation pane, click **Security**. The Security settings tab in the Security page appears.
2. Select **802.1X** tab. The 802.1X settings tab appears (see [Figure 50](#)).

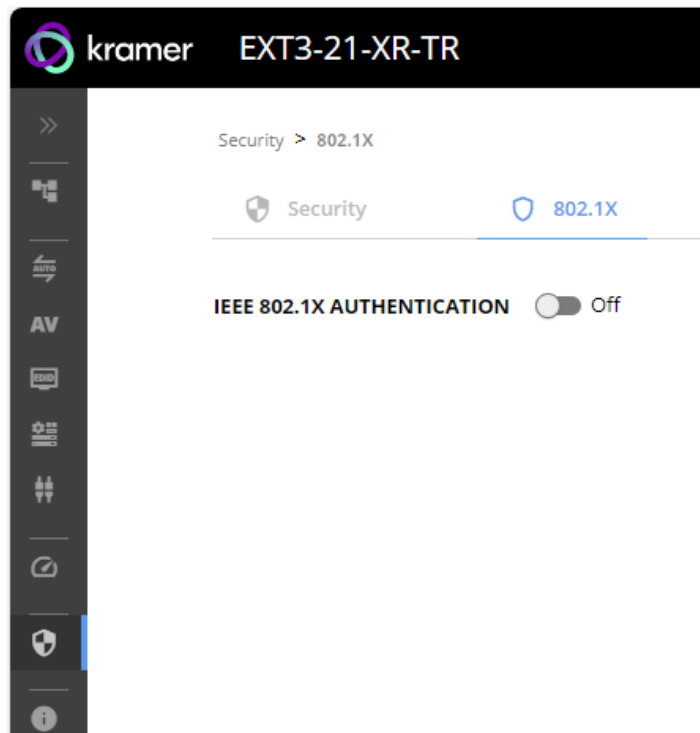

Figure 50: 802.1X Tab

3. For 802.1x authentication, click **ON** to enable 802.1x authentication service. 802.1x supports authentication based on port and MAC address.

4. When set to ON check one standard authentication method to set its security attributes.

- **PEAP-MSCHAP V2** (Figure 51) – Enter:
 - Username - up to 24 alphanumeric characters, including “_” and “-“ characters within the username, and
 - Password - up to 24 ASCII characters

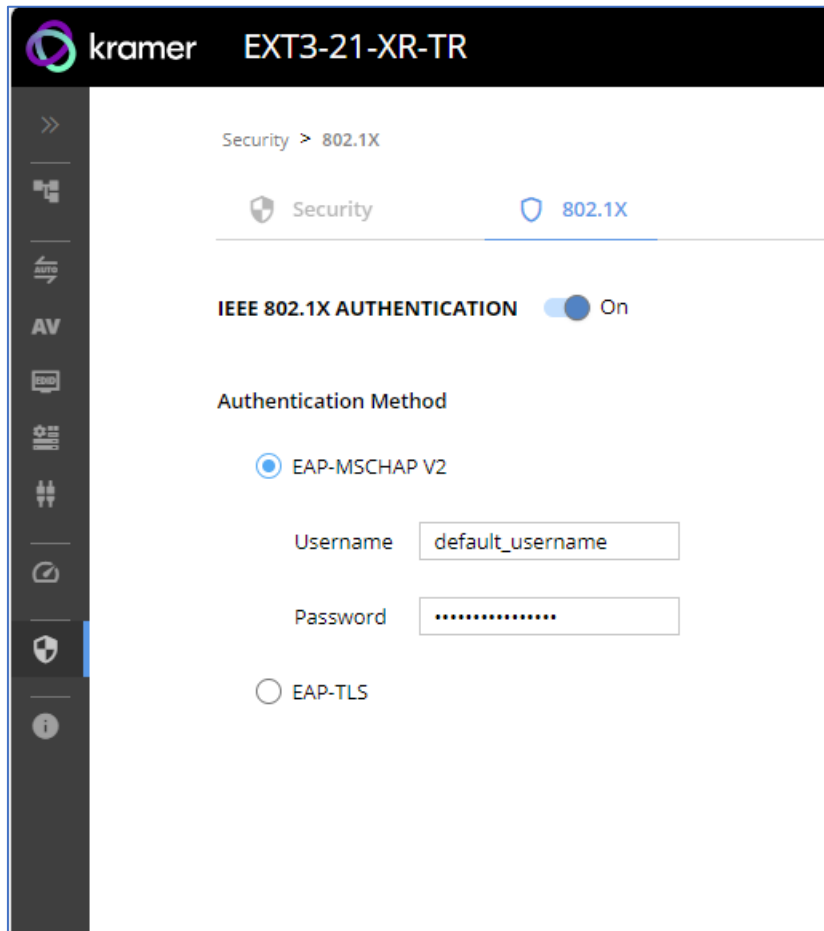



Figure 52: Security Tab – EAP-MSCHAP V2 Authentication

- **EAP-TLS** (Figure 53) – To submit certificate from the server for authentication:
 - Enter Username,
 - Click  to upload the certificates and keys,
 - Enter the private key password (assigned by IT administrator),
 - Set Server Certificate **On**

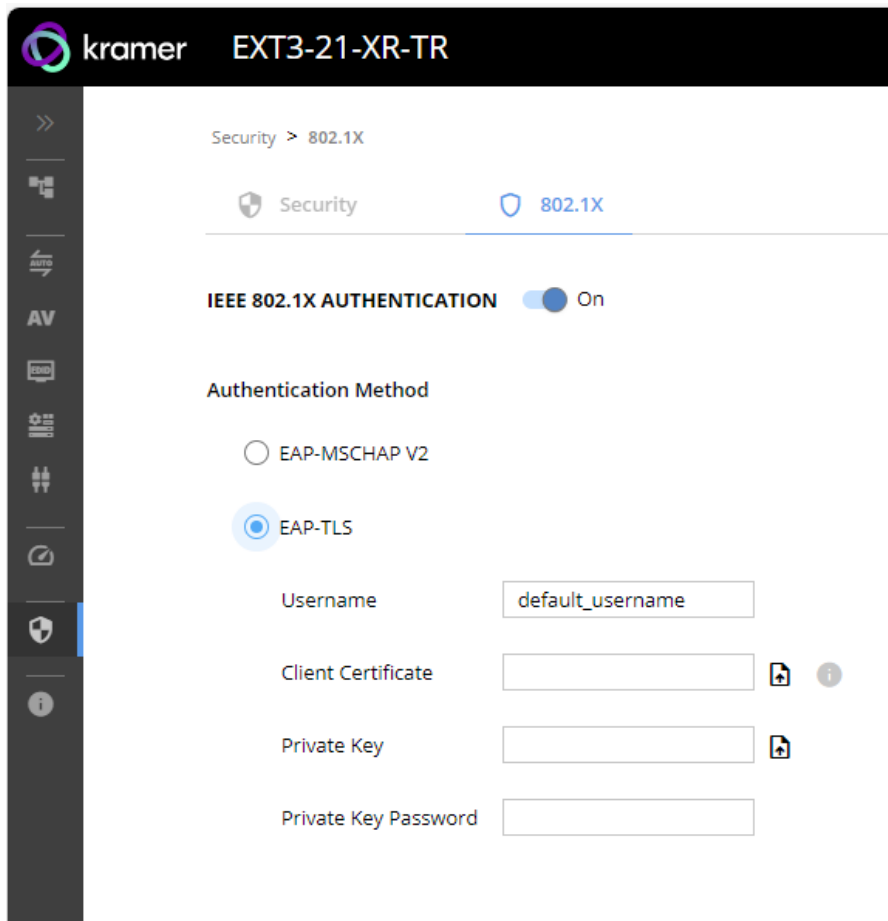

Figure 54: EAP-TLS – Certificates and Password

5. Click **APPLY**.

802.1x authentication security is configured.

Viewing the About Page

View the firmware version and Kramer Electronics Ltd details in the About page.

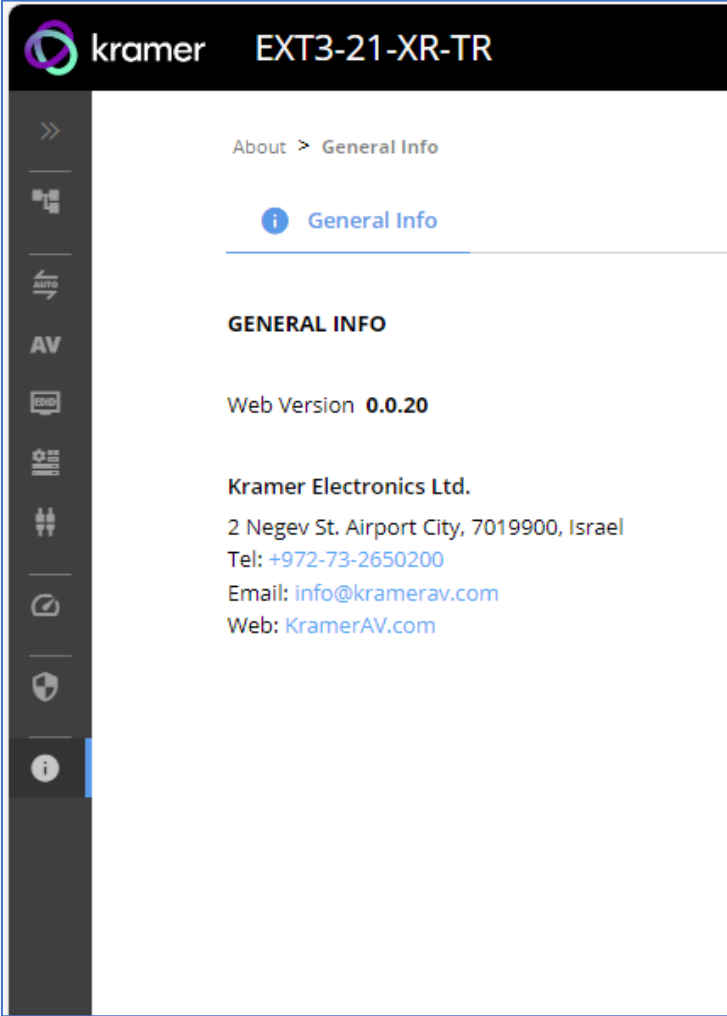

Figure 55: About Page

Upgrading Firmware

Use the Kramer **K-UPLOAD** software to upgrade the firmware via ethernet or the RS-232 port, allowing RS-232 to control/program the device). The device continues to operate and once FW upload complete, you are asked to Restart no or later.

The latest version of **K-UPLOAD** and installation instructions can be downloaded from our website at: www.kramerav.com/support/product_downloads.asp.



Note that in order to use the micro USB port, you need to install the Kramer USB driver, available at: www.kramerav.com/support/product_downloads.asp.

Technical Specifications

Inputs	1 HDMI	On an HDMI connector
	1 HDBT (Rx)	On an RJ-45 connector
Outputs	1 HDBT (Tx)	On an RJ-45 female connector
	1 HDMI Loop (Tx)	On an HDMI female connector
	1 HDMI (Rx)	On an HDMI female connector
	1 Balanced Stereo Audio Line (Tx or Rx)	On a 5-pin terminal block connector
Ports	1 USB 3.1 (Host)	On a USB-B female connector
	3 USB 3.1 (Device)	On USB type-A female connectors
	2 I/O	On a 2-pin terminal block
	1 1000BaseT Ethernet	On a 3-pin terminal block
	1 LAN PoE 1000BaseT Ethernet	On an RJ-45 female connector, for LAN connection
	1 RS-232	On a 3-pin terminal block connector
	1 IR	On a 3.5mm mini jack
	2 GPIO	On a 2-pin terminal block connector
	2 Relay	On a 4-pin terminal block connector
Extension Line	Reach	Up to 100m (330ft), using Kramer HDBaseT cables
	Standards Compliance	HDBaseT 3.0
Video	Max Data Rate	18Gbps bandwidth (6Gbps per graphic channel)
	Max Resolution	4K@60Hz (4:4:4) 24bpp resolution
	Content Protection	HDCP 2.3
	HDMI Support	4K, as specified in HDMI 2.0b
	Receiver-side Max Inputs Switching Time	HDMI to HDBT: 5sec HDBT to HDMI: 8 sec
USB Features	Integrated USB Hubs	1
	Standards Compliance	USB 3.2 GEN 2, 2.0 and 1.1
Extended USB	USB 2.0 Data Rate	Up to 480Mbps
	Transmitted Data Bandwidth	Up to 300Mbps
	Standards Compliance	USB 2.0 and 1.1
Extended Ethernet	Max Data Rate	1 Gbps
Extended RS-232	Baud Rate	300 to 115200
Analog Audio	Max Level	15dBu
	Impedance	500Ω
	Bandwidth	20Hz — 20kHz
	THD + N	0.002% @1kHz at nominal level
	S/N Ratio	-93dB, 20Hz — 20kHz
	Coupling:	DC
Controls	Front Panel	Rx INPUT SELECT buttons
		Display On buttons (Custom Control)
Indication LEDs	Front Panel	1 HDBT & HDMI LED
		1 ACTIVE HOST LED
		1 ACTIVE Rx LED
		1 PoE ► LED
		1 STATUS LED

		1 NET LED
Power	Power Adapter	Source: 48V 1.36A
		Consumption: 48V 0.73A
		Max. Power: 35W
	PoE	Consumption: 200mA
		Max. Power: 9.6W
	USB Device Charging	Max. Total Current: 2A
Environmental Conditions	Operating Temperature	0° to +40°C (32° to 104°F)
	Storage Temperature	-40° to +70°C (-40° to 158°F)
	Humidity	10% to 90%, RHL non-condensing
Regulatory Compliance	Safety	CE; FCC; UKCA
	Environmental	RoHs, WEEE
Enclosure	Size	Mega Tool
	Type	Aluminum
	Cooling	Convection Ventilation
General	Net Dimensions (W, D, H)	19 cm x 11.6 cm x 2.7 cm (7.48" x 4.56" x 1.06")
	Shipping Dimensions (W, D, H)	34.5 cm x 16.5 cm x 5.2 cm (13.58" x 6.5" x 0.41")
	Net Weight	0.60 kg (1.32 lbs)
	Shipping Weight	1.11 kg (2.44 lbs)
Accessories	Included	Power Adapter & cord & Bracket set & QS
Product Warranty Period	Contact Customer Support	
Specifications are subject to change without notice at www.kramerav.com		

Default Communication Parameters

RS-232	
Baud Rate:	115,200
Data Bits:	8
Stop Bits:	1
Parity:	None
Command Format:	ASCII
Example (Route video input 2 to the output):	#ROUTE_1,1,2<CR>
IP DHCP ON	
To reset the IP settings to the factory reset values go to: Menu->Setup -> Factory Reset-> press Enter to confirm	
Fallback IP Address:	192.168.1.39
Fallback Subnet mask:	255.255.255.0
Fallback gateway:	192.168.0.1
Default username:	Admin
Default password:	Admin
Full Factory Reset	
P3K	<p>"#FACTORY" command.</p> <p>After receiving "FACTORY OK" perform one of the following to restart the device and complete the procedure:</p> <ul style="list-style-type: none"> • Power cycle • Send command "#RESET"
Embedded webpages	Go to: Device>General and click FACTORY RESET

Protocol 3000

Kramer devices can be operated using Kramer Protocol 3000 commands sent via serial or Ethernet ports.

Understanding Protocol 3000

Protocol 3000 commands are a sequence of ASCII letters, structured according to the following.

- **Command format:**

Prefix	Command Name	Constant (Space)	Parameter(s)	Suffix
#	Command	_	Parameter	<CR>

- **Feedback format:**

Prefix	Device ID	Constant	Command Name	Parameter(s)	Suffix
~	nn	@	Command	Parameter	<CR><LF>

- **Command parameters** – Multiple parameters must be separated by a comma (,). In addition, multiple parameters can be grouped as a single parameter using brackets ([and]).
- **Command chain separator character** – Multiple commands can be chained in the same string. Each command is delimited by a pipe character (|).
- **Parameters attributes** – Parameters may contain multiple attributes. Attributes are indicated with pointy brackets (<...>) and must be separated by a period (.).

The command framing varies according to how you interface with **EXT3-21-XR-TR**. The following figure displays how the # command is framed using terminal communication software (such as Hercules):

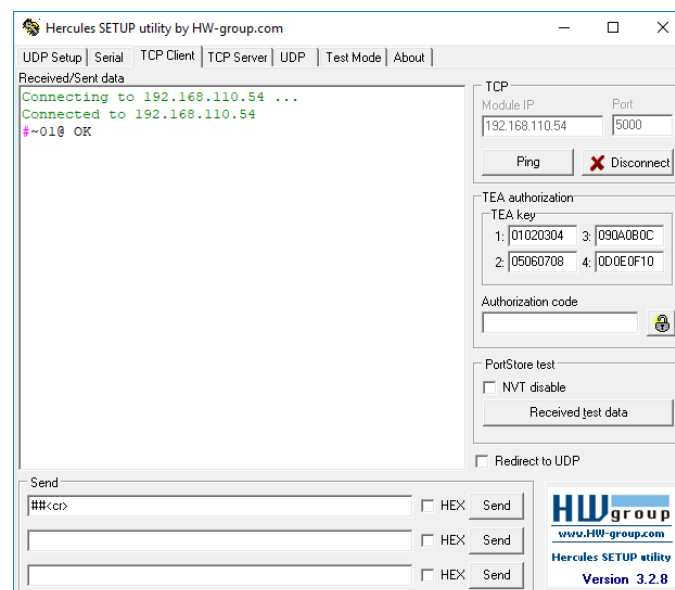





Protocol 3000 Commands



Function	Description	Syntax	Parameters/Attributes	Example
#	Protocol handshaking. ① Validates the Protocol 3000 connection and gets the machine number. Step-in master products use this command to identify the availability of a device.	COMMAND #<CR> FEEDBACK ~nn@_ok<CR><LF>		#<CR>
AUD-LVL	Set volume level.	COMMAND #AUD-LVL_<io_mode>,<io_index>,<vol_level><CR> FEEDBACK ~nn@AUD-LVL_<io_mode>,<io_index>,<vol_level><CR><LF>	io_mode – 1 – Output io_index – 1 vol_level – Volume level -100db to 15dB; ++ (increase current value by 1dB); -- (decrease current value by 1dB)	Set AUDIO OUT level to -50.0dB: #AUD-LVL_1,1,-50.0<CR>
AUD-LVL?	Get volume level.	COMMAND #AUD-LVL?_<io_mode>,<io_index><CR> FEEDBACK ~nn@AUD-LVL_<io_mode>,<io_index>,<vol_level><CR><LF>	io_mode – 1 – Output io_index – 1 vol_level – Volume level -100db to 15dB;	Get AUDIO OUT level: #AUD-LVL?_1,1<CR>
AUD-LVL-RANGE?	Get volume level min and max range.	COMMAND #AUD-LVL-RANGE?_<io_mode>,<io_index><CR> FEEDBACK ~nn@AUD-LVL-RANGE_<io_mode>,<io_index>,<min_val>,<max_val><CR><LF>	io_mode – 1 – Output io_index – 1 min_val – -100db max_val – 15dB	Get AUDIO OUT level range: #AUD-LVL-RANGE?_1,1<CR>
AUD-MUTE	Set audio mute.	COMMAND #AUD-MUTE_<out_index>,<mute_mode><CR> FEEDBACK ~nn@AUD-MUTE_<out_index>,<mute_mode><CR><LF>	out_index – 1 mute_mode – On/Off 0 – Off 1 – On	Set Output 1 to mute: #AUD-MUTE_1,1<CR>
AUD-MUTE?	Set audio mute.	COMMAND #AUD-MUTE_<out_index><CR> FEEDBACK ~nn@AUD-MUTE_<out_index>,<mute_mode><CR><LF>	out_index – 1 mute_mode – On/Off 0 – Off 1 – On	Get Output 1 to mute: #AUD-MUTE_1,1<CR>
AUD-MUTE-PERSIST	Set the auto audio unmute status upon volume change.	COMMAND #AUD-MUTE-PERSIST_<unmute_status><CR> FEEDBACK ~nn@AUD-MUTE-PERSIST_<unmute_status><CR><LF>	unmute_status – 0 – Mute state is not persistent and changes upon volume change 1 – Mute state is persistent upon volume change	Set mute mode to be persistent and not change upon volume change: #AUD-MUTE-PERSIST_1<CR>
AUD-MUTE-PERSIST?	Get the auto audio unmute status.	COMMAND #AUD-MUTE-PERSIST?_<unmute_status><CR> FEEDBACK ~nn@AUD-MUTE-PERSIST_<unmute_status><CR><LF>	unmute_status – 0 – Mute state is not persistent and changes upon volume change 1 – Mute state is persistent upon volume change	Get auto unmute status upon volume change: #AUD-MUTE-PERSIST?_<unmute_status><CR>
AUTH-802-1X-ENABLE	Set authentication 802.1X feature for the specific interface.	COMMAND #AUTH-802-1X-ENABLE_<interface>,<enable_status><CR> FEEDBACK ~nn@AUTH-802-1X-ENABLE_<interface>,<enable_status><CR><LF>	interface – Interface ID – 0 enable_status – 0 – Off 1 – On	Set the authentication 802.1X feature on: #AUTH-802-1X-ENABLE_0,1<CR>
AUTH-802-1X-ENABLE?	Get authentication 802.1X feature for the specific interface.	COMMAND #AUTH-802-1X-ENABLE?_<interface><CR> FEEDBACK ~nn@AUTH-802-1X-ENABLE_<interface>,<enable_status><CR><LF>	interface – Interface ID – 0 enable_status – 0 – Off 1 – On	Get the authentication 802.1X feature status: #AUTH-802-1X-ENABLE?_0<CR>
AV-SW-MODE	Set input auto switch mode (per output).	COMMAND #AV-SW-MODE_<layer_type>,<out_index>,<connection_mode><CR> FEEDBACK ~nn@AV-SW-MODE_<layer_type>,<out_index>,<connection_mode><CR><LF>	layer_type – Number that indicates the signal type: 1 – Video 2 – Audio out_index – 1 connection_mode – Connection mode 0 – manual 1 – priority switch 2 – last connected switch	Set the input audio switch mode to Manual for HDMI OUT: #AV-SW-MODE_1,1,0<CR>
AV-SW-MODE?	Get input auto switch mode (per output).	COMMAND #AV-SW-MODE?_<layer_type>,<out_index><CR> FEEDBACK ~nn@AV-SW-MODE_<layer_type>,<out_index>,<connection_mode><CR><LF>	layer_type – Number that indicates the signal type: 1 – Video 2 – Audio out_index – 1 connection_mode – Connection mode 0 – manual 1 – priority switch 2 – last connected switch	Get the input audio switch mode for HDMI OUT: #AV-SW-MODE?_1,1<CR>
BEACON-INFO?	Get beacon information, including IP address, UDP control port, TCP control port, MAC address, model, name.	COMMAND #BEACON-INFO?_<CR> FEEDBACK ~nn@BEACON-INFO_<port_id>,<ip_string>,<udp_port>,<tcp_port>,<mac_address>,<model>,<name><CR><LF>	port_id – ID of the Ethernet port ip_string – Dot-separated representation of the IP address udp_port – UDP control port tcp_port – TCP control port mac_address – Dash-separated mac address model – Device model name – Device name	Get beacon information: #BEACON-INFO?_<CR>

Function	Description	Syntax	Parameters/Attributes	Example
BUILD-DATE?	Get device build date.	COMMAND #BUILD-DATE?_<CR> FEEDBACK ~nn@BUILD-DATE_date,time<CR><LF>	date – Format: YYYY/MM/DD where YYYY = Year MM = Month DD = Day time – Format: hh:mm:ss where hh = hours mm = minutes ss = seconds	Get the device build date: #BUILD-DATE?<CR>
CEC-MEMBERS?	Get list of CEC logical addresses.	COMMAND #CEC-MEMBERS?_port_index<CR> FEEDBACK ~nn@CEC-MEMBERS_port_index,<la1>,<la2>...<CR><LF>	Port_index – 1 la – 1 to 15	Set gateway members: #CEC-MEMBERS?_1<CR>
CEC-NTFY-ACTIVE	Set CEC notification activity (valid until the next power up).	COMMAND #CEC-NTFY-ACTIVE_cec_ntf<CR> FEEDBACK ~nn@CEC-NTFY-ACTIVE_cec_ntf<CR><LF>	cec_ntf – 0 – Inactive 1 – Active	Enable CEC notification: #CEC-NTFY-ACTIVE_1<CR>
CEC-NTFY-ACTIVE?	Get CEC notification activity status.	COMMAND #CEC-NTFY-ACTIVE?_<CR> FEEDBACK ~nn@CEC-NTFY-ACTIVE_cec_ntf<CR><LF>	cec_ntf – 0 – Inactive 1 – Active	Get CEC notification activity status:: #CEC-NTFY-ACTIVE?_<CR>
CEC-SND	Send CEC command to port.	COMMAND #CEC-SND_port_index,sn_id,cmd_name,cec_len,cec_command<CR> FEEDBACK ~nn@CEC-SND_port_index,sn_id,cmd_name,cec_mode<CR><LF>	port_index – CEC port transmitting the command: 1 sn_id – 1 cmd_name – command name cec_len – 1-16 cec_command – CEC format command (in HEX format, no leading zeros, no '0x' prefix) cec_mode – CEC mode 0 – Sent 1 – Gateway disabled 2 – Inactive CEC-Master 3 – Busy 4 – Illegal Message Parameter 5 – Illegal CEC Address Parameter 6 – Illegal CEC Command 7 – Timeout 8 – Error	Send TV-OFF CEC command to the HDBaseT port: #CEC-SND_1,1,TV-OFF,2,e004<CR>
COM-ROUTE?	Get tunneling port routing.  This command sets tunneling port routing. Every com port can send or receive data from the ETH port. Set command can edit an existing configuration.	COMMAND #COM-ROUTE?_com_id<CR> FEEDBACK ~nn@COM-ROUTE_com_id,port_type,port_id,eth_rep_en,ping_val<CR><LF>	com_id – Machine dependent, * (get all route tunnels) port_type – TCP/UDP 0 – TCP 1 – UDP port_id – TCP/UDP port number eth_rep_en – Ethernet Reply 0 – COM port does not send replies to new clients 1 – COM port sends replies to new clients. ping_val – Send an empty string to TCP client every 0 to 3600 seconds. 0 - 3600	Get tunneling port routing for all route tunnels: #COM-ROUTE?_*<CR>
CONF-EXPORT	Export configuration file	COMMAND #CONF-EXPORT_<CR> FEEDBACK ~nn@CONF-EXPORT_filename<CR><LF>	file_name – the name of the file we want to upload for the export.	Export configuration file: #CONF-EXPORT_<CR>
CONF-IMPORT	Export configuration file	COMMAND #CONF-IMPORT_file_name<CR> FEEDBACK ~nn@CONF-IMPORT_file_name<CR><LF>	file_name – the name of the file we want to upload for the import.	Import configuration file: #CONF-IMPORT_EXT3-21-XR-TR-conf<CR>
COUNTER?	Get the sent or received CEC messages count.	COMMAND #COUNTER?_category_id,sub_category_id<CR> FEEDBACK ~nn@COUNTER_category_id,sub_category_id,count<CR><LF>	category_id – CEC messages: 0 Sub_category_id – Type of message: 0 – Sent message 1 – Received message count – Number range: 0-65535	Get the number of sent messages: #COUNTER?_0,0<CR>
COUNTER-CLR	Clear CEC messages.	COMMAND #COUNTER-CLR?_category_id,sub_category_clr<CR> FEEDBACK ~nn@COUNTER-CLR_category_id,sub_category_id,count<CR><LF>	category_id – CEC messages: 0 Sub_category_clr – Type of message to clear: 0 – Clear sent messages 1 – Clear received messages * – Clear all CEC messages	Clear all CEC messages: #COUNTER-CLR?_0,*<CR>

Function	Description	Syntax	Parameters/Attributes	Example
CPEDID	<p>Copy EDID data from the output to the input EEPROM.</p> <p>i Destination bitmap size depends on device properties (for 64 inputs it is a 64-bit word).</p> <p>Example: bitmap 0x0013 means inputs 1,2 and 5 are loaded with the new EDID.</p> <p>In certain products Safe_mode is an optional parameter. See the HELP command for its availability.</p>	<p>COMMAND</p> <pre>#CPEDID_<edid_io>,<src_id>,<edid_io>,<dest_bitmap><CR></pre> <p>or</p> <pre>#CPEDID_<edid_io>,<src_id>,<edid_io>,<dest_bitmap>,<safe_mode><CR></pre> <p>FEEDBACK</p> <pre>~nn@CPEDID_<edid_io>,<src_id>,<edid_io>,<dest_bitmap><CR><LF></pre> <pre>~nn@CPEDID_<edid_io>,<src_id>,<edid_io>,<dest_bitmap>,<safe_mode><CR><LF></pre>	<p>edid_io – EDID source type (usually output)</p> <ul style="list-style-type: none"> 0 – Input 1 – Output 2 – Default EDID 3 – Custom EDID <p>src_id – Number of chosen source stage</p> <ul style="list-style-type: none"> 0 – Default EDID source 1 – HDBaseT OUT or USB-C IN 2 – HDMI IN <p>edid_io – EDID destination type</p> <ul style="list-style-type: none"> 0 – Input <p>dest_bitmap – Bitmap representing destination IDs. Format: XXXX...X, where X is hex digit. The binary form of every hex digit represents corresponding destinations.</p> <ul style="list-style-type: none"> 0 – indicates that EDID data is not copied to this destination. 1 – indicates that EDID data is copied to this destination. <p>safe_mode – Safe mode (optional parameter)</p> <ul style="list-style-type: none"> 0 – device accepts the EDID as is without trying to adjust (default value if no parameter is sent) 1 – device tries to adjust the EDID 	<p>Copy the EDID data from the HDBaseT Output to the HDMI Input:</p> <pre>#CPEDID_1,1,0,0x1<CR></pre>
DEV-STATE?	Get the device state.	<p>COMMAND</p> <pre>#DEV-STATE?_<CR></pre> <p>FEEDBACK</p> <pre>~nn@DEV-STATE_<dev_state><CR><LF></pre>	<p>dev_state – device state</p> <ul style="list-style-type: none"> 0 – Active 1 – Power-on and no connected AV I/O ports (detecting cable connection faults) 2 – Power-on and standby (low power; cables are either connected or not) 	<p>Get device status:</p> <pre>#DEV-STATE?_<CR></pre>
DISPLAY?	Get output HPD status.	<p>COMMAND</p> <pre>#DISPLAY?_<out_index><CR></pre> <p>FEEDBACK</p> <pre>~nn@DISPLAY_<out_index>,<status><CR><LF></pre>	<p>out_index – Number that indicates the specific output:</p> <ul style="list-style-type: none"> 1 <p>status – HPD status according to signal validation</p> <ul style="list-style-type: none"> 0 – Signal or sink is not valid 1 – Signal or sink is valid 2 – Sink and EDID is valid 	<p>Get the output HPD status of Output 1:</p> <pre>#DISPLAY?_1<CR></pre>
EDID-AUDIO	Set audio capabilities for EDID.	<p>COMMAND</p> <pre>#EDID-AUDIO_<direction_type>.<port_format>.<port_index>.<signal_type>.<index>,<audio_format><CR></pre> <p>FEEDBACK</p> <pre>~nn@EDID-AUDIO_<direction_type>.<port_format>.<port_index>.<signal_type>.<index>,<audio_format><CR><LF></pre>	<p>The following attributes comprise the signal ID:</p> <ul style="list-style-type: none"> ▪ <direction_type> – Direction of the port: <ul style="list-style-type: none"> o IN – Input o OUT – Output ▪ <port_format> – Type of signal on the port: <ul style="list-style-type: none"> o HDMI o ANALOG_AUDIO o USB_C ▪ <port_index> – The port number as printed on the front or rear panel ▪ <signal_type> – Signal ID attribute: <ul style="list-style-type: none"> o AUDIO ▪ <index> – Indicates a specific channel number when there are multiple channels of the same type <p>audio_format – Audio block added to EDID:</p> <ul style="list-style-type: none"> 0 – Auto 1 – LPCM 2CH 2 – LPCM 6CH 3 – LPCM 8CH 4 – Bitstream 5 – HD 	<p>Set HDMI IN 2 audio capabilities for EDID (LPCM 6CH):</p> <pre>#EDID-AUDIO_in.hdmi.2.audio.1,2<CR></pre>

Function	Description	Syntax	Parameters/Attributes	Example
EDID-AUDIO?	Get audio capabilities for EDID.	COMMAND #EDID-AUDIO?_<direction_type>.<port_format>.<port_index>.<signal_type>.<index><CR> FEEDBACK ~nn@EDID-AUDIO_audio_format<CR><LF>	The following attributes comprise the signal ID: <ul style="list-style-type: none"> ▪ <direction_type> – Direction of the port: <ul style="list-style-type: none"> ○ IN – Input ○ OUT – Output ▪ <port_format> – Type of signal on the port: <ul style="list-style-type: none"> ○ HDMI ○ ANALOG_AUDIO ○ USB_C ▪ <port_index> – The port number as printed on the front or rear panel ▪ <signal_type> – Signal ID attribute: <ul style="list-style-type: none"> ○ AUDIO ▪ <index> – Indicates a specific channel number when there are multiple channels of the same type audio_format – Audio block added to EDID: 0 – Auto 1 – LPCM 2CH 2 – LPCM 6CH 3 – LPCM 8CH 4 – Bitstream 5 – HD	Get HDMI IN 2 audio capabilities for EDID: #EDID-AUDIO?_in.hDMI.2.audio.1,2<CR>

EDID-CD	 Setting command might change the current EDID.	COMMAND #EDID-CS_input_id,cs_mode<CR> FEEDBACK ~nn@EDID-CS_input_id,CS_mode<CR><LF>	Input_id – Indicates a specific input number to change EDID CS_color_mode – 0 – RGB only 1 – RGB + YUV444 2 – RGB + YUV422 3 – RGB + YUV444 + YUV422 4 – auto / original config	Set HDMI IN 3 EDID color space to force RGB (enabled): #EDID-CS_3,0<CR>
EDID-CS?	 Setting command might change the current EDID.	COMMAND #EDID-CS?_input_id<CR> FEEDBACK ~nn@EDID-CS_input_id <CR><LF>	Input_id – Indicates a specific input number to change EDID	Get EDID color space mode on input 2. #EDID-CS?_2<CR>
EDID-DC	Force removal of deep color on EDID or leaving it as in the original EDID.	COMMAND #EDID-DC_in_index,deep_color_state<CR> FEEDBACK ~nn@EDID-DC_in_index,deep_color_state<CR><LF>	in_index – Number that indicates the specific input: 1 – Input 1 2 – Input 2 deep_color_state – 0 – Don't change 1 – Remove deep color	Remove deep color on EDID for input 1. #EDID-DC_1,1<CR>
EDID-DC?	Get deep color status on EDID.	COMMAND #EDID-DC?_in_index <CR> FEEDBACK ~nn@EDID-DC_in_index,deep_color_state<CR><LF>	in_index – Number that indicates the specific input: 1 – Input 1 2 – Input 2 deep_color_state – 0 – Don't change 1 – Remove deep color	Get deep color state on EDID for input 2. #EDID-DC?_2<CR>
ETH-PORT	Set Ethernet port protocol.  If the port number you enter is already in use, an error is returned. The port number must be within the following range: 0-(2^16-1).	COMMAND #ETH-PORT_port_type,port_id<CR> FEEDBACK ~nn@ETH-PORT_port_type,port_id<CR><LF>	port_type – TCP/UDP port_id – TCP/UDP port number (0 – 65535)	Set the Ethernet port protocol for TCP to 12457: #ETH-PORT_TCP,12457<CR>
ETH-PORT?	Get Ethernet port protocol.  If the port number you enter is already in use, an error is returned. The port number must be within the following range: 0-(2^16-1).	COMMAND #ETH-PORT?_port_type<CR> FEEDBACK ~nn@ETH-PORT_port_type,port_id<CR><LF>	port_type – TCP/UDP port_id – TCP/UDP port number (0 – 65535)	Get the Ethernet port protocol for UDP: #ETH-PORT?_UDP<CR>

ETH-TUNNEL?	Get an open tunnel parameters.	COMMAND #ETH-TUNNEL?_tunnel_id<CR> FEEDBACK ~nn@ETH-TUNNEL_tunnel_id,cmd_name,port_type,port_id,eth_ip,remote_port_id,eth_rep_en,connection_type<CR><LF>	tunnel_id – Tunnel ID number, * (get all open tunnels) cmd_name – UART number port_type – TCP/UDP 0 – TCP 1 – UDP port_id – TCP/UDP port number eth_ip – Client IP address remote_port_id – Remote port number eth_rep_en – Ethernet Reply 0 – COM port does not send replies to new clients 1 – COM port sends replies to new clients connection_type – Connection type 0 – not wired connection 1 – wired connection	Set baud rate to 9600, 8 data bits, parity to none and stop bit to 1: #ETH-TUNNEL?_*<CR>
FACTORY	Reset device to factory default configuration.  This command deletes all user data from the device. The deletion can take some time. Your device may require powering off and powering on for the changes to take effect.	COMMAND #FACTORY<CR> FEEDBACK ~nn@FACTORY_ok<CR><LF>		Reset the device to factory default configuration: #FACTORY<CR>
FW-TYPE?	Get the current FW type status. Used by Kramer Network and KUpload to identify recovery process.	COMMAND #FW-TYPE?_<CR> FEEDBACK ~nn@FEATURE-LIST_fw_type<CR><LF>	Fw_type – 0 – Application 1 – Safe mode (kboot)	Get the current FW type status: #FW-TYPE?_<CR>
GPIO-CFG	Set HW GPIO configuration.	COMMAND #GPIO-CFG_gpio_id,gpio_type,gpio_dir,pullup<CR> FEEDBACK ~nn@GPIO-CFG_gpio_id,gpio_type,gpio_dir<CR><LF>	gpio_id – Hardware GPIO number (1-2) gpio_type – Hardware GPIO type 0 – analog 1 – digital gpio_dir – Hardware GPIO direction 0 – input 1 – output pullup – Enable/Disable pull-up 0 – disable 1 – enable	Set HW GPIO 1 configuration: #GPIO-CFG_1,1,1,1<CR>
GPIO-CFG?	Get HW GPIO configuration.	COMMAND #GPIO-CFG?_gpio_id<CR> FEEDBACK ~nn@GPIO-CFG_gpio_id,gpio_type,gpio_dir<CR><LF>	gpio_id – Hardware GPIO number (1-2) gpio_type – Hardware GPIO type 0 – analog 1 – digital gpio_dir – Hardware GPIO direction 0 – input 1 – output pullup – Enable/Disable pull-up 0 – disable 1 – enable	Get HW GPIO configuration: #GPIO-CFG?_1<CR>
GPIO-STATE	Set HW GPIO state.  GPIO-STATE? can only be set in digital out mode and the answer is 0=Low, 1=High. In all other modes an error message is sent. The device uses this command to notify the user of any change regarding the step and voltage in: In digital mode the answer is 0 (low), 1 (high). In analog mode the answer is 0 to 100.	COMMAND #GPIO-STATE_gpio_id,gpio_mode<CR> FEEDBACK ~nn@GPIO-STATE_gpio_id,gpio_mode<CR><LF>	gpio_id – Hardware GPIO number (1-2) gpio_mode – Hardware GPIO state 0 – Low 1 – High	Set GPIO 2 to High: #GPIO-STATE_2,1<CR>

GPIO-STATE?	<p>Get HW GPIO state.</p> <p>i GPIO-STATE? can only be set in digital out mode and the answer is 0=Low, 1=High. In all other modes an error message is sent.</p> <p>The device uses this command to notify the user of any change regarding the step and voltage in:</p> <p>In digital mode the answer is 0 (low), 1 (high).</p> <p>In analog mode the answer is 0 to 100.</p>	<p>COMMAND</p> <pre>#GPIO-STATE?_gpio_id<CR></pre> <p>FEEDBACK</p> <pre>~nn@GPIO-STATE_gpio_id,gpio_mode<CR><LF></pre>	<p>gpio_id – Hardware GPIO number (1-2)</p> <p>gpio_mode – Hardware GPIO state</p> <p>0 – Low</p> <p>1 – High</p>	<p>Get GPIO 2 state:</p> <pre>#GPIO-STATE?_2<CR></pre>
GPIO-STEP	<p>Set HW GPIO step.</p> <p>i In digital mode the response is 2.</p> <p>In analog mode the response is 1 to 100.</p> <p>In other modes an error is returned.</p>	<p>COMMAND</p> <pre>#GPIO-STEP_gpio_id,step_id<CR></pre> <p>FEEDBACK</p> <pre>~nn@GPIO-STEP_gpio_id,step_id,currentstep<CR><LF></pre>	<p>gpio_id – HW GPIO number (1-2)</p> <p>step_id – The configuration step – See note in description.</p> <p>currentstep – The actual step depending on the measured voltage</p>	<p>Set GPIO 2 (set to Analog In) configuration step to 38mV:</p> <pre>#GPIO-STEP_2,38<CR></pre>
GPIO-STEP?	<p>Get HW GPIO step.</p> <p>i In digital mode the response is 2.</p> <p>In analog mode the response is 1 to 100.</p> <p>In other modes an error is returned.</p>	<p>COMMAND</p> <pre>#GPIO-STEP?_gpio_id<CR></pre> <p>FEEDBACK</p> <pre>~nn@GPIO-STEP_gpio_id,step_id,currentstep<CR><LF></pre>	<p>gpio_id – HW GPIO number (1-2)</p> <p>step_id – The configuration step – See note in description.</p> <p>currentstep – The actual step depending on the measured voltage</p>	<p>Get GPIO 2 configuration:</p> <pre>#GPIO-STEP?_2<CR></pre>
GPIO-THR	<p>Set HW GPIO voltage levels.</p>	<p>COMMAND</p> <pre>#GPIO-THR_gpio_id,low_level,high_level<CR></pre> <p>FEEDBACK</p> <pre>~nn@GPIO-THR_gpio_id,low_level,high_level<CR><LF></pre>	<p>gpio_id – Hardware GPIO number (1-2)</p> <p>low_level – Voltage 500 to 28000 millivolts</p> <p>high_level – Voltage 2000 to 30000 millivolts</p>	<p>Set GPIO 2 to a low level of 800mV and a high level of 2200mV:</p> <pre>#GPIO-THR_2,800,2200<CR></pre>
GPIO-THR?	<p>Get HW GPIO voltage levels that were set.</p>	<p>COMMAND</p> <pre>#GPIO-THR?_gpio_id<CR></pre> <p>FEEDBACK</p> <pre>~nn@GPIO-THR_gpio_id,low_level,high_level<CR><LF></pre>	<p>gpio_id – Hardware GPIO number (1-2)</p> <p>low_level – Voltage 500 to 28000 millivolts</p> <p>high_level – Voltage 2000 to 30000 millivolts</p>	<p>Get GPIO 2:</p> <pre>#GPIO-THR?_2<CR></pre>
GPIO-VOLT?	<p>Get active voltage levels of HW GPIO.</p> <p>i This command is not available in digital out mode.</p>	<p>COMMAND</p> <pre>GPIO-VOLT?_gpio_id<CR></pre> <p>FEEDBACK</p> <pre>~nn@GPIO-VOLT_gpio_id,voltage<CR><LF></pre>	<p>gpio_id – Hardware GPIO number (1-2)</p> <p>voltage – Voltage 0 to 30000 millivolts</p>	<p>Get GPIO 1 voltage:</p> <pre>#GPIO-VOLT?_1<CR></pre>
HDCCP-MOD	<p>Set HDCCP mode.</p> <p>i Get HDCCP working mode on the device input:</p> <p>HDCCP supported – HDCCP ON [default].</p> <p>HDCCP not supported - HDCCP OFF.</p> <p>HDCCP support changes following detected sink - MIRROR OUTPUT.</p>	<p>COMMAND</p> <pre>#HDCCP-MOD_in_index,mode<CR></pre> <p>FEEDBACK</p> <pre>~nn@HDCCP-MOD_in_index,mode<CR><LF></pre>	<p>in_index – Number that indicates the specific input:</p> <p>1 – USB-C IN</p> <p>2 – HDMI IN</p> <p>mode – HDCCP mode:</p> <p>0 – HDCCP Off</p> <p>1 – HDCCP On</p> <p>2 – Follow Input</p> <p>3 – HDCCP defined according to the connected output</p>	<p>Set the input HDCCP-MODE of HDMI IN to off:</p> <pre>#HDCCP-MOD_2,0<CR></pre>
HDCCP-MOD?	<p>Get HDCCP mode.</p> <p>i Get HDCCP working mode on the device input:</p> <p>HDCCP supported – HDCCP ON [default].</p> <p>HDCCP not supported - HDCCP OFF.</p> <p>HDCCP support changes following detected sink - MIRROR OUTPUT.</p>	<p>COMMAND</p> <pre>#HDCCP-MOD?_in_index<CR></pre> <p>FEEDBACK</p> <pre>~nn@HDCCP-MOD_in_index,mode<CR><LF></pre>	<p>in_index – Number that indicates the specific input:</p> <p>1 – USB-C IN</p> <p>2 – HDMI IN</p> <p>mode – HDCCP mode:</p> <p>0 – HDCCP Off</p> <p>1 – HDCCP On</p> <p>2 – Follow Input</p> <p>3 – HDCCP defined according to the connected output</p>	<p>Get the input HDCCP-MODE of HDMI IN :</p> <pre>#HDCCP-MOD?_2<CR></pre>

HDCP-OUT	<p>Set HDCP mode.</p> <p>ⓘ Get HDCP working mode on the device input:</p> <p>HDCP supported – HDCP ON [default].</p> <p>HDCP not supported - HDCP OFF.</p> <p>HDCP support changes following detected sink - MIRROR OUTPUT.</p>	<p>COMMAND</p> <pre>#HDCP-OUT _out_index,mode<CR></pre> <p>FEEDBACK</p> <pre>~nn@HDCP-OUT _out_index,mode<CR><LF></pre>	<p>out_index – Number that indicates the specific input: 1 – HDBaset OUT</p> <p>mode – HDCP mode: 0 – Follow Input 1 – HDCP always ON (i.e. output signal is always HDCP-encrypted, regardless of input HDCP)</p>	<p>Set the output HDCP mode of HDBaseT OUT to follow input:</p> <pre>#HDCP-OUT _1,0<CR></pre>
HDCP-OUT?	<p>Get HDCP mode.</p> <p>ⓘ Get HDCP working mode on the device input:</p> <p>HDCP supported – HDCP ON [default].</p> <p>HDCP not supported - HDCP OFF.</p> <p>HDCP support changes following detected sink - MIRROR OUTPUT.</p>	<p>COMMAND</p> <pre>#HDCP-OUT? _out_index<CR></pre> <p>FEEDBACK</p> <pre>~nn@HDCP-OUT _out_index,mode<CR><LF></pre>	<p>out_index – Number that indicates the specific input: 1 – HDBaset OUT</p> <p>mode – HDCP mode: 0 – Follow Input 1 – HDCP always ON (i.e. output signal is always HDCP-encrypted, regardless of input HDCP)</p>	<p>Get the output HDCP-MODE of HDBaseT OUT :</p> <pre>#HDCP-OUT? _1<CR></pre>
HDCP-STAT?	<p>Get HDCP signal status of a connected device.</p> <p>ⓘ io_mode =1 – get the HDCP signal status of the sink device connected to the specified output.</p> <p>io_mode =0 – get the HDCP signal status of the source device connected to the specified input.</p>	<p>COMMAND</p> <pre>#HDCP-STAT? _io_mode,in_index<CR></pre> <p>FEEDBACK</p> <pre>~nn@HDCP-STAT _io_mode,in_index,status<CR><LF></pre>	<p>io_mode – Input/Output 0 – Input 1 – Output</p> <p>io_index – Number that indicates the specific number of inputs or outputs (based on io_mode): 1 – HDBaseT OUT or USB-C IN 2 – HDMI IN</p> <p>status – Signal encryption status - valid values On/Off: 0 – HDCP Off 1 – HDCP On</p>	<p>Get the HDCP status of the source device connected to USB-C IN:</p> <pre>#HDCP-STAT? _0,1<CR></pre>
HELP	<p>Get command list or help for specific command.</p>	<p>COMMAND</p> <pre>#HELP<CR></pre> <pre>#HELP _cmd_name<CR></pre> <p>FEEDBACK</p> <p>1. Multi-line:</p> <pre>~nn@Device _cmd_name, _cmd_name..<CR><LF></pre> <p>To get help for command use: HELP (COMMAND_NAME)<CR><LF></p> <pre>~nn@HELP _cmd_name:<CR><LF></pre> <pre>description<CR><LF></pre> <pre>USAGE: usage<CR><LF></pre>	<p>cmd_name – Name of a specific command</p>	<p>Get the command list:</p> <pre>#HELP<CR></pre> <p>To get help for AV-SW-TIMEOUT: HELP _av-sw-timeout<CR></p>
IDV	<p>Set visual indication from device.</p> <p>ⓘ Using this command, some devices can light a sequence of buttons or LEDs to allow identification of a specific device from similar devices.</p>	<p>COMMAND</p> <pre>#IDV<CR></pre> <p>FEEDBACK</p> <pre>~nn@IDV _ok<CR><LF></pre>		<pre>#IDV<CR></pre>
IR-SND	<p>Send IR command to port.</p>	<p>COMMAND</p> <pre>#IR-SND _ir_index,sn_id,cmd_name,repeat_amount,total_packages,package_id,<pronto_command..><CR></pre> <p>FEEDBACK</p> <pre>~nn@IR-SND _ir_index,sn_id,cmd_name,ir_status<CR><LF></pre>	<p>ir_index – Number that indicates the specific ir port: 1-N (N= the total number of inputs) * - broadcasts to all ports</p> <p>sn_id – Serial number of command for flow control and response commands from device</p> <p>cmd_name – Command name (length limit 15 chars)</p> <p>repeat_amount – Of times the IR command is transmitted (limited to 50; repeats > 50 are truncated to 50), default = 1</p> <p>total_packages – Number of messages the original command was divided into, default = 1</p> <p>package_id – Chunk serial number (only valid when Total_packages >1)</p> <p>pronto_command – Pronto format command (in HEX format, no leading zeros, no '0x' prefix)</p> <p>ir_status – IR Status 0 – Sent (no error) 1 – Stop 2 – Done 3 – Busy 4 – Wrong Parameter 5 – Nothing to Stop 6 – Start 7 – Timeout 8 – Error</p>	<p>Send IR command to port:</p> <pre>#IR-SND _1,1,1,1,1,1,1,1<CR></pre>







IR-STOP	Send IR stop command to port.	COMMAND #IR-STOP, <u>ir_index</u> , <u>sn_id</u> , <u>cmd_name</u> <CR> FEEDBACK ~nn@IR-STOP, <u>ir_index</u> , <u>sn_id</u> , <u>cmd_name</u> , <u>ir_status</u> <CR><LF>	<u>ir_index</u> – Number that indicates the specific ir port: 1-N (N= the total number of inputs) * - broadcasts to all ports <u>sn_id</u> – Serial number of command for flow control and response commands from device <u>cmd_name</u> – String: IR command name limited to 15 chars. Controlling device must send the correct name (white space or commas forbidden) <u>ir_status</u> – IR Status 0 – Sent (no error) 1 – Stop 2 – Done 3 – Busy 4 – Wrong Parameter 5 – Nothing to Stop 6 – Start 7 – Timeout 8 – Error	Send IR stop command to IR Port 2: #IR-STOP, <u>2</u> , <u>1</u> , <u>power</u> <CR>
LABEL	Set input/output label	COMMAND #LABEL, <u>io_mode</u> , <u>io_index</u> , <u>switch</u> , <u>label_txt</u> <CR> FEEDBACK ~nn@LABEL, <u>io_mode</u> , <u>io_index</u> , <u>switch</u> , <u>label_txt</u> <CR><LF>	<u>io_mode</u> – Number that indicates the specific input: 0 – Input 1 – Output <u>io_index</u> – Number that indicates the specific input: For inputs – 1 – USB-C IN 1 2 – HDMI IN 2 3 – HDMI IN 3 For output 1 – HDMI output <u>switch</u> – 0 <u>label_txt</u> – Custom label string between 1 and 32 (at least one character and not bigger than 32).	Set the HDMI input label on: #LABEL, <u>0</u> , <u>2</u> , <u>0</u> , <u>hdmi</u> <CR>
LABEL?	Get input/output label	COMMAND #LABEL?, <u>io_mode</u> , <u>io_index</u> , <u>switch</u> , <u>label_txt</u> <CR> FEEDBACK ~nn@LABEL, <u>io_mode</u> , <u>io_index</u> , <u>switch</u> , <u>label_txt</u> <CR><LF>	<u>io_mode</u> – Number that indicates the specific input: 0 – Input 1 – Output <u>io_index</u> – Number that indicates the specific input: For inputs – 1 – USB-C IN 1 2 – HDMI IN 2 3 – HDMI IN 3 For output 1 – HDMI output <u>switch</u> – 0 <u>label_txt</u> – Custom label string between 1 and 32 (at least one character and not bigger than 32). label string	Get the HDMI input label: #LABEL?, <u>0</u> , <u>2</u> , <u>0</u> , <u>hdmi</u> <CR>
LOCK-EDID	Lock last read EDID.	COMMAND #LOCK-EDID, <u>in_index</u> , <u>lock_mode</u> <CR> FEEDBACK ~nn@LOCK-EDID, <u>in_index</u> , <u>lock_mode</u> <CR><LF>	<u>in_index</u> – Number that indicates the specific input: 1 – USB-C IN 2 – HDMI IN <u>lock_mode</u> – On/Off 0 – Off unlocks EDID 1 – On locks EDID	Lock the last read EDID from input 2: #LOCK-EDID, <u>2</u> , <u>1</u> <CR>
LOCK-EDID?	Get EDID Lock status.	COMMAND #LOCK-EDID?, <u>in_index</u> <CR> FEEDBACK ~nn@LOCK-EDID, <u>in_index</u> , <u>lock_mode</u> <CR><LF>	<u>in_index</u> – Number that indicates the specific input: 1 – USB-C IN 2 – HDMI IN <u>lock_mode</u> – On/Off 0 – Off unlocks EDID 1 – On locks EDID	Get input 2 Lock EDID status: #LOCK-EDID?, <u>2</u> <CR>

LOGIN	<p>Set protocol permission.</p> <p>i The permission system works only if security is enabled with the "SECUR" command.</p> <p>LOGIN allows the user to run commands with an End User or Administrator permission level. When the permission system is enabled, LOGIN enables running commands with the User or Administrator permission level. When set, login must be performed upon each connection.</p> <p>It is not mandatory to enable the permission system in order to use the device.</p> <p>In each device, some connections allow logging in to different levels. Some do not work with security at all.</p> <p>Connection may logout after timeout.</p>	<p>COMMAND</p> <pre>#LOGIN_login_level,password<CR></pre> <p>FEEDBACK</p> <pre>~nn@LOGIN_login_level,password_ok<CR><LF></pre> <p>or</p> <pre>~nn@LOGIN_err_004<CR><LF></pre> <p>(if bad password entered)</p>	<p>login_level – Level of permissions required (User or Admin)</p> <p>password – Predefined password (by PASS command). Default password is an empty string</p>	<p>Set the protocol permission level to Admin (when the password defined in the PASS command is 33333):</p> <pre>#LOGIN_admin,33333<CR></pre>
LOGIN?	<p>Get protocol permission state.</p> <p>i The permission system works only if security is enabled with the "SECUR" command.</p> <p>LOGIN allows the user to run commands with an End User or Administrator permission level. When the permission system is enabled, LOGIN enables running commands with the User or Administrator permission level. When set, login must be performed upon each connection.</p> <p>It is not mandatory to enable the permission system in order to use the device.</p> <p>In each device, some connections allow logging in to different levels. Some do not work with security at all.</p> <p>Connection may logout after timeout.</p>	<p>COMMAND</p> <pre>#LOGIN_login_level <CR></pre> <p>FEEDBACK</p> <pre>~nn@LOGIN_login_level,password_ok<CR><LF></pre> <p>or</p> <pre>~nn@LOGIN_err_004<CR><LF></pre> <p>(if bad password entered)</p>	<p>login_level – Level of permissions required (User or Admin)</p> <p>password – Predefined password (by PASS command). Default password is an empty string or NO SECURE if authentication is removed.</p>	<p>Get the protocol permission level to Admin:</p> <pre>#LOGIN?_admin<CR></pre>
LOGOUT	<p>Cancel current permission level.</p> <p>i Logs out from End User or Administrator permission levels to Not Secure.</p>	<p>COMMAND</p> <pre>#LOGOUT<CR></pre> <p>FEEDBACK</p> <pre>~nn@LOGOUT_ok<CR><LF></pre>		<pre>#LOGOUT<CR></pre>
MODEL?	<p>Get device model.</p>	<p>COMMAND</p> <pre>#MODEL?_<CR></pre> <p>FEEDBACK</p> <pre>~nn@MODEL_model_name<CR><LF></pre>	<p>model_name – String of up to 19 printable ASCII chars</p>	<p>Get the device model:</p> <pre>#MODEL?_<CR></pre>
NAME	<p>Set machine (DNS) name.</p> <p>i The machine name is not the same as the model name. The machine name is used to identify a specific machine or a network in use (with DNS feature on).</p>	<p>COMMAND</p> <pre>#NAME_machine_name<CR></pre> <p>FEEDBACK</p> <pre>~nn@NAME_machine_name<CR><LF></pre>	<p>machine_name – String of up to 15 alpha-numeric chars (can include hyphen, not at the beginning or end)</p>	<p>Set the DNS name of the device to room-442:</p> <pre>#NAME_room-442<CR></pre>

NAME?	Get machine (DNS) name. ① The machine name is not the same as the model name. The machine name is used to identify a specific machine or a network in use (with DNS feature on).	COMMAND #NAME?_<CR> FEEDBACK ~nn@NAME_ machine_name<CR><LF>	machine_name – String of up to 15 alpha-numeric chars (can include hyphen, not at the beginning or end)	Get the DNS name of the device: #NAME?_<CR>
NAME-RST	Reset machine (DNS) name to factory default. ① Factory default of machine (DNS) name is "KRAMER_" + 4 last digits of device serial number.	COMMAND #NAME-RST<CR> FEEDBACK ~nn@NAME-RST_ ok<CR><LF>		Reset the machine name (S/N last digits are 0102): #NAME-RST_ kramer_0102<CR>
NET-CONFIG	Set a network configuration. ① Parameters [DNS1] and [DNS2] are optional. ② For Backward compatibility, the id parameter can be omitted. In this case, the Network ID, by default, is 0, which is the Ethernet control port. ③ If the gateway address is not compliant to the subnet mask used for the host IP, the command will return an error. Subnet and gateway compliancy specified by RFC950.	COMMAND #NET-CONFIG_ netw_id, net_ip, net_mask, gateway, [dns1], [dns2] <CR> FEEDBACK ~nn@NET-CONFIG_ netw_id, net_ip, net_mask, gateway<CR><LF>>	netw_id – 0 net_ip – Network IP net_mask – Network mask gateway – Network gateway	Set the device network parameters to IP address 192.168.113.10, net mask 255.255.0.0, and gateway 192.168.0.1: #NET-CONFIG_0,192.168.113.10,255.255.0.0,192.168.0.1<CR>
NET-CONFIG?	Get a network configuration. ① Parameters [DNS1] and [DNS2] are optional. ② For Backward compatibility, the id parameter can be omitted. In this case, the Network ID, by default, is 0, which is the Ethernet control port. ③ If the gateway address is not compliant to the subnet mask used for the host IP, the command will return an error. Subnet and gateway compliancy specified by RFC950.	COMMAND #NET-CONFIG_ netw_id, net_ip, net_mask, gateway, [dns1], [dns2] <CR> FEEDBACK ~nn@NET-CONFIG_ netw_id, net_ip, net_mask, gateway<CR><LF>>	netw_id – 0 net_ip – Network IP net_mask – Network mask gateway – Network gateway	Get the device network parameters: #NET-CONFIG?_0<CR>
NET-DHCP?	Get DHCP mode. ① For Backward compatibility, the id parameter can be omitted. In this case, the Network ID, by default, is 0, which is the Ethernet control port.	COMMAND #NET-DHCP?_ netw_id<CR> FEEDBACK ~nn@NET-DHCP_ netw_id, dhcp_state<CR><LF>	netw_id – Network ID—the device network interface (if there are more than one). Counting is 0 based, meaning the control port is '0', additional ports are 1,2,3.... dhcp_state – 0 – Do not use DHCP. Use the IP set by the factory or using the net-ip or net-config command. 1 – Try to use DHCP. If unavailable, use the IP set by the factory or using the net-ip or net-config command.	Get DHCP mode for port 1: #NET-DHCP?_1<CR>
NET-GATE	Set gateway IP. ① A network gateway connects the device via another network and maybe over the Internet. Be careful of security issues. For proper settings consult your network administrator.	COMMAND #NET-GATE_ ip_address<CR> FEEDBACK ~nn@NET-GATE_ ip_address<CR><LF>	ip_address – Format: xxx.xxx.xxx.xxx	Set the gateway IP address to 192.168.0.1: #NET-GATE_192.168.000.001<CR>
NET-GATE?	Get gateway IP. ① A network gateway connects the device via another network and maybe over the Internet. Be aware of security problems.	COMMAND #NET-GATE?_<CR> FEEDBACK ~nn@NET-GATE_ ip_address<CR><LF>	ip_address – Format: xxx.xxx.xxx.xxx	Get the gateway IP address: #NET-GATE?_<CR>

NET-IP	Set IP address. i For proper settings consult your network administrator.	COMMAND #NET-IP_ip_address<CR> FEEDBACK ~nn@NET-IP_ip_address<CR><LF>	ip_address – Format: xxx.xxx.xxx.xxx	Set the IP address to 192.168.1.39: #NET-IP_192.168.001.039<CR>
NET-IP?	Get IP address.	COMMAND #NET-IP?_<CR> FEEDBACK ~nn@NET-IP_ip_address<CR><LF>	ip_address – Format: xxx.xxx.xxx.xxx	Get the IP address: #NET-IP?_<CR>
NET-MAC?	Get MAC address. i For backward compatibility, the id parameter can be omitted. In this case, the Network ID, by default, is 0, which is the Ethernet control port.	COMMAND #NET-MAC?_id<CR> FEEDBACK ~nn@NET-MAC_id,mac_address<CR><LF>	id – Network ID—the device network interface (if there are more than one). Counting is 0 based, meaning the control port is '0', additional ports are 1,2,3.... mac_address – Unique MAC address. Format: XX-XX-XX-XX-XX-XX where X is hex digit	#NET-MAC?_id<CR>
NET-MASK	Set subnet mask. i For proper settings consult your network administrator.	COMMAND #NET-MASK_net_mask<CR> FEEDBACK ~nn@NET-MASK_net_mask<CR><LF>	net_mask – Format: xxx.xxx.xxx.xxx	Set the subnet mask to 255.255.0.0: #NET-MASK_255.255.000.000<CR>
NET-MASK?	Get subnet mask.	COMMAND #NET-MASK?_<CR> FEEDBACK ~nn@NET-MASK_net_mask<CR><LF>	net_mask – Format: xxx.xxx.xxx.xxx	Get the subnet mask: #NET-MASK?_<CR>
PASS	Set password for login level. i The default password is an empty string.	COMMAND #PASS_login_level,password<CR> FEEDBACK ~nn@PASS_login_level,password<CR><LF>	login_level – Level of login to set (End User or Administrator). password – Password for the login_level. Up to 15 printable ASCII chars	Set the password for the Admin protocol permission level to 33333: #PASS_admin,33333<CR>
PASS?	Get password for login level. i The default password is an empty string.	COMMAND #PASS_login_level <CR> FEEDBACK ~nn@PASS_login_level,password<CR><LF>	login_level – Level of login to set (End User or Administrator). password – Password for the login_level. Up to 15 printable ASCII chars	Get the password for the Admin protocol permission: #PASS?_admin<CR>
PRG-ACTION	Add new user command. i Programs matrix action as a response for external event (programmable button pressed).	COMMAND #PRG-ACTION_commandNum,type,name,command<CR> FEEDBACK ~nn@PRG-ACTION_commandNum,type,name,command<CR><LF>	commandNum – Command number 0 to 4 type – External programmable button cec name – Bitmap representing command – External programmable button ID	Add a new user command: #PRG-ACTION_1,3,1,0<CR>
PRG-ACTION?	Add new user command. i Programs matrix action as a response for external event (programmable button pressed).	COMMAND #PRG-ACTION?_commandNum<CR> FEEDBACK ~nn@PRG-ACTION_commandNum,type,name,command<CR><LF>	commandNum – Command number 0 – Input 1 – Output type – External programmable button ID name – Bitmap representing command – External programmable button ID	Add a new user command: #PRG-ACTION?_0,3,1,0<CR>

PRG-BTN-ACTION	Set program button mode	<p>COMMAND</p> <pre>#PROG-BTN- MOD_ btnNum,mode,actionOn,actionOff,btnBehavior<CR></pre> <p>FEEDBACK</p> <pre>~nn@PROG-BTN- MOD_ btnNum,mode,actionOn,actionOff,btnBehavior<CR><LF> ></pre>	<p>btnNum – Button number 0 to 4 1 and 2 are enabled when remote button is (mode) On</p> <ul style="list-style-type: none"> 1 – IO 1 button 2 – IO 2 button 3 – Display On button <p>mode – Remote button state</p> <ul style="list-style-type: none"> 0 – Off 1 – On <p>actionOn –</p> <ul style="list-style-type: none"> 100 – None 101 – Switch Input 102 – Display On (via CEC) 103 – Display Off (via CEC) 104 – Mute 105 – Unmute 106 – Volume ++ 107 – Volume -- 0 – Command_01 1 – Command_02 2 – Command_03 3 – Command_04 4 – Custom 5 <p>actionOff – Button_mode</p> <ul style="list-style-type: none"> 100 – None 101 – Switch Input 102 – Display On (via CEC) 103 – Display Off (via CEC) 104 – Mute 105 – Unmute 106 – Volume ++ 107 – Volume -- 0 – Command_01 1 – Command_02 2 – Command_03 3 – Command_04 4 – Custom 5 <p>btnBehavior – Button_mode</p> <ul style="list-style-type: none"> 0 – Momentary mode disabled 1 – Momentary mode enabled 	Set the DISPLAY ON button to mute/unmute with the press of a button: #PROG-BTN-MOD_3,1,104,105,0<CR>
PROG-BTN-MOD?	Get programmable buttons mode	<p>COMMAND</p> <pre>#PROG-BTN-MOD?<CR></pre> <p>FEEDBACK</p> <pre>~nn@PROG-BTN-MOD_ button_mode<CR><LF></pre>	<p>btnNum – Button number 0 to 4 1 and 2 are enabled when remote button is (mode) On</p> <ul style="list-style-type: none"> 1 – IO 1 button 2 – IO 2 button 3 – Display On button <p>mode – Remote button state</p> <ul style="list-style-type: none"> 0 – Off 1 – On <p>actionOn –</p> <ul style="list-style-type: none"> 100 – None 101 – Switch Input 102 – Display On (via CEC) 103 – Display Off (via CEC) 104 – Mute 105 – Unmute 106 – Volume ++ 107 – Volume -- 0 – Command_01 1 – Command_02 2 – Command_03 3 – Command_04 4 – Custom 5 <p>actionOff – Button_mode</p> <ul style="list-style-type: none"> 100 – None 101 – Switch Input 102 – Display On (via CEC) 103 – Display Off (via CEC) 104 – Mute 105 – Unmute 106 – Volume ++ 107 – Volume -- 0 – Command_01 1 – Command_02 2 – Command_03 3 – Command_04 4 – Custom 5 <p>btnBehavior – Button_mode</p> <ul style="list-style-type: none"> 0 – Momentary mode disabled 1 – Momentary mode enabled 	Get the mode of button 3: #PROG-BTN-MOD?_3<CR>
PRIORITY	Set input priority.	<p>COMMAND</p> <pre>#PRIORITY_ layer_type,priority_1,priority_2,priority_3 <CR></pre> <p>FEEDBACK</p> <pre>~nn@PRIORITY_ layer_type,priority_1,priority_2,priorit y_3<CR><LF></pre>	<p>layer_type – Layer Enumeration</p> <ul style="list-style-type: none"> 1 – Video <p>priority – Priority of inputs (1-2)</p> <ul style="list-style-type: none"> 1 – USB-C 1 2 – HDMI 2 3 – HDMI 3 	Set the priority to first HDMI 2, USB-C 1 second and HDMI 3 third: #PRIORITY_1,2,1,3<CR>

PRIORITY?	Set input priority.	COMMAND #PRIORITY?_layer_type<CR> FEEDBACK ~nn@PRIORITY_layer_type,priority_1,priority_2,priority_3<CR><LF>	layer_type – Layer Enumeration 1 – Video priority – Priority of inputs (1-2) 1 – USB-C 1 2 – HDMI 2 3 – HDMI 3	Get the input priority: #PRIORITY?_1<CR>
PROT-VER?	Get device protocol version.	COMMAND #PROT-VER?_<CR> FEEDBACK ~nn@PROT-VER_3000:version<CR><LF>	version – XX.XX where X is a decimal digit	Get the device protocol version: #PROT-VER?_<CR>
RELAY-STATE	Set relay state.	COMMAND #RELAY-STATEV_relay_id,state<CR> FEEDBACK ~nn@RELAY-STATE_relay_id,state<CR><LF>	relay_id: – Relay number1-2 state: – Relay state 0 – (open) 1 – (close)	Set relay 2 to closed: #RELAY-STATE_<CR>
RELAY-STATE?	Get relay state.	COMMAND #RESET<CR> #RELAY-STATE?_relay_id<CR> FEEDBACK ~nn@RESET_ok<CR><LF>	relay_id: – Relay number1-2 state: – Relay state 0 – (open) 1 – (close)	Get relay state: #RELAY-STATE?_<CR>
ROUTE	Set layer routing.  This command replaces all other routing commands.	COMMAND #ROUTE_layer_type,out_index,in_index<CR> FEEDBACK ~nn@ROUTE_layer_type,out_index,in_index<CR><LF>	layer_type Layer Enumeration 1 – Video 5 – USB out_index 1 – Output in_index – Source id for Video: 1 – USB-C 1 2 – HDMI IN 2 3 – HDMI IN 3	Route video input 2 to the output: #ROUTE_1,1,2<CR>
ROUTE?	Get layer routing state.  This command replaces all other routing commands.	COMMAND #ROUTE?_layer_type,out_index<CR> FEEDBACK ~nn@ROUTE_layer_type,out_index,in_index <CR><LF>	layer_type Layer Enumeration 1 – Video 5 – USB out_index 1 – Output in_index – Source id for Video: 1 – USB-C 1 2 – HDMI IN 2 3 – HDMI IN 3	Get video routing output: #ROUTE?_1,1<CR>
SECUR	Start/stop security.  The permission system works only if security is enabled with the "SECUR" command.	COMMAND #SECUR_security_state<CR> FEEDBACK ~nn@SECUR_security_state<CR><LF>	security_state – Security state 0 – OFF (disables security) 1 – ON (enables security)	Enable the permission system: #SECUR_1<CR>
SECUR?	Get security state.  The permission system works only if security is enabled with the "SECUR" command.	COMMAND #SECUR?_security_state<CR> FEEDBACK ~nn@SECUR_security_state<CR><LF>	security_state – Security state 0 – OFF (disables security) 1 – ON (enables security)	Enable the permission system: #SECUR?_<CR>
SIGNAL?	Get input signal status.	COMMAND #SIGNAL?_in_index<CR> FEEDBACK ~nn@SIGNAL_in_index,status<CR><LF>	in_index – Number that indicates the specific input: 1 – USB-C IN 1 2 – HDMI IN 2 3 – HDMI IN 3 status – Signal status according to signal validation: 0 – Off 1 – On	Get the input signal lock status of IN 1: #SIGNAL?_1<CR>
SN?	Get device serial number.	COMMAND #SN?_<CR> FEEDBACK ~nn@SN_serial_num<CR><LF>	serial_num – 14 decimal digits, factory assigned	Get the device serial number: #SN?_<CR>
TIME	Set device time and date.  The year must be 4 digits. The device does not validate the day of week from the date. Time format - 24 hours. Date format - Day, Month, Year.	COMMAND #TIME_day_of_week,date,data<CR> FEEDBACK ~nn@TIME_day_of_week,date,data<CR><LF>	day_of_week – One of (SUN,MON,TUE,WED,THU,FRI,SAT) date – Format: DD-MM-YYYY. data – Format: hh:mm:ss where hh = hours mm = minutes ss = seconds	Set device time and date to December 5, 2020 at 2:30pm: #TIME_mon_05-12-2020,14:30:00<CR>
TIME?	Get device time and date.  The year must be 4 digits. The device does not validate the day of week from the date. Time format - 24 hours. Date format - Day, Month, Year.	COMMAND #TIME?_<CR> FEEDBACK ~nn@TIME_day_of_week,date,data<CR><LF>	day_of_week – One of (SUN,MON,TUE,WED,THU,FRI,SAT) date – Format: YYYY/MM/DD where YYYY = Year MM = Month DD = Day data – Format: hh:mm:ss where hh = hours mm = minutes ss = seconds	Get device time and date: #TIME?<CR>

TIME-LOC	<p>Set local time offset from UTC/GMT.</p> <p>i If the time server is configured, device time calculates by adding UTC_off to UTC time (that it got from the time server) + 1 hour if daylight savings time is in effect.</p> <p>TIME command sets the device time without considering these settings.</p>	<p>COMMAND</p> <pre>#TIME-LOC,<_>utc_off,<_>dst_state<CR></pre> <p>FEEDBACK</p> <pre>~nn@TIME-LOC,<_>utc_off,<_>dst_state<CR><LF></pre>	<p>utc_off – Offset of device time from UTC/GMT (without daylight time correction)</p> <p>dst_state – Daylight saving time state</p> <p>0 – no daylight saving time</p> <p>1 – daylight saving time</p>	<p>Set local time offset to 3 with no daylight-saving time:</p> <pre>#TIME-LOC,<_>3,0<CR></pre>
TIME-LOC?	<p>Get local time offset from UTC/GMT.</p> <p>i If the time server is configured, device time calculates by adding UTC_off to UTC time (that it got from the time server) + 1 hour if daylight savings time is in effect.</p> <p>TIME command sets the device time without considering these settings.</p>	<p>COMMAND</p> <pre>#TIME-LOC?,<_><CR></pre> <p>FEEDBACK</p> <pre>~nn@TIME-LOC,<_>utc_off,<_>dst_state<CR><LF></pre>	<p>utc_off – Offset of device time from UTC/GMT (without daylight time correction)</p> <p>dst_state – Daylight saving time state</p> <p>0 – no daylight saving time</p> <p>1 – daylight saving time</p>	<p>Get local time offset from UTC/GMT:</p> <pre>#TIME-LOC?<CR></pre>
TIME-SRV	<p>Set time server.</p> <p>i This command is needed for setting UDP timeout for the current client list.</p>	<p>COMMAND</p> <pre>#TIME-SRV,<_>mode,<_>time_server_ip,<_>sync_hour<CR></pre> <p>FEEDBACK</p> <pre>~nn@TIME-SRV,<_>mode,<_>time_server_ip,<_>sync_hour,<_>server_status<CR><LF></pre>	<p>mode – On/Off</p> <p>0 – Off</p> <p>1 – On</p> <p>time_server_ip – Time server IP address</p> <p>sync_hour – Hour in day for time server sync</p> <p>server_status – On/Off</p>	<p>Set time server with IP address of 128.138.140.44 to ON:</p> <pre>#TIME-SRV,<_>1,128.138.140.44,0,1<CR></pre>
TIME-SRV?	<p>Get time server.</p> <p>i This command is needed for setting UDP timeout for the current client list.</p>	<p>COMMAND</p> <pre>#TIME-SRV?,<_><CR></pre> <p>FEEDBACK</p> <pre>~nn@TIME-SRV,<_>mode,<_>time_server_ip,<_>sync_hour,<_>server_status<CR><LF></pre>	<p>mode – On/Off</p> <p>0 – Off</p> <p>1 – On</p> <p>time_server_ip – Time server IP address</p> <p>sync_hour – Hour in day for time server sync</p> <p>server_status – On/Off</p>	<p>Get time server:</p> <pre>#TIME-SRV?<CR></pre>
TXRX-MODE	<p>Set tx/rx mode.</p> <p>i This command will reset the device and restore factory defaults.</p>	<p>COMMAND</p> <pre>#TXRX-MODE,<_>hdbt_port_id,<_>hdbt_mode<CR></pre> <p>FEEDBACK</p> <pre>~nn@TXRX-MODE,<_>hdbt_port_id,<_>hdbt_mode<CR><LF></pre>	<p>hdbt_port_id: HDBT port number</p> <p>hdbt_mode: HDBT mode</p> <p>0-Transmitter</p> <p>1-Receiver</p>	<p>Set device in Transmitter mode</p> <pre>#TXRX-MODE,<_>1,0<CR></pre>
TXRX-MODE?	<p>Get tx/rx mode.</p>	<p>COMMAND</p> <pre>#TXRX-MODE?,<_>hdbt_port_id<CR></pre> <p>FEEDBACK</p> <pre>~nn@TXRX-MODE,<_>hdbt_port_id,<_>hdbt_mode<CR><LF></pre>	<p>hdbt_port_id: HDBT port number</p> <p>hdbt_mode: HDBT mode</p> <p>0-Transmitter</p> <p>1-Receiver</p>	<p>Set device in Transmitter mode</p> <pre>#TXRX-MODE?,<_>1,<_><CR></pre>
UART	<p>Set com port configuration.</p> <p>i In the FC-2x the serial port is selectable to RS-232 or RS-485 (usually serial port 1).</p> <p>If Serial is configured when RS-485 is selected, the RS-485 UART port automatically changes.</p> <p>The command is backward compatible, meaning that if the extra parameters do not exist, FW goes to RS-232.</p> <p>Stop_bits 1.5 is only relevant for 5 data_bits.</p>	<p>COMMAND</p> <pre>#UART,<_>com_id,<_>baud_rate,<_>data_bits,<_>parity,<_>stop_bits_mode,<_>serial_type,<_>485_term<CR></pre> <p>FEEDBACK</p> <pre>~nn@UART,<_>com_id,<_>baud_rate,<_>data_bits,<_>parity,<_>stop_bits_mode,<_>serial_type,<_>485_term<CR><LF></pre>	<p>com_id – 1 to n (machine dependent)</p> <p>baud_rate – 9600 - 115200</p> <p>data_bits – 5-8</p> <p>parity – Parity Type</p> <p>0 – No</p> <p>1 – Odd</p> <p>2 – Even</p> <p>3 – Mark</p> <p>4 – Space</p> <p>stop_bits_mode – 1/1.5/2</p> <p>serial_type – 232/485</p> <p>0 – 232</p> <p>1 – 485</p> <p>485_term – 485 termination state</p> <p>0 – disable</p> <p>1 – enable</p> <p>(optional - this exists only when serial_type is 485)</p>	<p>Set baud rate to 9600, 8 data bits, parity to none and stop bit to 1:</p> <pre>#UART,<_>9600,8,<_>node,<_>1<CR></pre>

UART?	Get com port configuration. The command is backward compatible, meaning that if the extra parameters do not exist, FW goes to RS-232. Stop_bits 1.5 is only relevant for 5 data_bits.	COMMAND #UART?_com_id<CR> FEEDBACK ~nn@UART_com_id,baud_rate,data_bits,parity,stop_bits_mode,serial_type,485_term<CR><LF>	com_id – 1 to n (machine dependent) baud_rate – 9600 - 115200 data_bits – 5-8 parity – Parity Type 0 – No 1 – Odd 2 – Even 3 – Mark 4 – Space stop_bits_mode – 1/1.5/2 serial_type – 232/485 0 – 232 1 – 485 485_term – 485 termination state 0 – disable 1 – enable (optional - this exists only when serial_type is 485)	Set baud rate to 9600, 8 data bits, parity to none and stop bit to 1: #UART_1,9600,8,node,1<CR>
USB-FV	Set USB auto-switching mode.	COMMAND #USB-FV_mode<CR> FEEDBACK ~nn@USB-FV_mode<CR><LF>	mode – On/Off 0 – Off 1 – On	Set auto-switching mode to ON: #USB-FV_1<CR>
USB-FV?	Get USB auto-switching mode.	COMMAND #USB-FV?_mode<CR> FEEDBACK ~nn@USB-FV_mode<CR><LF>	mode – On/Off 0 – Off 1 – On	Set auto-switching mode to ON: #USB-FV_1<CR>
USBA-DISCONNECT-MODE	Set USB device auto-disconnection mode..	COMMAND #USBA-DISCONNECT-MODE_USBDevice_mode<CR> FEEDBACK ~nn@USBA-DISCONNECT-MODE_mode<CR><LF>	USBDevice – USB device number 1 – USB Device 1 2 – USB Device 2 3 – USB Device 3 4 – USB Device 4 mode – On/Off 0 – Off 1 – On	Set USB Device 1 polycorn mode to ON: #USBA-DISCONNECT-MODE_1,1<CR>
USBA-DISCONNECT-MODE?	Get USB device auto-disconnection mode..	COMMAND #USBA-DISCONNECT-MODE?_USBDevice<CR> FEEDBACK ~nn@USBA-DISCONNECT-MODE_mode<CR><LF>	USBDevice – USB device number 1 – USB Device 1 2 – USB Device 2 3 – USB Device 3 4 – USB Device 4 mode – On/Off 0 – Off 1 – On	Get USB Device 1 polycorn mode: #USBA-DISCONNECT-MODE?_1<CR>
VERSION?	Get firmware version number.	COMMAND #VERSION?_firmware_version<CR> FEEDBACK ~nn@VERSION_firmware_version<CR><LF>	firmware_version – XX.XX.XXXX where the digit groups are: major.minor.build version	Get the device firmware version number: #VERSION?_firmware_version<CR>
VMUTE	Set enable/disable video on output. ⓘ Video mute parameter 2 (blank picture) is not supported.	COMMAND #VMUTE_out_index,flag<CR> FEEDBACK ~nn@VMUTE_out_index,flag<CR><LF>	out_index – Number that indicates the specific output – 1 flag – Video Mute 0 – Video enabled 1 – Video disabled 2 – Blank picture	Disable the video output on output: #VMUTE_1,0<CR>
VMUTE?	Get video on output status. ⓘ Video mute parameter 2 (blank picture) is not supported.	COMMAND #VMUTE?_out_index<CR> FEEDBACK ~nn@VMUTE_out_index,flag<CR><LF>	out_index – Number that indicates the specific output – 1 flag – Video Mute 0 – Video enabled 1 – Video disabled 2 – Blank picture	Get video on output status: #VMUTE?_1<CR>

Result and Error Codes

Syntax

In case of an error, the device responds with an error message. The error message syntax:

- ~NN@ERR XXX<CR><LF> – when general error, no specific command
- ~NN@CMD ERR XXX<CR><LF> – for specific command
- NN – machine number of device, default = 01
- XXX – error code

Error Codes

Error Name	Error Code	Description
P3K_NO_ERROR	0	No error
ERR_PROTOCOL_SYNTAX	1	Protocol syntax
ERR_COMMAND_NOT_AVAILABLE	2	Command not available
ERR_PARAMETER_OUT_OF_RANGE	3	Parameter out of range
ERR_UNAUTHORIZED_ACCESS	4	Unauthorized access
ERR_INTERNAL_FW_ERROR	5	Internal FW error
ERR_BUSY	6	Protocol busy
ERR_WRONG_CRC	7	Wrong CRC
ERR_TIMEDOUT	8	Timeout
ERR_RESERVED	9	(Reserved)
ERR_FW_NOT_ENOUGH_SPACE	10	Not enough space for data (firmware, FPGA...)
ERR_FS_NOT_ENOUGH_SPACE	11	Not enough space – file system
ERR_FS_FILE_NOT_EXISTS	12	File does not exist
ERR_FS_FILE_CANT_CREATED	13	File can't be created
ERR_FS_FILE_CANT_OPEN	14	File can't open
ERR_FEATURE_NOT_SUPPORTED	15	Feature is not supported
ERR_RESERVED_2	16	(Reserved)
ERR_RESERVED_3	17	(Reserved)
ERR_RESERVED_4	18	(Reserved)
ERR_RESERVED_5	19	(Reserved)
ERR_RESERVED_6	20	(Reserved)
ERR_PACKET_CRC	21	Packet CRC error
ERR_PACKET_MISSED	22	Packet number isn't expected (missing packet)
ERR_PACKET_SIZE	23	Packet size is wrong
ERR_RESERVED_7	24	(Reserved)
ERR_RESERVED_8	25	(Reserved)
ERR_RESERVED_9	26	(Reserved)
ERR_RESERVED_10	27	(Reserved)
ERR_RESERVED_11	28	(Reserved)
ERR_RESERVED_12	29	(Reserved)
ERR_EDID_CORRUPTED	30	EDID corrupted
ERR_NON_LISTED	31	Device specific errors
ERR_SAME_CRC	32	File has the same CRC – not changed
ERR_WRONG_MODE	33	Wrong operation mode
ERR_NOT_CONFIGURED	34	Device/chip was not initialized

The warranty obligations of Kramer Electronics Inc. ("Kramer Electronics") for this product are limited to the terms set forth below:

What is Covered

This limited warranty covers defects in materials and workmanship in this product.

What is Not Covered

This limited warranty does not cover any damage, deterioration or malfunction resulting from any alteration, modification, improper or unreasonable use or maintenance, misuse, abuse, accident, neglect, exposure to excess moisture, fire, improper packing and shipping (such claims must be presented to the carrier), lightning, power surges, or other acts of nature. This limited warranty does not cover any damage, deterioration or malfunction resulting from the installation or removal of this product from any installation, any unauthorized tampering with this product, any repairs attempted by anyone unauthorized by Kramer Electronics to make such repairs, or any other cause which does not relate directly to a defect in materials and/or workmanship of this product. This limited warranty does not cover cartons, equipment enclosures, cables or accessories used in conjunction with this product.

Without limiting any other exclusion herein, Kramer Electronics does not warrant that the product covered hereby, including, without limitation, the technology and/or integrated circuit(s) included in the product, will not become obsolete or that such items are or will remain compatible with any other product or technology with which the product may be used.

How Long this Coverage Lasts

The standard limited warranty for Kramer products is seven (7) years from the date of original purchase, with the following exceptions:

1. All Kramer VIA hardware products are covered by a standard three (3) year warranty for the VIA hardware and a standard three (3) year warranty for firmware and software updates; all Kramer VIA accessories, adapters, tags, and dongles are covered by a standard one (1) year warranty.
2. Kramer fiber optic cables, adapter-size fiber optic extenders, pluggable optical modules, active cables, cable retractors, ring mounted adapters, portable power chargers, Kramer speakers, and Kramer touch panels are covered by a standard one (1) year warranty. Kramer 7-inch touch panels purchased on or after April 1st, 2020 are covered by a standard two (2) year warranty.
3. All Kramer Calibre products, all Kramer Minicom digital signage products, all HighSecLabs products, all streaming, and all wireless products are covered by a standard three (3) year warranty.
4. All Sierra Video MultiViewers are covered by a standard five (5) year warranty.
5. Sierra switchers & control panels are covered by a standard seven (7) year warranty (excluding power supplies and fans that are covered for three (3) years).
6. K-Touch software is covered by a standard one (1) year warranty for software updates.
7. All Kramer passive cables are covered by a lifetime warranty.

Who is Covered

Only the original purchaser of this product is covered under this limited warranty. This limited warranty is not transferable to subsequent purchasers or owners of this product.

What Kramer Electronics Will Do

Kramer Electronics will, at its sole option, provide one of the following three remedies to whatever extent it shall deem necessary to satisfy a proper claim under this limited warranty:

1. Elect to repair or facilitate the repair of any defective parts within a reasonable period of time, free of any charge for the necessary parts and labor to complete the repair and restore this product to its proper operating condition. Kramer Electronics will also pay the shipping costs necessary to return this product once the repair is complete.
2. Replace this product with a direct replacement or with a similar product deemed by Kramer Electronics to perform substantially the same function as the original product. If a direct or similar replacement product is supplied, the original product's end warranty date remains unchanged and is transferred to the replacement product.
3. Issue a refund of the original purchase price less depreciation to be determined based on the age of the product at the time remedy is sought under this limited warranty.

What Kramer Electronics Will Not Do Under This Limited Warranty

If this product is returned to Kramer Electronics or the authorized dealer from which it was purchased or any other party authorized to repair Kramer Electronics products, this product must be insured during shipment, with the insurance and shipping charges prepaid by you. If this product is returned uninsured, you assume all risks of loss or damage during shipment. Kramer Electronics will not be responsible for any costs related to the removal or re-installation of this product from or into any installation. Kramer Electronics will not be responsible for any costs related to any setting up this product, any adjustment of user controls or any programming required for a specific installation of this product.

How to Obtain a Remedy Under This Limited Warranty

To obtain a remedy under this limited warranty, you must contact either the authorized Kramer Electronics reseller from whom you purchased this product or the Kramer Electronics office nearest you. For a list of authorized Kramer Electronics resellers and/or Kramer Electronics authorized service providers, visit our web site at www.kramerav.com or contact the Kramer Electronics office nearest you.

In order to pursue any remedy under this limited warranty, you must possess an original, dated receipt as proof of purchase from an authorized Kramer Electronics reseller. If this product is returned under this limited warranty, a return authorization number, obtained from Kramer Electronics, will be required (RMA number).

You may also be directed to an authorized reseller or a person authorized by Kramer Electronics to repair the product.

If it is decided that this product should be returned directly to Kramer Electronics, this product should be properly packed, preferably in the original carton, for shipping. Cartons not bearing a return authorization number will be refused.

Limitation of Liability

THE MAXIMUM LIABILITY OF KRAMER ELECTRONICS UNDER THIS LIMITED WARRANTY SHALL NOT EXCEED THE ACTUAL PURCHASE PRICE PAID FOR THE PRODUCT. TO THE MAXIMUM EXTENT PERMITTED BY LAW, KRAMER ELECTRONICS IS NOT RESPONSIBLE FOR DIRECT, SPECIAL, INCIDENTAL OR CONSEQUENTIAL DAMAGES RESULTING FROM ANY BREACH OF WARRANTY OR CONDITION, OR UNDER ANY OTHER LEGAL THEORY. Some countries, districts or states do not allow the exclusion or limitation of relief, special, incidental, consequential or indirect damages, or the limitation of liability to specified amounts, so the above limitations or exclusions may not apply to you.

Exclusive Remedy

TO THE MAXIMUM EXTENT PERMITTED BY LAW, THIS LIMITED WARRANTY AND THE REMEDIES SET FORTH ABOVE ARE EXCLUSIVE AND IN LIEU OF ALL OTHER WARRANTIES, REMEDIES AND CONDITIONS, WHETHER ORAL OR WRITTEN, EXPRESS OR IMPLIED. TO THE MAXIMUM EXTENT PERMITTED BY LAW, KRAMER ELECTRONICS SPECIFICALLY DISCLAIMS ANY AND ALL IMPLIED WARRANTIES, INCLUDING, WITHOUT LIMITATION, WARRANTIES OF MERCHANTABILITY AND FITNESS FOR A PARTICULAR PURPOSE. IF KRAMER ELECTRONICS CANNOT LAWFULLY DISCLAIM OR EXCLUDE IMPLIED WARRANTIES UNDER APPLICABLE LAW, THEN ALL IMPLIED WARRANTIES COVERING THIS PRODUCT, INCLUDING WARRANTIES OF MERCHANTABILITY AND FITNESS FOR A PARTICULAR PURPOSE, SHALL APPLY TO THIS PRODUCT AS PROVIDED UNDER APPLICABLE LAW. IF ANY PRODUCT TO WHICH THIS LIMITED WARRANTY APPLIES IS A "CONSUMER PRODUCT" UNDER THE MAGNUSON-MOSS WARRANTY ACT (15 U.S.C.A. §2301, ET SEQ.) OR OTHER APPLICABLE LAW, THE FOREGOING DISCLAIMER OF IMPLIED WARRANTIES SHALL NOT APPLY TO YOU, AND ALL IMPLIED WARRANTIES ON THIS PRODUCT, INCLUDING WARRANTIES OF MERCHANTABILITY AND FITNESS FOR THE PARTICULAR PURPOSE, SHALL APPLY AS PROVIDED UNDER APPLICABLE LAW.

Other Conditions

This limited warranty gives you specific legal rights, and you may have other rights which vary from country to country or state to state.

This limited warranty is void if (i) the label bearing the serial number of this product has been removed or defaced, (ii) the product is not distributed by Kramer Electronics or (iii) this product is not purchased from an authorized Kramer Electronics reseller. If you are unsure whether a reseller is an authorized Kramer Electronics reseller, visit our web site at www.kramerav.com or contact a Kramer Electronics office from the list at the end of this document.

Your rights under this limited warranty are not diminished if you do not complete and return the product registration form or complete and submit the online product registration form. Kramer Electronics thanks you for purchasing a Kramer Electronics product. We hope it will give you years of satisfaction.



HDMI™
HIGH-DEFINITION MULTIMEDIA INTERFACE



P/N:



0000-000000

Rev:



2



SAFETY WARNING

Disconnect the unit from the power supply before opening and servicing

For the latest information on our products and a list of Kramer distributors, visit our website where updates to this user manual may be found.

We welcome your questions, comments, and feedback.

The terms HDMI, HDMI High-Definition Multimedia Interface, and the HDMI Logo are trademarks or registered trademarks of HDMI Licensing Administrator, Inc. All brand names, product names, and trademarks are the property of their respective owners.