

**ASUS<sup>®</sup>**

**PA27DCE**

**OLED Monitor**

*User Guide*

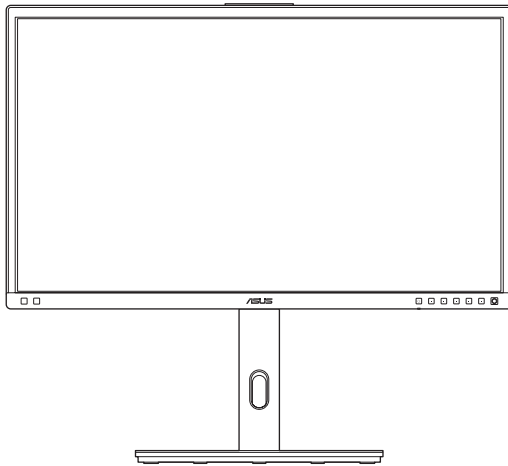

**HDMI<sup>™</sup>**  
HIGH-DEFINITION MULTIMEDIA INTERFACE

First Edition  
March 2023

**Copyright © 2023 ASUSTeK COMPUTER INC. All Rights Reserved.**

No part of this manual, including the products and software described in it, may be reproduced, transmitted, transcribed, stored in a retrieval system, or translated into any language in any form or by any means, except documentation kept by the purchaser for backup purposes, without the express written permission of ASUSTeK COMPUTER INC. ("ASUS").

Product warranty or service will not be extended if: (1) the product is repaired, modified or altered, unless such repair, modification of alteration is authorized in writing by ASUS; or (2) the serial number of the product is defaced or missing.

ASUS PROVIDES THIS MANUAL "AS IS" WITHOUT WARRANTY OF ANY KIND, EITHER EXPRESS OR IMPLIED, INCLUDING BUT NOT LIMITED TO THE IMPLIED WARRANTIES OR CONDITIONS OF MERCHANTABILITY OR FITNESS FOR A PARTICULAR PURPOSE. IN NO EVENT SHALL ASUS, ITS DIRECTORS, OFFICERS, EMPLOYEES OR AGENTS BE LIABLE FOR ANY INDIRECT, SPECIAL, INCIDENTAL, OR CONSEQUENTIAL DAMAGES (INCLUDING DAMAGES FOR LOSS OF PROFITS, LOSS OF BUSINESS, LOSS OF USE OR DATA, INTERRUPTION OF BUSINESS AND THE LIKE), EVEN IF ASUS HAS BEEN ADVISED OF THE POSSIBILITY OF SUCH DAMAGES ARISING FROM ANY DEFECT OR ERROR IN THIS MANUAL OR PRODUCT.

SPECIFICATIONS AND INFORMATION CONTAINED IN THIS MANUAL ARE FURNISHED FOR INFORMATIONAL USE ONLY, AND ARE SUBJECT TO CHANGE AT ANY TIME WITHOUT NOTICE, AND SHOULD NOT BE CONSTRUED AS A COMMITMENT BY ASUS. ASUS ASSUMES NO RESPONSIBILITY OR LIABILITY FOR ANY ERRORS OR INACCURACIES THAT MAY APPEAR IN THIS MANUAL, INCLUDING THE PRODUCTS AND SOFTWARE DESCRIBED IN IT.

Products and corporate names appearing in this manual may or may not be registered trademarks or copyrights of their respective companies, and are used only for identification or explanation and to the owners' benefit, without intent to infringe.

# Contents

Notices.....	iv
Safety information .....	v
Care & Cleaning .....	vi
Takeback Services.....	vii
Product information for EU energy label.....	vii

## Chapter 1: Product introduction

1.1	Welcome! .....	1-1
1.2	Package contents.....	1-1
1.3	Monitor introduction .....	1-2
1.3.1	Front view .....	1-2
1.3.2	Back view .....	1-4
1.3.3	QuickFit Plus Function .....	1-5
1.3.4	Other Function(s) .....	1-7

## Chapter 2: Setup

2.1	Attaching the stand (arm/base) .....	2-1
2.2	Detaching the stand (for VESA wall mount).....	2-3
2.3	Adjusting the monitor.....	2-4
2.4	Connecting the cables.....	2-6
2.5	Turning on the monitor.....	2-7

## Chapter 3: General instructions

3.1	OSD (On-Screen Display) menu .....	3-1
3.1.1	How to reconfigure.....	3-1
3.1.2	OSD function introduction .....	3-2
3.2	Specifications Summary .....	3-15
3.3	Outline dimensions.....	3-17
3.4	Troubleshooting (FAQ).....	3-19
3.5	Supported operating modes .....	3-20

# Notices

## Federal Communications Commission Statement

This device complies with Part 15 of the FCC Rules. Operation is subject to the following two conditions:

- This device may not cause harmful interference, and
- This device must accept any interference received including interference that may cause undesired operation.

This equipment has been tested and found to comply with the limits for a Class B digital device, pursuant to Part 15 of the FCC Rules. These limits are designed to provide reasonable protection against harmful interference in a residential installation. This equipment generates, uses and can radiate radio frequency energy and, if not installed and used in accordance with manufacturer's instructions, may cause harmful interference to radio communications. However, there is no guarantee that interference will not occur in a particular installation. If this equipment does cause harmful interference to radio or television reception, which can be determined by turning the equipment off and on, the user is encouraged to try to correct the interference by one or more of the following measures:

- Reorient or relocate the receiving antenna.
- Increase the separation between the equipment and receiver.
- Connect the equipment to an outlet on a circuit different from that to which the receiver is connected.
- Consult the dealer or an experienced radio/TV technician for help.



---

The use of shielded cables for connection of the monitor to the graphics card is required to assure compliance with FCC regulations. Changes or modifications to this unit not expressly approved by the party responsible for compliance could void the user's authority to operate this equipment.

---

## Canadian Department of Communications Statement

This digital apparatus does not exceed the Class B limits for radio noise emissions from digital apparatus set out in the Radio Interference Regulations of the Canadian Department of Communications.

This class B digital apparatus complies with Canadian ICES-003.

This Class B digital apparatus meets all requirements of the Canadian Interference - Causing Equipment Regulations.

Cet appareil numérique de la classe B respecte toutes les exigences du Règlement sur le matériel brouiller du Canada.

## Safety information

- Before setting up the monitor, carefully read all the documentation that came with the package.
- To prevent fire or shock hazard, never expose the monitor to rain or moisture.
- Never try to open the monitor cabinet. The dangerous high voltages inside the monitor may result in serious physical injury.
- If the power supply is broken, do not try to fix it by yourself. Contact a qualified service technician or your retailer.
- Before using the product, make sure all cables are correctly connected and the power cables are not damaged. If you detect any damage, contact your dealer immediately.
- Slots and openings on the back or top of the cabinet are provided for ventilation. Do not block these slots. Never place this product near or over a radiator or heat source unless proper ventilation is provided.
- The monitor should be operated only from the type of power source indicated on the label. If you are not sure of the type of power supply to your home, consult your dealer or local power company.
- Use the appropriate power plug which complies with your local power standard.
- The equipment power supply cord shall be connected to a socket-outlet with earthing connection.
- Do not overload power strips and extension cords. Overloading can result in fire or electric shock.
- Avoid dust, humidity, and temperature extremes. Do not place the monitor in any area where it may become wet. Place the monitor on a stable surface.
- Unplug the unit during a lightning storm or if it will not be used for a long period of time. This will protect the monitor from damage due to power surges.
- Never push objects or spill liquid of any kind into the slots on the monitor cabinet.
- To ensure satisfactory operation, use the monitor only with UL listed computers which have appropriate configured receptacles marked between 100-240V AC.
- If you encounter technical problems with the monitor, contact a qualified service technician or your retailer.
- Adjustment of the volume control as well as the equalizer to other settings than the center position may increase the ear-/headphones output voltage and therefore the sound pressure level.



This symbol of the crossed out wheeled bin indicates that the product (electrical, electronic equipment, and mercury-containing button cell battery) should not be placed in municipal waste. Please check local regulations for disposal of electronic products.

**AEEE yönetmeliğine uygundur**

## Care & Cleaning

- Before you lift or reposition your monitor, it is better to disconnect the cables and power cord. Follow the correct lifting techniques when positioning the monitor. When lifting or carrying the monitor, grasp the edges of the monitor. Do not lift the display by the stand or the cord.
- Cleaning. Turn your monitor off and unplug the power cord. Clean the monitor surface with a lint-free, non-abrasive cloth. Stubborn stains may be removed with a cloth dampened with mild cleaner.
- Avoid using a cleaner containing alcohol or acetone. Use a cleaner intended for use with the OLED. Never spray cleaner directly on the screen, as it may drip inside the monitor and cause an electric shock.

### The following symptoms are normal with the monitor:

- You may find slightly uneven brightness on the screen depending on the desktop pattern you use.
- When the same image is displayed for hours, an afterimage of the previous screen may remain after switching the image. The screen will recover slowly or you can turn off the Power Switch for hours.
- When the screen becomes black or flashes, or cannot work anymore, contact your dealer or service center to fix it. Do not repair the screen by yourself!

### Conventions used in this guide



**WARNING:** Information to prevent injury to yourself when trying to complete a task.



**CAUTION:** Information to prevent damage to the components when trying to complete a task.



**IMPORTANT:** Information that you **MUST** follow to complete a task.



**NOTE:** Tips and additional information to aid in completing a task.

## Where to find more information

Refer to the following sources for additional information and for product and software updates.

### 1. **ASUS websites**

The ASUS websites worldwide provide updated information on ASUS hardware and software products. Refer to <http://www.asus.com>

### 2. **Optional documentation**

Your product package may include optional documentation that may have been added by your dealer. These documents are not part of the standard package.

## Takeback Services

ASUS recycling and takeback programs come from our commitment to the highest standards for protecting our environment. We believe in providing solutions for our customers to be able to responsibly recycle our products, batteries and other components as well as the packaging materials.

Please go to <http://csr.asus.com/english/Takeback.htm> for detail recycling information in different region.

## Product information for EU energy label







## 1.1 Welcome!

Thank you for purchasing the ASUS® OLED monitor!

The latest widescreen OLED monitor from ASUS provides a crisper, broader, and brighter display, plus a host of features that enhance your viewing experience.

With these features, you can enjoy the convenience and delightful visual experience that the monitor brings to you!

## 1.2 Package contents

Check your package for the following items:

- ✓ OLED monitor
- ✓ Stand arm
- ✓ Stand base
- ✓ Calibration report
- ✓ Quick start guide
- ✓ Warranty card
- ✓ ProArt welcome card
- ✓ Power cord
- ✓ HDMI cable
- ✓ DisplayPort cable
- ✓ USB Type-C cable



---





If any of the above items is damaged or missing, contact your retailer immediately.

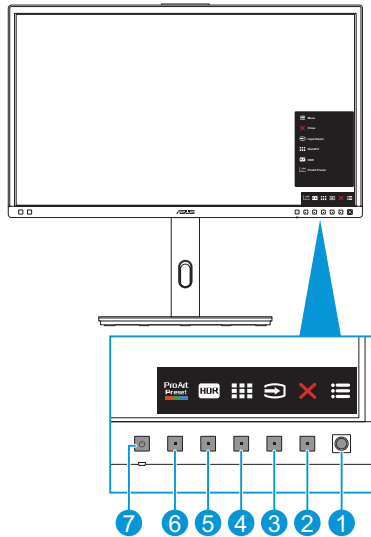

---

# 1.3 Monitor introduction

## 1.3.1 Front view



1.  Menu (5-way) button:
  - Enter the OSD menu.
  - Enact the selected OSD menu items.
  - Increase/Decrease values or move your selection up/down/left/right.
2.  Close button:
  - Exit the OSD menu.
  - Toggle the Key Lock function between on and off with a long press for 5 seconds.
3.  Input Select button:
  - Smart switch to the next existed input source.
4.  QuickFit Plus Button:
  - This is a hotkey to activate the QuickFit Plus function designed for alignment.
  - The QuickFit Plus function contains 4 types of alignment patterns. (Please refer to 1.3.3 QuickFit Plus Function).

5.  Shortcut 1
  - Default: HDR hotkey
  - To change the hotkey function, go to the Shortcut > Shortcut 1 menu.
6.  Shortcut 2
  - Default: ProArt Preset hotkey
  - To change the hotkey function, go to the Shortcut > Shortcut 2 menu.
7.  Power Button/Power Indicator:
  - Turn the monitor on/off.
  - The color definition of the power indicator is as the below table.

Status	Description
White	ON
Amber	Standby mode
OFF	OFF

### 1.3.2 Back view

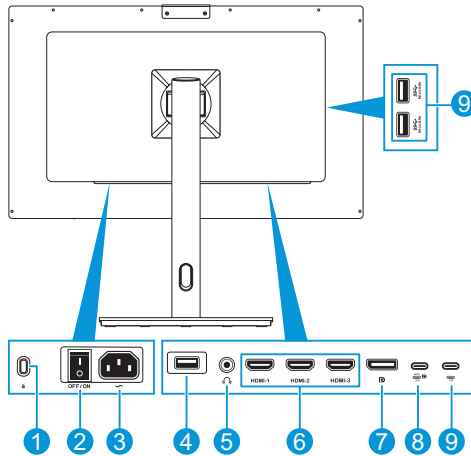



1. **Kensington lock slot:** This port connects a lock-and-cable apparatus for security purposes.
2. **Power switch:** Press the switch to turn on/off power.
3. **AC-IN port:** This port connects the power cord.
4. **USB Type-A (Service):** This port is for upgrading the firmware.
5. **Earphone jack:** This port connects to an earphone.
6. **HDMI ports:** These ports are for connection with an HDMI compatible device.
7. **DisplayPort in:** This port is for connection with a DisplayPort compatible device.
8. **USB 3.2 Type-C:** This port is for connection with a DisplayPort/USB Type-C compatible device. This port is also for connection with a USB upstream cable, which supports USB power and data delivery.



This monitor is Super-Speed USB 3.2 Gen 2 compatible (10 Gbps). The port offers 5V/3A, 9V/3A, 12V/3A, 15V/3A, and 20V/4A power delivery.

9. **USB 3.2 Gen 2 Type-C, Type-A (SuperSpeed USB 10Gbps):** These ports are for connection with USB devices, such as USB keyboard/mouse, USB flash drive, etc.

### 1.3.3 QuickFit Plus Function

The QuickFit Plus function contains 4 types of patterns: (1) Safe Area (2) Center Marker (3) Customization (4) Ruler. To activate the patterns, press the  QuickFit Plus button. Use the  Menu (5-way) button to select a desired pattern. You can move the button up/down/left/right to change the pattern's position if needed.

Note that only **Customization** pattern can be adjusted its frame size according to your need, but may have limited range for moving left/right/up/down.

#### 1. Safe Area

Facilitates designers and users to organize content and layout on one page and achieve a consistent look and feel.

The selections are:

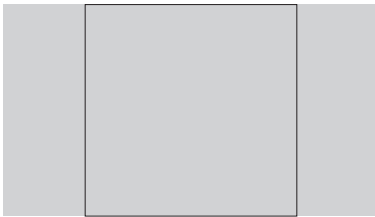

1:1



Action Safe

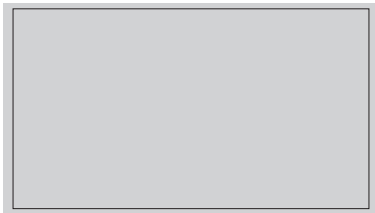

Title Safe

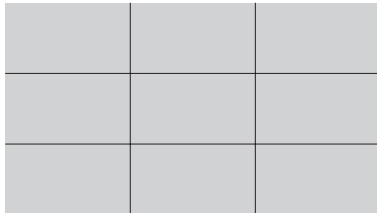

3 x 3

## 2. Center Marker

Selects the center marker type.

The selections are:

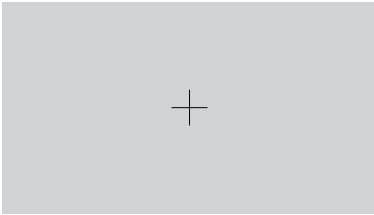

Type 1

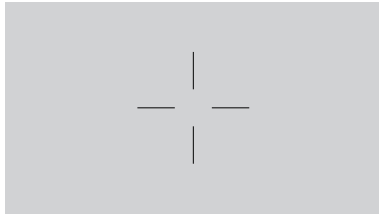

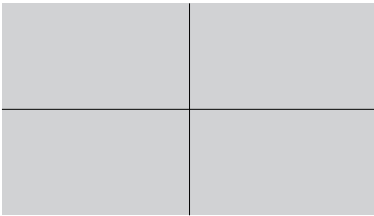

Type 2



Type 3

## 3. Customization

You can decide the frame size by moving the  Menu (5-way) button up/down/left/right. You can press the  Menu (5-way) button for longer than 3 seconds to switch the measurements between millimeter and inch.

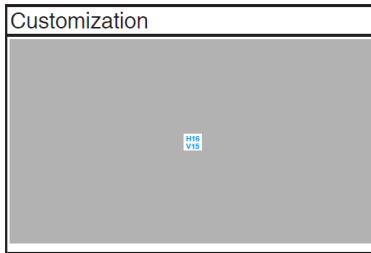

#### 4. Ruler

This pattern presents physical ruler on top and left side. You can press the  Menu (5-way) button for longer than 3 seconds to switch the measurements between metric and imperial.

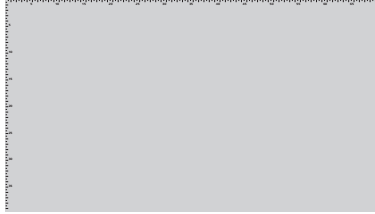

### 1.3.4 Other Function(s)

#### 1. HDR

The monitor supports HDR format. When detecting HDR content, an “HDR ON” message will pop up and display the Information page.



---

HDR content is not supported when the PIP/PBP mode is on.

---

## 2.1 Attaching the stand (arm/base)

To assemble the stand:

1. Carefully take the monitor out of the box. Hold the monitor firmly and do not press on the panel screen when lifting to avoid any accidental damage (Figure 1).
2. Have the front of the monitor face down on a table.
3. Align and slide the guide tabs on the stand arm into the mounting slots on the rear of the monitor. Then place the mounting plate onto its compartment (Figure 2).
4. Install the stand base to the stand arm (Figure 3).
5. Lift the screw ring and turn it clockwise to secure the stand base in place (Figure 4).

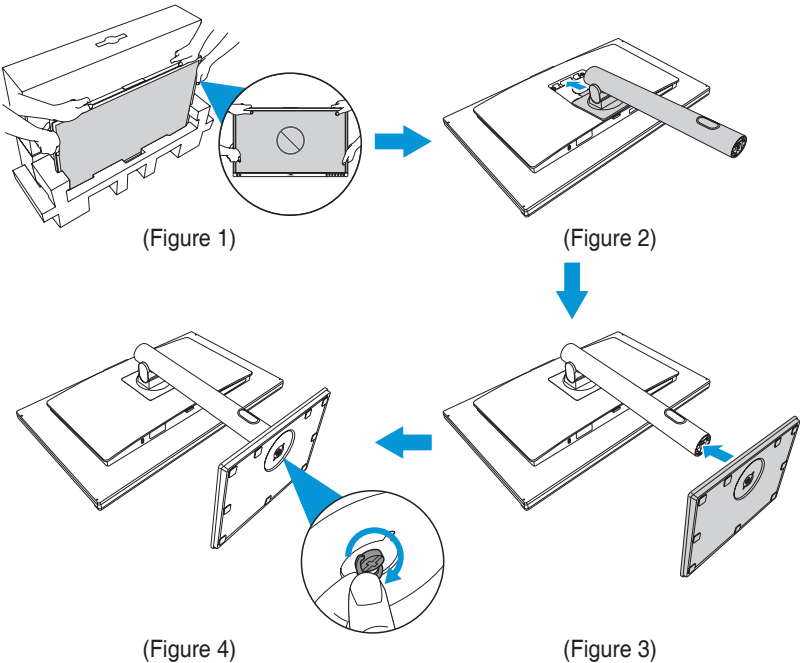





- We recommend that you cover the table surface with soft cloth to prevent damage to the monitor.
- When the panel screen is facing down, be careful not to damage the  Menu (5-way) button.

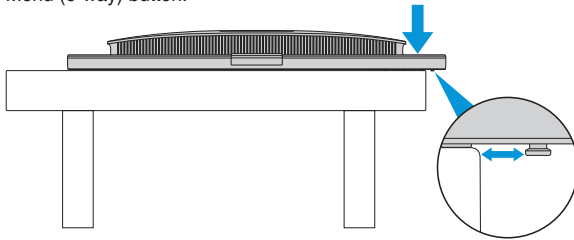



## 2.2 Detaching the stand (for VESA wall mount)

The detachable stand of this monitor is specially designed for VESA wall mount.

To detach the stand:

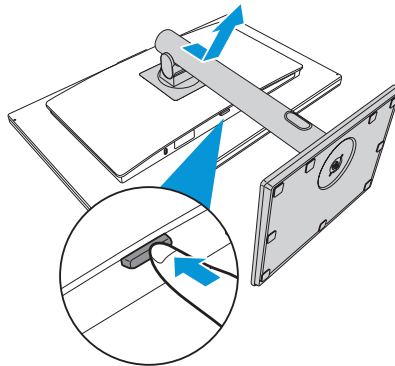
1. Have the front of the monitor face down on a table.
2. Press the latch to release the mounting plate of the stand arm. Then remove the stand.



- We recommend that you cover the table surface with soft cloth to prevent damage to the monitor.
- When the panel screen is facing down, be careful not to damage the  Menu (5-way) button.

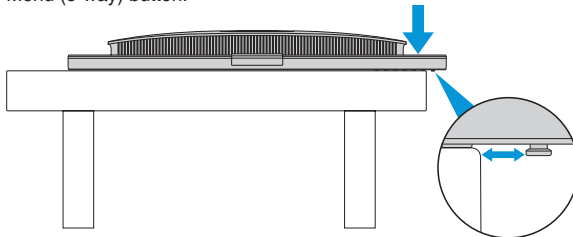

- The VESA wall mount kit (100 x 100 mm) is purchased separately.
- Use only the UL Listed Wall Mount Bracket with minimum weight/load 22.7kg (Screw size: M4 x 10 mm).

## 2.3 Adjusting the monitor

- For optimal viewing, we recommend that you look at the full face of the monitor, then adjust the monitor to the angle that is most comfortable for you.
- Hold the stand to prevent the monitor from falling when you change its angle.
- You can adjust the monitor's angle from  $-5^{\circ}$ ~ $+23^{\circ}$ , and it allows  $30^{\circ}$  swivel adjustment from either left or right. You can also adjust the monitor's height within 130 mm.

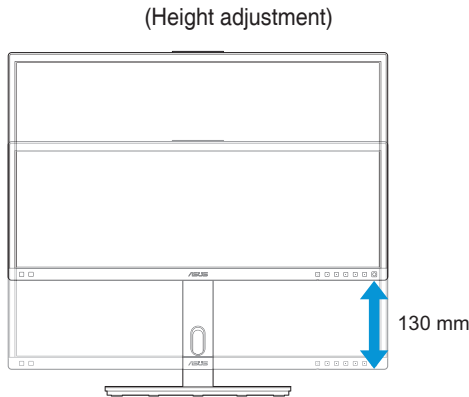
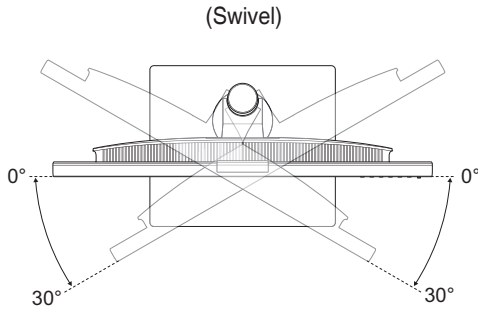
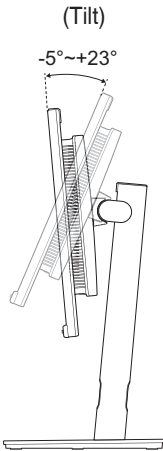

## Pivoting the monitor

1. Lift the monitor to the highest position.
2. Tilt the monitor to its maximum angle.
3. Pivot the monitor to the angle you need.

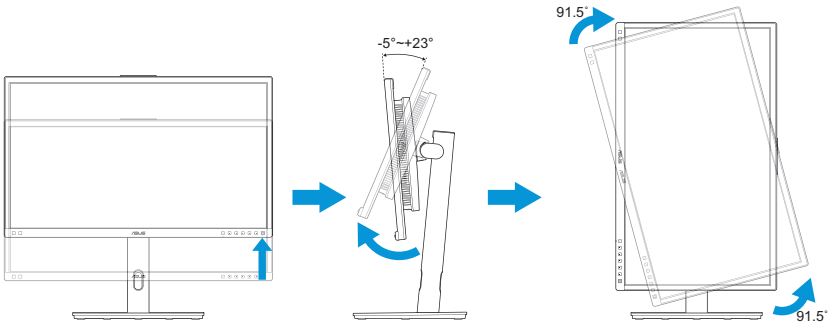

It is normal that the monitor slightly shakes while you adjust the viewing angle.

4. The OSD menu item will automatically rotate when the monitor rotates.

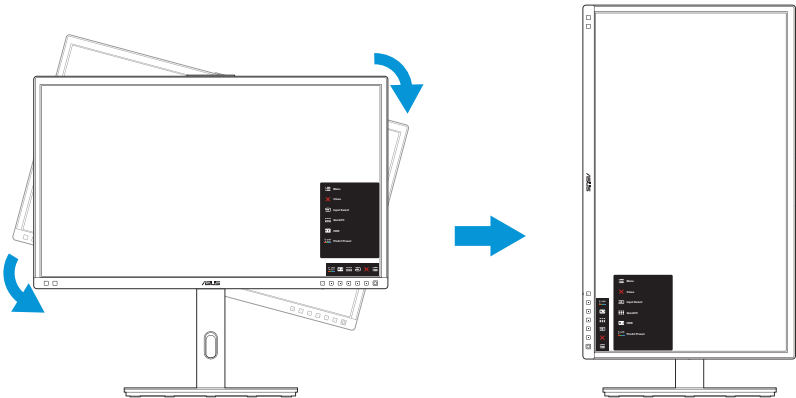

## 2.4 Connecting the cables

Connect the cables according to the following instructions:

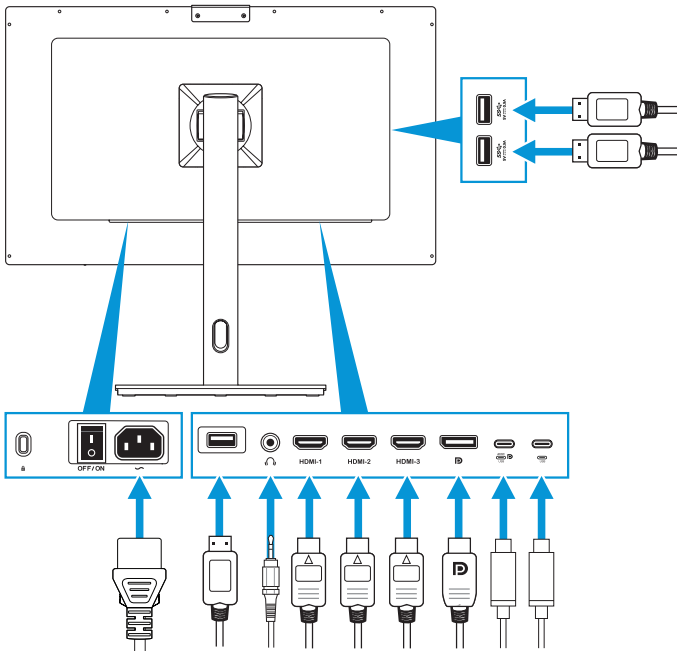

- **To connect the power cord:** Connect one end of the power cord securely to the monitor's AC input port, the other end to a power outlet.
- **To connect the HDMI/DisplayPort/USB Type-C/USB Type-A cable:**
  - a. Plug one end of the HDMI/DisplayPort/USB Type-C/USB Type-A cable to the monitor's HDMI/DisplayPort/USB Type-C/USB Type-A jack.
  - b. Connect the other end of the HDMI/DisplayPort/USB Type-C\* cable to your device's HDMI/DisplayPort/USB Type-C jack.



It is suggested to use USB certified Type-C 4K/ support 4A (or up to 4A) cable. If the signal source supports DP Alt mode, all video, audio and data signal can be transmitted.

- **To use the earphone:** Connect the end with plug type to the monitor's earphone jack when an HDMI/DisplayPort/USB Type-C signal is fed.

- **To use the USB upstream/downstream function:**

- » Upstream: Use an USB Type-C cable and plug one end of the Type-C connector to the monitor's USB 3.2 Type-C port as upstream and the other end to your computer's USB Type-C port. Or use an USB Type-C to Type-A cable, plug the Type-C connector to the monitor's USB 3.2 Type-C port as upstream and the Type-A connector to your computer's USB Type-A port. Make sure your computer is installed with the latest Windows 10/11 operating system. That will enable the USB ports on the monitor to work.
- » Downstream: Use an USB cable to connect your device with the monitor's USB Type-A port.



---

When these cables are connected, you can choose the desired signal from the Input Select item in the OSD menu.

---

## 2.5 Turning on the monitor



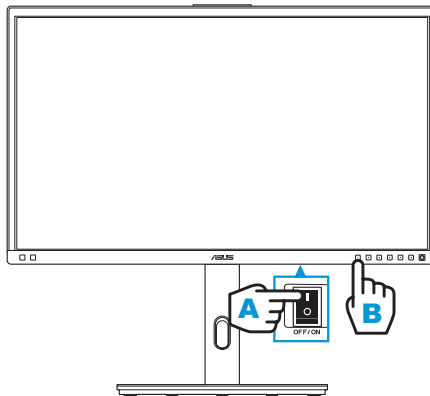



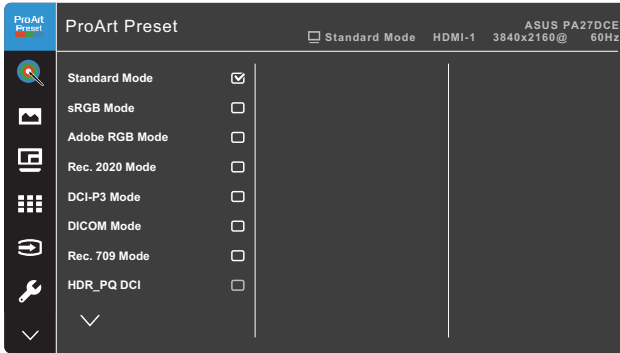

Set the AC switch to ON position (A), and then press the  button (B). See page 1-3 for the location of the Power button. The power indicator lights up in white to show that the monitor is ON.



## 3.1 OSD (On-Screen Display) menu

### 3.1.1 How to reconfigure



1. Press the  Menu (5-way) button to activate the OSD menu.
2. Move the  Menu (5-way) button up/down/left/right to navigate through the functions. Highlight the desired function and press the  Menu (5-way) button to activate it. If the function selected has a sub-menu, move the  Menu (5-way) button up/down to navigate through the sub-menu functions. Highlight the desired sub-menu function and press the  Menu (5-way) button or move the  Menu (5-way) button to activate it.
3. Move the  Menu (5-way) button up/down to change the settings of the selected function.
4. To exit and save the OSD menu, press the  Close button or move the  Menu (5-way) left repeatedly until the OSD menu disappears. To adjust other functions, repeat steps 1-3.

### 3.1.2 OSD function introduction

#### 1. ProArt Preset

This function contains 13 sub-functions you can select for your preference. Each mode has the Reset selection, allowing you to maintain your setting or return to the preset mode.



- **Standard Mode:** Best choice for document editing.
- **sRGB Mode:** Compatible with sRGB color space, sRGB is the best choice for web browsing.
- **Adobe RGB Mode:** Compatible with Adobe RGB color space.
- **Rec. 2020 Mode:** Compatible with Rec. 2020 color space.
- **DCI-P3 Mode:** Compatible with DCI-P3 color space.
- **DICOM Mode:** Compliant with DICOM standard, best choice for medical image checking.
- **Rec. 709 Mode:** Compatible with Rec.709 color space.
- **HDR\_PQ DCI:** Presents ST2084 with DCI-P3 color gamut and D65 white point.
  - » PQ Optimized: Delivers the optimized HDR performance of this display with as much accuracy as with ST2084 in terms of display luminance capability.
  - » PQ Clip: Preserves PQ curve till displaying maximum luminance with accuracy. ST2084 code value with higher than display maximum will be mapped to the maximum luminance.
  - » PQ Basic: Presents HDR performance of general HDR supported displays.



- **HDR\_PQ Rec2020:** Presents ST2084 with Rec.2020 color gamut and D65 white point.
  - » PQ Optimized: Delivers the optimized HDR performance of this display with as much accuracy as with ST2084 in terms of display luminance capability.
  - » PQ Clip: Preserves PQ curve till displaying maximum luminance with accuracy. ST2084 code value with higher than display maximum will be mapped to the maximum luminance.
  - » PQ Basic: Presents HDR performance of general HDR supported displays.
- **HDR\_HLG BT2100:** Compliant with BT2100.
- **HDR\_HLG DCI:** Compliant with DCI-P3.
- **User Mode 1/User Mode 2:** You can save one or two ProArt Calibration profiles as User Mode 1/User Mode 2 after executing ProArt Calibration and then have quick access here.



Please apply the following settings while performing ProArt color calibration:

- Set output dynamic to full range.
- Set output color format to RGB.
- Set output color depth to 8 bit.

Below tables show the default configurations for each ProArt Preset mode:

Function	Standard	sRGB	AdobeRGB	Rec. 709
Color Temp.	6500K	Fixed (6500K)	Fixed (6500K)	6500K
Brightness	50	Fixed 80nits	160nits	100nits
Contrast	80	80	80	80
Sharpness	Enable (0)	Enable (0)	Enable (0)	Enable (0)
Saturation	Middle (50)	Fixed	Middle (50)	Middle (50)
Hue	Middle (50)	Fixed	Middle (50)	Middle (50)
ProArt Palette/ Color	Enable (default)	Fixed	Enable (default)	Enable (default)
Black Level	Enable (default)	Enable (default)	Enable (default)	Enable (default)
Gamma	Enable (2.2)	Fixed (2.2)	Fixed (2.2)	Enable (2.4)
Light Effect	Enable (default)	Fixed	Enable (default)	Enable (default)
Adaptive Color	Enable (default)	Fixed	Fixed	Enable (default)
Uniform Brightness	Enable (default: Off)	Fixed (On)	Enable (default: On)	Enable (default: On)

Function	DCI-P3	Rec. 2020	DICOM	HDR_PQ DCI
Color Temp.	P3-Theater	6500K	6500K	Fixed (6500K)
Brightness	48nits	100nits	80	200nits/Max
Contrast	80	80	80	Disable
Sharpness	Enable (0)	Enable (0)	Enable (0)	Enable (0)
Saturation	Middle (50)	Middle (50)	Middle (50)	Fixed
Hue	Middle (50)	Middle (50)	Middle (50)	Fixed
ProArt Palette/ Color	Enable (default)	Enable (default)	Enable (default)	Enable (RGB Gain only)
Black Level	Enable (default)	Enable (default)	Enable (default)	Enable (default)
Gamma	Enable (2.2/2.6 only)	Enable (2.4)	Fixed	Fixed
Light Effect	Enable (default)	Enable (default)	Enable (default)	Fixed
Adaptive Color	Enable (default)	Enable (default)	Enable (default)	Fixed
UniformBrightness	Enable (default: On)	Enable (default: On)	Enable (default: On)	Enable (default: Off)

Function	HDR_PQ Rec2020	HDR_HLG BT2100	HDR_HLG DCI
Color Temp.	Fixed (6500K)	Fixed (6500K)	Fixed (6500K)
Brightness	200nits/Max	200nits/Max	200nits/Max
Contrast	Fixed	Fixed	Fixed
Sharpness	Enable (0)	Enable (0)	Enable (0)
Saturation	Fixed	Fixed	Fixed
Hue	Fixed	Fixed	Fixed
ProArt Palette/ Color	Enable (RGB Gain only)	Enable (RGB Gain only)	Enable (RGB Gain only)
Black Level	Enable (default)	Enable (default)	Enable (default)
Gamma	Fixed	Fixed	Fixed
Light Effect	Fixed	Fixed	Fixed
Adaptive Color	Fixed	Fixed	Fixed
UniformBrightness	Enable (default: Off)	Enable (default: On)	Enable (default: On)

Function	User Mode 1	User Mode 2
Color Temp.	Fixed (6500K)	Fixed (6500K)
Brightness	50	50
Contrast	80	80
Sharpness	Enable (0)	Enable (0)
Saturation	Middle (50)	Middle (50)
Hue	Middle (50)	Middle (50)
ProArt Palette/ Color	Enable (RGB Gain only)	Enable (RGB Gain only)
Black Level	Enable (default)	Enable (default)
Gamma	Fixed (2.2)	Fixed (2.2)
Light Effect	Fixed	Fixed
Adaptive Color	Fixed	Fixed
Uniform Brightness	Fixed (default: On)	Fixed (default: On)

Select Standard Mode to support Energy Star energy-saving

This product complied with ENERGY STAR.

The default as shipped displays configuration and settings are compliance with ENERGY STAR, and are recommended by the ENERGY STAR program for optimal energy savings.

Note: enabling certain optical features and functionalities (e.g., instant-on), may increase energy consumption beyond the limits required for ENERGY STAR certification, as applicable.

## 2. ProArt Palette

Set a desired color setting from this menu.



To activate this function, you need to disable the Ambient Effect function.

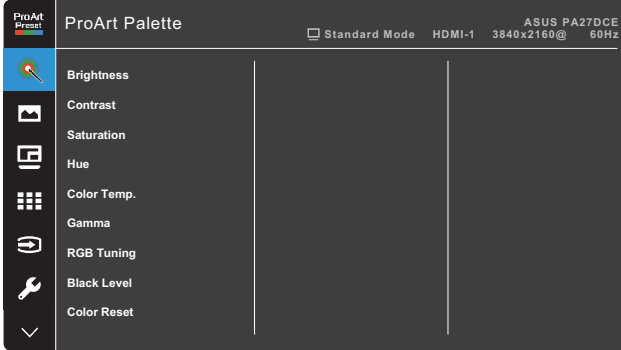

- **Brightness:** The adjusting range is from 0 to 100.



When the HDR function is enabled, the maximum brightness level is automatically set to 350nits as default.

- **Contrast:** The adjusting range is from 0 to 100.
- **Saturation:** The adjusting range is from 0 to 100.
- **Hue:** Shifts the image color between green and purple.
- **Color Temp.:** Contains 5 modes including 9300K, 6500K, 5500K, 5000K, and P3-Theater.



When the ProArt Preset setting is set to DCI-P3 Mode, only 6500K and P3-Theater options are available.

- **Gamma:** Allows you to set the color mode to 1.8, 2.0, 2.2, 2.4, or 2.6.
- **RGB Tuning:** Configures the color settings.
  - » Gain: Adjusts the gain levels for the red, green, or blue color.
  - » Offset: Adjusts the black level offset values for the red, green, or blue color.
- **Black Level:** Adjusts the initialized 1st signal level of darkest gray level.

- **Color Reset:** Resets the color related settings.
  - » Current mode color reset:  
Resets the color settings of the current color mode to the factory default value.
  - » All modes color reset:  
Resets the color settings of all color modes to the factory default value.

### 3. Image

Set the image related setting from this menu.

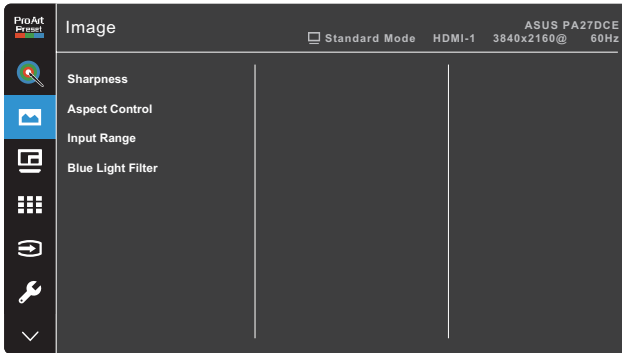

- **Sharpness:** The adjusting range is from 0 to 100.
- **Aspect Control:** Adjusts the aspect ratio to Full, 4:3, 1:1, or OverScan.



- To activate this function, you need to do the following: turn off the PBP mode.
- 4:3 is only available when input source is in 4:3 format. OverScan is only available for the HDMI input source.

- **Input Range:** Adjusts the input range to Auto, Full, Limited 16-235, or Limited 16-254.
- **Blue Light Filter:** Adjusts the blue light filter level.
  - » Level 0: No change.
  - » Level 1~4: The higher the level, the less blue light is scattered. When Blue Light Filter is activated, the default settings of Standard Mode will be automatically imported. Between Level 1 to Level 3, the Brightness function is user-configurable. Level 4 is optimized setting. It is compliance with TUV Low Blue Light Certification. The Brightness function is not user-configurable.



---

Please refer to the following to alleviate eye strains:

- Users should take some time away from the display if working for long hours. It is advised to take short breaks (at least 5 mins) after around 1 hour of continuous working at the computer. Taking short and frequent breaks is more effective than a single longer break.
  - To minimize eye strain and dryness in your eyes, users should rest the eye periodically by focusing on objects that are far away.
  - Eye exercises can help to reduce eye strain. Repeat these exercises often. If eye strain continues please consult a physician. Eye exercises: (1) Repeating look up and down (2) Slowly roll your eyes (3) Move your eyes diagonal.
  - High energy blue light may lead to eye strain and AMD (Age-Related Macular Degeneration). Blue light Filter to reduce 70% (max.) harmful blue light to avoiding CVS (Computer Vision Syndrome).
-

#### 4. PIP/PBP Setting

The PIP/PBP Setting allows you to open up another sub-window connected from another video source besides the main-window from your original video source. By activating this function, the monitor displays up to 2 pictures from different video sources.



To activate this function, you need to disable the HDR function.

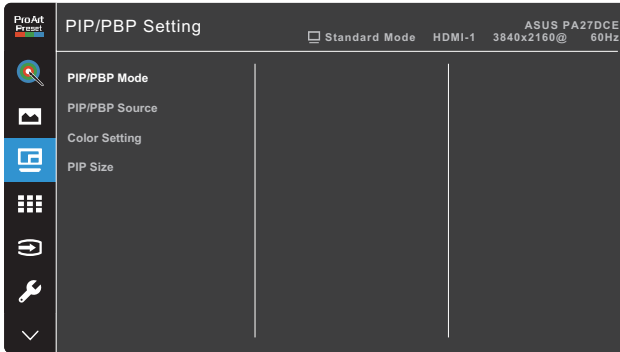

- **PIP/PBP Mode:** Selects PIP, PBP, PBP x 3, or PBP x 4 function, or turn it off.
- **PIP/PBP Source:** Selects the video input source between HDMI-1, HDMI-2, HDMI-3, DisplayPort, and USB Type-C. The table below shows the input source combinations.

Sub-window	Main-window				
	HDMI-1	HDMI-2	HDMI-3	DisplayPort	USB Type-C
HDMI-1	Yes	Yes	Yes	Yes	Yes
HDMI-2	Yes	Yes	Yes	Yes	Yes
HDMI-3	Yes	Yes	Yes	Yes	Yes
DisplayPort	Yes	Yes	Yes	Yes	Yes
USB Type-C	Yes	Yes	Yes	Yes	Yes

- **Color Setting:** Selects an individual ProArt Preset Mode for the selected PIP/PBP source. (Up to 2 ProArt Preset modes can be chosen)
- **PIP Size:** Adjusts the PIP size to Small, Middle, or Large. (Only available for the PIP mode)



## 5. QuickFit Plus

Allows users to have a preview of the document or photo layout directly on the screen without printing the test copies.

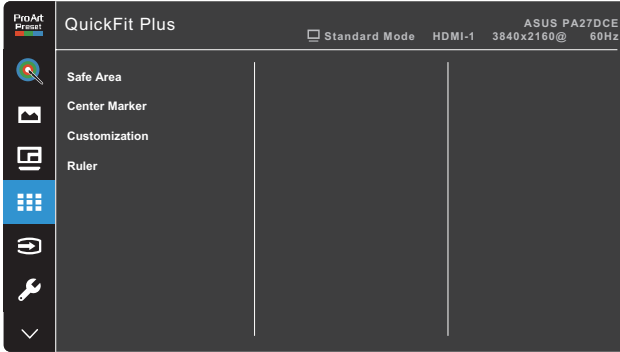

To activate this function, you need to disable the PIP/PBP mode.



- **Safe Area:** Facilitates designers and users to organize content and layout on one page and achieve a consistent look and feel. The selections are: 1:1, Action Safe, Title Safe, or 3 x 3.
- **Center Marker:** Selects the center marker type. The selections are: Type 1, Type 2, or Type 3.
- **Customization:** You can decide the frame size by moving the  Menu (5-way) button up/down/left/right. You can press the  Menu (5-way) button for longer than 3 seconds to switch the measurements between millimeter and inch.
- **Ruler:** This pattern presents physical ruler on the top and left sides. You can press the  Menu (5-way) button for longer than 3 seconds to switch the measurements between metric and imperial.



## 6. Input Select

In this function, you can select your desired input source.



## 7. System Setup

Allows you to adjust the system.

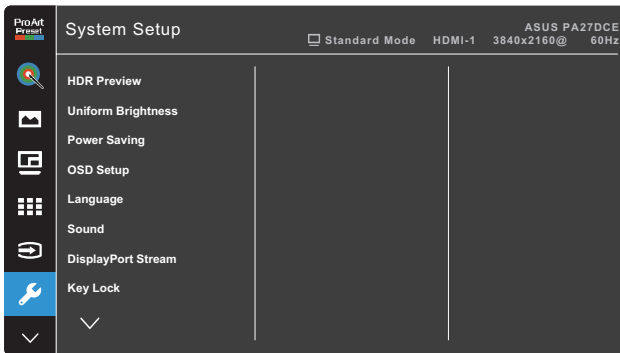



- **HDR Preview:** Allows you to preview non-HDR content performance with HDR10 and HLG mapping. While HDR Preview function is on, only HDR\_PQ DCI, HDR\_PQ Rec2020, HDR\_HLG BT2100, and HDR\_HLG DCI options can be chosen.



To activate this function, you need to disable the PIP/PBP mode.

- **Uniform Brightness:** If enabled, the maximum brightness is approximately 200 nits.

- **Power Saving:** Specifies the power saving setting.
    - » Normal Level: Allows the USB downstream ports/USB Type-C ports to charge external devices when the monitor enters power saving mode.
    - » Deep Level: Does not allow all ports to charge external devices and keeps USB Type-C and USB signals from being automatically detected when the monitor enters power saving mode.
  - **OSD Setup:** Configures the OSD menu settings.
    - » OSD Timeout: Adjusts the OSD timeout from 10 to 120 seconds.
    - » DDC/CI: Enables or disables the DDC/CI function.
    - » Transparency: Adjusts the OSD background from opaque to transparent.
    - » Auto Rotation: Enables or disables the automatic OSD rotation function.
  - **Language:** Selects the OSD menu language.
  - **Sound:** Configures the sound settings.
    - » Volume: Adjusts the output volume level.
    - » Mute: Enables or disables the mute function.
    - » Source: Specifies the monitor sound comes from which source. (Only available for the PIP/PBP mode)
  - **DisplayPort Stream:** Compatibility with graphic card. Select DisplayPort 1.2, DisplayPort 1.4 or DisplayPort 1.4 + USB 3.2 by graphic card DP version.
    - » DisplayPort 1.4: While connecting to USB-C, the USB data transfer rate according to the 2.0 specification can output the maximum resolution of 4K2K 60Hz.
    - » DisplayPort 1.4 + USB 3.2: While connecting to USB-C, the USB data transfer rate according to the 3.2 specification can only output the maximum resolution of 4K2K 30Hz.
  - **Key Lock:** Selects “On” to disable all function keys. To cancel the Key Lock function, press the  Close button for more than five seconds. See page 1-2 for the location of the  Close button.
  - **Power Indicator:** Turns the power LED indicator on/off.
  - **Ambient Effect:** Configures the ambient effect settings.
    - » Light Effect: Adjusts the brightness level adaptively.
- 
- 

This function will be disabled if the HDR function is enabled and the ProArt Preset setting is set to Standard, Adobe RGB, Rec 709, DCI-P3, Rec 2020, or DICOM.
- 
- » Adaptive Color: Adjusts the color temperature adaptively.



---

This function will be disabled if the HDR function is enabled and the ProArt Preset setting is set to Standard, Rec 709, DCI-P3, Rec 2020, or DICOM.

---

- **Proximity Sensor:** If the function is enabled and the system does not detect the presence of object within 30cm-1.5m over the preset time, the system will automatically decrease brightness periodically.



- Recovery time would be within 2 seconds.
  - Detectable ability and distance are different according to the object and environment.
  - Please avoid placing objects in front of the sensor (between 30 cm and 1.5 m), as it will cause the function of the sensor to fail (misjudging that someone is ahead).
- 

- **Screen Protection:** Ensure the life cycle of panel by decreasing brightness gradually.



---

This function will be disabled if the ProArt Preset setting is set to HDR\_PQ DCI, HDR\_PQ Rec2020, HDR\_HLG BT2100, or HDR\_HLG DCI.

---

- **Information:** Shows the monitor information.
- **All Reset:** Selects “Yes” to revert all settings to the factory default mode.

## 8. Shortcut

Defines the functions for Shortcut 1 and 2 buttons.

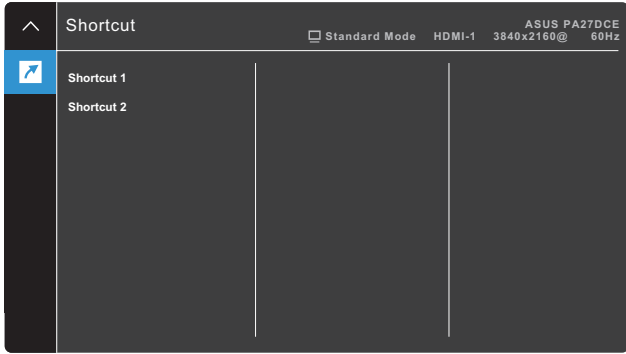

- **Shortcut 1/Shortcut 2:** Selects a function for Shortcut 1 and 2 buttons.



When a certain function is selected or activated, your shortcut key may not support. Available function choices for shortcut: Blue Light Filter, Brightness, ProArt Preset, HDR, PIP/PBP Setting, Color Temp., Volume, User Mode 1, User Mode 2.

## 3.2 Specifications Summary

Panel Type	OLED PANEL
Panel Size	26.9" wide screen
Max. Resolution	3840 x 2160
Pixel Pitch	0.15525 mm
Brightness	200 cd/m <sup>2</sup> (Typ.), 350 cd/m <sup>2</sup> (Peak)
Contrast Ratio	1,000,000:1 (max.)
Viewing Angle (H/V) CR>10	178° (H) / 178° (V)
Display Colors	1.07 Billion (10 bit)
Color Gamut	Adobe RGB 99%, DCI-P3 99%, sRGB 100%
Response Time	0.1ms
ProArt Preset Selection	13 color preset modes (2 user modes included)
Color Temperature Selection	5 color temperatures
Digital Input	HDMI 2.0, DisplayPort 1.4, USB Type-C
Earphone Jack	Yes (3.5mm)
USB 3.2 port	Upstream x 1, Downstream x 3 (USB 3.2 Gen 2)
Color	Black
Power LED	White (On)/Amber (Standby)
Tilt	+23° ~ -5°
Swivel	+30° ~ -30°
Pivot	+91.5° ~ -91.5°
Height Adjustment	130mm
Kensington lock	Yes
AC input voltage	AC: 100~240V
Power consumption	Power On: < 32 W**(Typ.), Standby: < 0.5W, Power Off: 0 W(Switch off)
Temperature (Operating)	0°C ~ 40°C
Temperature (Non-operating)	-20°C ~ +60°C
Dimension (W x H x D)	626.7mm x 376.2mm x 66.9mm (monitor only) 626.7mm x 569.6mm x 265mm (with stand, highest) 626.7mm x 439.6mm x 265mm (with stand, lowest) 855mm x 595mm x 295mm (package)
Weight (Esti.)	5.9 kg (monitor only) 9.4 kg (with stand) 15 kg (Gross)

Multi-languages	27 Languages (English, Simplified Chinese, Traditional Chinese, Japanese, Russian, Spanish, Italian, German, French, Dutch, Portuguese, Czech, Croatia, Romania, Turkish, Arabic, Danish, Finnish, Greek, Hungarian, Slovak, Slovenian, Swedish, Polish, Korean, Persian, Ukraine)
Accessories	Quick start guide, Warranty card, Power cord, HDMI cable, USB Type-C cable, DisplayPort cable, Calibration report, Stand arm, Stand base, ProArt welcome card
Compliance and Standards	cTUVus(62368-1), FCC(class B), ICES-3, CB, CE, ISO 9241-307, CCC BSMI, RCM, MEPS, VCCI, PSE, KC e-Standby, PSB, Energy Star 8.0, CEC, Windows 10/11 WHQL (64bits), TUV Low Blue Light & Flicker Free, HDMI, VESA DP/USB

**\*Specifications are subject to change without notice.**

**\*\*Measuring a screen brightness of 200 nits without audio/USB/Card reader connection.**

**\*\*\*Requires Mac OS 11.6.x.**

### 3.3 Outline dimensions

[Monitor]

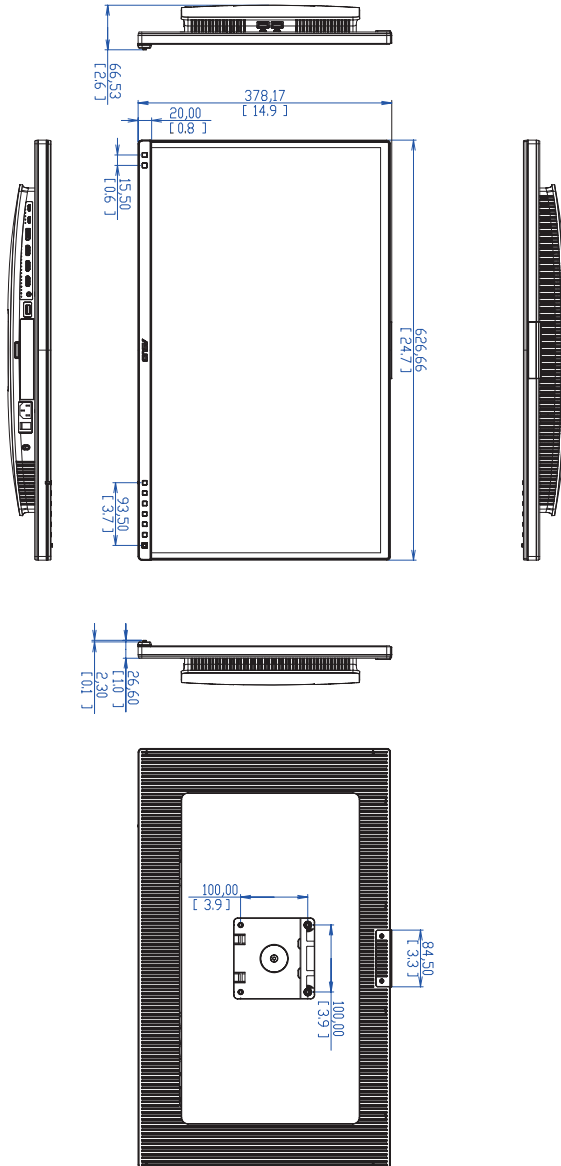

[Monitor with stand]

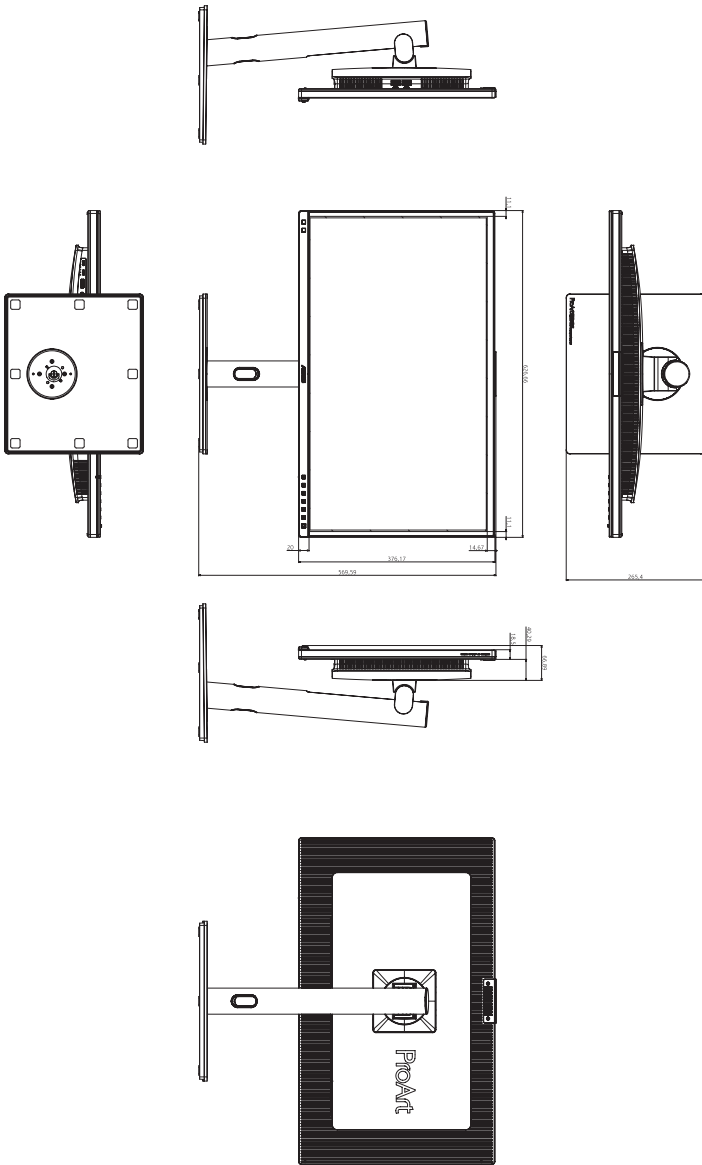



## 3.4 Troubleshooting (FAQ)

Problem	Possible Solution
Power LED is not ON	<ul style="list-style-type: none"><li>• Press the  button to check if the monitor is in the ON mode.</li><li>• Check if the power cable is properly connected to the monitor and the power outlet.</li><li>• Check if the AC switch is set to ON.</li></ul>
The power LED lights amber and there is no screen image	<ul style="list-style-type: none"><li>• Check if the monitor and the computer are in the ON mode.</li><li>• Make sure the signal cable is properly connected the monitor and the computer.</li><li>• Inspect the signal cable and make sure none of the pins are bent.</li><li>• Connect the computer with another available monitor to check if the computer is properly working.</li></ul>
Screen image is too light or dark	<ul style="list-style-type: none"><li>• Adjust the Contrast and Brightness settings via OSD.</li></ul>
Screen image bounces or a wave pattern is present in the image	<ul style="list-style-type: none"><li>• Make sure the signal cable is properly connected to the monitor and the computer.</li></ul>
Screen image has color defects (white does not look white)	<ul style="list-style-type: none"><li>• Inspect the signal cable and make sure that none of the pins are bent.</li><li>• Perform All Reset via OSD.</li><li>• Adjust the RGB Tuning settings or select the Color Temperature (Color Temp.) via OSD.</li></ul>
No sound or sound is low	<ul style="list-style-type: none"><li>• Ensure that the HDMI/DisplayPort cable is properly connected to the monitor and the computer.</li><li>• Adjust the volume settings of both your monitor and HDMI/DisplayPort device.</li><li>• Ensure that the computer graphic card driver is properly installed and activated.</li></ul>

## 3.5 Supported operating modes

Resolution	Frequency	Vertical Frequency (Hz)	Horizontal Frequency KHz	Pixel (MHz)
640x480		59.94(N)	31.47(N)	25.18
640x480		72.82(N)	37.87(N)	31.5
640x480		75(N)	37.5(N)	31.5
720x400		70(P)	31.47(N)	28.32
720x480		59.94	31.469	27
720x576		50	31.25	27
800x600		56.25(P)	35.16(P)	36
800x600		60(P)	37.88(P)	40
800x600		72(P)	48.1(P)	50
800x600		75(P)	46.9(P)	49.5
1024x768		60(N)	48.36(N)	65
1024x768		70(N)	56.48(N)	75
1024x768		75(N)	60(N)	78.75
1152x864		75(P/N)	67.5(P/N)	108
1280x720		60	45(N)	74.25
1280x960		60(N)	60(P)	108
1280x1024		60(P)	63.98(P)	108
1280x1024		75(P)	79.98(P)	135
1440x900		60(P)	55.94(N)	106.5
1600x1200		60(P)	75(P)	162
1680x1050		60(P)	65.29(N)	146.25
1920x1080		60(P)	67.5(P)	148.5
1920x1200		59.885(P)	74.556(N)	193.25
1920x2160		60(N)	135(P)	297
2560x1080		60(N)	66(P)	198
2560x1440		59.9(N)	88.7(P)	241.5
3840x2160		23.98(P)	52.593(N)	266.75
3840x2160		25	54.786(N)	278.75
3840x2160		29.97(P)	67.5(N)	297
3840x2160		50(P)	111.174(N)	587
3840x2160(DP)		60(N)	133.3(P)	533.3
3840x2160(HDMI)		60(N)	135(P)	594

“P” / “N” stands for “Positive” / “Negative” polarity of incoming H-sync/V-sync (input timing).  
**When the monitor is operating in the video mode (ie, not displaying data) using the HDMI connector, the following high definition modes shall be supported in addition to standard definition video.**

Resolution	Vertical Frequency (Hz)	Horizontal Frequency (KHz)
1920x1080p	24	27
	25	28.125
	30	33.75
	50	56.25
	60	67.5
1920x1080i	50	28.13
	60	33.75
1440x480p	59.94	31.47
	60	31.5
1440x576p	50	31.25
1280x720p	50	37.5
	60	45

\* Modes not listed in the table may not be supported. For optimal resolution, we recommend that you choose a mode listed in the table above.