

**SAMSUNG**

# User Manual

---

IAB (IAB 146 4K / IAB 110 2K / IAB 146 2K)

---

The colour and the appearance may differ depending on the product, and the content in the manual is subject to change without prior notice to improve the performance.

---

# Table of contents

## Before Using the Product

---

Safety Precautions	4
Safety symbols	4
Electricity and Safety	5
Installation	6
Operation	7
Cleaning	8

## Preparations

---

Checking the Components	9
Ports	10
IAB 146 4K / IAB 146 2K	10
IAB 110 2K	10
Remote Control	11

## Connecting Devices

---

Precautions when handling the cabinets	13
Installing the product	14
Connecting the Power Cable	14

## Player feature

---

Player	15
Viewing content	15
When content is running	16
Available menu	16
File Formats Compatible with Player	17
Schedule	21
Custom Home	22
Clone Product	23

---

ID Settings	24
Device ID	24
Device ID Auto Set	24
PC Connection Cable	24
Video Wall	25
Video Wall	25
Horizontal x Vertical	25
Screen Position	26
Format	26
Network Status	27
Picture Mode	28
On/Off Timer	29
On Timer	29
Off Timer	30
Holiday Management	30
Ticker	31

---

# Table of contents

## Menu

Picture	32
OnScreen Display	37
Sound	38
Network	40
Network Settings (Wired)	41
Network Settings (Wireless)	43
Use WPS	45
System	47
Support	57

## Specifications

General	59
Preset Timing Modes	61

## Appendix

Responsibility for the Pay Service (Cost to Customers)	66
Not a product defect	66
A Product damage caused by customer's fault	66
Others	66
Licence	67





# Chapter 01







## Before Using the Product

### Safety Precautions

The following safety instructions are to ensure your personal safety and prevent property damage. Please read the following to ensure the proper use of the product.

#### Safety symbols









Symbol	Name	Meaning
	Warning	A serious or fatal injury may result if instructions are not followed.
	Caution	Personal injury or damage to properties may result if instructions are not followed.
	Prohibition	Do NOT attempt.
	Instruction	Follow directions.

CAUTION			
RISK OF ELECTRIC SHOCK. DO NOT OPEN.			
CAUTION: TO REDUCE THE RISK OF ELECTRIC SHOCK, DO NOT REMOVE COVER (OR BACK). THERE ARE NO USER SERVICEABLE PARTS INSIDE. REFER ALL SERVICING TO QUALIFIED PERSONNEL.			
	This symbol indicates that high voltage is present inside. It is dangerous to make any kind of contact with any internal part of this product.		AC voltage: Rated voltage marked with this symbol is AC voltage.
	This symbol indicates that this product has included important literature concerning operation and maintenance.		DC voltage: Rated voltage marked with this symbol is DC voltage.
	Class II product: This symbol indicates that a safety connection to electrical earth (ground) is not required. If this symbol is not present on a product with a mains lead, the product MUST have a reliable connection to protective earth (ground).		Caution. Consult instructions for use: This symbol instructs the user to consult the user manual for further safety related information.





---

## Electricity and Safety

### Warning











-  Do not use a damaged power cord or plug, or a loose power socket.  
An electric shock or fire may result.
-  Do not use multiple products with a single power socket.  
Overheated power sockets may cause a fire.
-  Do not touch the power plug with wet hands. Otherwise, an electric shock may result.
-  Do not bend or pull the power cord with force. Be careful not to leave the power cord under a heavy object.  
Damage to the cord may result in a fire or electric shock.
-  Do not place the power cord or product near heat sources.  
A fire or electric shock may result.
-  Insert the power plug all the way in so it is not loose.  
An unsecure connection may cause a fire.
-  Connect the power plug to a grounded power socket (type 1 insulated devices only).  
An electric shock or injury may result.
-  Clean any dust around the pins of the power plug or the power socket with a dry cloth.  
A fire may result.

### Caution

-  Do not disconnect the power cord while the product is being used.  
The product may become damaged by an electric shock.
-  Only use the power cord provided with your product by Samsung. Do not use the power cord with other products.  
A fire or electric shock may result.
-  Keep the power socket where the power cord is connected unobstructed.  
The power cord must be disconnected to cut off power to the product when an issue occurs.
-  Hold the plug when disconnecting the power cord from the power socket.  
An electric shock or fire may result.





# Installation

## Warning

-  DO NOT PLACE CANDLES, INSECT REPELLANTS OR CIGARETTES ON TOP OF THE PRODUCT. DO NOT INSTALL THE PRODUCT NEAR HEAT SOURCES.  
A fire may result.
-  Do not install the product in poorly ventilated spaces such as a bookcase or closet.  
An increased internal temperature may cause a fire.
-  Do not install the product on an unstable or vibrating surface (insecure shelf, sloped surface, etc.)
  - The product may fall and become damaged and/or cause an injury.
  - Using the product in an area with excess vibration may damage the product or cause a fire.
-  Do not expose the product to direct sunlight, heat, or a hot object such as a stove.  
The product lifespan may be reduced or a fire may result.
-  Do not install the product within the reach of young children.  
The product may fall and injure children.
-  Edible oil, such as soybean oil, can damage or deform the product. Do not install the product in a kitchen or near a kitchen counter.
-  Have a technician install the wall-mount hanger.
  - Installation by an unqualified person can result in an injury.
  - Only use approved cabinets.
-  Install the product at least 10 cm away from the wall to allow ventilation.  
An increased internal temperature may cause a fire.
-  Keep the plastic packaging out of the reach of children.  
Children may suffocate.
-  Do not install the product in a vehicle or a place exposed to dust, moisture (water drips, etc.), oil, or smoke.  
A fire or electric shock may result.



-  Following installation, it is recommended to dehumidify the LED Signage product before use.
  - This helps prevent moisture damage and maintain optimal performance.
  - For product dehumidification, refer to the supplied installation manual. The installation manual is available for download at [www.samsung.com/displaysolutions](http://www.samsung.com/displaysolutions).

## Caution

-  Do not set down the product on its front.  
The screen may become damaged.
-  When installing the product on a cabinet or shelf, make sure that the bottom edge of the front of the product is not protruding.
  - The product may fall and become damaged and/or cause an injury.
  - Install the product only on cabinets or shelves of the right size.
-  Do not drop the product while moving. Product failure or personal injury may result.
-  Set down the product gently.  
Product failure or personal injury may result.
-  Installing the product in an unusual place (a place exposed to a lot of fine dust, chemical substances, extreme temperatures or a significant presence of moisture, or a place where the product will operate continuously for an extended period of time) may seriously affect its performance.  
Be sure to consult Samsung Customer Service Centre if you want to install the product at such a place.

## Operation

### Warning

-  There is a high voltage inside the product. Never disassemble, repair or modify the product yourself.
  - A fire or electric shock may result.
  - Contact Samsung Customer Service Centre for repairs.
-  If the product is dropped or the outer case is damaged, turn off the power switch and disconnect the power cord. Then contact Samsung Customer Service Centre.



Continued use can result in a fire or electric shock.
-  Do not leave heavy objects or items that children like (toys, sweets, etc.) on top of the product.

The product or heavy objects may fall as children try to reach for the toys or sweets resulting in a serious injury.
-  Do not move the product by pulling the power cord or any cable.

Product failure, an electric shock or fire may result from a damaged cable.
-  Do not lift or move the product by pulling the power cord or any cable.

Product failure, an electric shock or fire may result from a damaged cable.
-  Ensure the vents are not blocked by tablecloths or curtains.

An increased internal temperature may cause a fire.
-  Do not insert metallic objects (chopsticks, coins, hairpins, etc) or objects that burn easily (paper, matches, etc) into the product (via the vent or input/output ports, etc).
  - Be sure to power off the product and disconnect the power cord when water or other foreign substances have entered the product. Then contact Samsung Customer Service Centre.
  - Product failure, an electric shock or fire may result.

-  Do not place objects containing liquid (vases, pots, bottles, etc) or metallic objects on top of the product.
  - Be sure to power off the product and disconnect the power cord when water or other foreign substances have entered the product. Then contact Samsung Customer Service Centre.
  - Product failure, an electric shock or fire may result.
-  Before moving the product, turn off the power switch and disconnect the power cable and all other connected cables.

Damage to the cord may result in a fire or electric shock.
-  If the product generates abnormal sounds, a burning smell or smoke, disconnect the power cord immediately and contact Samsung Customer Service Centre.

An electric shock or fire may result.
-  During a lightning or thunderstorm, power off the product and remove the power cable.

A fire or electric shock may result.
-  Do not drop objects on the product or apply impact.







A fire or electric shock may result.
-  If a gas leakage is found, do not touch the product or power plug. Also, ventilate the area immediately.

Sparks can cause an explosion or fire.
-  Do not use or keep combustible spray or an inflammable substance near the product.

An explosion or fire may result.

---

## Caution

-  The screen is bright. Keep a sufficient distance from the screen.
  - Continuously looking at the screen up close is bad for your eyes.
  - Keep at least the recommended viewing distance (pixel pitch x 3.5 m) from the screen.  
e.g. For IAB 146 4K:  $0.84 \times 3.5 \text{ m} =$  a distance of at least 2.9 m is recommended
-  Do not use humidifiers or stoves around the product.  
A fire or electric shock may result.
-  Do not touch the screen when the product has been turned on for an extended period of time as it will become hot.
-  Do not place heavy objects on the product.  
Product failure or personal injury may result.
-  Disconnect the power cord from the power socket if you do not plan on using the product for an extended period of time (vacation, etc).  
  
Dust accumulation combined with heat can cause a fire, electric shock or electric leakage.
-  Store small accessories out of the reach of children.

## Cleaning

The LED structure is revealed on the front of the monitor. Exercise caution to ensure that you do not touch the structure. There is a risk that the LED element may fall or become damaged.

To clean the exterior, use the soft cleaning cloth that came with the monitor to wipe the exterior gently.

(The installation manual is available for download at [www.samsung.com/displaysolutions](http://www.samsung.com/displaysolutions).)

Contact Customer Service Centre if the inside of the product needs cleaning (service fee will be charged).



# Chapter 02

## Preparations

### Checking the Components

- Contact the vendor where you purchased the product if any components are missing.
- The appearance of the components may differ from the images shown.
- A stand is not provided with the product. To install a stand, you can purchase one separately.



Quick Setup Guide



Warranty card  
(Not available in some locations)



Regulatory guide



Power cord  
(IAB 146 4K, IAB 146 2K: x 2 / IAB 110 2K: x 1)



Remote Control

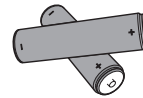

Batteries (AAA x 2)  
(Not available in some locations)

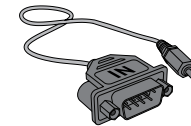

RS232C adapter

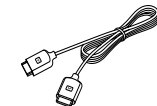

OCM cable  
(IAB 146 4K, IAB 146 2K: x 4 / IAB 110 2K: x 3)

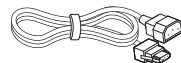

Power extension cable  
(IAB 146 4K, IAB 146 2K: x 2 / IAB 110 2K: x 1)

# Ports

## IAB 146 4K / IAB 146 2K

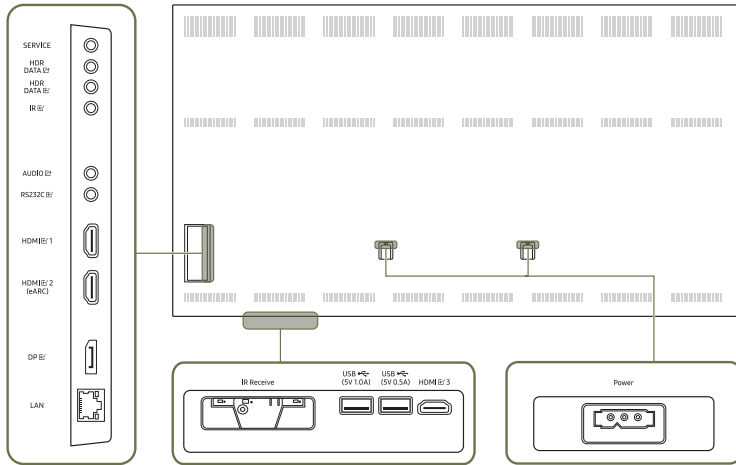

## IAB 110 2K

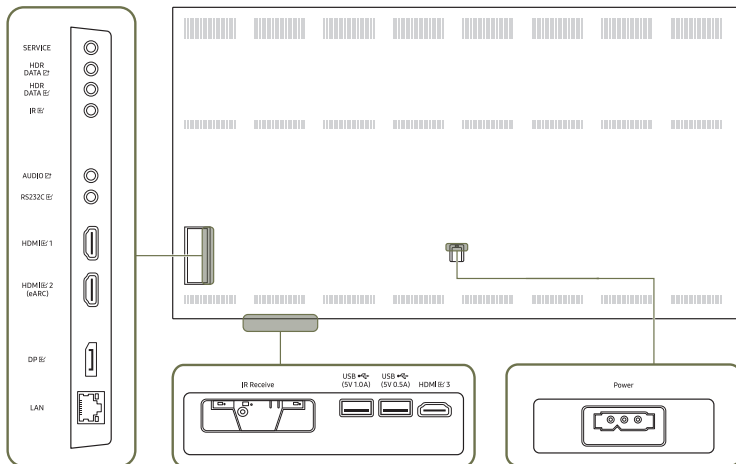

Ports	Description
SERVICE	Dedicated to service technicians.
HDR DATA I2	Connects to the HDR DATA E port on the next cabinet.
HDR DATA E	Connects to the HDR DATA I2 port on the previous cabinet to receive video data.
IR E	Connects to an external IR cable that receives signals from the remote control.
AUDIO I2	Outputs sound to an audio device via an audio cable.
RS232C E	Connects to MDC using an RS232C adapter.
HDMI E 1	Connects to a source device using a HDMI cable or HDMI-DVI cable.
HDMI E 2 (eARC)	
HDMI E 3	
DP E	Connects to a PC using a DP cable.
LAN	Connects to MDC and the Internet using a LAN cable. (10/100 Mbps) <p> Use Cat7(*STP Type) cable for the connection.                      *Shielded Twist Pair.</p>
USB (5V 1.0A)	Connect to a USB memory device. <p> The USB ports on the product accept a maximum constant current of 1.0A. If the maximum value is exceeded, USB ports may not work.</p>
USB (5V 0.5A)	Connect to a USB memory device. <p> The USB ports on the product accept a maximum constant current of 0.5A. If the maximum value is exceeded, USB ports may not work.</p>

# Remote Control

- ✎ Using other display devices in the same space as the remote control of this product can cause the other display devices to be inadvertently controlled.
- ✎ A button without a description in the image below is not supported on the product.

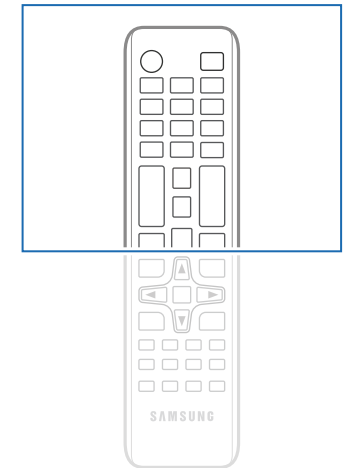
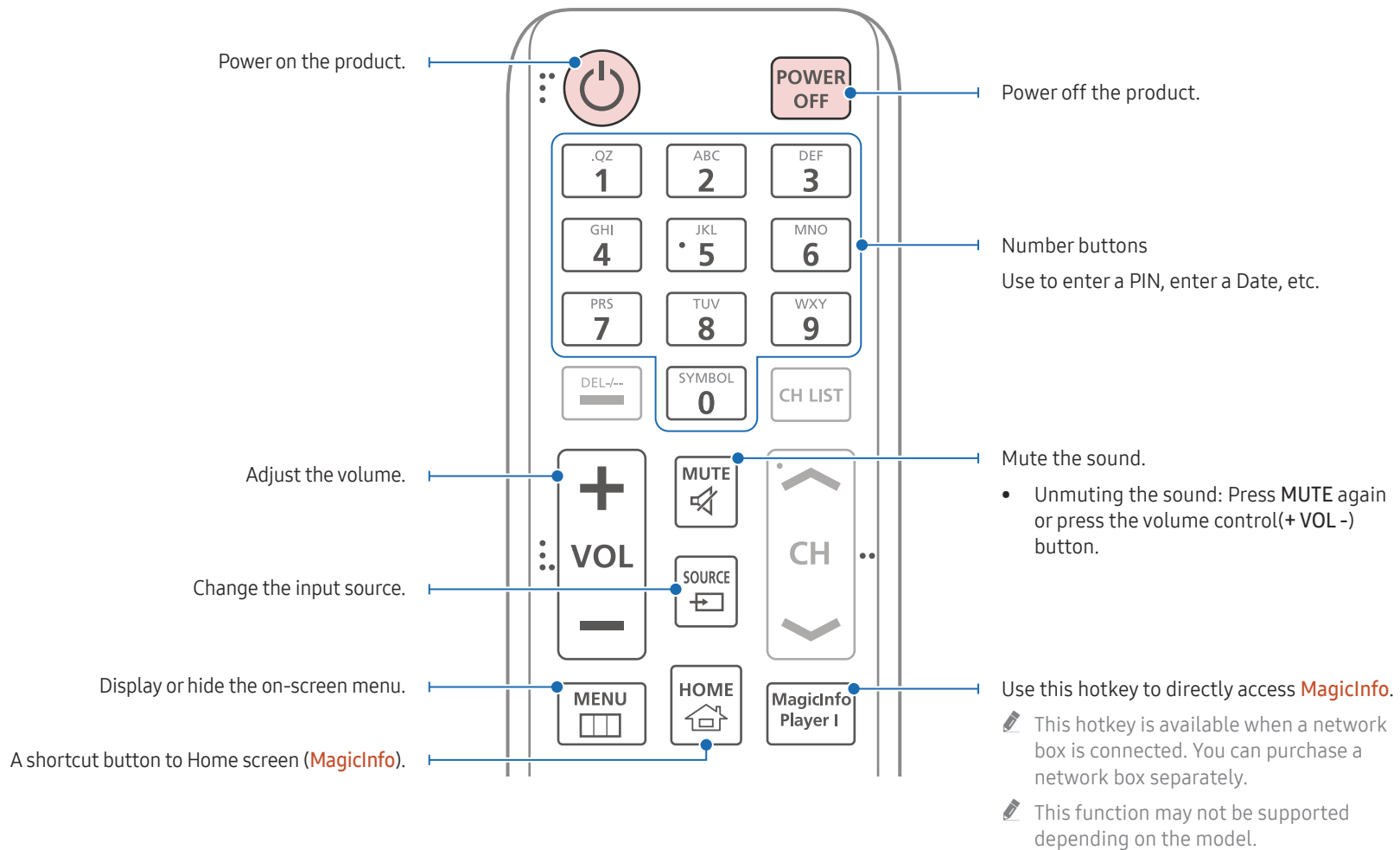

- ✎ Remote control button functions may differ for different products.

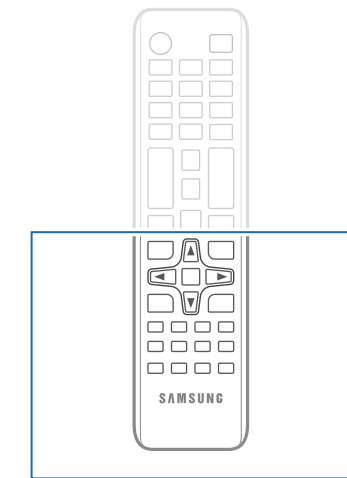
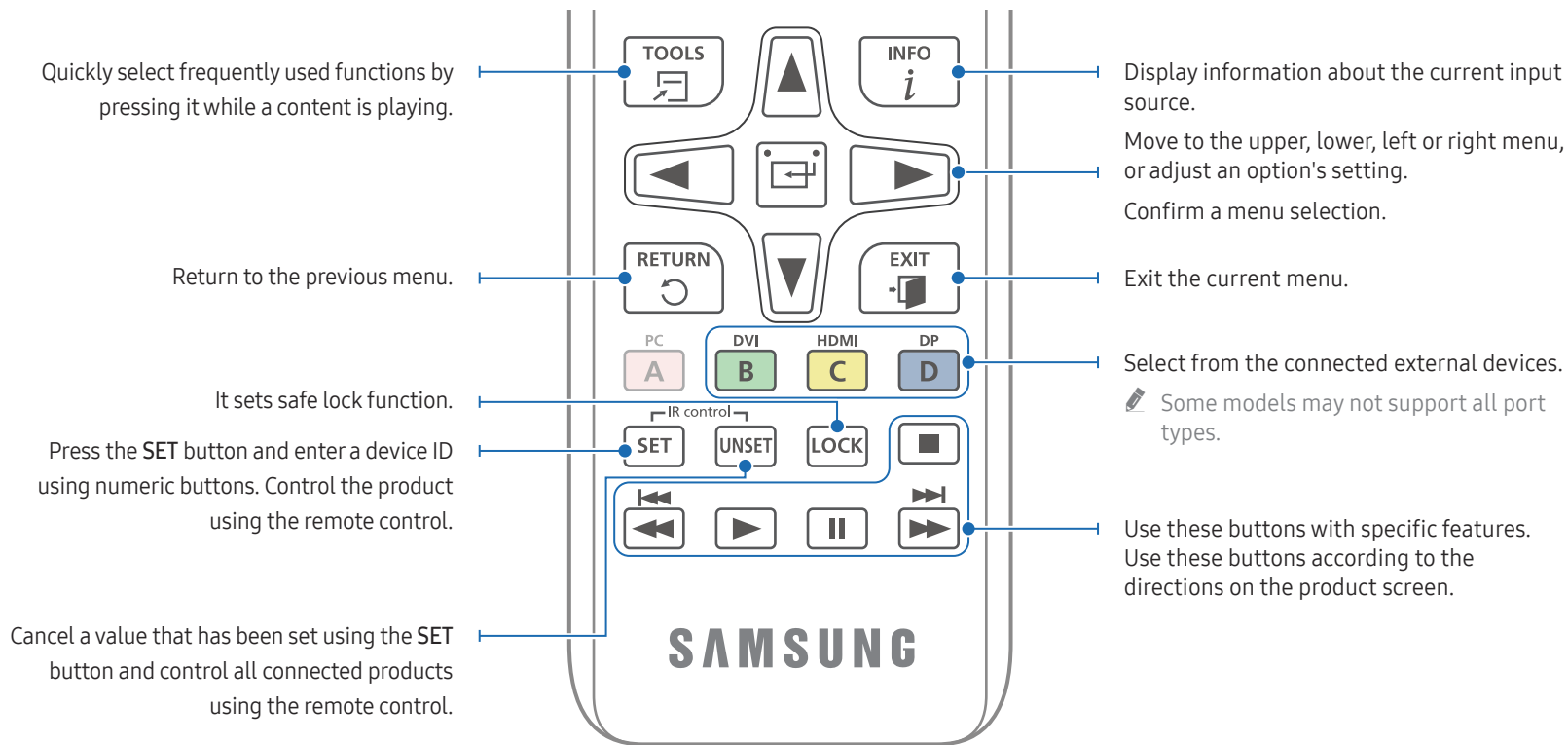

*Remote control button functions may differ for different products.*

## To place batteries in the remote control (AAA x 2)

*Remove batteries when the remote control is not to be used for an extended period of time.*

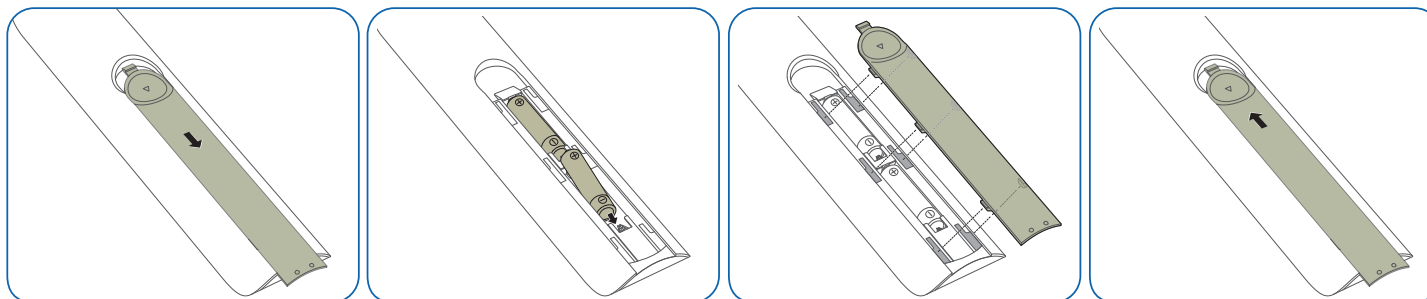

# Chapter 03

## Connecting Devices

### Precautions when handling the cabinets

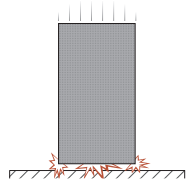

[Caution to prevent external shock and dropping of the product]

After removing the protective brackets, be careful not to expose the product to external shocks or vibrations. Make sure that the product is not dropped from any height.

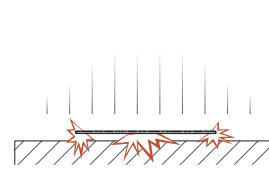

[Caution to prevent damage to the LED]

After removing the protective brackets, do not place the product on the floor with the LED facing down.

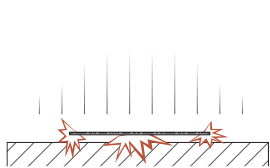

[Caution to prevent damage to the LED]

Be careful not to expose the product to vibrations or external shocks when it is lying flat on the floor.

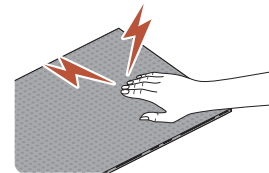

[Caution to prevent damage to the LED from static]

Do not touch the product without anti-static gloves.

- Be sure to wear anti-static gloves when touching the product.

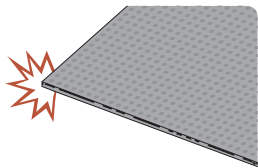

[Caution to prevent damage to corners]

Take extra care to ensure that the corners of a cabinet do not get damaged.

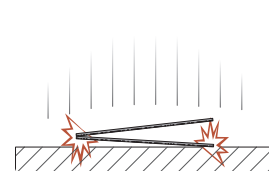

[Caution to prevent damage to the LED]

When lifting the product, be careful that the module frame does not separate from the main frame.

## Installing the product

- Make sure you entrust the installation to a professional installation service provider. For further information regarding installation, contact the dealer you purchased the product from.
- Install the product using the frame kit provided by the manufacturer. For more information refer to the installation guide.
- Samsung shall not be liable for any damage to the product and any injury to the users or others that may be incurred while the users install the product by themselves.

e.g.) IAB 146 4K

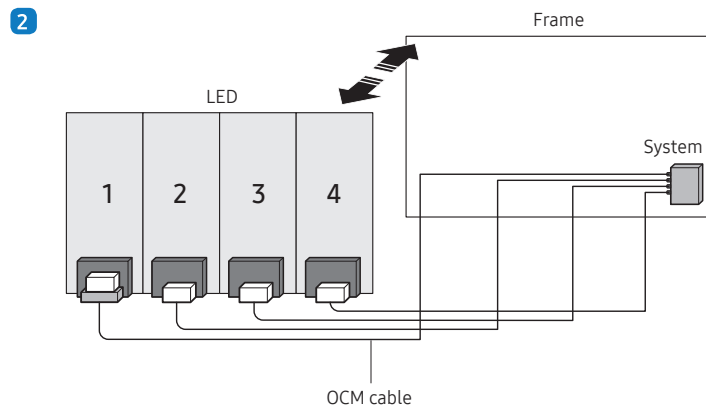
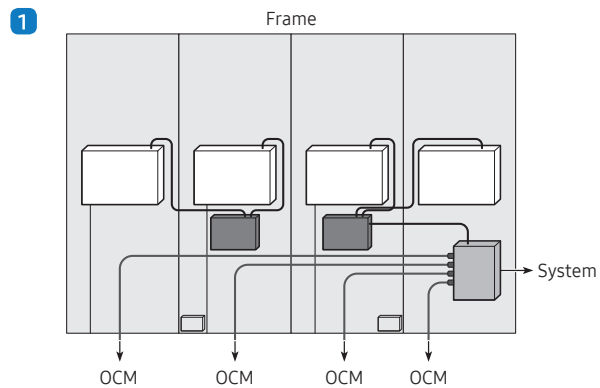

## Connecting the Power Cable

- Connect the power cable after all cables are connected.
- Before connecting external devices, be sure to disconnect the power cable.
- AC power cables may not be provided depending on the model. Contact the dealer from whom you purchased the product if you want to be purchased separately.

e.g.) IAB 146 4K

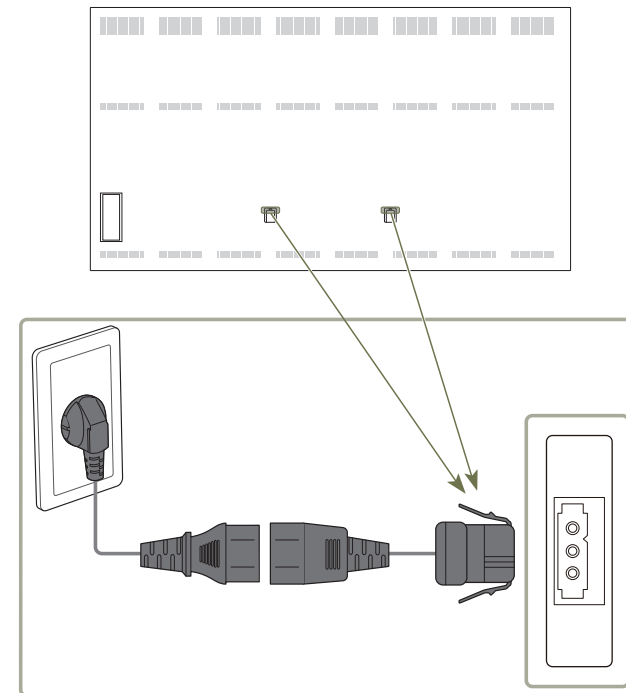

# Chapter 04

## Player feature

Accessible using the HOME button on the remote control.

### Player

HOME → **Player** → ENTER

Play a range of content such as channels with schedules assigned, templates or files.

This function may not be supported depending on the model.

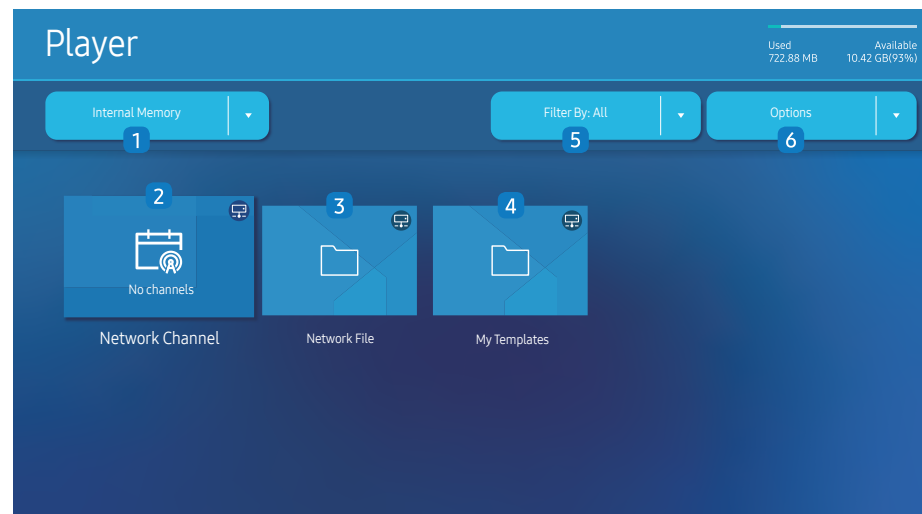

The displayed image may differ depending on the model.

You must set **Clock Set** before you can use this feature.

No.	Description
1	Select between internal or external memory.
2	Play content, templates and schedules configured on the server. <ul style="list-style-type: none"> <li>You can view whether the server is connected (approval) in the <b>Player</b> screen. To view whether the server is connected when a Network Channel is running, press <b>INFO</b> on the remote control.</li> </ul> <ol style="list-style-type: none"> <li>Select <b>Network Channel</b> from the <b>Player</b> screen. The <b>No channels</b> message appears if no channel has been registered in <b>Network Channel</b>.</li> <li><b>Network Channel</b> will run.</li> </ol>
3	Play content stored on the server.
4	Play templates stored in <b>My Templates</b> folder in the Internal Memory. <ul style="list-style-type: none"> <li> This function may not be supported depending on the model.</li> </ul>
5	Select a content type as criterion to search for a desired content list.
6	Set different options for <b>Player</b> .

### Viewing content

- Select either internal or external memory. The files saved in the selected memory appear.
- Select the desired file. The content appears on the screen. (For more information on compatible file formats, see the "File formats compatible with Player" section.)

## When content is running

### Control buttons on the remote control

You can play, pause, or skip the content on the playlist by pressing buttons on the remote control.

Button	Function
TOOLS	Brings up the menu bar.
INFO	Displays the general information of the content.
▶	Goes to next file or page.
◀	Goes to previous file or page.
◀ / ▶ / ⏸	Plays or pauses slide show or video content.
■	Stops displaying content and goes to the <b>Player</b> screen.
◀◀	Rewinds the video content.
▶▶	Fast forwards the video content.

- ✎ If there is only one image file in the Internal Memory or USB, the Slide Show will not play.
- ✎ If the name of a folder is too long on the USB, you cannot select the folder.
- ✎ **Portrait** option for **Content Orientation** is not available for contents with a resolution higher than 3840 x 2160.
- ✎ **Content Size** for videos with a resolution higher than 3840 x 2160 supports **Full Screen** only.

## Available menu

Press the TOOLS button on the remote control during content playback to configure settings.

Menu	Description
<b>Playlist</b>	View a list of content items currently playing.
<b>Web Element Zoom</b>	50 / 100 / 200 / 300
<b>Sound Mode</b>	Customises the audio settings for the content currently playing.
<b>Repeat All / Repeat One</b>	Set the repeat mode.
<b>Background Music</b>	Set the background music to be played when content is running.
<b>Reset</b>	Reset the background music.
<b>Pause</b>	Pause the background music.
<b>Prev</b>	Play the previous background music on the list.
<b>Next</b>	Play the next background music on the list.

✎ **Reset, Pause, Prev, Next** only appear when the background music is set.

✎ This function may not be supported depending on the model.



---

## File Formats Compatible with Player

- Supported file systems include FAT32 and NTFS.
- A file with a vertical and horizontal resolution larger than the maximum resolution cannot be played. Check the vertical and horizontal resolution of the file.
- Check the supported video and audio Codec types and Versions.
- Check the supported file versions.
  - ✎ PowerPoint version up to 97 – 2013 is supported
- ✎ For USB-**Internal Memory** file transfer, click **Options** → **Send**. Wait for about a 50 seconds before **OK** message appears.
  - Location of template files
    - **Internal Memory** → USB transfer: USB → under MagicinfoSlide folder
    - USB → **Internal Memory** transfer: **Internal Memory** → under My Templates folder
  - Location of other files (non-template)
    - **Internal Memory** → USB transfer: USB → under MagicinfoSlide folder
    - USB → **Internal Memory** transfer: Under the root folder
- ✎ This function may not be supported depending on the model.

## Network Schedule Multiframe

### Playback restrictions



- 1 to 3 FHD video files can be played simultaneously or only one UHD video file and one FHD video file at a time. In portrait playback mode, 3 FHD video files can be played simultaneously or only one UHD video file at a time.
- For **Office** files (PPT and Word files) and **PDF** files, only one file type is supported at a time.
- LFD(\*.LFD) files are not supported.
- Contents with a resolution higher than 3840 x 2160 are not supported.

### Sound output restrictions

- More than one sound output cannot be used.
- Playback priority: network BGM → local BGM → video file in the main frame selected by the user
  - ✎ Network BGM: Settings can be configured when creating a server schedule.
  - ✎ Local BGM: BGM settings can be configured using the tools displayed after the **TOOLS** button is pressed during **Player** playback.
  - ✎ User-selected main frame: Main frame settings can be configured when creating a server schedule.

## Template files(\*.LFD)

### Restrictions

- Check that you have **Contents** and **Schedules** folders published to the USB storage device.
  - ✎ A properly published content appears as Published Content  in the USB device.
  - ✎ When copying a content you published to a USB device (Published Content ) to the **Internal Memory**, the content appears in **Internal Memory** as Published Content  only. Contents and Schedules folders are not visible under **Internal Memory**.

### Playback restrictions

- A maximum of two video (**Video**) files can be played.
- For **Office** files (PPT and Word files) and **PDF** files, only one file type is supported at a time.
- When playing more than one video files simultaneously, make sure that the display areas are not overlapping one another.

### Sound output restrictions

- More than one sound output cannot be used.
- Playback priority: network BGM → local BGM → video file in the main frame selected by the user

## Supported video codecs

File format	Container	Video codecs	Resolution	Frame rate (fps)	Bit rate (Mbps)	Audio codecs	
*.avi	AVI MKV ASF MP4 3GP MOV FLV VRO VOB PS TS SVAF	H.264 BP/MP/HP	3840 x 2160	120	60	Dolby Digital LPCM ADPCM(IMA, MS) AAC HE-AAC WMA Dolby Digital+ MPEG(MP3) AC-4 G.711(A-Law, $\mu$ -Law) OPUS	
*.mkv		HEVC (H.265 - Main, Main10)			100		
*.asf		Motion JPEG		30	80		
*.wmv		MVC	1920 x 1080	60	20		
*.mp4		MPEG4 SP/ASP					
*.mov		Window Media Video v9 (VC1)					
*.3gp		MPEG2					
*.vro		MPEG1					
*.mpg		Microsoft MPEG-4 v1, v2, v3					30
*.mpeg		Window Media Video v7(WMV1), v8(WMV2)					
*.ts		H 263 Sorenson					
*.tp		VP6					
*.trp		VP6		3840 x 2160	120		80
*.flv		AV1					
*.vob		VP8	1920 x 1080	60	20		Vorbis
*.svi		VP9 (Profile 0, profile 2 supported)	3840 x 2160	60	80		
*.m2ts	AV1	120		80			
*.mts	AV1	120	80				
*.webm	WebM	VP8	1920 x 1080	60	20	Vorbis	
		VP9 (Profile 0, profile 2 supported)	3840 x 2160	60	80		
		AV1		120	80		
*.rmvb	RMVB	RV8/9/10 (RV30/40)	1920 x 1080	60	20	RealAudio 6	

---

## Other restrictions

- Codecs may not function properly if there is a problem with the content.
- Video content does not play or does not play correctly if there is an error in the content or container.
- Sound or video may not work if they have standard bit rates/frame rates above the TV's compatibility ratings.
- If the Index Table is has an error, the Seek (Jump) function will not work.
- When playing video over a network connection, the video may not play smoothly because of data transmission speeds.
- Some USB/digital camera devices may not be compatible with the TV.
- HEVC codec is only available in MKV / MP4 / TS containers.
- The MVC codec is supported partly.



## Video decoders

- H.264 UHD is supported up to Level 5.1, and H.264 FHD is supported up to Level 4.2 (TV does not support FMO / ASO / RS).
- HEVC UHD is supported up to Level 5.2, and HEVC FHD is supported up to Level 4.1.
- HEVC 8K is supported up to Level 6.1.
- VC1 AP L4 is not supported.
- GMC 2 or above is not supported.
- When a single video file is playing, Seamless mode is not supported under the following conditions:
  - Incompatible codec (MVC, VP3, MJPEG) ↔ Incompatible codec
  - Incompatible codec ↔ Compatible codec
  - The resolution is different from that of the monitor
  - The frequency is different from that of the monitor

## Audio decoders

- WMA is supported up to 10 Pro 5.1 channels, M2 profile.
- WMA1, WMA lossless / Voice are not supported.
- QCELP and AMR NB/WB are not supported.
- Vorbis is supported for up to 5.1 channels.
- Dolby Digital+ is supported for up to 5.1 channels.
- The supported sample rates are 8, 11.025, 12, 16, 22.05, 24, 32, 44.1, and 48 kHz, and differ with the codec.

## Image

- Compatible image file format: JPEG, PNG, BMP
  -  32-bit, 24-bit and 8-bit BMP files are supported.
- Supported maximum resolution: 7680 x 4320 (JPEG), 4096 x 4096 (PNG, BMP)
  -  When playing 10 files in one LFD file - 5120 x 5120
- Supported maximum file size: 20MB
- Supported **Slideshow Effect**: 9 effects  
(**Fade1, Fade2, Blind, Spiral, Checker, Linear, Stairs, Wipe, Random**)

Power Point	PDF	WORD
<ul style="list-style-type: none"> <li>• Compatible document file formats               <ul style="list-style-type: none"> <li>– Extension : ppt, pptx</li> <li>– Version : Office 97 ~ Office 2013</li> </ul> </li> <li>• Functions not supported               <ul style="list-style-type: none"> <li>– Animation effect</li> <li>– 3D shapes (which will be displayed in 2D)</li> <li>– Header and footer (some subitems are not supported)</li> <li>– Word Art</li> <li>– Align                   <ul style="list-style-type: none"> <li>A group alignment error may occur</li> </ul> </li> <li>– Office 2007                   <ul style="list-style-type: none"> <li>SmartArt is not fully supported. 97 out of 115 subitems are supported.</li> </ul> </li> <li>– Object insertion</li> <li>– Half-width characters</li> <li>– Letter spacing</li> <li>– Charts</li> <li>– Vertical text                   <ul style="list-style-type: none"> <li>Some subitems are not supported</li> </ul> </li> <li>– Slide notes and handout</li> </ul> </li> </ul>	<ul style="list-style-type: none"> <li>• Compatible document file formats               <ul style="list-style-type: none"> <li>– Extension : pdf</li> </ul> </li> <li>• Functions not supported               <ul style="list-style-type: none"> <li>– Content less than 1 pixel not supported because of performance degradation issue.</li> <li>– Masked Image, Tiled Image content not supported.</li> <li>– Content with Rotated Text, not supported.</li> <li>– 3D Shadow Effects not supported.</li> <li>– Some characters not supported                   <ul style="list-style-type: none"> <li>(Special characters may be corrupted)</li> </ul> </li> </ul> </li> </ul>	<ul style="list-style-type: none"> <li>• Compatible document file formats               <ul style="list-style-type: none"> <li>– Extension : .doc, .docx</li> <li>– Version : Office 97 ~ Office 2013</li> </ul> </li> <li>• Functions not supported               <ul style="list-style-type: none"> <li>– Page background effect</li> <li>– Some paragraph styles</li> <li>– Word Art</li> <li>– Align                   <ul style="list-style-type: none"> <li>A group alignment error may occur</li> </ul> </li> <li>– 3D shapes (which will be displayed in 2D)</li> <li>– Office 2007                   <ul style="list-style-type: none"> <li>SmartArt is not fully supported. 97 out of 115 subitems are supported.</li> </ul> </li> <li>– Charts</li> <li>– Half-width characters</li> <li>– Letter spacing</li> <li>– Vertical text                   <ul style="list-style-type: none"> <li>Some subitems are not supported</li> </ul> </li> <li>– Slide notes and handout</li> </ul> </li> </ul>

# Schedule

HOME  → Schedule → ENTER 

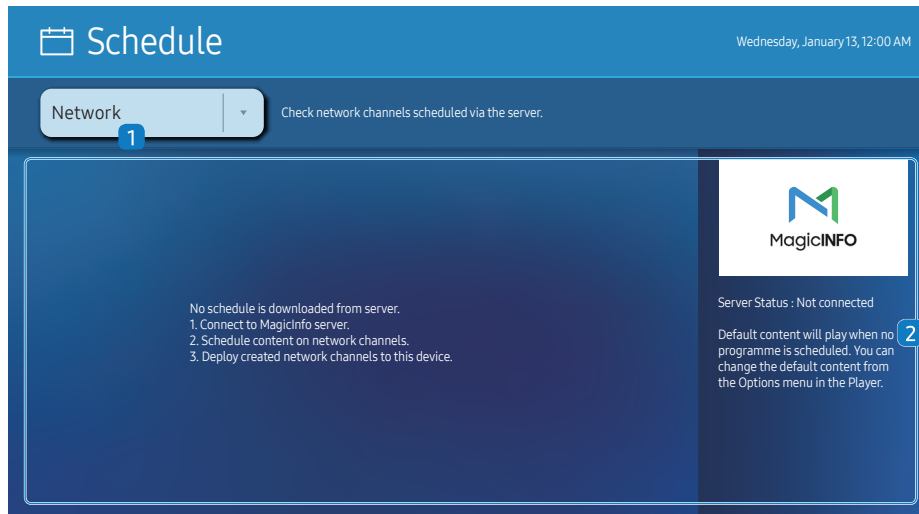

 The displayed image may differ depending on the model.

You can check the schedule imported from a selected storage device.

 This function may not be supported depending on the model.

No.	Description
1	Select the saved location of the schedule.
2	Create/Edit/Delete/View schedule of content playback.

---

## Custom Home

HOME  → Custom Home → ENTER 

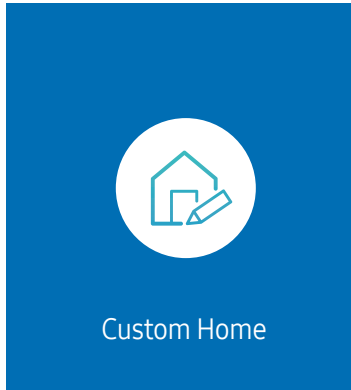

---

 The displayed image may differ depending on the model.

Enter your 6 digit PIN number. The default PIN number is "0-0-0-0-0-0". If you want to change the PIN number, use the **Change PIN** function.

Select an item to run in Custom Home mode. Press the Home key to return to this screen.

# Clone Product

HOME  → Clone Product → ENTER 

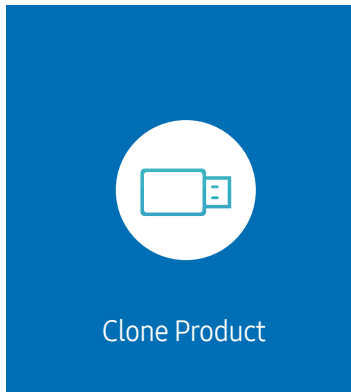

 The displayed image may differ depending on the model.

Export settings on the product to an external storage device. You can also import settings from an external storage device.

This option is useful when assigning the same settings to several products.

## When a duplicate file is not found on the external storage device

- 1 Connect the external storage device, then run the **Clone Product** function.
- 2 The **No cloning file found on the external storage device. Export this device's settings to the external storage device?** message appears.
- 3 Select **Export** to export the settings.

## When a duplicate file is found on the external storage device

- 1 Connect the external storage device, then run the **Clone Product** function.
- 2 The **Cloning file found. Please select an option.** message appears.  
Run the **Import from External Storage** or **Export to External Storage** function.
  - **Import from External Storage:** Copy settings saved on an external storage device to the product.  
 After configuration is complete, the product is rebooted automatically.
  - **Export to External Storage:** Copy settings on the product to an external storage device.

# ID Settings

HOME  → ID Settings → ENTER 

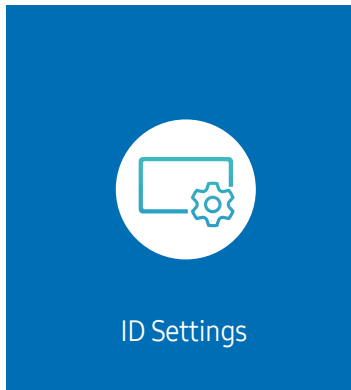

 The displayed image may differ depending on the model.

Assign an ID to a set.

## Device ID

Set a unique ID number for each product.

 Press ▲/▼ to select a number, and press .

 Enter the number you want using the number buttons on the remote control.

## Device ID Auto Set

This feature automatically allots an ID number to a device connected via an RS232C cable.

 This function is only available on the first device within an RS-232C daisy chain.

 This function may not be supported depending on the model.

## PC Connection Cable

Select which type of cable you are using to connect the display to the PC.

- **RS232C cable**  
Communicate with MDC via the RS232C cable.
- **RJ-45 (LAN)/Wi-Fi Network** or **RJ-45 (LAN) Cable**  
Communicate with MDC via the RJ45 cable.

 Available functions may differ depending on the model.



# Video Wall

HOME  → Video Wall → ENTER 

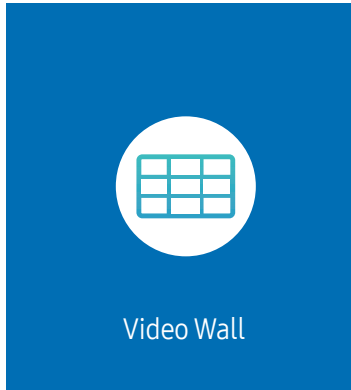

 The displayed image may differ depending on the model.

Customise the layout of multiple displays that are connected to form a video wall.

In addition, display part of a whole picture or repeat the same picture on each of the connected multiple displays.

To display multiple images, refer to MDC Help or the MagicInfo user guide. Some models may not support the MagicInfo function.

 This function may not be supported depending on the model.

## Video Wall

You can activate or deactivate **Video Wall**.

To organise a video wall, select **On**.

- **Off / On**

In some models, the **Video Wall** functions as the Frame Lock.

- Frame Lock operating conditions :
  - **Video Wall** should be set to **On**.
  - **Picture Mode** should be set to **Calibration**.

 When the Frame Lock is operating, the 24/25/30 Hz resolutions are not supported.

## Horizontal x Vertical

This feature automatically splits a videowall display based on a videowall matrix configuration.

Enter the videowall matrix.

The videowall display is split based on the configured matrix. The number of vertical or horizontal display devices can be set within the range 1 and 15.

 A videowall display can be split into a maximum of 225 screens.

 The **Horizontal x Vertical** option is only enabled when **Video Wall** is set to **On**.

---

## Screen Position

To rearrange split screens, adjust the number for each product in the matrix using the **Screen Position** feature.

Selecting **Screen Position** will display the videowall matrix with the numbers assigned to the products that form the videowall.

To rearrange products, use the direction buttons on the remote control to move a product to another desired number. Press the  button.

 **Screen Position** allows you to split the screen into a maximum of 225 views (15 x 15).

 The **Screen Position** option is only enabled when **Video Wall** is set to **On**.

 To use the function, make sure **Horizontal x Vertical** is configured.

## Format

Select how to display images on the videowall display.

- **Full**: Display images in full screen with no margin.
- **Natural**: Display images in the original aspect ratio without enlarging or reducing the size.

 The **Format** option is only enabled when **Video Wall** is set to **On**.

---

# Network Status

Check the current network and Internet connection.

HOME  → Network Status → ENTER 

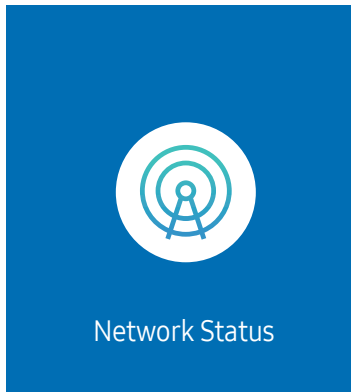

---

 The displayed image may differ depending on the model.

---

## Picture Mode

This menu provides an optimum picture quality suitable for the environment where the product will be used.

- **Dynamic / Standard / Movie / Live / Calibration**

HOME  → **Picture Mode** → ENTER 

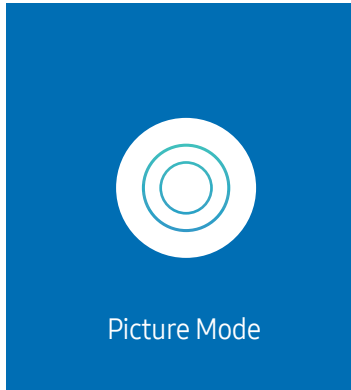



---

 The displayed image may differ depending on the model.

# On/Off Timer

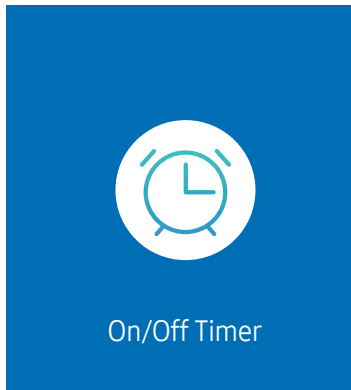
HOME  → On/Off Timer → ENTER 



 The displayed image may differ depending on the model.

 You must set **Clock Set** before you can use this feature.

## On Timer

Set **On Timer** so that your product turns on automatically at a time and on a day of your choice.

The power is turned on with the specified volume or input source.

**On Timer**: Set the on timer by making a selection from one of the seven options. Ensure you set the current time first.

(**On Timer1** ~ **On Timer7**)

 While the internal/USB memory option can be used with **On Timer** for **MagicInfo** mode, it is recommended to use an internal memory.

 Proper operation of **On Timer** feature cannot be guaranteed if used with a battery powered USB device, which can take longer to be recognised.

- **Setup**: Select **Off**, **Once**, **Everyday**, **Mon~Fri**, **Mon~Sat**, **Sat~Sun** or **Manual**. If you select **Manual**, you can choose the days you want **On Timer** to turn on your product.
  - The check mark indicates days you've selected.
- **Time**: Set the hour and minute. Use the number buttons or the up and down arrow keys to enter numbers. Use the left and right arrow buttons to change entry fields.
- **Volume** (For models with built-in speakers): Set the desired volume level. Use the up and down arrow buttons to change the volume level.
- **Source**: Select the input source of your choice.
- **Content** (when the **Source** is set to **Internal/USB** for **MagicInfo** mode): From the USB device or internal memory, select a file (e.g. music, photo, or video) to play just after the product is turned on.

---

## Off Timer

Set the off timer (**Off Timer**) by making a selection from one of the seven options. (**Off Timer1 ~ Off Timer 7**)

- **Setup:** Select **Off**, **Once**, **Everyday**, **Mon~Fri**, **Mon~Sat**, **Sat~Sun** or **Manual**. If you select **Manual**, you can choose the days you want **Off Timer** to turn off your product.
  - The check mark indicates days you've selected.
- **Time:** Set the hour and minute. Use the number buttons or the up and down arrow keys to enter numbers. Use the left and right arrow buttons to change entry fields.

## Holiday Management

Timer will be disabled during a period specified as a holiday.

- **Add Holiday:** Specify the period you want to add as a holiday.  
Select the start and end dates of the holiday you want to add using the ▲/▼ buttons, and click the **Done** button.  
The period will be added to the list of holidays.
  - **Start Date:** Set the start date of the holiday.
  - **End Date:** Set the end date of the holiday.
- **Delete:** Delete selected items from the list of holidays.
- **Edit:** Select a holiday item and then change the date.
- **Apply to Timers:** Set the **On Timer** and **Off Timer** to not activate on public holidays.
  - Press  to select the **On Timer** and **Off Timer** settings you do not want to activate.
  - The selected **On Timer** and **Off Timer** will not activate.

# Ticker

HOME  → Ticker → ENTER 

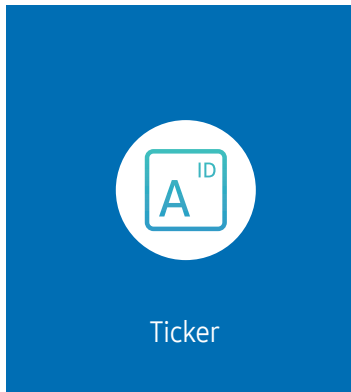

 The displayed image may differ depending on the model.

Input text while a video or image is displayed and display the text on the screen.





 You must set **Clock Set** before you can use this feature.

- **Off / On:** Set whether or not to use **Ticker**.
- **Message:** Enter a message to display on the screen.
- **Time:** Set the **Start Time** and **End Time** to display a **Message**.
- **Font options:** Specify the text font and colour for the message.
- **Position:** Select a position to display a **Message**.
- **Scroll:** Turn scroll effects of **Ticker** on or not. Specify the scroll **Direction** and **Speed** for the message.
- **Preview:** Preview your **Ticker** settings.





# Chapter 05





## Menu



### Picture





2nd	3rd	Description
Picture Mode		Select the picture mode that best suits your viewing environment. <ul style="list-style-type: none"><li>• <b>Dynamic / Standard / Movie / Live / Calibration</b></li></ul>
LED Brightness		Adjust the brightness of the LED Screen.  Lowering the brightness of the LED screen reduces power consumption.
Brightness / Contrast / Sharpness		Your product has several options for adjusting picture quality.  You can adjust and store settings for each external device you have connected to an input on the product.  Lowering picture brightness reduces power consumption.
Colour Temperature		It sets colour temperature. The value and temperature increase simultaneously, so the ratio of blue colour rises. (Range: 2800K–16000K)  Enabled when <b>Colour Tone</b> is set to <b>Off</b> .  Available only when <b>Picture Mode</b> is set to <b>Calibration</b> .



2nd	3rd	Description
<b>Advanced Settings</b>		Configure advanced picture settings to create your preferred picture.
	<b>Picture Enhancer</b>	Displays enhanced colour and sharpness.
	<b>Colour</b>	Adjust the colour saturation levels. Colour saturation intensifies as the value nears 100. (Range: 0~100)
	<b>Tint (G/R)</b>	Adjust the ratio of green to red tint levels. Increasing values intensifies the saturation of red and green colours. (Range: 0~50)
	<b>White Balance</b>	<p>Adjust the colour temperature of the picture so that white objects appear brighter.</p> <ul style="list-style-type: none"> <li>• <b>2 Point</b> Adjust red, green, and blue luminosity levels in two sections for precise white balance optimisation.</li> <li>• <b>20 Point Settings</b> Controls the white balance in 20 point interval by adjusting the red, green, and blue brightness. <ul style="list-style-type: none"> <li>– <b>20 Point</b> Adjust red, green, and blue luminosity levels in twenty sections for precise white balance optimisation.</li> </ul> </li> </ul> <p> Some external devices may not support this function.</p>
	<b>Gamma</b>	<p>Adjust the mid-range brightness of the picture.</p> <p> <b>Gamma</b> settings <b>HLG</b>, <b>ST.2084</b>, and <b>BT.1886</b> may change depending on the input video settings. For models with the <b>HDR+ Mode</b> support, the <b>Gamma</b> settings <b>HLG</b>, <b>ST.2084</b>, and <b>BT.1886</b> may change depending on the input video and <b>HDR+ Mode</b> settings. If <b>HDR+ Mode</b> is set to <b>Off</b>, <b>HLG</b>, <b>ST.2084</b>, and <b>BT.1886</b> settings may be available depending on the input video. To adjust <b>S Curve</b>, set <b>HDR+ Mode</b> to <b>Off</b>.</p> <ul style="list-style-type: none"> <li>• <b>HLG / ST.2084 / BT.1886 / 2.2 / S Curve</b> Adjust the <b>HLG</b>, <b>ST.2084</b>, <b>BT.1886</b>, <b>S Curve</b> levels of the picture. <ul style="list-style-type: none"> <li> If <b>2.2</b> is selected, level adjustment is not possible.</li> <li> Available functions may differ depending on the port type.</li> </ul> </li> </ul>
	<b>Contrast Enhancer</b>	Automatically balance the contrast to prevent excessive differences between bright and dark areas.
	<b>Black Tone</b>	Select the black level to adjust the screen depth.
	<b>Flesh Tone</b>	Adjust the flesh tone colour by increasing or decreasing red levels.

2nd	3rd	Description
Advanced Settings	Colour Space Settings	<p>Configure colour space settings to refine the spectrum of colours on your screen.</p> <ul style="list-style-type: none"> <li> <b>Colour Space</b>            Choose a colour space.           <ul style="list-style-type: none"> <li> To adjust <b>Colour</b>, <b>Red</b>, <b>Green</b>, <b>Blue</b> and <b>Reset</b>, set <b>Colour Space</b> to <b>Custom</b>.</li> </ul> </li> </ul>
	Input Signal Plus	<p>Expands the input signal range for HDMI connections.</p> <ul style="list-style-type: none"> <li>  IAB 146 4K            When <b>Input Signal Plus</b> is set to <b>On</b>, up to the 3840 x 2160 @ 60 Hz resolution is supported.            When <b>Input Signal Plus</b> is set to <b>Off</b>, up to the 3840 x 2160 @ 30 Hz resolution is supported.         </li> <li> This function may not be supported depending on the model.</li> <li> Connecting parts may differ depending on the model.</li> </ul>
LED HDR		<p>Set options to provide an optimal HDR effect.</p> <p>To prevent this, set the sub functions of <b>LED HDR</b> to <b>Off</b>.</p>
	Inverse Tone Mapping	<p>Make the dark elements of the image darker and the bright elements brighter to make the image as realistic as possible.</p>
	Dynamic Peaking	<p>Enlarge the difference of instantaneous maximum/minimum luminance so that the bright parts can be expressed more clearly.</p> <ul style="list-style-type: none"> <li><b>Off / Low / Medium / High</b></li> </ul>
	Multi-link HDR Settings	<p>Set the options to provide an HDR effect when the resolution is higher than 4K.</p> <ul style="list-style-type: none"> <li><b>Multi-link HDR</b>: Turn on to provide an HDR effect for all connected devices when the resolution is higher than 4K.</li> <li><b>Number of Devices</b>: Select the number of linked devices.</li> <li><b>Device ID</b>: Select the ID of this device.</li> </ul>

2nd	3rd	Description
Picture Options	Colour Tone	Select the colour tone that best suits your viewing preferences.  Settings can be adjusted and stored for each external device connected to an input on the product.  Available options may vary depending on the product.
	Digital Clean View	Reduce picture noise to avoid distractions such as flickering.
	HDMI Black Level	Adjust the black level to optimise the HDMI picture brightness and contrast.  Only available if the input signal from the external device connected to the HDMI port is RGB444.
	Film Mode	Make frame transitions from older video sources smoother. This function is only available when the input signal is TV, AV, Component (480i, 1080i), or HDMI (1080i).
	Auto Motion Plus Settings	Enhance picture sharpness to optimize for fast-moving images. Select Custom to configure Blur Reduction and Judder Reduction. (Off / Auto / Custom) <ul style="list-style-type: none"> <li>• Auto Motion Plus</li> <li>• Blur Reduction</li> <li>• Judder Reduction</li> </ul>
Apply Picture Settings		Apply the picture settings to all external devices connected to the device or to the current source only.





2nd	3rd	Description
<b>Picture Size Settings</b>		<p>Choose size and aspect ratio picture displayed on screen.</p> <p> Some external devices and applications may not support this function.</p>
	<b>Picture Size</b>	<p>Different screen adjustment options are displayed depending on the current input source.</p> <p> Available functions may differ depending on the model or input signals.</p> <p> Do not set your product to <b>4:3</b> format for a long time. The borders displayed on the left and right, or top and bottom of the screen may cause image retention (screen burn) which is not covered by the warranty.</p>
	<b>Fit to screen</b>	Adjusts the picture position. When selected, the full programme image will be displayed. No part of the image will be cut off.
	<b>Zoom and Position</b>	<p>Adjusts the picture zoom and position. This function is available only if <b>Picture Size</b> is set to <b>Custom</b>.</p> <p> If you want to reset the picture to its original position, select <b>Reset</b> in the <b>Zoom and Position</b> screen. The picture will be set to its default position.</p>
<b>Reset Picture</b>		Restore all picture settings to the factory default.







---

## OnScreen Display

2nd	3rd	Description
Screen Protection	Screen Saver	Activate a screensaver when your device displays a still image for two hours or more.
Message Display	Source Info	Select whether to display the source OSD when the input source changes.
	No Signal Message	Select whether to display the no-signal OSD when no signal is detected. The message <b>No Cable Connected</b> will appear if no source device is connected.
	MDC Message	Select whether to display the MDC OSD when the product is controlled by the MDC.
Language		Set the menu language.  A change to the language setting will only be applied to the onscreen menu display. It will not be applied to other functions on your PC.
Reset OnScreen Display		This option returns the current settings under <b>OnScreen Display</b> to the default factory settings.

## Sound

2nd	3rd	Description
Sound Mode		<p>You can select a sound mode to suit your personal preferences.</p> <p> This function is disabled when <b>Sound Output</b> is set to <b>External</b> or <b>Receiver (HDMI-eARC)</b>.</p>
Balance		<p>Adjust speaker volume levels for sound balance optimisation.</p> <p> This function is disabled when <b>Sound Output</b> is set to <b>External</b> or <b>Receiver (HDMI-eARC)</b>.</p> <p> Available functions may differ depending on the model.</p>
Equaliser		<p>Adjust the equaliser to customise the volume and pitch, and enhance the richness of the sound output.</p> <p> Available only when <b>Sound Mode</b> is set to <b>Standard</b>.</p> <p> This function is disabled when <b>Sound Output</b> is set to <b>External</b> or <b>Receiver (HDMI-eARC)</b>.</p>
Digital Output Audio Format		<p>Select the digital audio output format. When <b>Pass-through</b> is selected, the input audio will be sent to the receiver without any processing. This option is only supported when the source is HDMI and the receiver is connected via HDMI eARC or ARC.</p>
Dolby Atmos		<p>Provides a realistic surround sound experience when watching Dolby Atmos content.</p>

2nd	3rd	Description
<p><b>Sound Output</b></p>		<p>Select speakers for sound output.</p> <ul style="list-style-type: none"> <li> When you set <b>Sound Output</b> to <b>External</b> or <b>Receiver (HDMI-eARC)</b>, the internal speaker is turned off. You will hear sound through the external speakers only.</li> <li> The audio is available both for internal and external speakers while connected via the <b>AUDIO</b> port with the <b>Sound Output</b> option set to <b>Internal</b>. Connecting parts may differ in different products.</li> <li> To select the <b>Receiver (HDMI-eARC)</b> option, set <a href="#">Anynet+ (HDMI-CEC)</a> to <b>On</b> while the product is connected to the AV Receiver's HDMI(eARC) port.</li> <li> If there is no video signal, both the products speakers and the external speakers will be mute.</li> </ul>
<p><b>Auto Volume</b></p>		<p>Automatically adjusts the volume level when you change video sources or content so the level remains the same.</p> <ul style="list-style-type: none"> <li> To use the volume control of a connected source device, set <b>Auto Volume</b> to <b>Off</b>.</li> <li> This function is disabled when <b>Sound Output</b> is set to <b>External</b> or <b>Receiver (HDMI-eARC)</b>.</li> </ul>
<p><b>Reset Sound</b></p>		<p>Reset all sound settings to the factory defaults.</p>

---

## Network

2nd	3rd	Description
<a href="#">Network Status</a>		You can check the current network and Internet status.
<a href="#">Open Network Settings</a>		Configure network settings to connect to an available network.
	<a href="#">Network Type</a>	 <a href="#">Network Type</a> menu may not be available in Wired models.



# Network Settings (Wired)

## Connecting to a Wired Network

There are three ways to attach your product to your LAN using cable.

- You can attach your product to your LAN by connecting the LAN port on the back of your product to an external modem using a LAN cable. See the diagram below.

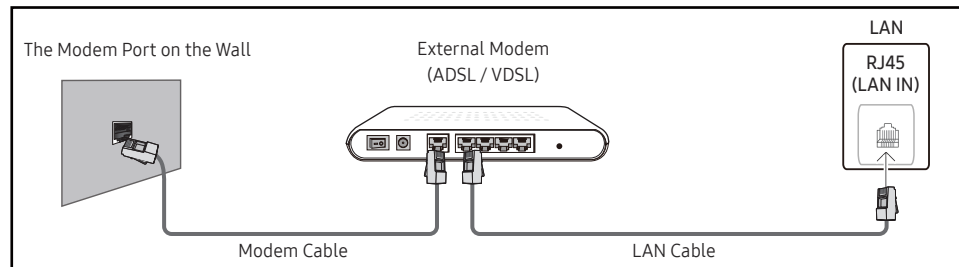

- You can attach your product to your LAN by connecting the LAN port on the back of your product to an IP Sharer which is connected to an external modem. Use LAN cable for the connection. See the diagram below.

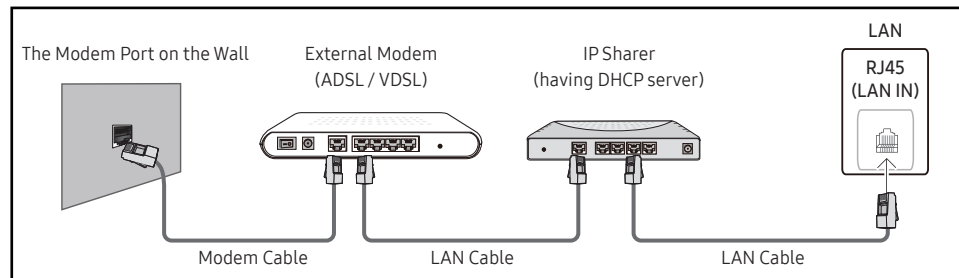

- Depending on how your network is configured, you may be able to attach your product to your LAN by connecting the LAN port on the back of your product directly to a network wall outlet using a LAN cable. See the diagram below. Note that the wall outlet is attached to a modem or router elsewhere in your house.

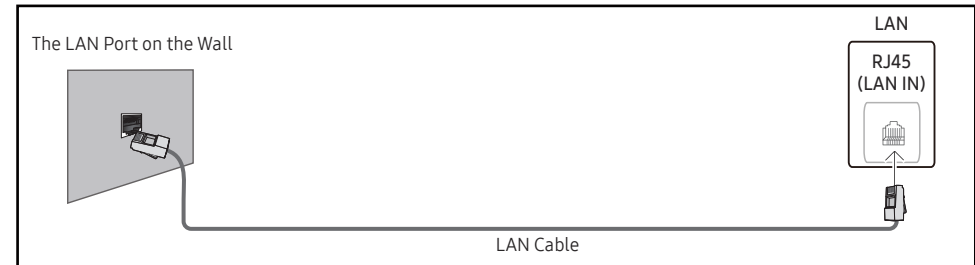

If you have a Dynamic Network, you should use an ADSL modem or router that supports the Dynamic Host Configuration Protocol (DHCP). Modems and routers that support DHCP automatically provide the **IP Address**, **Subnet Mask**, **Gateway**, and DNS values your product needs to access the Internet so you do not have to enter them manually. Most home networks are Dynamic Networks.

Some networks require a Static IP address. If your network requires a Static IP address, you must enter the **IP Address**, **Subnet Mask**, **Gateway**, and DNS values manually on your product **IP Settings** when you set up the network connection. To get the **IP Address**, **Subnet Mask**, **Gateway**, and DNS values, contact your Internet Service Provider (ISP).

If you have a Windows computer, you can also get these values through your computer.

- ✎ You can use ADSL modems that support DHCP if your network requires a Static IP address.
- ✎ ADSL modems that support DHCP also let you use Static IP addresses.

---

Set the network connection to use Internet services such as perform software upgrades.

## Automatic Open Network Settings (Wired)

Connect to the network using a LAN cable.

Make sure a LAN cable is connected first.

### How to set up automatically

- 1 Set **Network Type** to **Wired** from the **Open Network Settings** page.

 For wired models, select **Network Status** menu.

- 2 The network test screen appears and verifies the network connection.

When the connection has been verified, the “**Success! Your device is connected to the Internet. If you have any problems using online services, please contact your Internet service provider.**” message appears.

 If the connection process fails, check the LAN port connection.

 If the automatic process cannot find the network connection values or if you want to set the connection manually, go to the next section(Manual Open Network Settings (Wired)).

## Manual Open Network Settings (Wired)

Offices may use static IP addresses.

If this is the case, ask the network administrator for the **IP Address**, **Subnet Mask**, **Gateway** and DNS server address. Enter these values manually.

### Getting the Network Connection Values

To view the Network connection values on most Windows computers, follow these steps.

- 1 Right click the Network icon on the bottom right of the screen.
- 2 In the pop-up menu that appears, click Status.
- 3 On the dialog that appears, click the **Support** tab.
- 4 On the **Support** Tab, click the **Details** button. The Network connection values are displayed.

 The path to the settings depends on the installed OS.

### How to set up manually

- 1 Set **Network Type** to **Wired** from the **Open Network Settings** page.

The network test screen appears and the verification process starts. Press **Cancel**. The verification process stops.

 For wired models, select **Network Status** menu.

- 2 Select **IP Settings** on network connection screen. The **IP Settings** screen appears.

- 3 Select the field at the top, press , and then set **IP setting** to **Enter manually**. Repeat the entry process for each field in the **IP Address**.

 Setting **IP setting** to **Enter manually** automatically changes **DNS setting** to **Enter manually**.

- 4 When done, select **OK** at the bottom of the page, and then press . The network test screen appears and the verification process starts.

- 5 When the connection has been verified, the “**Success! Your device is connected to the Internet. If you have any problems using online services, please contact your Internet service provider.**” message appears.



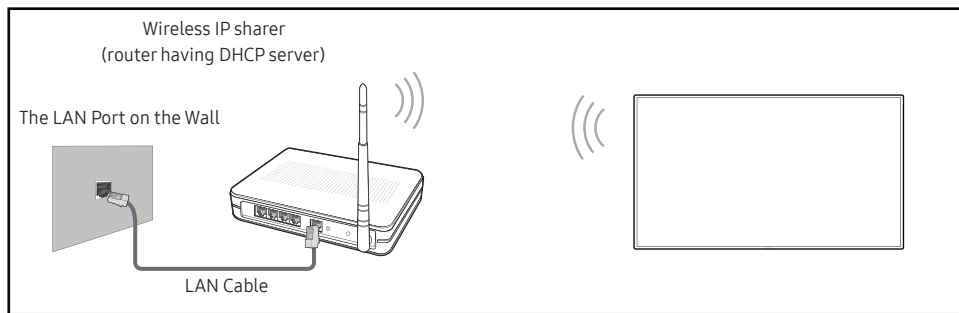

## Network Settings (Wireless)

 This function may not be supported depending on the model.

### Connecting to a Wireless Network



Samsung recommends using IEEE 802.11n. When you play video over a network connection, the video may not play smoothly.

-  Select a channel for the wireless IP sharer that is not currently being used. If the channel set for the wireless IP sharer is currently being used by another device nearby, this will result in interference and communication failure.
-  Your product supports only the following wireless network security protocols.
  - Authentication Modes: WEP, WPAPSK, WPA2PSK
  - Encryption Types: WEP, TKIP, AESIn compliance with the Wi-Fi certification specifications, Samsung products do not support WEP or TKIP security encryption in networks running in the High-throughput(Greenfield) 802.11n mode.
-  If your wireless router supports WPS (Wi-Fi Protected Setup), you can connect to the network via PBC (Push Button Configuration) or PIN (Personal Identification Number). WPS will automatically configure the SSID and WPA key in either mode.
-  Connection Methods: You can setup the wireless network connection in three ways. Automatic Network Setup, Manual Network Setup, **Use WPS**





## Automatic Network Setup (Wireless)

Most wireless networks have an optional security system that requires devices that access the network to transmit an encrypted security code called an Access or Security key. The Security key is based on a Pass Phrase, typically a word or a series of letters and numbers of a specified length you were asked to enter when you set up security for your wireless network. If you use this method of setting up the network connection, and have a Security key for your wireless network, you will have to enter the Pass Phrase during the automatic or manual setup process.

### How to set up automatically

- 1 Set **Network Type** to **Wireless** from the **Open Network Settings** page.
- 2 The **Network** function searches for available wireless networks. When done, it displays a list of the available networks.

In the list of networks, press the ▲ or ▼ button to select a network, and then press the  button.

  -  If the desired wireless router does not appear, select **Refresh** to search again.
  -  If the router cannot be found after retrying, select the **Add Network**.
- 3 If the **Enter the password for (AP Name)** screen appears, go to step 4. If you select a wireless router that does not have security, go to step 6.
- 4 If the router has security, enter the **Enter the password for (AP Name)**. (Security key or PIN).
- 5 When done, use the right arrow button to move the cursor to **Done**, and then press . The network connection screen appears and the verification process starts.
  -  A connection with the router is established, but the Internet cannot be accessed. In this case, contact your Internet service provider.
- 6 When the connection has been verified, the **“Success! Your device is connected to the Internet. If you have any problems using online services, please contact your Internet service provider.”** message appears.

---

## Manual Network Setup (Wireless)

Offices may use static IP addresses.







If this is the case, ask the network administrator for the **IP Address, Subnet Mask, Gateway** and DNS server address. Enter these values manually.

### Getting the Network Connection Values

To view the Network connection values on most Windows computers, follow these steps.

- 1 Right click the Network icon on the bottom right of the screen.
- 2 In the pop-up menu that appears, click Status.
- 3 On the dialog that appears, click the **Support** tab.
- 4 On the **Support** Tab, click the **Details** button. The Network connection values are displayed.

### How to set up manually

- 1 Set **Network Type** to **Wireless** from the **Open Network Settings** page.
- 2 The **Network** function searches for available wireless networks. When done, it displays a list of the available networks.
- 3 In the list of networks, press the ▲ or ▼ button to select a network, and then press the  button twice.
  -  If the desired wireless router does not appear, select **Refresh** to search again.
  -  If the router cannot be found after retrying, select the **Stop** button. The **Add Network** button appears.
- 4 If the **Enter the password for (AP Name)** screen appears, go to step 5. If you select a wireless router that does not have security, go to step 7.
- 5 If the router has security, enter the **Enter the password for (AP Name)**. (Security key or PIN).
- 6 When done, use the right arrow button to move the cursor to **Done**, and then press . The network connection screen appears and the verification process starts.
- 7 Select **Cancel** while network connections are being attempted. This will stop the connection.
- 8 Select **IP Settings** on network connection screen. The **IP Settings** screen appears.
- 9 Select the field at the top, press , and then set **IP setting** to **Enter manually**. Repeat the entry process for each field in the **IP Address**.
  -  Setting **IP setting** to **Enter manually** automatically changes **DNS setting** to **Enter manually**.
- 10 When done, select **OK** at the bottom of the page, and then press . The network test screen appears and the verification process starts.
- 11 When the connection has been verified, the **“Success! Your device is connected to the Internet. If you have any problems using online services, please contact your Internet service provider.”** message appears.

---







## Use WPS

 This function may not be supported depending on the model.







### How to set up using Use WPS

If your router has a **Use WPS** button, follow these steps.

- 1 Set **Network Type** to **Wireless** from the **Open Network Settings** page.
- 2 Select **Use WPS**, press .
- 3 Press the WPS or PBC button on your wireless router within the next two minutes. Your product automatically acquires all the network setting values it needs and connects to your network.
  - If you want to use the WPS PIN, select **WPS PIN**.  
Go to your wireless router's Settings, enter your PIN, and then select **OK**.
- 4 The network connection screen appears, and network setup is done.

2nd	3rd	Description
Server Network Settings	Connect to server	<p>Connect to MagicInfo server.</p> <ul style="list-style-type: none"> <li> If you do use the <b>TLS</b> option, the server is configured to use https and data transfer is encrypted. (Port number: 7002)</li> <li> If you don't use the <b>TLS</b> option, enter the server IP address and port number. Use 7001 as the port number. (If you are unable to connect to the server using port number 7001, check with your server administrator to find the correct port number and then change the port number.)</li> <li> Enter the server IP address and port number. Use 7001 as the port number. (If unable to connect to the server using port number 7001, check with your server administrator to find the correct port number and then change the port number.)</li> <li> For the MagicInfo Server user guide, visit the following website: <a href="http://displaysolutions.samsung.com">http://displaysolutions.samsung.com</a> → Support → Resources → MagicInfo Web Manual.</li> </ul>
	Verify MagicINFO Server	Enable this option to block HTTPS communication if the domain name of the MagicINFO Server URL is different from the domain name of the MagicINFO Server certificate.
	MagicInfo Mode	<p>Select the appropriate <b>MagicInfo Mode</b> depending on the environment where you are using the product.</p> <ul style="list-style-type: none"> <li> Supported content types may be limited while <b>MagicInfo Mode</b> is set to <b>Lite</b>.</li> </ul>
	Server Access	Allow or deny access to MagicInfo server.
	FTP Mode	Specify the FTP operating mode.
	Proxy server	<p>Set up your proxy server connection and related functions.</p> <ul style="list-style-type: none"> <li> <b>Address / Port / ID</b> and <b>Password</b> are enabled only when <b>Proxy server</b> is set to <b>On</b>.</li> </ul>
Embedded Server Settings	Embedded Server	Turn on to enable the embedded server. Turn off to delete registered server information.
	Server Mode	To use this device as a local web server, set it to 'Server'. If you already have a server device nearby, set it as 'Client' to connect this device to the server.
Wi-Fi		Enable or disable the Wi-Fi. Turn on this option to use features that require a Wi-Fi connection.
Device Name		<p>Select or enter a device name.</p> <p>This name can be shown on network device over the network.</p>

# System



2nd	3rd	Description
Accessibility	High Contrast	Set the background and font to high-contrast colours in Menu. Menu transparencies become opaque when the option is selected.
	Enlarge	Enlarge the size of the Menu area.
Start Setup		Go through the initial setup steps like you did the first time you used this product.  Enter your 6 digit PIN number. The default PIN number is "0-0-0-0-0-0". If you want to change the PIN number, use the <b>Change PIN</b> function.  Change the PIN to keep your device secure.
Time		You can configure <b>Clock Set</b> or <b>DST</b> . Configure various time-related settings.
	Clock Set	Select <b>Clock Set</b> . Select <b>Date</b> or <b>Time</b> , and then press  Use the number buttons to enter numbers or press the up and down arrow buttons. Use the left and right arrow buttons to move from one entry field to the next. Press  when done.  You can set the <b>Date</b> and <b>Time</b> directly by pressing the number buttons on the remote control.
	NTP Settings	Set up the server URL and time zone to use the network time.
	DST	Switches the DST (Daylight Saving Time) function on or off.  <b>Start Date</b> , <b>End Date</b> and <b>Time Offset</b> are enabled only when <b>DST</b> is set to <b>On</b> .
	Power On Delay	When connecting multiple products, adjust the power-on time for each product to prevent power overload (within the range 0–50 seconds).

2nd	3rd	Description
Auto Source Switching	Auto Source Switching	Switch to preset source or another source when the main source device gets disconnected.
	Primary Source Recovery	Select whether to restore the selected primary input source when a primary input source is activated. ✎ The <b>Primary Source Recovery</b> function is disabled if <b>Primary Source</b> is set to <b>All</b> .
	Primary Source	Select a primary source to switch to when no signals are received from the current input.
	Secondary Source	Select a secondary source to switch to when no signals are received from the current input. ✎ The <b>Secondary Source</b> function is disabled if <b>Primary Source</b> is set to <b>All</b> .
	Default Input	Select the default input to switch to when the new input is disconnected. The <b>Last Input</b> option only includes external inputs connected via cables. ✎ <b>Auto Source Switching</b> must be set to <b>New Input</b> to enable the <b>Default Input</b> option.
Power Control	Auto Power On	This feature automatically turns on the product as soon as it is plugged in. Pressing the power button is not needed.
	Max. Power Saving	Conserve power by turning off PC monitor when PC is not used for certain time.
	Standby Control	When no signal is detected, it determines whether or not to enter sleep mode.
	Remote Configuration	Keep the network connection active when the product is turned off.
	Power Button	The power button on the remote control (🔌) can be set to turn on the power or turn on or off the power.
Power and Energy Saving	Brightness Optimization	Reduce the power consumption by adjusting the screen brightness.
	No Signal Power Off	Save power by turning the product off when no signal is received from any source. ✎ This function does not operate if the display is in the standby mode. ✎ The product will automatically power off at a specified time. The time can be changed as required.
	Auto Power Off	Choose how long the display will wait before turning off after no user interaction is detected.











2nd	3rd	Description
External Device Manager		Manage external devices connected to your signage.
	Input Device Manager	<p>Set up keyboards to use with your product. You can add keyboards and configure their setting.</p> <p> Available for Bluetooth enabled models only.</p> <ul style="list-style-type: none"> <li>• <b>Bluetooth Device List</b> Connect a Bluetooth keyboard, mouse or gamepad to your product.</li> <li>• <b>Keyboard Settings</b> Configure the connected keyboard settings. <ul style="list-style-type: none"> <li>– <b>Keyboard Language</b> Set the language of your keyboard.</li> <li>– <b>Keyboard type</b> Set the type of your keyboard.</li> </ul> </li> <li>• <b>Mouse Settings</b> Configure the connected mouse settings. <ul style="list-style-type: none"> <li>– <b>Primary Button</b> Select the button you want to use as the primary button to click and select.</li> <li>– <b>Pointer Speed</b> Set the speed of the mouse pointer.</li> </ul> </li> </ul>
	Device Connection Manager	<p>Allow devices, like smartphones and tablets, on your network to share content with your product.</p> <ul style="list-style-type: none"> <li>• <b>Access Notification</b> Display a notification when a device such as a smartphone or tablet, is connected. If you use a Wi-Fi network that requires a password, turn off this option to automatically connect with devices without viewing notifications.</li> <li>• <b>Device List</b> View and manage connected devices.</li> </ul>

---





2nd	3rd	Description
<b>Play via</b>		Select the appropriate <b>Play via</b> mode depending on the environment where you are using the product. The home screen may be different depending on the setting.
<b>Change PIN</b>		Change your 6-digit Personal Identification Number (PIN). Choose any 6 digits for your PIN and enter it in <b>Enter a new PIN..</b> Reenter the same 6 digits in <b>Enter the PIN again..</b> The product has memorised your new PIN.  The default PIN number is "0-0-0-0-0-0".  Change the PIN to keep your device secure.

---

2nd	3rd	Description
<b>Security</b>		<p> Enter your 6 digit PIN number. The default PIN number is "0-0-0-0-0-0". If you want to change the PIN number, use the <b>Change PIN</b> function.</p> <p> Change the PIN to keep your device secure.</p>
	<b>Safety Lock On</b>	<p>Turn <b>Safety Lock On</b> on or off. <b>Safety Lock On</b> restricts the actions that can be carried out by the remote control. The correct PIN must be entered to turn <b>Safety Lock On</b> off.</p> <ul style="list-style-type: none"> <li>• <b>Power On Button</b> Turn on this feature to enable the remote control's Power button to turn on the product while <b>Safety Lock On</b> is enabled.</li> </ul>
	<b>Button Lock</b>	<p>This menu can be used to lock the buttons on the product.</p> <p>Only the remote control can control the product if <b>Button Lock</b> is set to <b>On</b>.</p>
	<b>Screen Monitoring Lock</b>	<p>Blocks screen images from being monitored by MagicINFO Server.</p>
	<b>USB Auto Play Lock</b>	<p>Select whether to automatically play <b>MagicInfo</b> or <b>MagicInfo Lite</b> content saved on a connected USB device.</p> <p> Your content should be a <b>Published Content</b>  that is authored by using <b>MagicInfo Premium</b> application and published to the USB device you are using. The <b>MagicInfo Premium</b> application programme is available on the website. (<a href="http://displaysolutions.samsung.com">http://displaysolutions.samsung.com</a>)</p> <p> When published to a USB device, your <b>Published Content</b>  is saved to <b>Contents</b> and <b>Schedules</b> folders in the root folder of the connected USB device.</p> <p> Connecting a USB device containing <b>MagicInfo</b> or <b>MagicInfo Lite</b> content displays "<b>USB Auto Play Lock : On</b>" for five seconds.</p>
	<b>Mobile Connection Lock</b>	<p>Restrict other devices on your network, such as smart phones and tablets, to prevent them from sharing content on the product.</p> <ul style="list-style-type: none"> <li>• <b>Screen Mirroring Standby</b> Turn on this option to receive connection requests from any source type.</li> </ul>

2nd	3rd	Description
Security	Remote Management	You can <b>Allow</b> or <b>Deny</b> external commands to access your product via a network.
	Secured Protocol	Secure the protocol between this device and other devices. <ul style="list-style-type: none"> <li>• <b>SNMP Settings</b> Set up your ID and password for the SNMP connection.</li> </ul>
	Server Security Status	You can view the MagicINFO server information.  This function is enabled when connected to MagicINFO or RM server.
	Network Lock	Block external network access. You can register networks on the server to allow access.
	USB Lock	Block connection to external USB ports.
	Certificate Manager	Manage the certificates installed on this device. <ul style="list-style-type: none"> <li>•  Limited supports for Enterprise WPA2 (TLS/TTLS/PEAP) certified models only.</li> <li>• <b>App Certificate</b> View and manage the app certificates installed on this device. Connect a USB flash drive that contains certificates to install them on this device.</li> <li>• <b>Wi-Fi Certificate</b> View and manage the Wi-Fi certificates installed on this device.</li> </ul>







---

2nd	3rd	Description
General	Anynet+ (HDMI-CEC)	<p>Anynet+ is a function that enables you to control all connected Samsung devices that support Anynet+ with your Samsung product remote control. The Anynet+ system can be used only with Samsung devices that have the Anynet+ feature. To be sure your Samsung device has this feature, check if there is an Anynet+ logo on it.</p> <ul style="list-style-type: none"><li> You can only control <b>Anynet+</b> devices using the product remote control, not the buttons on the product.</li><li> The product remote control may not work under certain conditions. If this occurs, reselect the <b>Anynet+</b> device.</li><li> <b>Anynet+</b> works when the AV device supporting <b>Anynet+</b> is in the standby or on status.</li><li> <b>Anynet+</b> supports up to 12 AV devices in total. Note that you can connect up to 3 devices of the same type.</li></ul>

---

## Troubleshooting for Anynet+

Problem	Possible Solution
Anynet+ does not work.	<ul style="list-style-type: none"> <li>• Check if the device is an Anynet+ device. The Anynet+ system supports Anynet+ devices only.</li> <li>• Check if the Anynet+ device power cord is properly connected.</li> <li>• Check the Anynet+ device's Video/Audio/HDMI cable connections.</li> <li>• Check whether <b>Anynet+ (HDMI-CEC)</b> is set to <b>On</b> in the <b>System</b> menu.</li> <li>• Check whether the remote control is Anynet+ compatible.</li> <li>• Anynet+ doesn't work in certain situations. (initial setup)</li> <li>• If you have removed and then reconnected the HDMI cable, please make sure to search devices again or turn your product off and on again.</li> <li>• Check if the Anynet+ function of the Anynet device is set on.</li> </ul>
I want to start Anynet+.	<ul style="list-style-type: none"> <li>• Check if the Anynet+ device is properly connected to the product and check if the <b>Anynet+ (HDMI-CEC)</b> is set to <b>On</b> in the <b>System</b> menu.</li> </ul>
I want to exit Anynet+.	<ul style="list-style-type: none"> <li>• Press the <b>SOURCE</b> button on the product remote control and select a non- Anynet+ device.</li> </ul>
The message " <b>Disconnecting Anynet+ device ...</b> " appears on the screen.	<ul style="list-style-type: none"> <li>• You cannot use the remote control when you are configuring Anynet+ or switching to a view mode.</li> <li>• Use the remote control after the product has completed Anynet+ configuration or has finished switching to Anynet+.</li> </ul>
The Anynet+ device does not play.	<ul style="list-style-type: none"> <li>• You cannot use the play function when initial setup is in progress.</li> </ul>
The connected device is not displayed.	<ul style="list-style-type: none"> <li>• Check whether or not the device supports Anynet+ functions.</li> <li>• Check whether or not the HDMI cable is properly connected.</li> <li>• Check whether <b>Anynet+ (HDMI-CEC)</b> is set to <b>On</b> in the <b>System</b> menu.</li> <li>• Search Anynet+ devices again.</li> <li>• Anynet+ requires an HDMI connection. Make sure the device is connected to your product with an HDMI cable.</li> <li>• Some HDMI cables may not support Anynet+ functions.</li> <li>• If the connection is terminated because there has been a power failure or the HDMI cable has been disconnected, please repeat the device scan.</li> </ul>

2nd	3rd	Description
General	HDMI Hot Plug	This feature is used to activate the time delay to turn on a HDMI source device.
	Custom Logo	<p>You can download, select, and set the display time of a custom logo that appears when the product turns on.</p> <ul style="list-style-type: none"> <li> <b>Custom Logo</b> <ul style="list-style-type: none"> <li> You can select a custom logo (image/video) or turn off the custom logo display.</li> <li> You must download the custom logo from an external USB device to set the custom logo.</li> </ul> </li> <li> <b>Logo Display Time</b> <ul style="list-style-type: none"> <li> If the type of custom logo is <b>Image</b>, you can set the <b>Logo Display Time</b>.</li> </ul> </li> <li> <b>Download Logo File</b> <ul style="list-style-type: none"> <li> You can download a custom logo into the product from an external USB device.</li> <li> The file name of the custom logo you want to download must be saved as “samsung” in all small letters.</li> <li> When there are multiple numbers of external USB connections, the product will attempt to download the custom logo from the last device that has been connected to the product.</li> </ul> </li> </ul> <div style="border: 1px solid black; padding: 5px; margin-top: 10px;"> <p>Custom logo file restrictions</p> <ul style="list-style-type: none"> <li>Images up to 50 MB in size can be used. <ul style="list-style-type: none"> <li>Supported image file: samsung_image.*</li> <li>Supported file extensions: jpg, jpeg, bmp, png</li> </ul> </li> <li>Videos up to 150 MB in size can be used. The recommendation is under 20 seconds in length. <ul style="list-style-type: none"> <li>Supported video file: samsung_video.*</li> <li>Supported file extensions: avi, mpg, mpeg, mp4, ts, wmv, asf</li> </ul> </li> </ul> </div>

2nd	3rd	Description
General	DICOM Simulation Mode	Adjust the display mode to output a picture close to the GSDF standard of DICOM Part 14.  This device cannot be used as a medical diagnostic device, even if the DICOM Simulation Mode is enabled.
	Director Mode	Minimises image processing to display the movie director's original intention on screen.
	Empty Storage	Delete files to make space for new content. Recently played files will not be deleted.
Reset System		Reset all system settings to default.



---

# Support

2nd	3rd	Description
<b>Software Update</b>		<p>The <b>Software Update</b> menu lets you upgrade your product software to the latest version.</p> <ul style="list-style-type: none"><li>✎ Be careful not to turn off the power until the upgrade is complete. The product will turn off and on automatically after completing the software upgrade.</li><li>✎ When you upgrade software, all video and audio settings you have made will return to their default settings. We advise you to write down your settings so that you can easily reset them after the upgrade.</li></ul>
	<b>Update Now</b>	<p>Update the software to the latest version.</p> <ul style="list-style-type: none"><li>✎ <b>Current version:</b> This is the software version already installed in the product.</li><li>• Updating via USB Device Download the update package from Samsung's website to a USB storage device and then connect the device to the product to update the product's software.<ul style="list-style-type: none"><li>✎ Remember to save the update package to the top-most directory of the USB device. Otherwise, the product will not be able to find the update package.</li></ul></li><li>• Updating through the network<ul style="list-style-type: none"><li>✎ This function can be run when the network is connected properly.</li></ul></li></ul>

---

2nd	3rd	Description
<a href="#">Contact Samsung</a>		<p>You can view the address of the Samsung website, the call centre phone number, your product's model number, software version, Open Source Licence and other information.</p> <ul style="list-style-type: none"> <li>Go to <a href="#">Contact Samsung</a> and find the product <a href="#">Model Code</a> and <a href="#">Software Version</a>.</li> </ul>
<a href="#">Terms &amp; Privacy</a>		<p>View and set the privacy policy for MagicInfo and other services.</p> <ul style="list-style-type: none"> <li>Make sure that the product is connected to the network.</li> <li>Menu items may vary depending on the model.</li> <li>The availability may vary depending on the region.</li> <li>This feature is enabled only when "Smart Signage Privacy Notice" is selected during setup.</li> </ul>
<a href="#">Device Care</a>		<p>Optimize and diagnose the condition of your Signage. You can check and clean your storage space, diagnose problems or request technical support.</p>
<a href="#">Reset All</a>		<p>This option returns all the current settings for a display to the default factory settings.</p>

# Chapter 06

## Specifications

### General

Model Name		IAB146 4K	IAB110 2K	IAB 146 2K
Cabinet	Pixel Pitch	0.84 mm	1.26 mm	1.68 mm
	LED pixel configuration	Flip-chip RGB LED		
	Pixels (Row x Column)	240 x 180 pixels	160 x 120 pixels	120 x 90 pixels
	Aspect ratio (W:H)	16:9 (806.4 x 453.6)		
Power Supply		AC100-240V~ 50/60Hz Refer to the label at the back of the product as the standard voltage can vary in different countries.		
Environmental considerations	Operating	Temperature : 0 °C - 40 °C (32 °F - 104 °F) Humidity : 10% - 80%RH, non-condensing		
	Storage	Temperature : -20 °C - 45 °C (-4 °F - 113 °F) Humidity : 5% - 95%RH, non-condensing * Applicable before the product package is unpacked.		

---

- Plug-and-Play

This monitor can be installed and used with any Plug-and-Play compatible systems. Two-way data exchange between the monitor and PC system optimises the monitor settings. Monitor installation takes place automatically. However, you can customise the installation settings if desired.

- For detailed device specifications, visit the Samsung website.

## Preset Timing Modes

### ✎ Horizontal Frequency

The time required to scan a single line from the left to the right side of the screen is called a horizontal cycle. The reciprocal number of a horizontal cycle is called horizontal frequency. Horizontal frequency is measured in kHz.

### ✎ Vertical Frequency

The product displays a single image multiple times per second (like a fluorescent light) to display what the viewer sees. The rate of a single image being displayed repeatedly per second is called vertical frequency or refresh rate. Vertical frequency is measured in Hz.

✎ This product can be set to only one resolution for each screen size to obtain the optimum picture quality due to the nature of the panel. Using a resolution other than the specified resolution may degrade the picture quality. To avoid this, it is recommended that you select the optimum resolution specified for your product.

### ✎ IAB146 4K

When **Input Signal Plus** is set to **On**, up to the 3840 x 2160 @ 60 Hz resolution is supported.

When **Input Signal Plus** is set to **Off**, up to the 3840 x 2160 @ 30 Hz resolution is supported.

- This function may not be supported depending on the model.

Model Name		IAB146 4K / IAB110 2K / IAB146 2K
Synchronization	Horizontal Frequency	30 ~ 135 kHz (DP), 15 ~ 135 kHz (HDMI 1~3)
	Vertical Frequency	30 ~ 120 Hz (DP), 24 ~ 120 kHz (HDMI 1~3)

The screen will automatically be adjusted if a signal that belongs to the following standard signal modes is transmitted from your PC. If the signal transmitted from the PC does not belong to the standard signal modes, the screen may be blank with the power indicator on. In such a case, change the settings according to the following table by referring to the graphics card user manual.

### IAB146 4K

Resolution	Horizontal Frequency (kHz)	Vertical Frequency (Hz)	Pixel Clock (MHz)	Sync Polarity (H/V)	HDMI1~3	DP
IBM/VESA, 640 x 480	31.469	59.940	21.175	N / N	O	O
Mac, 640 x 480	35.000	66.667	30.240	N / N	O	O
VESA 640 x 480	37.861	72.809	31.500	N / N	O	O
VESA, 640 x 480	37.500	75.000	31.500	N / N	O	O
IBM, 720 x 400	31.469	70.087	28.322	N / P	O	O
VESA, 800 x 600	37.879	60.317	40.000	P / P	O	O
VESA, 800 x 600	48.077	72.188	50.000	P / P	O	O

Resolution	Horizontal Frequency (kHz)	Vertical Frequency (Hz)	Pixel Clock (MHz)	Sync Polarity (H/V)	HDMI1~3	DP
VESA, 800 x 600	46.875	75.000	49.500	P / P	0	0
Mac, 832 x 624	49.726	74.551	57.284	N / N	0	0
VESA, 1024 x 768	48.363	60.004	65.000	N / N	0	0
VESA, 1024 x 768	56.476	70.069	75.000	N / N	0	0
VESA, 1024 x 768	60.023	75.029	78.750	P / P	0	0
VESA, 1152 x 864	67.500	75.000	108.000	P / P	0	0
VESA, 1280 x 720	45.000	60.000	74.250	P / P	0	0
VESA, 1280 x 800	49.702	59.810	83.500	N / P	0	0
VESA, 1280 x 1024	63.981	60.020	108.000	P / P	0	0
VESA, 1280 x 1024	79.976	75.025	135.000	P / P	0	0
VESA, 1366 x 768	47.712	59.790	85.500	P / P	0	0
VESA, 1440 x 900	55.935	59.887	106.500	N / P	0	0
VESA, 1600 x 900	60.000	60.000	108.000	P / P	0	0
VESA, 1680 x 1050	65.290	59.945	146.250	N / P	0	0
VESA, 1920 x 1080	67.500	60.000	148.500	P / P	0	0
VESA, 2560 x 1440	88.787	59.951	241.500	P / N	0	0
VESA, 3840 x 2160	67.500	30.000	297.000	P / P	0	0
VESA, 3840 x 2160	133.312	59.997	533.250	P / N	0	0
CEA-861 VIC 3, 720x480	31.469	59.940	27.000	N / N	0	0
CEA-861 VIC 4, 1280x720	45.000	60.000	74.250	P / P	0	0
CEA-861 VIC 5, 1920x1080i	33.750	60.000	74.250	P / P	0	X
CEA-861 VIC 7, 720(1440)x480i	31.469	59.940	27.000	P / P	0	X

Resolution	Horizontal Frequency (kHz)	Vertical Frequency (Hz)	Pixel Clock (MHz)	Sync Polarity (H/V)	HDMI1~3	DP
CEA-861 VIC 16, 1920 x 1080	67.500	60.000	148.500	P / P	O	O
CEA-861 VIC 18, 720x576	31.250	50.000	27.000	N / N	O	O
CEA-861 VIC 19, 1280x720	37.500	50.000	74.250	P / P	O	O
CEA-861 VIC 20, 1920x1080i	28.125	50.000	47.250	P / P	O	X
CEA-861 VIC 22, 720(1440)x576i	31.250	50.000	27.000	P / P	O	X
CEA-861 VIC 31, 1920x1080	56.250	50.000	148.500	P / P	O	O
CEA-861 VIC 32, 1920x1080	27.000	24.000	74.250	P / P	O	X
CEA-861 VIC 33, 1920x1080	28.125	25.000	74.250	P / P	O	X
CEA-861 VIC 34, 1920x1080	33.750	30.000	74.250	P / P	O	X
CEA-861 VIC63, 1920 x 1080	135.000	120.000	297.000	P / P	O	O
CEA-861 VIC64, 1920 x 1080	112.500	100.000	297.000	P / P	O	O
CEA-861 VIC 93, 3840x2160	54.000	24.000	297.000	P / P	O	X
CEA-861 VIC 94, 3840x2160	56.250	25.000	297.000	P / P	O	X
CEA-861 VIC 95, 3840x2160	67.500	30.000	297.000	P / P	O	X
CEA-861 VIC 96, 3840x2160	112.500	50.000	594.000	P / P	O	X
CEA-861 VIC 97, 3840x2160	135.000	60.000	594.000	P / P	O	X
CEA-861 VIC 98, 4096x2160	54.000	24.000	297.000	P / P	O	X
CEA-861 VIC 99, 4096x2160	56.250	25.000	297.000	P / P	O	X
CEA-861 VIC 100, 4096x2160	67.500	30.000	297.000	P / P	O	X
CEA-861 VIC 101, 4096x2160	112.500	50.000	594.000	P / P	O	X
CEA-861 VIC 102, 4096x2160	135.000	60.000	594.000	P / P	O	X

## IAB110 2K / IAB146 2K

Resolution	Horizontal Frequency (kHz)	Vertical Frequency (Hz)	Pixel Clock (MHz)	Sync Polarity (H/V)	HDMI1-3	DP
IBM/VESA, 640 x 480	31.469	59.940	21.175	N / N	0	0
Mac, 640 x 480	35.000	66.667	30.240	N / N	0	0
VESA 640 x 480	37.861	72.809	31.500	N / N	0	0
VESA, 640 x 480	37.500	75.000	31.500	N / N	0	0
IBM, 720 x 400	31.469	70.087	28.322	N / P	0	0
VESA, 800 x 600	37.879	60.317	40.000	P / P	0	0
VESA, 800 x 600	48.077	72.188	50.000	P / P	0	0
VESA, 800 x 600	46.875	75.000	49.500	P / P	0	0
Mac, 832 x 624	49.726	74.551	57.284	N / N	0	0
VESA, 1024 x 768	48.363	60.004	65.000	N / N	0	0
VESA, 1024 x 768	56.476	70.069	75.000	N / N	0	0
VESA, 1024 x 768	60.023	75.029	78.750	P / P	0	0
VESA, 1152 x 864	67.500	75.000	108.000	P / P	0	0
VESA, 1280 x 720	45.000	60.000	74.250	P / P	0	0
VESA, 1280 x 800	49.702	59.810	83.500	N / P	0	0
VESA, 1280 x 1024	63.981	60.020	108.000	P / P	0	0
VESA, 1280 x 1024	79.976	75.025	135.000	P / P	0	0
VESA, 1366 x 768	47.712	59.790	85.500	P / P	0	0
VESA, 1440 x 900	55.935	59.887	106.500	N / P	0	0
VESA, 1600 x 900	60.000	60.000	108.000	P / P	0	0
VESA, 1680 x 1050	65.290	59.945	146.250	N / P	0	0



Resolution	Horizontal Frequency (kHz)	Vertical Frequency (Hz)	Pixel Clock (MHz)	Sync Polarity (H/V)	HDMI1~3	DP
VESA, 1920 x 1080	67.500	60.000	148.500	P / P	O	O
CEA-861 VIC 3, 720(1440)x480	31.469	59.940	27.000	N / N	O	O
CEA-861 VIC 4, 1280x720	45.000	60.000	74.250	P / P	O	O
CEA-861 VIC 5, 1920x1080i	33.750	60.000	74.250	P / P	O	X
CEA-861 VIC 7, 720(1440)x480i	31.469	59.940	27.000	P / P	O	X
CEA-861 VIC 16, 1920 x 1080	67.500	60.000	148.500	P / P	O	O
CEA-861 VIC 18, 720x576	31.250	50.000	27.000	N / N	O	O
CEA-861 VIC 19, 1280x720	37.500	50.000	74.250	P / P	O	O
CEA-861 VIC 20, 1920x1080i	28.125	50.000	47.250	P / P	O	X
CEA-861 VIC 22, 720(1440)x576i	31.250	50.000	27.000	P / P	O	X
CEA-861 VIC 31, 1920x1080	56.250	50.000	148.500	P / P	O	O
CEA-861 VIC 32, 1920x1080	27.000	24.000	74.250	P / P	O	X
CEA-861 VIC 33, 1920x1080	28.125	25.000	74.250	P / P	O	X
CEA-861 VIC 34, 1920x1080	33.750	30.000	74.250	P / P	O	X
CEA-861 VIC63, 1920 x 1080	135.000	120.000	297.000	P / P	O	O
CEA-861 VIC64, 1920 x 1080	112.500	100.000	297.000	P / P	O	O

# Chapter 07

## Appendix

### Responsibility for the Pay Service (Cost to Customers)

 When the service is requested, in spite of in warranty, we may charge you for a visit from a service technician in the following cases.

#### Not a product defect

Cleaning of the product, Adjustment, Explanation, Re-installation and etc.

- If a service technician gives instructions on how to use product or simply adjusts options without disassembling product.
- If a defect is caused by external environmental factors (Internet, Antenna, Wired Signal, etc.)
- If a product is reinstalled or devices are connected additionally after installing the purchased product for the first time.
- If a product is reinstalled to move to a different spot or to move to a different house.
- If customer requests instructions on how to use because of another company's product.
- If customer requests instructions on how to use the network or another company's programme.
- If customer requests software installation and setup for the product.
- If a service technician removes/cleans dusts or foreign materials inside of the product.
- If customer requests an installation additionally after purchasing a product through home-shopping or online.

### A Product damage caused by customer's fault

Product damage caused by customer's mishandling or wrong repair

If a product damage is caused by;

- External impact or drop.
- Use of supplies or separately sold product unspecified by Samsung.
- Repair from a person besides an engineer of outsourcing service company or partner of Samsung Electronics Co., Ltd.
- Remodeling or repairing the product by customer.
- Using it with incorrect voltage or non-authorized electrical connections.
- Not following the "cautions" in User Manual.

#### Others

- If product fails by natural disaster. (lightning, fire, earthquake, flood damage, etc)
- If consumable components are all used up. (Battery, Toner, Fluorescent lights, Head, Vibrator, Lamp, Filter, Ribbon, etc.)
-  If customer requests a service in case the product has no defect, service fee may be charged. So please read User Manual first.

---

## Licence

---

### Open Source License Notice

Some software components of this product incorporate source code covered under the GNU General Public License (GPL), the GNU Lesser General Public License (LGPL) etc.

You may obtain the complete Corresponding Source code from us for a period of three years after our last shipment of this product.

If you want to obtain the complete Corresponding Source code in the physical medium such as CD-ROM, the cost of physically performing source distribution may be charged.

You may find a copy of the source at following website.

<http://opensource.samsung.com>

[http://software-dl.ti.com/processor-sdk-linux/esd/AM335X/latest/exports/software\\_manifest.htm](http://software-dl.ti.com/processor-sdk-linux/esd/AM335X/latest/exports/software_manifest.htm)

---



Dolby, Dolby Atmos, Dolby Audio and the double-D symbol are registered trademarks of Dolby Laboratories Licensing Corporation. Manufactured under license from Dolby Laboratories. Confidential unpublished works. Copyright © 2012-2021 Dolby Laboratories. All rights reserved.

---



The terms HDMI and HDMI High-Definition Multimedia Interface, and the HDMI Logo are trademarks or registered trademarks of HDMI Licensing Administrator, Inc. in the United States and other countries.

---