

E20513  
First Edition  
October 2022

**HDMI**™  
HIGH-DEFINITION MULTIMEDIA INTERFACE

ASUS ZenBeam™ E1R

# IN SEARCH OF INCREDIBLE



E-Manual

**ASUS**

## COPYRIGHT AND WARRANTY INFORMATION

No part of this manual, including the products and software described in it, may be reproduced, transmitted, transcribed, stored in a retrieval system, or translated into any language in any form or by any means, except documentation kept by the purchaser for backup purposes, without the express written permission of ASUSTeK COMPUTER INC. ("ASUS").

Product warranty or service will not be extended if: (1) the product is repaired, modified or altered, unless such repair, modification or alteration is authorized in writing by ASUS; or (2) the serial number of the is defaced or missing.

ASUS PROVIDES THIS MANUAL "AS IS" WITHOUT WARRANTY OF ANY KIND, EITHER EXPRESS OR IMPLIED, INCLUDING BUT NOT LIMITED TO THE IMPLIED WARRANTIES OR CONDITIONS OF MERCHANTABILITY OR FITNESS FOR A PARTICULAR PURPOSE. IN NO EVENT SHALL ASUS, ITS DIRECTORS, OFFICERS, EMPLOYEES OR AGENTS BE LIABLE FOR ANY INDIRECT, SPECIAL, INCIDENTAL, OR CONSEQUENTIAL DAMAGES (INCLUDING DAMAGES FOR LOSS OF PROFITS, LOSS OF BUSINESS, LOSS OF USE OR DATA, INTERRUPTION OF BUSINESS AND THE LIKE), EVEN IF ASUS HAS BEEN ADVISED OF THE POSSIBILITY OF SUCH DAMAGES ARISING FROM ANY DEFECT OR ERROR IN THIS MANUAL OR PRODUCT.

Products and corporate names appearing in this manual may or may not be registered trademarks or copyrights of their respective companies, and are used only for identification or explanation and to the owners' benefit, without intent to infringe.

SPECIFICATIONS AND INFORMATION CONTAINED IN THIS MANUAL ARE FURNISHED FOR INFORMATIONAL USE ONLY, AND ARE SUBJECT TO CHANGE AT ANY TIME WITHOUT NOTICE, AND SHOULD NOT BE CONSTRUED AS A COMMITMENT BY ASUS. ASUS ASSUMES NO RESPONSIBILITY OR LIABILITY FOR ANY ERRORS OR INACCURACIES THAT MAY APPEAR IN THIS MANUAL, INCLUDING THE PRODUCTS AND SOFTWARE DESCRIBED IN IT.

Copyright © 2022 ASUSTeK COMPUTER INC. All Rights Reserved.

## LIMITATION OF LIABILITY

Circumstances may arise where because of a default on ASUS' part or other liability, you are entitled to recover damages from ASUS. In each such instance, regardless of the basis on which you are entitled to claim damages from ASUS, ASUS is liable for no more than damages for bodily injury (including death) and damage to real property and tangible personal property; or any other actual and direct damages resulted from omission or failure of performing legal duties under this Warranty Statement, up to the listed contract price of each product.

ASUS will only be responsible for or indemnify you for loss, damages or claims based in contract, tort or infringement under this Warranty Statement.

This limit also applies to ASUS' suppliers and its reseller. It is the maximum for which ASUS, its suppliers, and your reseller are collectively responsible.

UNDER NO CIRCUMSTANCES IS ASUS LIABLE FOR ANY OF THE FOLLOWING: (1) THIRD-PARTY CLAIMS AGAINST YOU FOR DAMAGES; (2) LOSS OF, OR DAMAGE TO, YOUR RECORDS OR DATA; OR (3) SPECIAL, INCIDENTAL, OR INDIRECT DAMAGES OR FOR ANY ECONOMIC CONSEQUENTIAL DAMAGES (INCLUDING LOST PROFITS OR SAVINGS), EVEN IF ASUS, ITS SUPPLIERS OR YOUR RESELLER IS INFORMED OF THEIR POSSIBILITY.

## SERVICE AND SUPPORT

Visit our multi-language web site at <https://www.asus.com/support/>

# Table of Contents

About this manual .....	5
Conventions used in this manual .....	6
Typography.....	6
Multi-language versions .....	6
Safety precautions .....	7
Using your LED projector.....	7
Servicing and replacement of parts .....	7
Caring for your LED projector .....	8
Proper disposal.....	9

## Chapter 1: Getting to know your LED projector

Features .....	12
Top View.....	12
Extended features .....	15
Flashlight .....	15
SOS mode.....	16
Front View.....	17
Rear View .....	18
Right View .....	20
Bottom View .....	21

## Chapter 2: Setting up

Operating your LED projector .....	24
Connect the LED projector to the power adapter.....	24
AC power cord requirements .....	26
Use the correct AC plug type according to your current location....	26
Connect the LED projector to your device .....	27
Press the power button .....	28
Adjust focus .....	29
Portrait mode.....	30
Screen size and projection distance table.....	31

## **Chapter 3: Using the LED projector**

Using your LED projector for the first time .....	34
Operating the onscreen display menu .....	35
Using Wi-Fi connection (for selected models only) .....	36
Wireless Mirroring .....	37
Streaming .....	39
Using USB connection .....	40
Streaming .....	40
Onscreen display menu options .....	41
Volume .....	41
Input .....	41
Splendid .....	41
Brightness .....	41
Contrast .....	42
Keystone .....	42
Projector Position .....	42
Setup .....	43
Information .....	44
Turning off your LED projector .....	45

## **Appendices**

Federal Communications Commission Statement .....	48
Canadian Department of Communications Statement .....	49
Global Environmental Regulation Compliance and Declaration ...	50
ASUS Recycling/Takeback Services .....	50
HDMI Connectivity .....	51
Supported PC Timings .....	52
Specifications for E1R LED projector .....	54

# About this manual

This manual provides information about the hardware and software features of your LED projector through the following chapters:

## **Chapter 1: Getting to know your LED Projector**

This chapter details the parts of your LED projector.

## **Chapter 2: Setting up**

This chapter shows you how to set up your LED projector and use its parts for input device connection.

## **Chapter 3: Using the LED projector**

This chapter describes the features of the LED projector's control panel buttons and how to use them to launch the functions of your LED projector.

## **Appendices**

This section includes safety notices for your LED projector.

## Conventions used in this manual

To highlight key information in this manual, some text are presented as follows:

---

**IMPORTANT!** This message contains vital information that must be followed to complete a task.

---

---

**NOTE:** This message contains additional information and tips that can help complete tasks.

---

---

**WARNING!** This message contains important information that must be followed to keep you safe while performing tasks and prevent damage to your LED projector's data and components.

---

## Typography

**Bold** indicates a menu or an item that must be selected.

*Italic* indicates sections that you can refer to in this manual.

## Multi-language versions

Download other language versions of this E-Manual via this website:

**<https://www.asus.com/support/>**

# Safety precautions

## Using your LED projector

- Refer to the manual and take note of the safety instructions before operating your LED projector.
- Follow the notes and warnings stated in the user manual.
- DO NOT place your LED projector on uneven or unstable surfaces.
- DO NOT use your LED projector in smoky environments. Smoke residue may cause build-up on critical parts and damage the LED projector or decrease its performance.
- DO NOT use damaged power cords, accessories, and other peripherals with your LED projector.
- Keep the LED projector's plastic packages out of the reach of children.
- DO NOT block or place anything near the LED projector's ventilation holes. Doing so may cause internal heat build-up that can degrade picture quality and damage the projector.
- Ensure that the operating voltage of your LED projector matches the voltage of your power source.

## Servicing and replacement of parts

- DO NOT disassemble or attempt to service this LED projector by yourself. Contact your local ASUS service center for assistance.
- Risk of explosion if battery is replaced by an incorrect type. Dispose used batteries according to safety instructions and contact your local ASUS service center for assistance.
- When replacing parts of your LED projector, purchase items as specified by ASUS and contact your local service center for assistance.

## Caring for your LED projector

- Switch off then unplug the LED projector from the power outlet before cleaning it.
- When cleaning the LED projector's housing, use a clean soft cloth dampened with water or a mix of water and neutral detergent. Wipe it dry using a soft dry cloth.
- Ensure that the lens is cool before cleaning it. Gently wipe the lens using a lens cleaning paper. DO NOT touch the lens with your hands.
- DO NOT use liquid or aerosole cleaners, benzene, or thinners on your LED projector.
- Never operate this LED projector immediately after moving it from a cold location. When the LED projector is exposed to a drastic change in temperature, moisture may condense on the lens and its other internal parts. To prevent this, use the unit two (2) hours after an extreme or sudden change in temperature occurs.
- DO NOT use a spray containing flammable gases to clean the lens. This may cause a fire due to excessive heat inside the projector.
- DO NOT clean the lens while the projector is warming up as this may cause the lens' surface film to peel off.
- DO NOT use a hard object to wipe or tap the lens.

## Safety Precautions

Accessories that came with this product have been designed and verified for the use in connection with this product. Never use accessories for other products to prevent the risk of electric shock or fire.

## 安全上のご注意

付属品は当該専用品です。他の機器には使用しないでください。機器の破損もしくは、火災や感電の原因となることがあります。



## Proper disposal



DO NOT throw your LED projector in municipal waste. This product has been designed to enable proper reuse of parts and recycling. The symbol of the crossed out wheeled bin indicates that the product (electrical, electronic equipment and mercury-containing button cell battery) should not be placed in municipal waste. Check local regulations for disposal of electronic products.



DO NOT throw the battery in municipal waste. The symbol of the crossed out wheeled bin indicates that the battery should not be placed in municipal waste.



# ***Chapter 1: Getting to know your LED projector***

# Features

## Top View

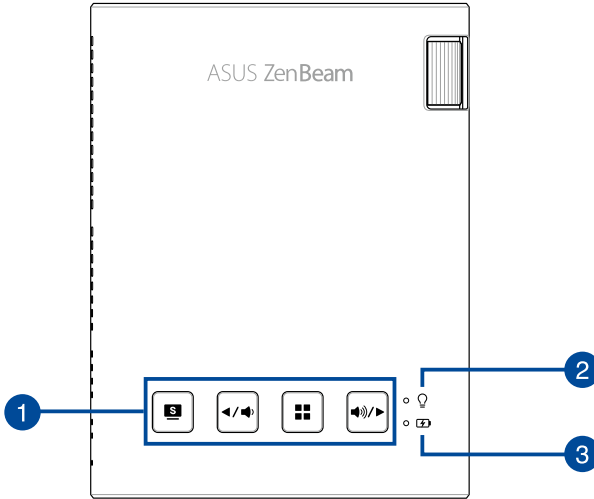

### 1 Control panel buttons

The control panel buttons allow you to navigate the onscreen display menu. Individually, these buttons also correspond to a specific LED projector setting as indicated below.



Splendid/Exit



Left/Decrease volume



Menu/OK



Right/Increase volume

---

**NOTE:** For more information on using the control panel buttons to access your LED projector's settings, refer to *Chapter 3: Using the LED projector*.

---

## 2 Power indicator and battery status indicator

This LED indicator indicates the following scenarios for your LED projector:

- It lights up when the LED projector is powered on.
- It lights up as either green or red depending on the battery charge status.

For details on how this LED indicator functions as a battery status indicator, refer to the following table:

Color	Status
<b>Solid Green</b>	The LED projector is plugged to a power source, running in battery mode and the battery power is more than 25%, or running in power bank mode.
<b>Solid Red</b>	The LED projector is running in battery mode only and the battery power is not more than 25%.
<b>Blinking Orange</b>	The temperature of the LED projector is too high and will lower its brightness automatically. The LED projector will shut down if the temperature is still too high to prevent overheating.
<b>Blinking Green</b>	The LED projector is currently used as a power bank and charging your mobile device.

### 3 Battery charge indicator

This LED indicator lights up when the LED projector is plugged to a power source using its power adapter.

---

**IMPORTANT!** Use only the bundled power adapter to charge the battery pack and supply power to your LED projector.

---

## Extended features

Your LED projector also have stand-alone features that are launched by pressing  while your LED projector is in battery mode.

---

### NOTE:

- These features are not available when your LED projector is connected to an HDMI input source or in Wi-Fi mode.
- To turn off or switch between the flashlight and emergency light feature of your LED projector, just press  until your preferred lighting feature is disabled or enabled.

---

**IMPORTANT!** Make sure that your LED projector is charged and can run in battery mode before enabling these features. Battery time varies depending on usage.

---

## Flashlight

The LED projector flashes a steady white light when you use this feature.

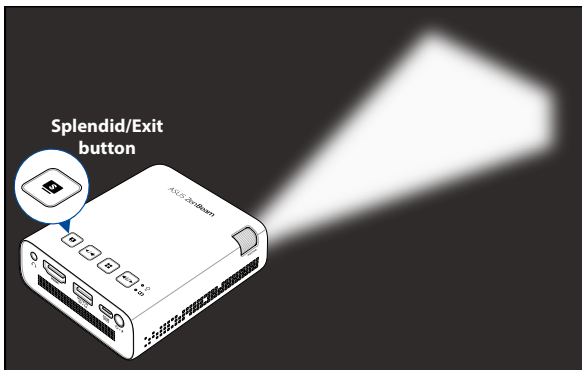

To use your LED projector as a flashlight:

1. Disconnect all peripherals and the Wi-Fi dongle from your LED projector, and then press the power button to turn it on.

2. Press  repeatedly until the LED projector flashes a steady white light.

## SOS mode

The LED projector flashes a blinking white light when you use this feature.

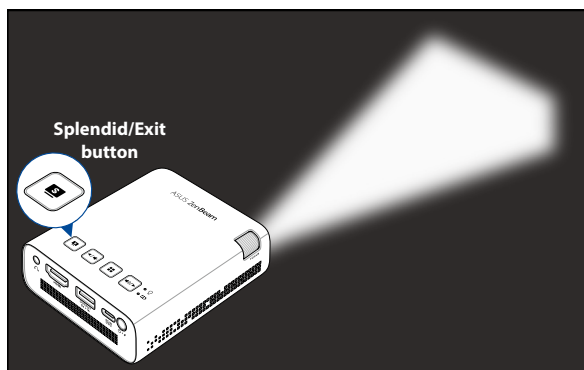

To use your LED projector as an emergency light:

1. Disconnect all peripherals and the Wi-Fi dongle from your LED projector, and then press the power button to turn it on.
2. Press  repeatedly until the LED projector flashes a blinking white light.



## Front View

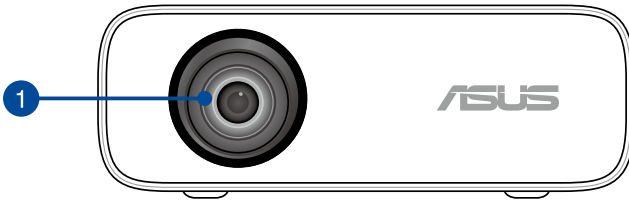

### 1 Lens

The lens projects video or image files onscreen from your input device.

---

#### **WARNING!**

- DO NOT touch the lens with your hands or any sharp object.
  - DO NOT look directly into the lens.
-

## Rear View

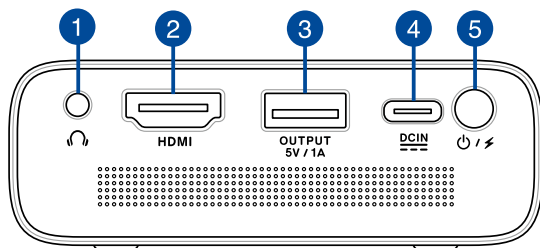

### 1 Audio output jack port

The audio output jack port allows you to connect your LED projector to headphones.

### 2 HDMI port

This port is for the HDMI (High-Definition Multimedia Interface) connectors. These port are HDCP compliant for HD DVD, Blu-ray, and other protected content playback.

### 3 Power output/Wi-Fi dongle port

This power output port provides up to 5V/1A of output voltage and current. You can connect your mobile device to this port to keep it charged while using it with your LED projector.

You can also insert a Wi-Fi dongle (bundled with selected models) that allows you to mirror or stream content from your mobile device.

---

**NOTE:** For more details, refer to the *Using Wi-Fi connection* section in this manual.

---

#### 4 Power (DC) input port

Insert the bundled power adapter into this port to charge the battery pack and supply power to your LED projector.

---

**IMPORTANT!** Use only the bundled power adapter to charge the battery pack and supply power to your LED projector.

---

---

**WARNING!** The adapter may become warm to hot while in use. DO NOT cover the adapter and keep it away from your body while it is connected to a power source.

---

#### 5 Power button

Long press this power button to turn on or turn off your LED projector. Short press this button to turn on or turn off power bank mode.

## Right View

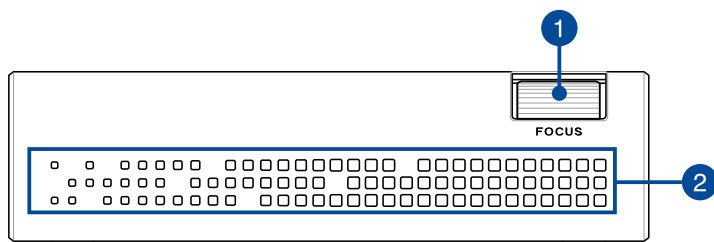

### 1 Focus dial

The focus ring allows you to adjust the image focus of your LED projector.

### 2 Air vents

The air vents allow cool air to enter and warm air to exit the LED projector.

---

**WARNING!** Ensure that paper, books, clothing, cables, or other objects do not block any of the air vents or else overheating may occur.

---

## Bottom View

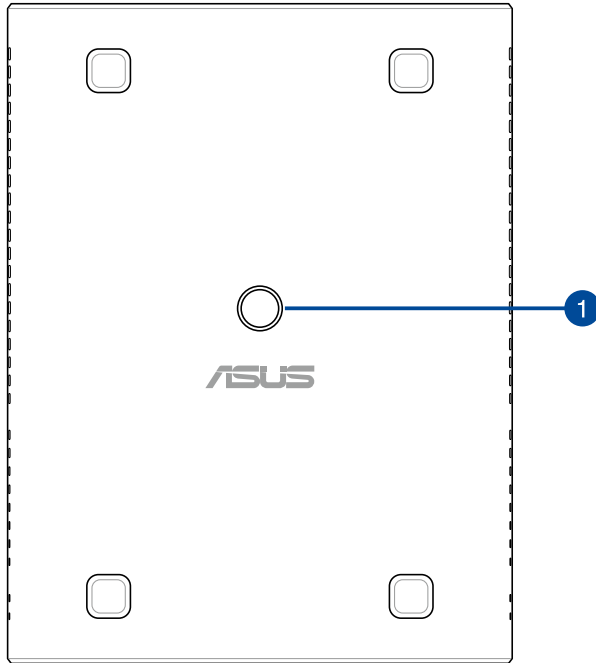

### 1 Tripod socket

Attach the LED projector to a tripod with a 1/4-20UNC mounting screw using this socket.

---

**NOTE:** This socket should only be used with tripods that are less than 1 meter in height.

---



# ***Chapter 2: Setting up***

# Operating your LED projector

This portable LED projector allows you to plug and play your devices so you can easily open multimedia files and hear audio straight from its built-in SonicMaster speakers.

For your safety and to maintain the quality of this unit, refer to the following steps when operating your LED projector.

## Connect the LED projector to the power adapter

- A. Connect the power cord to the AC power adapter.
- B. Plug the AC power adapter into a 100V~240V power source.
- C. Connect the DC power connector to your LED projector.



Charge the LED projector for **5 hours** before using it in battery mode for the first time.

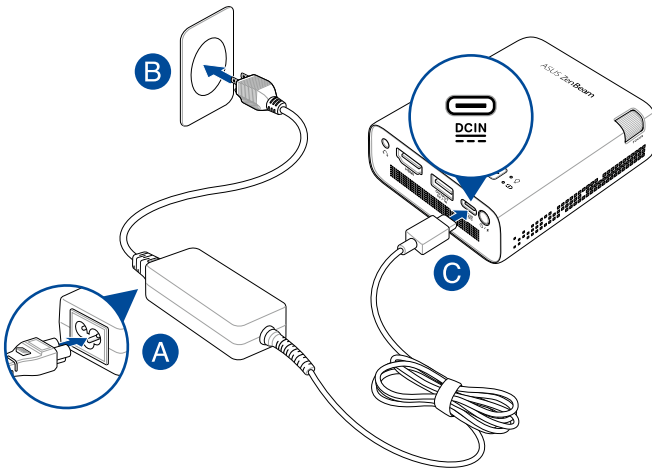

---

**NOTE:** The power adapter may vary in appearance, depending on model and region.

---



---

**IMPORTANT!**

- Use only the bundled power adapter to charge the battery pack and supply power to your LED projector.
  - Make sure that your LED projector is connected to the power adapter before turning it on for the first time. Always plug the power cord into a wall socket without using extension cords. For your safety, connect this device to a properly grounded electrical outlet only.
  - The socket outlet must be easily accessible and near your LED projector.
  - To disconnect your LED projector from its main power supply, unplug your LED projector from the power socket.
- 

**WARNING!**

Read the following precautions for your LED projector's battery:

- The battery capacity will vary depending on the environment temperature, humidity, and LED Projector usage.
  - The battery used in this device may present a risk of fire or chemical burn if removed or disassembled.
  - Follow the warning labels for your personal safety.
  - Risk of explosion if battery is replaced by an incorrect type.
  - DO NOT dispose of in fire.
  - Never attempt to short-circuit your LED projector's battery.
  - Never attempt to disassemble and reassemble the battery.
  - Discontinue usage if leakage is found.
  - The battery and its components must be recycled or disposed of properly.
  - Keep the battery and other small components away from children.
  - Disposal of a battery into fire or a hot oven, or mechanically crushing or cutting of a battery, that can result in an explosion;
  - Leaving a battery in an extremely high temperature surrounding environment that can result in an explosion or the leakage of flammable liquid or gas;
  - A battery subjected to extremely low air pressure that may result in an explosion or the leakage of flammable liquid or gas.
-

## AC power cord requirements

Use the correct AC plug type according to your current location.

---

**IMPORTANT!** Contact your sales dealer if the AC power cord bundled with your LED projector does not match your local power source.

---

**NOTE:** We highly recommend that you use a video source device that also uses a grounding type plug to prevent signal interference due to voltage fluctuations.

---

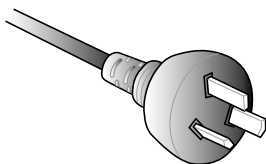

For Australia and Mainland China

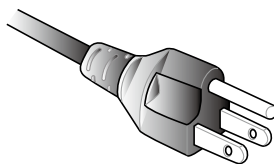

For USA, Canada, Japan, and Taiwan

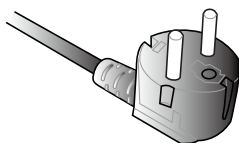

For Continental Europe

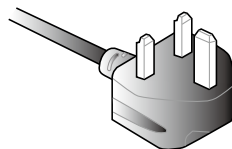

For UK

## Connect the LED projector to your device

### A Audio output

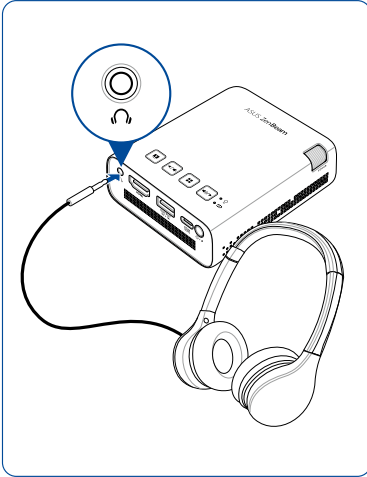

### B HDMI

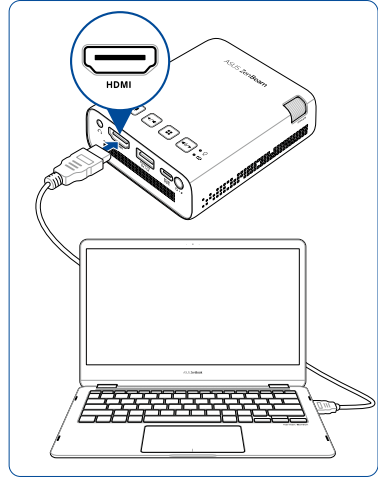

### C Power output (5V/1A)

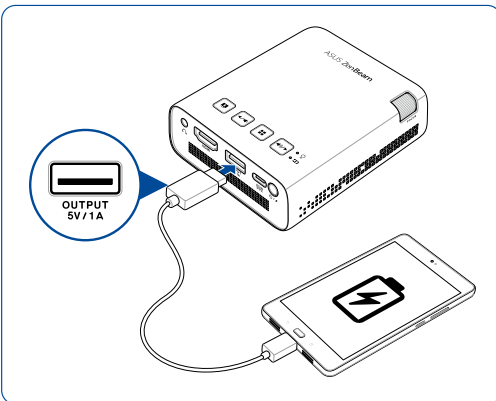

## Press the power button

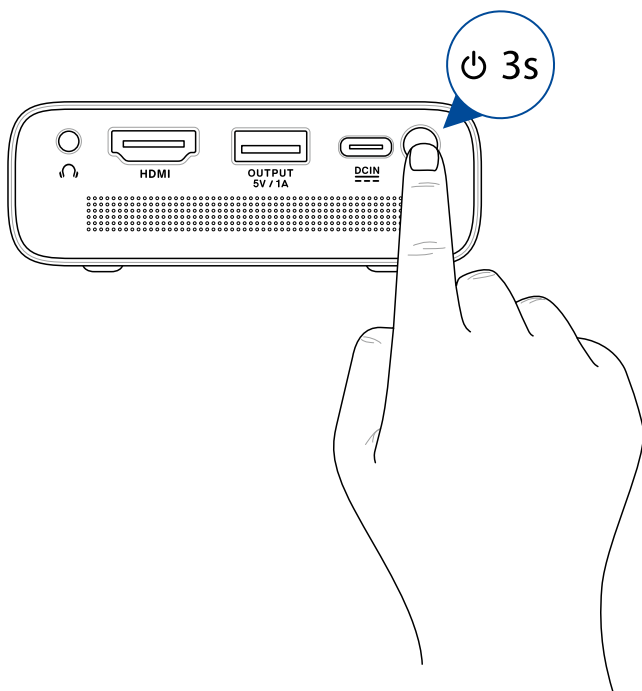

---

**NOTE:** The battery pack inside your LED projector stops charging while the LED projector is in use. Refer to the battery indicator for the current charge status of your LED projector. You may also refer to the *Top View* section in this manual for more details.

---

## Adjust focus

---

**NOTE:** Use a still image when adjusting the onscreen display.

---

Adjust the image focus of the projection onscreen by moving the focus dial up or down.



## Portrait mode

Your LED projector supports both landscape (standard) and portrait modes. To use the portrait mode, rotate the projector to a vertical position, and the vertical image can be viewed in full screen without black bars on the sides.

---

**NOTE:** Your LED projector allows you to mirror or stream content from your mobile device, refer to the *Using Wi-Fi connection* section in this manual for more details.

---

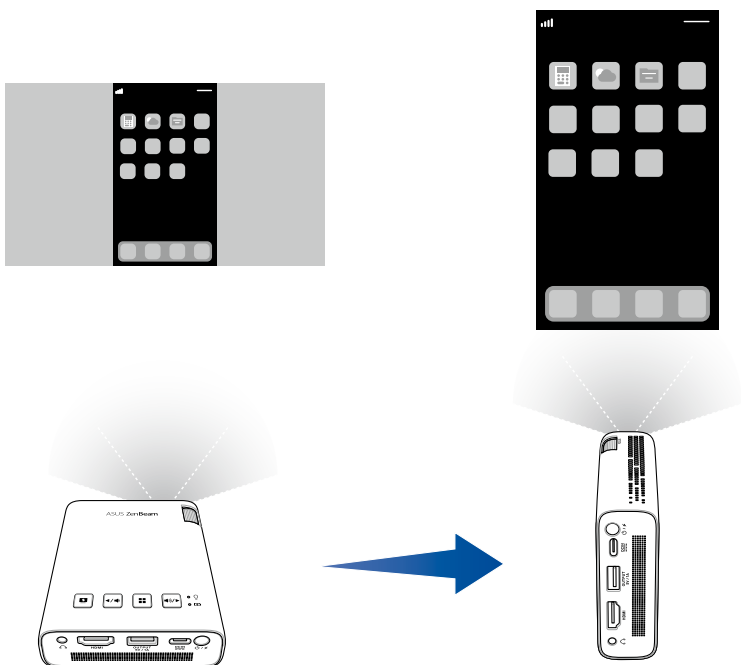

## Screen size and projection distance table

Adjust the LED projector's distance from the screen using the table below.

Screen Size						Projection Distance	
Diagonal		Horizontal		Vertical			
inch	mm	inch	mm	inch	mm	inch	mm
30	762	26.14	664	14.72	374	31.29	795
40	1016	34.88	886	19.60	498	41.77	1061
50	1270	43.58	1107	24.52	623	52.24	1327
60	1524	52.28	1328	29.40	747	62.71	1593
70	1778	61	1550	34.33	872	73.07	1856
80	2032	69.72	1771	39.21	996	83.54	2122
90	2286	78.42	1992	44.13	1121	94.05	2389
100	2540	87.12	2213	49.05	1246	104.48	2654
110	2794	95.86	2435	53.93	1370	114.96	2920
120	3048	104.56	2656	58.85	1495	125.39	3185





# ***Chapter 3: Using the LED projector***

# Using your LED projector for the first time

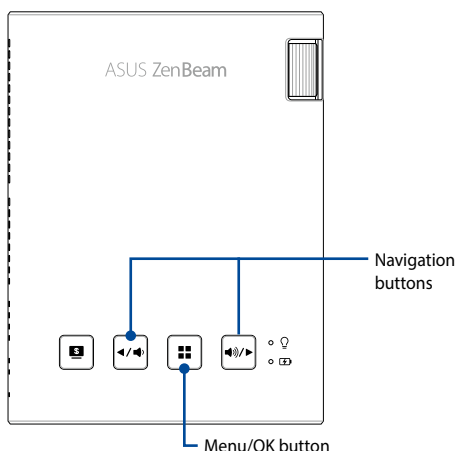



Refer to the following steps when using your LED projector for the first time.



---

**NOTE:** Ensure that your LED projector is connected to the power adapter before turning it on for the first time. We strongly recommend that you use a grounded wall socket while using your LED projector on power adapter mode.

---

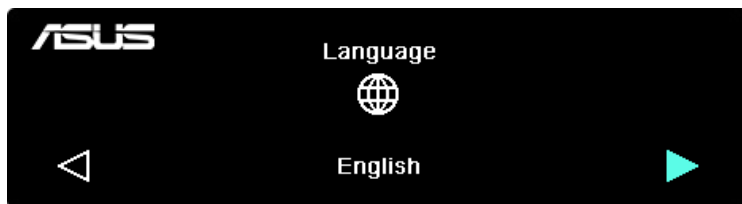
1. Set up your LED projector then press and hold the power button for three (3) seconds to turn it on.
2. Press  or  on your LED projector's control panel to browse through the available language options.



3. After you have chosen your preferred language, press  to set this language for use on your LED projector.
4. You may now start using your LED projector to display files from your input device. The **NO SIGNAL** screen may appear if no input device is connected or cannot be detected by the LED projector.
5. Press  on your LED projector's control panel to launch its onscreen display menu.

## Operating the onscreen display menu

Your LED projector is a plug-and-play device that also features an onscreen display menu that contains a set of programs and settings that can maximize your use of the LED projector.





Launch the onscreen display menu by pressing  on the control panel of your LED projector.



---

**NOTE:** For more details, refer to the *Onscreen display menu options* section in this manual.

---

To scroll through the options on the onscreen display menu, press the navigation buttons ( / ) on your LED projector's control panel. After adjusting the settings, press  to save the new settings and press  to go back to the home screen.



## Using Wi-Fi connection (for selected models only)

The optional Wi-Fi dongle allows you to project your device's screen or stream from your device to your LED projector. The setup process may differ slightly from device to device.

Make sure to do the following before starting screen mirroring or media streaming from your device:

1. Insert the Wi-Fi dongle into your LED projector's USB Type-A port.
2. You should automatically be switched to wireless projection mode.

---

**NOTE:** If you are not automatically switched to wireless projection mode, you can change it through the OSD. Press  and then select  > Mirroring.

---

3. Turn on Wi-Fi on your device.

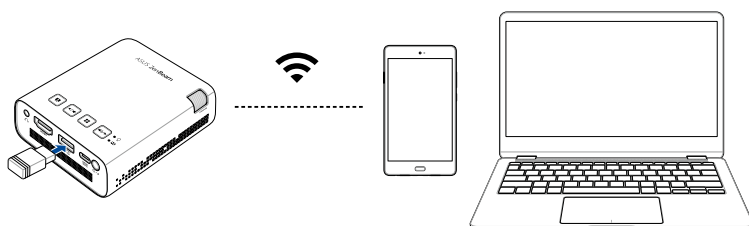

## Wireless Mirroring

---

### NOTE:

- The option names may vary depending on device. For more information, refer to the manual supplied with your device.
  - Ensure your mobile operating system is up to date before you start the mirroring or streaming process.
- 



### From Android devices

1. Tap **Smart Mirroring** or **Cast** and connect to your LED projector's SSID as shown on the projection screen.
2. Begin projecting your mobile device's screen to the LED projector.

### From iOS devices

1. Turn on Wi-Fi and select your LED projector's SSID (as shown on the projection screen) from the network list.
2. Enter the projector password (as shown on the projection screen) to connect.
3. Tap **Screen Mirroring** and connect to your LED projector's SSID as shown on the projection screen.
4. Begin projecting your mobile device's screen to the LED projector.

## From Windows laptop

1. Press the shortcut Windows Key (  or  ) + K.
2. Select your LED projector's SSID (as shown on the projection screen) from the device list.
3. Enter the projector password (as shown on the projection screen) to connect and start mirroring.

## From MacBook

1. Select your LED projector's SSID (as shown on the projection screen) from the Wi-Fi list on your MacBook.
2. Enter the projector password (as shown on the projection screen) to connect.
3. Open your browser and type the URL (<http://192.168.xxx.xxx>) as shown on the projection screen in the address bar. You will be directed to a web page to connect your LED projector to the Wi-Fi network.

---

### NOTE:

- Make sure that your device and LED projector are connected to the same Wi-Fi network before you continue to the next step.
  - To connect to a different Wi-Fi network, repeat step 3 and select the Wi-Fi network you prefer on the web page.
- 

4. Open Control Center on your Mac and select **Screen Mirroring**. From the device list, select your LED projector to start mirroring.

Scan the QR code to watch the instructional video:



---

**NOTE:** Your projector may look different from the one in the video, but the interface and the steps to follow are the same.

---

# Streaming

## Streaming from YouTube or Facebook video

### Standard settings

1. Turn on Wi-Fi and select your LED projector's SSID (as shown on the projection screen) from the network list.
2. Enter the projector password (as shown on the projection screen) to connect.
3. Open your browser and type the URL (<http://192.168.xxx.xxx>) as shown on the projection screen in the address bar. You will be directed to a web page to connect your LED projector to the Wi-Fi network.

---

#### NOTE:

- Ensure your device and LED projector are connected to the same Wi-Fi network before you continue to the next step.
  - To connect to a different Wi-Fi network, repeat step 3 and select the Wi-Fi network you prefer on the web page.
- 

4. Open the YouTube or Facebook app, then tap the **Cast** button  on the video screen. From the device list, select your LED projector to stream to.
5. Once connected, select the video you wish to watch and tap **Play**. Your content will start playing from the projector.

Scan the QR code to watch the instructional video:



---

**NOTE:** Your projector may look different from the one in the video, but the interface and the steps to follow are the same.

---

## Using USB connection

The USB Type-A port allows you to project your device's screen or stream from your device to your LED projector. The setup process may differ slightly from device to device.

Make sure that the USB cable is inserted correctly into your LED projector before starting screen mirroring or media streaming from your device.

### Streaming

#### From an Android phone

1. Connect the other end of the USB cable to your phone.
2. Download and install MiraPlug on your phone.
3. Open MiraPlug and tap **Cast**.

#### From an iOS phone

1. Connect the other end of the USB cable to your phone.
2. Tap **Trust** when asked to confirm that you want to allow your LED projector access to your phone.

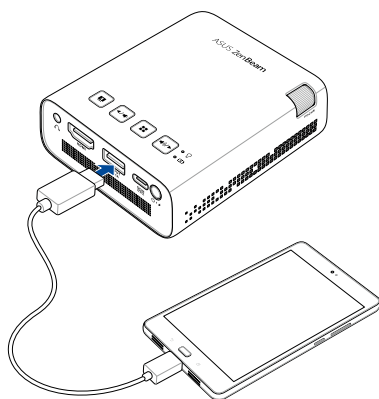





## Onscreen display menu options

You may refer to the following pages for details on each of the onscreen display menu options.

### Volume

Select this menu option to adjust the volume of the audio file played on your LED projector.

You may adjust the volume on a scale of **0** to **10**, and you may also press and hold  or  to quickly mute or adjust the volume to the loudest.

### Input

Select this menu option to configure the input source for your LED projector.

### Splendid

Select this menu option to activate different display modes. You may also directly launch this menu option by pressing .

Available options: **Bright**, **Standard**, **Theater**, and **ECO**

### Brightness

Select this menu option to adjust the brightness of your projection on screen. You may adjust the brightness on a scale of **0** to **10**, from darkest to brightest.

## Contrast

Select this menu option to adjust the light and dark areas of your projection on screen. You may adjust the contrast on a scale of **0** to **10**, from the lowest to the highest possible color contrast.

## Keystone

Select this option to adjust the keystone of your projection onscreen.

---

**NOTE:** If you wish to enable the Auto Keystone feature after manual adjustment, go to **Setup** and turn on **Auto Keystone**.

---

## Projector Position

This option allows you to change the way your projections are oriented on screen based from the current location of your LED projector.

You may change your projection's orientation to correspond with the location where your LED projector is currently placed: **Front Table** and **Rear Table**.

## Setup

Select this menu option to configure the following settings of your LED projector:

- **Language** - This option allows you to set the LED projector's onscreen display menu to other languages.
- **Reset** - This option restores the default settings of your LED projector or Wi-Fi network.
- **Auto Keystone** - This option allows you to enable or disable auto keystone correction.
- **Auto Ceiling Detection** - This option allows you to enable or disable auto ceiling detection.
- **Auto Power** - This option allows you to enable or disable the auto power on feature when your LED projector is connected to an HDMI device and plugged to a power source using its power adapter.
- **OSD Timeout** - This option allows you to set the number of seconds before the onscreen display menu disappears from your projection screen.
- **Power Timeout** - This option allows you to select **Auto** (15 minutes) or set the number of minutes with no HDMI signal before your LED projector shut down automatically.

## Information

Select this menu option to see an overview of information about your LED projector.

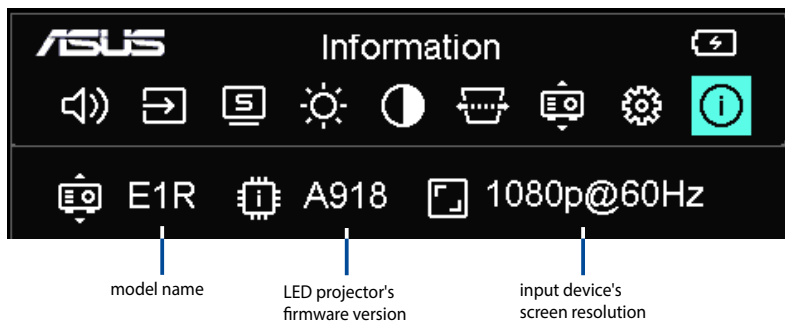

# Turning off your LED projector

1. Press the power button.

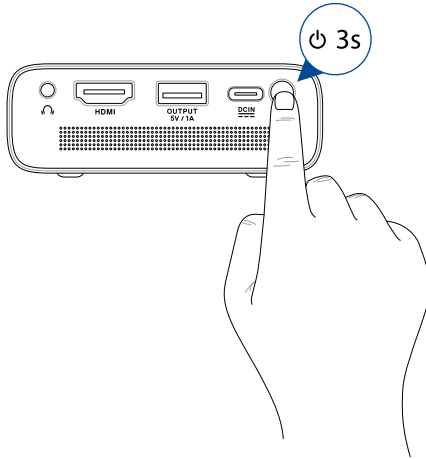

2. When the following screen appears, press the power button again to completely turn off your LED projector. If you need to turn on your LED projector again immediately after turning it off, please wait until the Power indicator and battery status indicator lights off.





# ***Appendices***

# Federal Communications Commission Statement

Responsible Party: Asus Computer International  
Address: 48720 Kato Rd., Fremont, CA 94538, USA  
Phone / Fax No: (510)739-3777 / (510)608-4555  
Product name: LED projector  
Model: E1R

This equipment has been tested and found to comply with the limits for a class B digital device, pursuant to Part 15 of the Federal Communications Commission (FCC) rules. These limits are designed to provide reasonable protection against harmful interference in a residential installation. This equipment generates, uses, and can radiate radio frequency energy and, if not installed and used in accordance with the instructions, may cause harmful interference to radio communications. However, there is no guarantee that interference will not occur in a particular installation. If this equipment does cause harmful interference to radio or television reception, which can be determined by turning the equipment off and on, the user is encouraged to try to correct the interference by one or more of the following measures:

- Reorient or relocate the receiving antenna.
- Increase the distance between the equipment and receiver.
- Connect the equipment to an outlet on a different circuit than that which the receiver is connected to.
- Consult the dealer or an experienced radio/TV technician for help.

This device complies with Part 15 of the FCC Rules. Operation is subject to the following two conditions:

1. This device may not cause harmful interference, and
2. This device must accept any interference that may cause undesired operation.



## **Canadian Department of Communications Statement**

This digital apparatus does not exceed the Class B limits for radio noise emissions from digital apparatus set out in the Radio Interference Regulations of the Canadian Department of Communications.

This class B digital apparatus complies with Canadian ICES-003.

# Global Environmental Regulation Compliance and Declaration

ASUS follows the green design concept to design and manufacture our products, and makes sure that each stage of the product life cycle of ASUS product is in line with global environmental regulations. In addition, ASUS disclose the relevant information based on regulation requirements.

Please refer to <http://csr.asus.com/english/Compliance.htm> for information disclosure based on regulation requirements ASUS is complied with:

## Japan JIS-C-0950 Material Declarations

### EU REACH SVHC

### Korea RoHS

## ASUS Recycling/Takeback Services

ASUS recycling and takeback programs come from our commitment to the highest standards for protecting our environment. We believe in providing solutions for you to be able to responsibly recycle our products, batteries, other components as well as the packaging materials. Please go to <http://csr.asus.com/english/Takeback.htm> for detailed recycling information in different regions.

# HDMI Connectivity

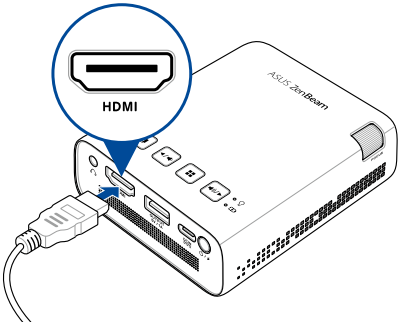

	<p>Devices with HDMI port</p>	<ul style="list-style-type: none"> <li>• HDMI to HDMI Cable</li> </ul>
	<p>Devices with micro HDMI port</p>	<ul style="list-style-type: none"> <li>• Micro HDMI to HDMI Adapter</li> <li>• HDMI to HDMI Cable</li> </ul>
	<p>iOS devices with Lightning™ port</p>	<ul style="list-style-type: none"> <li>• Lightning™ Digital AV Adapter</li> <li>• HDMI to HDMI Cable</li> </ul>
	<p>Devices with USB 3.2 Gen 2 Type-C® port</p>	<ul style="list-style-type: none"> <li>• USB 3.2 Gen 2 Type-C® Digital AV Adapter</li> <li>• HDMI to HDMI Cable</li> </ul>

# Supported PC Timings

## HDMI (PC)

Mode	Resolution	Refresh rate (Hz)	H-frequency (kHz)	Clock (MHz)
VGA	640x480	60.0	31.5	25.175
VGA	640x480	66.9	33.2	23.900
720x480_60	720x480	60.0	29.7	23.700
720x576_50	720x576	50.0	29.5	23.600
832x624_75	832x624	74.9	25.4	23.100
XGA	1024x768	60.0	48.3	65.000
XGA	1024x768	75.0	60.0	78.750
XGA	1024x768	60.0	65.0	65.000
720p	1280x720	60.0	45.0	74.250
720p	1280x720	50.0	36.8	50.000
WXGA	1280x800	60.0	49.7	83.500
SXGA	1280x1024	60.0	64.0	108.000
UXGA	1600x900	60.0	55.5	93.250
SVGA	800x600	60.0	37.9	40.000
WXGA+	1440x900	60.0	55.9	106.500
WSXGA+	1680x1050	60.0	65.3	146.250
1080p	1920x1080	60.0	67.5	148.500
PowerBook G4	1024x768	60.0	48.4	65.000
MAC13	640x480	66.7	35.0	30.240
MAC16	832x624	74.5	49.7	57.280
MAC19	1024x768	75.0	60.2	80.000
MAC21	1152x870	75.0	68.7	100.000
MAC21	1152x864	60.0	53.3	65.600

## HDMI (Video)

Timing	Resolution	V-frequency (Hz)	H-frequency (kHz)	Dot Clock Frequency (MHz)
480i	720x480 (1440x480)16:9	59.94 (29.97)	15.7	27.000
576i	720x576 (1440x576)16:9	50 (25)	15.6	27.000
480p	720x480 16:9	59.9	31.5	27.000
576p	720x576 16:9	50.0	31.3	27.000
720p	1280x720	60.0	45.0	74.250
720p	1280x720	50.0	37.5	74.250
1080i	1920x1080	60 (30)	33.8	74.250
1080i	1920x1080	50 (25)	28.1	74.250
1080p	1920x1080	23.97/24	27.0	74.250
1080p	1920x1080	60.0	67.5	145.500
1080p	1920x1080	50.0	56.3	145.500
1080p	1920x1080	25.0	28.1	74.250
1080p	1920x1080	30.0	33.8	74.250
Graphic source monitor range limits	Horizontal scan rate: 15k-75kHz			
	Vertical scan rate: 24-60Hz			
	Max. pixel rate: 170MHz (digital)			

# Specifications for E1R LED projector

<b>Display</b>	Display Technology	0.2" DLP®
	Light Source	R/G/B LED
	Light Source Life	20,000 hrs
	True Resolution (native)	WVGA 854 x 480
	Light Output	200 LED Lumens
	Contrast Ratio (typical)	500:1
	Color Saturation (NTSC)	100%
	Display Colors	16.7 million colors
<b>Projection Lens</b>	Throw Ratio	1.2:1 (37.6 in. @1 m @16:9)
	Projection Distance	0.5 m to 3.0 m
	Projection/Screen Size	19 in to 110 in
	Projection Offset	100%
	Zoom Ratio	Fixed
<b>Video Features</b>	Picture Modes	Bright, Standard, Theater, ECO
	Keystone Adjustment	Vertical ±40°
	Auto Keystone	Yes
	Projector Placement	Front Table, Rear Table
<b>Audio Features</b>	Built-in speakers	2W speaker (ASUS SonicMaster Audio technology)

*(continued on the next page)*

<b>Signal Frequency</b>	<b>Digital Signal Frequency</b>	24.7 KHz(H) to 74.6 KHz(H) / 50 Hz(V) to 60 Hz(V)
<b>Power</b>	<b>Power On Mode</b>	≤45 W
	<b>Standby Mode</b>	<0.5 W
<b>Battery</b>	<b>Internal Battery</b>	2850mAh (5V@1A)
	<b>Battery Life</b>	Up to 4 hours
<b>Noise</b>	<b>Acoustic Noise</b>	30 dB (Standard mode)
		28 dB (Theater mode)
<b>Input / Output</b>	<b>PC Signal Input</b>	HDMI 1.4b
	<b>Audio Out</b>	Earphone out
	<b>USB 2.0 port for power output</b>	Yes (5V@1A)
<b>Mechanical Design</b>	<b>Chassis Colors</b>	Silver
	<b>Tripod Socket</b>	Yes
	<b>On-machine Buttons</b>	Yes
	<b>Lens Cover</b>	No
<b>Dimension</b>	<b>Physical Dimension</b>	108 mm x 84 mm x 29 mm (L x W x H)
<b>Weight</b>	<b>Net Weight (Esti.)</b>	310 g

*(continued on the next page)*

<b>Operating Temperature</b>	0° C to 35° C
<b>Operating Humidity</b>	20% to 90%
<b>Accessories</b>	Soft Protective Case, Drawstring Bag, HDMI Cable, Quick Start Guide, Warranty Card  <b>For Select Models Only</b> Dongle, Power Cord, USB Cable,
<b>Regulation Approvals</b>	FCC / CE / CB / RCM / VCCI / IEC62471 / CEC

---

**NOTE:**

- Specifications are subject to change without prior notice.
  - Product availability may vary by region.
  - All brand and product names mentioned are trademarks of their respective companies.
-