



Digital Projector User Manual

LW730 / LH730

V 1.00

Warranty and Copyright information

Limited warranty

BenQ warrants this product against any defects in material and workmanship, under normal usage and storage.

Proof of purchase date will be required with any warranty claim. In the event this product is found to be defective within the warranty period, BenQ's only obligation and your exclusive remedy shall be replacement of any defective parts (labor included). To obtain warranty service, immediately notify the dealer from which you purchased the product of any defects.

Important: The above warranty shall be void if the customer fails to operate the product in accordance with BenQ's written instructions, especially the ambient humidity must be in-between 10% and 90%, temperature in-between 0°C and 35°C, altitude lower than 4920 feet, and avoiding to operate the projector in a dusty environment. This warranty gives you specific legal rights, and you may have other rights which vary from country to country.

For other information, please visit www.BenQ.com.

Copyright

Copyright © 2022 by BenQ Corporation. All rights reserved. No part of this publication may be reproduced, transmitted, transcribed, stored in a retrieval system or translated into any language or computer language, in any form or by any means, electronic, mechanical, magnetic, optical, chemical, manual or otherwise, without the prior written permission of BenQ Corporation.

Disclaimer

BenQ Corporation makes no representations or warranties, either expressed or implied, with respect to the contents hereof and specifically disclaims any warranties, merchantability or fitness for any particular purpose. Further, BenQ Corporation reserves the right to revise this publication and to make changes from time to time in the contents hereof without obligation to notify any person of such revision or changes.

*DLP, Digital Micromirror Device and DMD are trademarks of Texas Instruments. Others are copyrights of their respective companies or organizations.

Patents

Please go to <http://patmarking.benq.com/> for the details on BenQ projector patent coverage.

Table of Contents

Warranty and Copyright information	2
Important safety instructions	4
Introduction	7
Shipping contents	7
Projector exterior view	8
Controls and functions	9
Positioning your projector	11
Choosing a location	11
Obtaining a preferred projected image size	12
Mounting the projector	16
Adjusting the projected image	17
Connection	19
Operation	22
Starting up the projector	22
Using the menus	23
Securing the projector	24
Switching input signal	25
Connecting the projector to the Internet	26
Shutting down the projector	27
Menu operation	28
Basic Menu	28
Advanced Menu	29
Maintenance	47
Care of the projector	47
Light source information	47
Troubleshooting	50
Specifications	51
Projector specifications	51
Dimensions	52
Timing chart	53

Important safety instructions

Your projector is designed and tested to meet the latest standards for safety of information technology equipment. However, to ensure safe use of this product, it is important that you follow the instructions mentioned in this manual and marked on the product.

1. **Please read this manual before you operate your projector.** Save it for future reference.

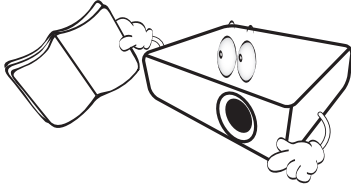

2. **Do not look straight at the projector lens during operation.** The intense light beam may damage your eyes.

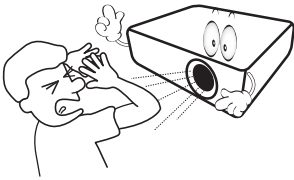

3. **Refer servicing to qualified service personnel.**

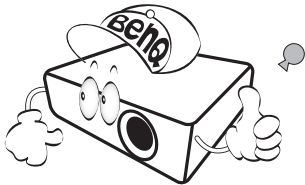

4. **Always open the lens shutter (if any) or remove the lens cap (if any) when the projector light source is on.**

5. The light source becomes extremely hot during operation.

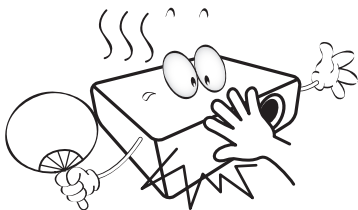

6. In some countries, the line voltage is NOT stable. This projector is designed to operate safely within a mains voltage between 100 to 240 volts AC, but could fail if power cuts or surges of ± 10 volts occur. **In areas where the mains voltage may fluctuate or cut out, it is recommended that you connect your projector through a power stabilizer, surge protector or uninterruptible power supply (UPS).**

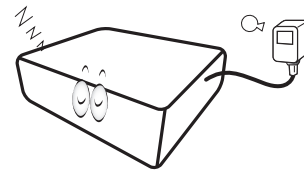

7. Do not block the projection lens with any objects when the projector is under operation as this could cause the objects to become heated and deformed or even cause a fire. To temporarily turn off the light source, use the blank function.

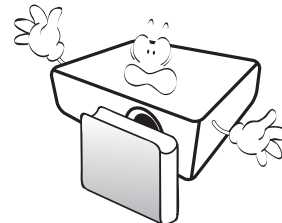

8. Do not operate light sources beyond the rated light source life.

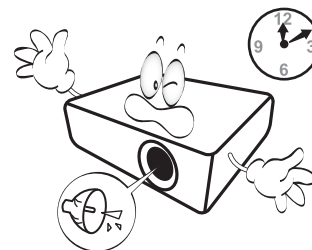

9. Do not place this product on an unstable cart, stand, or table. The product may fall, sustaining serious damage.

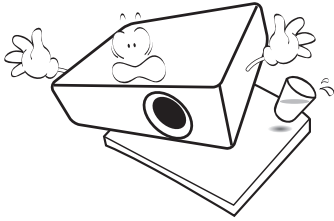

10. Do not attempt to disassemble this projector. There are dangerous high voltages inside which may cause death if you should come into contact with live parts.

Under no circumstances should you ever undo or remove any other covers. Refer servicing only to suitably qualified professional service personnel.

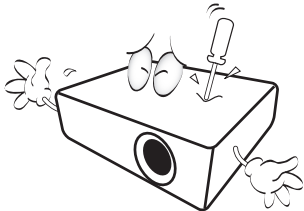

11. Do not block the ventilation holes.

- Do not place this projector on a blanket, bedding or any other soft surface.
- Do not cover this projector with a cloth or any other item.
- Do not place inflammables near the projector.

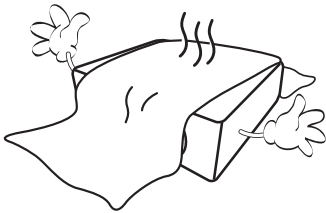

If the ventilation holes are seriously obstructed, overheating inside the projector may result in a fire.

12. Always place the projector on a level, horizontal surface during operation.

- Do not use if tilted at an angle of more than 10 degrees left to right, nor at angle of more than 15 degrees front to back. Using the projector when it is not fully horizontal may cause a malfunction of, or damage to, the light source.

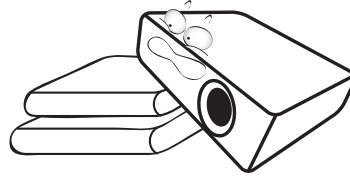

13. Do not stand the projector on end vertically. Doing so may cause the projector to fall over, causing injury or resulting in damage to the projector.

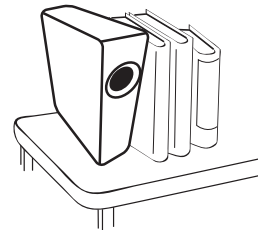

14. Do not step on the projector or place any objects upon it. Besides probable physical damage to the projector, doing so may result in accidents and possible injury.

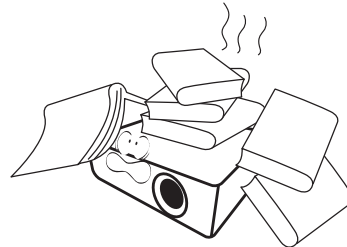

15. When the projector is under operation, you may sense some heated air and odor from its ventilation grill. It is a normal phenomenon and not a product defect.

16. Do not place liquids near or on the projector. Liquids spilled into the projector may cause it to fail. If the projector does become wet, disconnect it from the power supply's power outlet and call BenQ to have the projector serviced.

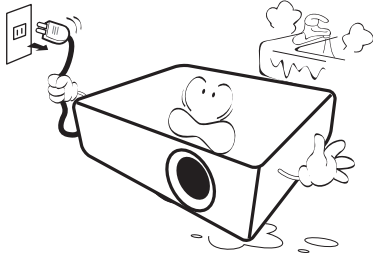

17. This product is capable of displaying inverted images for ceiling/wall mount installation.

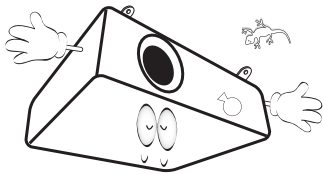

18. This apparatus must be earthed.

19. Do not place this projector in any of the following environments.

- Space that is poorly ventilated or confined. Allow at least 50 cm clearance from walls and free flow of air around the projector.
- Locations where temperatures may become excessively high, such as the inside of a car with all windows rolled up.
- Locations where excessive humidity, dust, or cigarette smoke may contaminate optical components, shorten the projector's life span and darken the image.

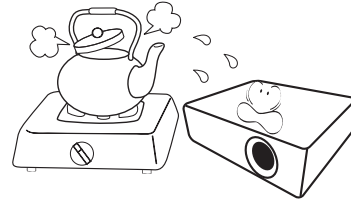

- Locations near fire alarms
- Locations with an ambient temperature above 40°C / 104°F
- Locations where the altitudes are higher than 3000 m (10000 feet).

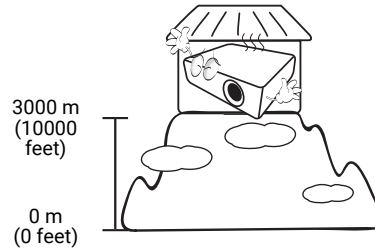

Risk Group 2

1. According to the classification of photobiological safety of light sources and light source systems, this product is Risk Group 2, IEC 62471-5:2015.
2. Possibly hazardous optical radiation emitted from this product.
3. Do not stare at operating light source. May be harmful to the eyes.
4. As with any bright source, do not stare into the direct beam.



! To avoid damaging the DLP chips, never aim a high-power laser beam into the projection lens.

Introduction

Shipping contents

Carefully unpack and verify that you have all of the items shown below. If any of these items are missing, please contact your place of purchase.

Standard accessories

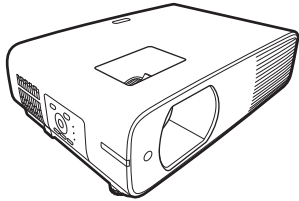

Projector

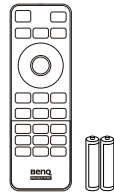

Remote control with
batteries

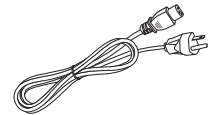

Power cord



Quick start guide



Warranty card*

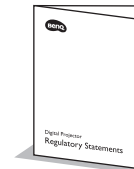

Regulatory statements



- The supplied accessories will be suitable for your region, and may differ from those illustrated.
- *The warranty card is only supplied in some specific regions. Please consult your dealer for detailed information.

Optional accessories

- Wireless Dongle (EZC5201BS) (for **LH730**)

Replacing the remote control batteries

1. Press and open the battery cover, as illustrated.
2. Remove the old batteries (if applicable) and install two AAA batteries. Make sure that the positive and negative ends are positioned correctly, as illustrated.
3. Replace the battery cover until it clicks into place.

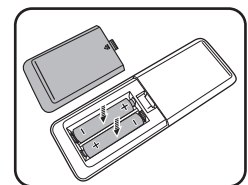
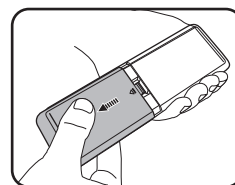

- Avoid leaving the remote control and batteries in an excessive heat or humid environment like the kitchen, bathroom, sauna, sunroom or in a closed car.
- Replace only with the same or equivalent type recommended by the battery manufacturer.
- Dispose of the used batteries according to the manufacturer's instructions and local environment regulations for your region.
- Never throw the batteries into a fire. There may be danger of an explosion.
- If the batteries are dead or if you will not be using the remote control for an extended period of time, remove the batteries to avoid damage to the remote control from possible battery leakage.

Projector exterior view

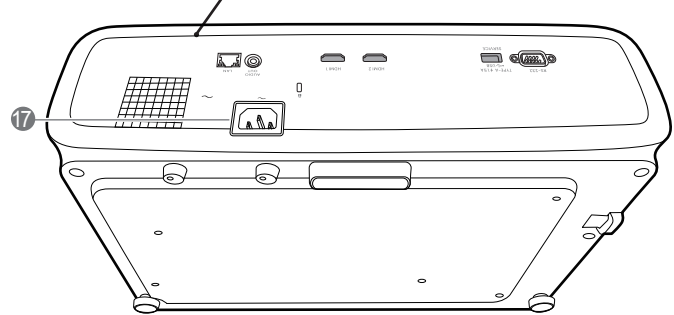
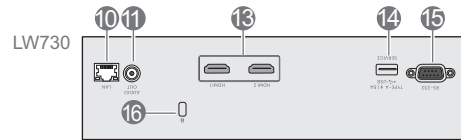
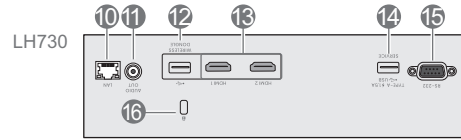
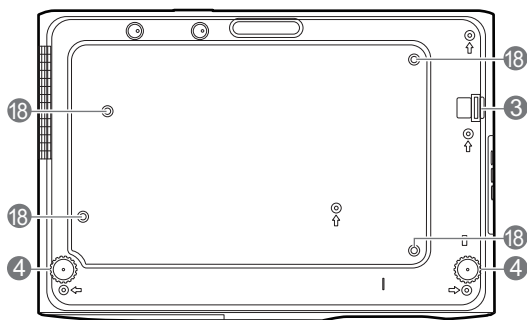
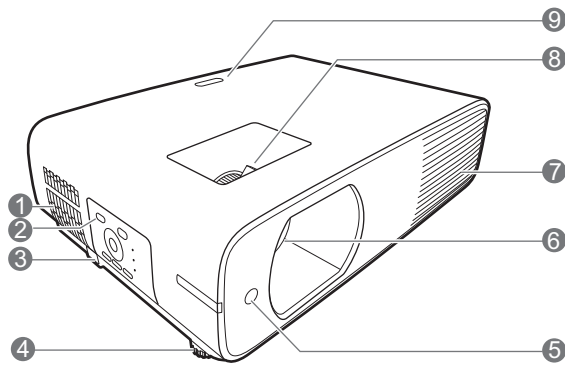

1. Vent (air inlet)
2. External control panel
(See [Controls and functions on page 9.](#))
3. Security bar
4. Adjuster feet
5. IR remote sensor
6. Projection lens
7. Vent (air exhaust)
8. Focus ring and Zoom ring
9. IR remote sensor

10. RJ-45 LAN input jack
11. Audio output jack
12. USB Type A port (for WiFi dongle)
13. HDMI input ports
14. USB Type A port (5V/1.5A power supply)
15. RS-232 control port
16. Kensington anti-theft lock slot
17. AC power jack
18. Ceiling/Wall mount holes

Controls and functions

Projector & Remote control



All the key presses described in this document are available on the remote control or projector.

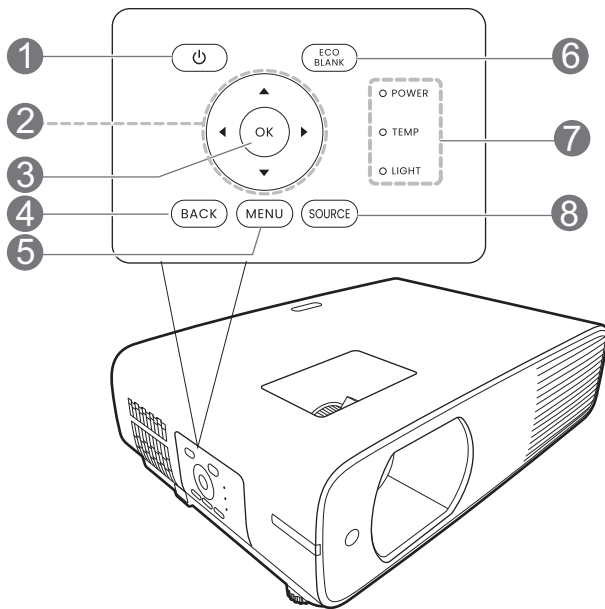



1. **POWER**

Toggles the projector between standby mode and on.

 **ON** /  **Off**

Toggles the projector between standby mode and on.

2. **Arrow keys**

Keystone keys (, )

Displays the keystone correction page.

Arrow keys (, , , )

When the On-Screen Display (OSD) menu is activated, these keys are used as directional arrows to select the desired menu items and to make adjustments.

3. **OK**

Selects an available picture setup mode. When the On-Screen Display (OSD) menu is activated, confirms the selected On-Screen Display (OSD) menu item.

4. **BACK**

Goes back to previous OSD menu, exits and saves menu settings.

5. **MENU**

Turns on or closes the On-Screen Display (OSD) menu.

6. **ECO BLANK**

Used to hide the screen picture.



Do not block the projection lens from projecting as this could cause the blocking object to become heated and deformed or even cause a fire.

7. **POWER indicator light/TEMPerature warning light/LIGHT indicator light**
(See [Indicators on page 49.](#))
8. **SOURCE**
Displays the source selection bar.
9. Source selection button: **PC 1**
No function.
10. Source selection button: **HDMI**
Selects **HDMI 1** input source for display.
11. **PAGE▲/PAGE▼**
Operate your display software program (on a connected PC) which responds to page up/down commands (like Microsoft PowerPoint).
12. **SMART ECO**
Displays the **Light Source Mode** menu for selecting a suitable light source operating mode.
13. **AUTO**
No function.
14. **FREEZE**
Freezes the projected image.
15. **ASPECT**
Selects the display aspect ratio.
16. Volume keys **◀- / ▶+**
Decreases or increase the projector volume.
17. **ZOOM+/ZOOM-**
Magnifies or reduces the projected picture size.
18. **QUICK INSTALL**
Quickly selects several functions to adjust the projected image and displays the test pattern.
19. **MUTE** **🔇**
Toggles projector audio between on and off.

Remote control effective range

The remote control must be held at an angle within 30 degrees perpendicular to the projector's IR remote control sensor(s) to function correctly. The distance between the remote control and the sensor(s) should not exceed 8 meters (~ 26 feet).

Make sure that there are no obstacles between the remote control and the IR sensor(s) on the projector that might obstruct the infra-red beam.

- Operating the projector from the front

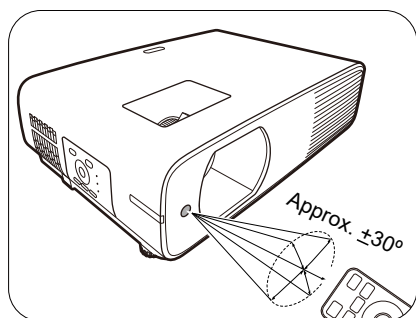

- Operating the projector from the top

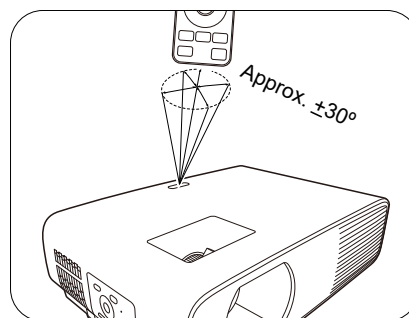

Positioning your projector

Choosing a location

Before choosing an installation location for your projector, take the following factors into consideration:

- Size and position of your screen
- Electrical outlet location
- Location and distance between the projector and the rest of your equipment

You can install your projector in the following ways.

1. Front

Select this location with the projector placed on the table in front of the screen. This is the most common way to position the projector for quick setup and portability.

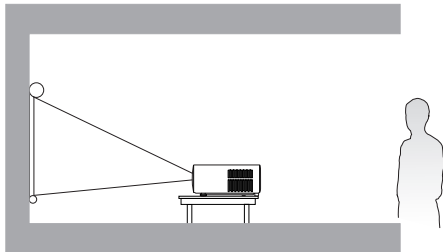

2. Rear

Select this location with the projector placed on the table behind the screen. Note that a special rear projection screen is required.

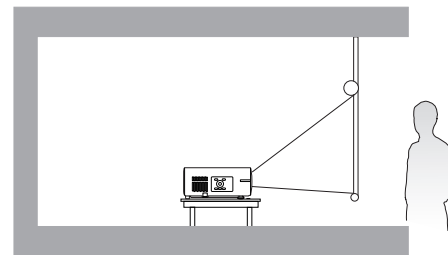

3. Front Ceiling

Select this location with the projector suspended upside-down in front of the screen. Purchase the BenQ Projector Ceiling/Wall Mount Kit from your dealer to mount your projector.

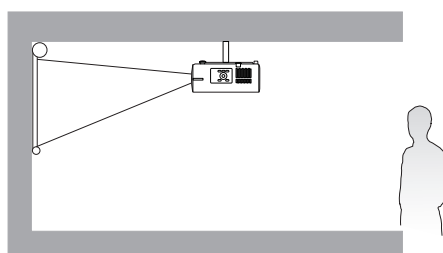

4. Rear Ceiling

Select this location with the projector suspended upside-down from behind the screen. Note that a special rear projection screen and the BenQ Projector Ceiling/Wall Mount Kit are required for this installation location.

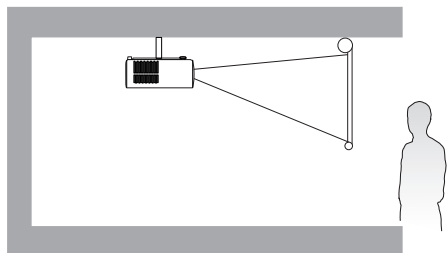

After turning on the projector, go to **Advanced Menu - Installation > Projector Position** and press ◀/▶ to select a setting.

You can also use **QUICK INSTALL** on the remote control to access this menu.

Obtaining a preferred projected image size

The distance from the projector lens to the screen, the zoom setting (if available), and the video format each factors in the projected image size.

Projection dimensions

- The screen aspect ratio is 16:10 and the projected picture is in a 16:10 aspect ratio

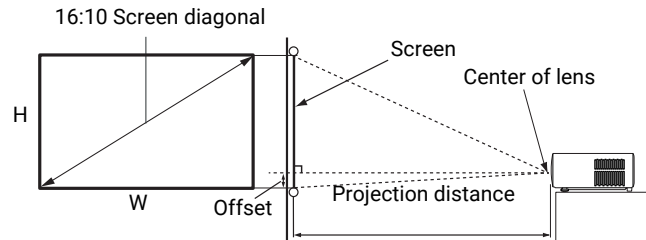

LW730

Screen size				Projection distance (mm)			Offset (mm)
Diagonal		W (mm)	H (mm)	Min distance (with max zoom)	Average	Max distance (with min zoom)	
Inch	mm						
30	762	646	404	885	974	1062	-42
40	1016	862	538	1180	1298	1416	-57
50	1270	1077	673	1475	1623	1771	-71
60	1524	1292	808	1771	1948	2125	-85
70	1778	1508	942	2066	2272	2479	-99
80	2032	1723	1077	2361	2597	2833	-113
87	2210	1874	1171	2567	2824	3081	-123
100	2540	2154	1346	2951	3246	3541	-141
110	2794	2369	1481	3246	3571	3895	-155
120	3048	2585	1615	3541	3895	4249	-170
130	3302	2800	1750	3836	4220	4603	-184
140	3556	3015	1885	4131	4544	4957	-198
150	3810	3231	2019	4426	4869	5312	-212
160	4064	3446	2154	4721	5194	5666	-226
170	4318	3662	2289	5016	5518	6020	-240
180	4572	3877	2423	5312	5843	6374	-254
190	4826	4092	2558	5607	6167	6728	-269
200	5080	4308	2692	5902	6492	7082	-283
210	5334	4523	2827	6197	6816	7436	-297
220	5588	4739	2962	6492	7141	7790	-311
230	5842	4954	3096	6787	7466	8144	-325
240	6096	5169	3231	7082	7790	8498	-339
250	6350	5385	3365	7377	8115	8853	-353
260	6604	5600	3500	7672	8439	9207	-368
270	6858	5816	3635	7967	8764	9561	-382
280	7112	6031	3769	8262	9089	9915	-396
290	7366	6246	3904	8558	9413	10269	-410
300	7620	6462	4039	8853	9738	10623	-424

For example, if you are using a 120-inch screen, the recommended projection distance is 3895 mm.

If your measured projection distance is 4200 mm, the closest match in the "[Projection distance \(mm\)](#)" column is 4220 mm. Looking across this row shows that a 130" (about 3.3 m) screen is required.



To optimize your projection quality, we suggest doing the projection by referring to the values listed in the non-gray rows.



All measurements are approximate and may vary from the actual sizes.

BenQ recommends that if you intend to permanently install the projector, you should physically test the projection size and distance using the actual projector in situ before you permanently install it, so as to make allowance for this projector's optical characteristics. This will help you determine the exact mounting position so that it best suits your installation location.

LH730

- The screen aspect ratio is 16:9 and the projected picture is in a 16:9 aspect ratio

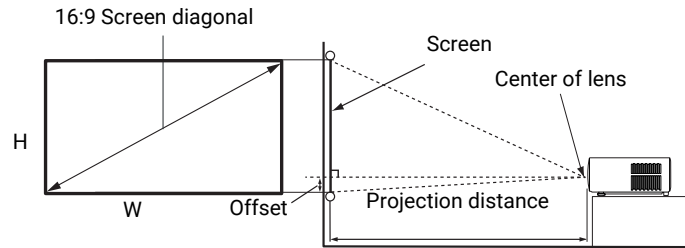

Screen size				Projection distance (mm)			Offset (mm)
Diagonal		W (mm)	H (mm)	Min distance (with max zoom)	Average	Max distance (with min zoom)	
Inch	mm						
30	762	664	374	863	950	1036	-31
40	1016	886	498	1151	1266	1381	-41
50	1270	1107	623	1439	1583	1727	-52
60	1524	1328	747	1727	1899	2072	-62
70	1778	1550	872	2015	2216	2417	-72
80	2032	1771	996	2302	2533	2763	-83
90	2286	1992	1121	2590	2849	3108	-93
100	2540	2214	1245	2878	3166	3454	-103
110	2794	2435	1370	3166	3482	3799	-114
120	3048	2657	1494	3454	3799	4144	-124
130	3302	2878	1619	3741	4115	4490	-134
140	3556	3099	1743	4029	4432	4835	-145
150	3810	3321	1868	4317	4749	5180	-155
160	4064	3542	1992	4605	5065	5526	-165
170	4318	3763	2117	4893	5382	5871	-176
180	4572	3985	2241	5180	5698	6216	-186
190	4826	4206	2366	5468	6015	6562	-196
200	5080	4428	2491	5756	6331	6907	-207
210	5334	4649	2615	6044	6648	7252	-217
220	5588	4870	2740	6331	6965	7598	-227
230	5842	5092	2864	6619	7281	7943	-238
240	6096	5313	2989	6907	7598	8288	-248
250	6350	5535	3113	7195	7914	8634	-258
260	6604	5756	3238	7483	8231	8979	-269
270	6858	5977	3362	7770	8547	9325	-279
280	7112	6199	3487	8058	8864	9670	-289
290	7366	6420	3611	8346	9181	10015	-300
300	7620	6641	3736	8634	9497	10361	-310

For example, if you are using a 120-inch screen, the recommended projection distance is 3799 mm.

If your measured projection distance is 3000 mm, the closest match in the "[Projection distance \(mm\)](#)" column is 3166 mm. Looking across this row shows that a 100" (about 2.5 m) screen is required.



To optimize your projection quality, we suggest doing the projection by referring to the values listed in the non-gray rows.



All measurements are approximate and may vary from the actual sizes.

BenQ recommends that if you intend to permanently install the projector, you should physically test the projection size and distance using the actual projector in situ before you permanently install it, so as to make allowance for this projector's optical characteristics. This will help you determine the exact mounting position so that it best suits your installation location.

Mounting the projector

If you intend to mount your projector, we strongly recommend that you use a proper fitting BenQ projector mounting kit and that you ensure it is securely and safely installed.

If you use a non-BenQ brand projector mounting kit, there is a safety risk that the projector may fall down due to an improper attachment through the use of the wrong gauge or length screws.

Before mounting the projector

- Purchase a BenQ projector mounting kit from the place you purchased your BenQ projector.
- BenQ recommends that you also purchase a separate Kensington lock compatible security cable and attach it securely to both the Kensington lock slot on the projector and the base of the mounting bracket. This will perform the secondary role of restraining the projector should its attachment to the mounting bracket become loose.
- Ask your dealer to install the projector for you. Installing the projector on your own may cause it to fall and result in injury.
- Take necessary procedures to prevent the projector from falling off such as during an earthquake.
- The warranty doesn't cover any product damage caused by mounting the projector with a non-BenQ brand projector mounting kit.
- Consider the surrounding temperature where the projector is ceiling/wall mounted. If a heater is used, the temperature around the ceiling/wall may be higher than expected.
- Read the user manual for the mounting kit about the range of torque. Tightening with torque exceeding the recommended range may cause damage to the projector and subsequently falling off.
- Make sure the power outlet is at an accessible height so that you can easily shut down the projector.

Ceiling/Wall mount installation diagram

Ceiling/Wall mount screw: M4 * 8L

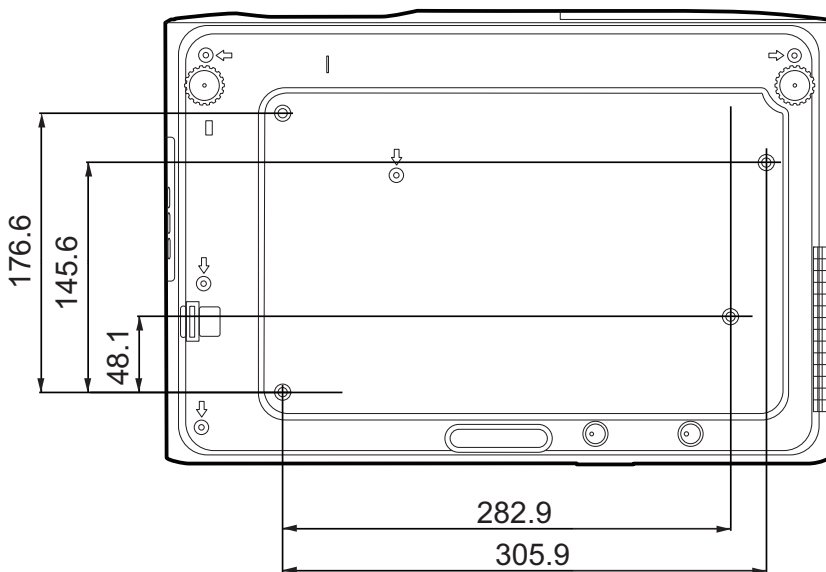

Unit: mm

Adjusting the projected image

Adjusting the projection angle

If the projector is not placed on a flat surface or the screen and the projector are not perpendicular to each other, the projected image becomes trapezoidal. You can screw the adjuster feet to fine-tune the horizontal angle.

To retract the feet, screw the adjuster feet in a reverse direction.

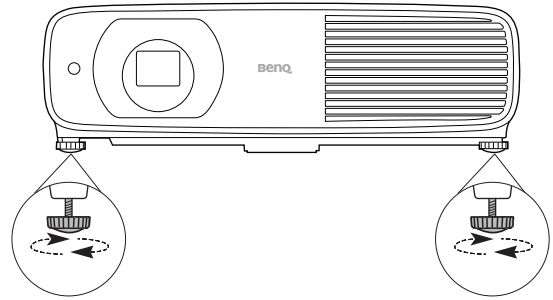

Do not look into the lens while the light source is on. The strong light from the light source may cause damage to your eyes.

Fine-tuning the image size and clarity

Adjust the projected image to the size that you need using the zoom ring. Sharpen the image by rotating the focus ring.

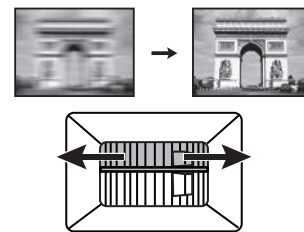
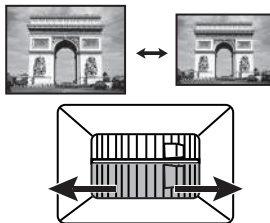

Correcting keystone

Keystoning refers to the situation where the projected image becomes a trapezoid due to angled projection.

To correct this, besides adjusting the height of the projector, if you want the projector to automatically correct image keystone, be sure the **Auto Vertical Keystone** function in the **Advanced Menu - Installation** menu is **On**.

Or you will need to manually correct it following these steps.

1. Do one of the following steps to display the keystone correction page.
 - Press ▲/▼.
 - Press **QUICK INSTALL** on the remote control. Press ▼ to highlight **2D Keystone** and press **OK**.
 - Go to **Advanced Menu - Installation > 2D Keystone** and press **OK**.

2. After the **2D Keystone** correction page displays. To correct keystone at the top of the image, use ▼. To correct keystone at the bottom of the image, use ▲. To correct keystone at the right side of the image, use ◀. To correct keystone at the left side of the image, use ▶.

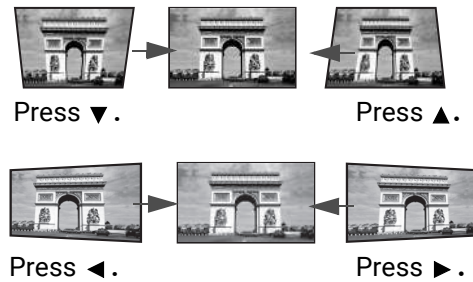

Adjusting Corner Fit

You can manually adjust four corners of the image by setting the horizontal and vertical values.

1. Do one of the following steps to display the keystone correction page.
 - Press **QUICK INSTALL** on the remote control. Press ▼ to highlight **Corner Fit** and press **OK**.
 - Go to **Advanced** menu - **Installation** > **Corner Fit** and press **OK**.
2. Press ▲/▼/◀/▶ to select one corner and press **OK**.
3. Press ▲/▼ to adjust vertical values.
4. Press ◀/▶ to adjust horizontal values.

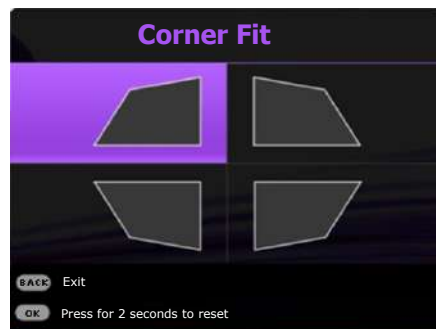

Connection

When connecting a signal source to the projector, be sure to:

1. Turn all equipment off before making any connections.
2. Use the correct signal cables for each source.
3. Ensure the cables are firmly inserted.

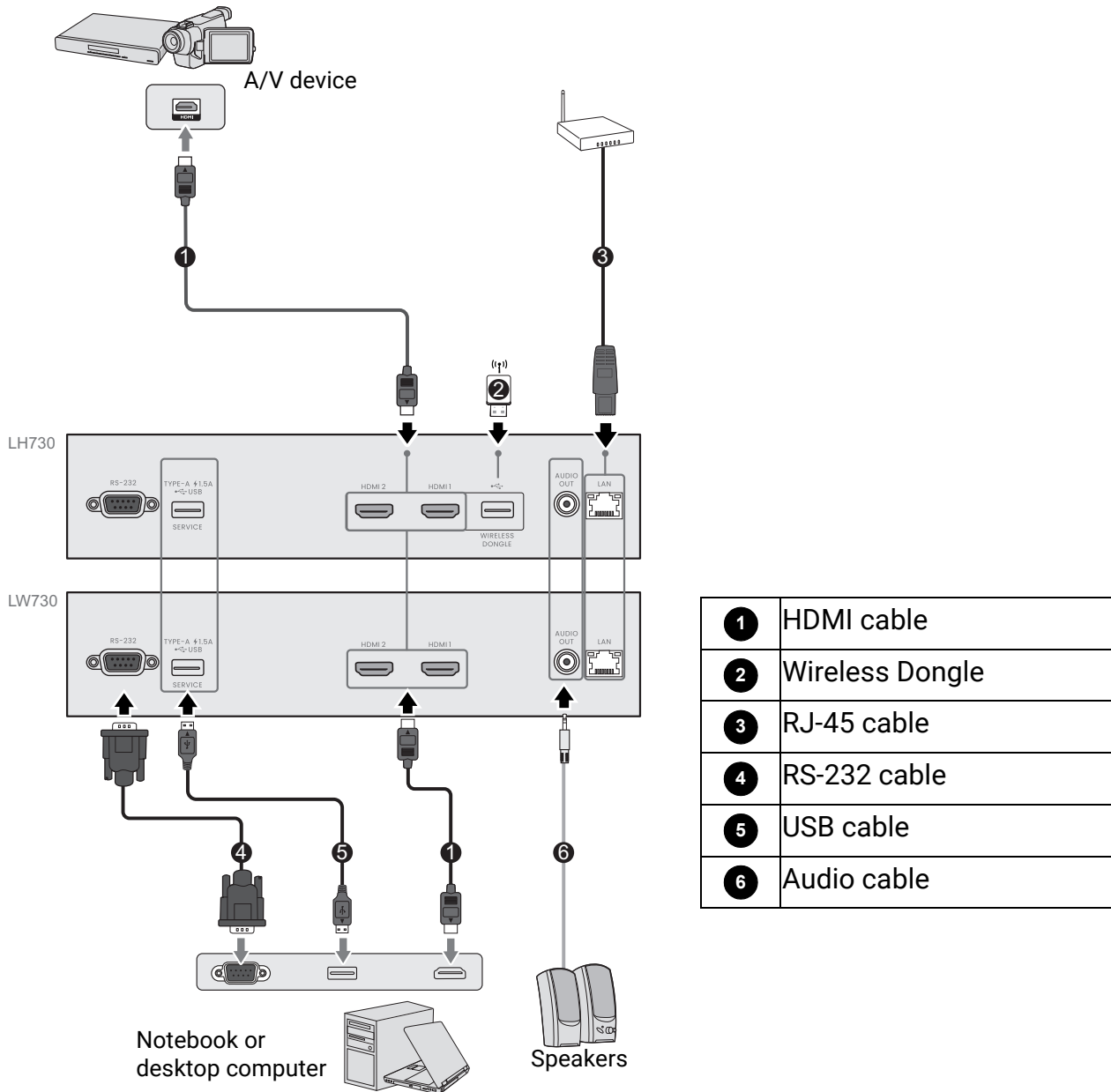

- In the connections above, some cables may not be included with the projector (see [Shipping contents on page 7](#)). They are commercially available from electronics stores.
- The connection illustrations are for reference only. The rear connecting jacks available on the projector vary with each projector model.
- Many notebooks do not turn on their external video ports when connected to a projector. Usually a key combo like FN + function key with a monitor symbol turns the external display on/off. Press FN and the labeled function key simultaneously. Refer to your notebook's documentation to find your notebook's key combination.
- If the selected video image is not displayed after the projector is turned on and the correct video source has been selected, check that the video source device is turned on and operating correctly. Also check that the signal cables have been connected correctly.

Connecting audio

The projector has built-in mono speaker(s) which are designed to provide basic audio functionality accompanying data presentations for business purposes only. They are not designed for, nor intended for stereo audio reproduction use as might be expected in home theater or home cinema applications. Any stereo audio input (if provided), is mixed into a common mono audio output through the projector speaker(s).

The built-in speaker(s) will work only when **Internal Speaker** is selected in the **Advanced menu - Audio > Audio Outputs** menu.



- The projector is only capable of playing mixed mono audio, even if a stereo audio input is connected.
- If the selected video image is not displayed after the projector is turned on and the correct video source has been selected, check that the video source device is turned on and operating correctly. Also check that the signal cables have been connected correctly.

Connecting the Wireless Dongle (optional for LH730)

The projector has equipped with a **WIRELESS DONGLE** port for the Wireless Dongle (EZC5201BS) which supports wireless projection between the projector and the following systems: iOS, macOS, Android, Windows.

After inserting the WiFi dongle into the **WIRELESS DONGLE** port, select **Wireless Display** from the source selection bar. You can follow the on-screen instructions to enable wireless projection.

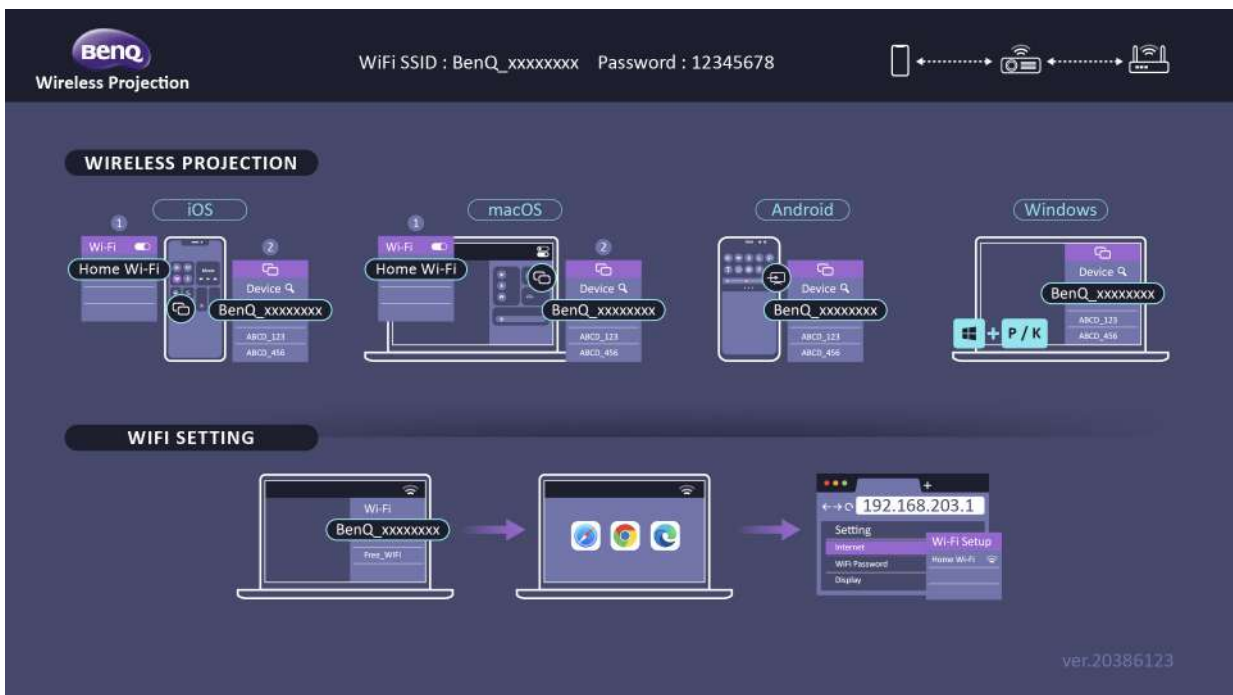

Connecting the projector to the Internet

1. Select the WiFi SSID (BenQ_XXXXXXXX) of the projector in the WiFi settings on your device.
2. Enter the password from the projected image.
3. Open your web browser and go to the address of the projector (192.168.203.1).
4. Select a WiFi network that you want to join.
5. Enter the password if asked.

Performing wireless projection

For different devices, follow the steps below.

- For iOS/macOS devices

1. Select the WiFi network that the projector joined in the WiFi settings on your device.
2. After opening control center, press screen mirroring and choose the projector (BenQ_xxxxxxx) to start projection.

- For Android devices



After opening the Quick settings panel, press the Screen Mirroring icon and choose the projector (BenQ_xxxxxxx).

- For Windows OS devices

Press the Windows + P / K and choose the projector (BenQ_xxxxxxx).

Operation

Starting up the projector

1. Plug the power cord. Turn on the power outlet switch (where fitted). The power indicator on the projector lights orange after power has been applied.
2. Press  on the projector or  on the remote control to start the projector. The power indicator flashes green and stays green when the projector is on.

The start up procedure takes about 10 seconds. In the later stage of start up, a startup logo is projected.

(If necessary) Rotate the focus ring to adjust the image clearness.

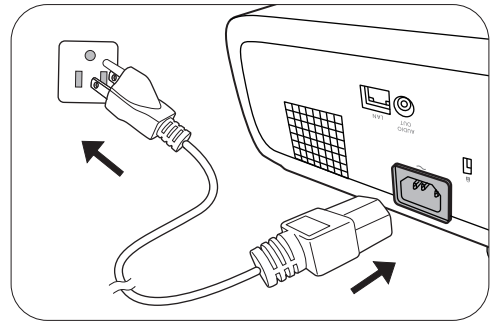

3. If the projector is activated for the first time, select your OSD language following the on-screen instructions.
4. If you are prompted for a password, press the arrow keys to enter a 6-digit password. See [Utilizing the password function on page 24](#).
5. Switch all of the connected equipment on.



6. The projector will search for input signals. The current input signal being scanned appears. If the projector does not detect a valid signal, the message "No Signal" will continue displaying until an input signal is found.

You can also press **SOURCE** to select your desired input signal. See [Switching input signal on page 25](#).



- Please use the original accessories (e.g. power cord) to avoid possible dangers such as electric shock and fire.
- If the projector is still hot from previous activity, it will run the cooling fan for approximately 90 seconds before energizing the light source.



- The Setup Wizard screenshots are for reference only and may differ from the actual design.
- If the frequency/resolution of the input signal exceeds the projector's operating range, you will see the message "Out of Range" displayed on the background screen. Please change to an input signal which is compatible with the projector's resolution or set the input signal to a lower setting. See [Timing chart on page 53](#).
- If no signal is detected for 3 minutes, the projector automatically enters saving mode.

Using the menus

The projector is equipped with 2 types of On-Screen Display (OSD) menus for making various adjustments and settings.

- **Basic** OSD menu: provides primary menu functions. (See [Basic Menu on page 28](#))
- **Advanced** OSD menu: provides full menu functions. (See [Advanced Menu on page 29](#))

To access the OSD menu, press **MENU** on the projector or remote control.

- Use the arrow keys (▲/▼/◀/▶) on the projector or remote control to move through the menu items.
- Use **OK** on the projector or remote control to confirm the selected menu item.

The first time you use the projector (after finishing the initial setup), press **MENU**, and the **Advanced** OSD menu will be displayed.



The OSD screenshots below are for reference only, and may differ from the actual design.

Below is the overview of the **Basic** OSD menu.

The screenshot shows the Basic OSD menu with the following items: Picture Mode (Presentation), Volume (10), Aspect Ratio (Auto), Brightness (50), Light Source Mode (SmartEco), Information, 2D Keystone, and Menu Type. At the bottom, there are buttons for HDMI, OK Exit, and MENU Exit. Numbered callouts point to: 1. Menu type (Basic menu), 2. Sub-menu and status (Picture Mode, Aspect Ratio, Light Source Mode, 2D Keystone), 3. Current input signal (HDMI), and 4. Function keys (OK Exit, MENU Exit).

If you intend to switch from the **Basic** OSD menu to the **Advanced** OSD menu, follow the instructions below:

1. Go to **Menu Type** and press **OK**.
2. Press **▲ / ▼** to select **Advanced** and press **OK**. Your projector will switch to **Advanced** OSD menu.

Below is the overview of the **Advanced** OSD menu.

The screenshot shows the Advanced OSD menu with a main menu on the left (Picture, Audio, Display, Installation, System, Information) and a sub-menu on the right (Picture Mode - Presentation). The sub-menu includes User Management, Brightness (50), Contrast (0), Sharpness (0), Advanced Color Settings, and a Reset Current Picture Mode button. At the bottom, there are buttons for HDMI, OK Enter, BACK Return, and MENU Exit. Numbered callouts point to: 1. Main menu (Picture, Audio, Display, Installation, System, Information), 2. Current input signal (HDMI), 3. Sub-menu and status (Picture Mode - Presentation), and 4. Function keys (OK Enter, BACK Return, MENU Exit).

Likewise, when you wish to switch from the **Advanced** OSD menu to the **Basic** OSD menu, follow the instructions below:

1. Go to **System > Menu Settings > Menu Type** and press **OK**.
2. Press **▲ / ▼** to select **Basic**. Your projector will switch to the **Basic** OSD menu.

Securing the projector

Utilizing the password function

Setting a password

1. Go to **Advanced** menu - **System > Security Settings > Password**. Press **OK**. The **Password** page appears.
2. Highlight **Change Password** and press **OK**.
3. The four arrow keys (**▲**, **▶**, **▼**, **◀**) respectively represent 4 digits (1, 2, 3, 4). According to the password you desire to set, press the arrow keys to enter six digits for the password.
4. Confirm the new password by re-entering the new password.
5. To activate the **Power On Lock** function, go to **System > Security Settings > Password > Power On Lock**, press **OK** and **◀/▶** to select **On**. Input the password again.



- The digits being input will display as asterisks on-screen. Make a note of your selected password and keep it in a safe place in advance or right after the password is entered so that it is available to you should you ever forget it.
- Once a password has been set and the **Power On Lock** is activated, the projector cannot be used unless the correct password is entered every time the projector is started.

If you forget the password

If you enter the wrong password, the password error message will appear, and the **Input Password** message follows. If you absolutely do not remember the password, you can use the password recall procedure. See [Entering the password recall procedure on page 24](#).

If you enter an incorrect password 5 times in succession, the projector will automatically shut down in a short time.

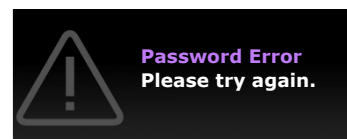

Entering the password recall procedure

1. Press and hold **OK** for 3 seconds. The projector will display a coded number on the screen.
2. Write down the number and turn off your projector.
3. Seek help from the local BenQ service center to decode the number. You may be required to provide proof of purchase documentation to verify that you are an authorized user of the projector.

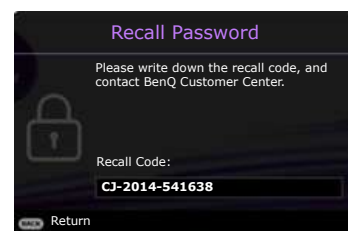

Changing the password

1. Go to **Advanced** menu - **System** > **Security Settings** > **Password**. Press **OK**. The **Password** page appears.
2. Highlight **Change Password** and press **OK**.
3. Enter the old password.
 - If the password is correct, another message **Input New Password** appears.
 - If the password is incorrect, the password error message will appear, and the message **Input Current Password** appears for your retry. You can press **BACK** to cancel the change or try another password.
4. Enter a new password.
5. Confirm the new password by re-entering the new password.

Disabling the password function

To disable password protection, go to **Advanced** menu - **System** > **Security Settings** > **Password** > **Power On Lock** and press **OK** and **◀/▶** to select **Off**. The message **Input Password** appears. Enter the current password.

- If the password is correct, the OSD menu will disappear. You will not have to enter the password next time turning on the projector.
- If the password is incorrect, the password error message will appear, and the message **Input Current Password** appears for your retry. You can press **BACK** to cancel the change or try another password.



Though the password function is disabled, you need to keep the old password in hand should you ever need to re-activate the password function by entering the old password.

Switching input signal

The projector can be connected to multiple devices at the same time. However, it can only display one full screen at a time. When starting up, the projector automatically searches for the available signals.

Be sure the **Advanced** menu - **Display** > **Auto Source Search** menu is **On** if you want the projector to automatically search for the signals.

To manually select the source:

1. Press **SOURCE**. A source selection bar appears.
2. Press **▲/▼** until your desired signal is selected and press **OK**.

Once detected, the selected source information will appear at the corner of the screen for seconds. If there is multiple equipment connected to the projector, repeat steps 1-2 to search for another signal.



- The brightness level of the projected image will change accordingly when you switch between different input signals.
- For best display picture results, you should select and use an input signal which outputs at the projector's native resolution. Any other resolutions will be scaled by the projector depending upon the "aspect ratio" setting, which may cause some image distortion or loss of picture clarity. See [Aspect Ratio on page 36](#).



Connecting the projector to the Internet

If you are in a DHCP environment:

1. Take a RJ45 cable and connect one end to the RJ45 LAN input jack of the projector and the other end to the RJ45 port.



When connecting the RJ45 cable, avoid coiling and intertwining the cable as it may cause signal noise or interruption.

2. Make sure the menu type is **Advanced**. See [Using the menus on page 23](#) for how to switch to the **Advanced** OSD menu.
3. Go to the **Advanced** menu - **System** > **Network Settings** menu.
4. Highlight **Wired LAN** and then press **OK**. The **Wired LAN** page is displayed.
5. Press **▲/▼** to highlight **DHCP** and press **◀/▶** to select **On**.
6. Press **▲/▼** to highlight **Apply** and press **OK**.
7. Go back to the **Network** page.
8. Press **▲/▼** to highlight **AMX Device Discovery** and press **◀/▶** to select **On** or **Off**. When **AMX Device Discovery** is **On**, the projector can be detected by AMX controller.
9. Please wait for around 15 - 20 seconds, and then re-enter the **Wired LAN** page.
10. The **IP Address**, **Subnet Mask**, **Default Gateway**, and **DNS Server** settings will be displayed. Note down the IP address displayed in the **IP Address** row.





If the **IP Address** still does not display, contact your ITS administrator.

If you are in a non-DHCP environment:

1. Repeat steps 1-4 above.
2. Press **▲/▼** to highlight **DHCP** and press **◀/▶** to select **Off**.
3. Contact your ITS administrator for information on the **IP Address**, **Subnet Mask**, **Default Gateway**, and **DNS Server** settings.
4. Press **▲/▼** to select the item you want to modify and press **OK**.
5. Press **◀/▶** to move the cursor and then press **▲/▼** to enter the value.
6. To save the setting, press **OK**. If you do not want to save the setting, press **BACK**.
7. Press **▲/▼** to highlight **Apply** and press **OK**.
8. Press **BACK** to return to **Wired LAN** page, press **▲/▼** to highlight **AMX Device Discovery** and press **◀/▶** to select **On** or **Off**.
9. Press **BACK** to exit the menu.

Shutting down the projector

1. Press  and a confirmation message will appear prompting you. If you don't respond in a few seconds, the message will disappear.
2. Press  a second time. The power indicator flashes orange, the projection light source shuts down, and the fans will continue to run for approximately 2 seconds to cool down the projector.
3. Once the cooling process finishes, the power indicator becomes a steady orange and fans stop. Disconnect the power cord from the power outlet.

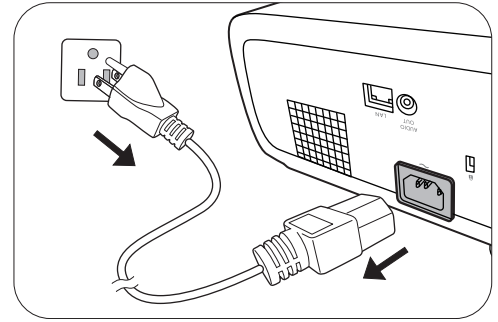

To protect the light source, the projector will not respond to any commands during the cooling process.

Menu operation

Please note that the on-screen display (OSD) menus vary according to the signal type selected and the projector model you are using.

The menu items are available when the projector detects at least one valid signal. If there is no equipment connected to the projector or no signal detected, limited menu items are accessible.

Basic Menu

Menu (Ref. Page)	Options
Picture Mode (30)	LW730: Bright/Presentation/Spreadsheet/Video Conference/Infographic/(3D)/User1/User2 LH730: Bright/Presentation/Spreadsheet/Video Conference/Infographic/(3D)/(HDR10)/(HLG)/User1/User2
Aspect Ratio (36)	Auto/4:3/16:9/16:10
Light Source Mode (48)	Normal ECO SmartEco Custom
2D Keystone (17)	H: -30~0~30 V: -30~0~30
Volume (35)	0 – 20
Brightness (31)	0–100
Information (46)	Native Resolution Detected Resolution Source Picture Mode Light Source Mode 3D Format Color System Dynamic Range (LH730 only) Light Source Usage Time Firmware Version Service Code
Menu Type (44)	Basic/Advanced

Advanced Menu

1. Main menu: **Picture**

Structure

Menu	Options		
Picture Mode	LW730: Bright/Presentation/ Spreadsheet/Video Conference/ Infographic/(3D)/User1/User2 LH730: Bright/Presentation/ Spreadsheet/Video Conference/ Infographic/(3D)/(HDR10)/(HLG)/ User1/User2		
User Management	Load Settings From Rename User Mode		
Brightness	0–100		
Contrast	0–100		
Sharpness	0–31		
Advanced Color Settings	Gamma Selection	1.8/2.0/2.1/2.2/2.3/2.4/2.5/2.6/BenQ	
	Color Temperature Tuning	Color Temperature	Normal/Cool/Native/Warm
		R Gain/G Gain/B Gain	0–200
		R Offset/ G Offset/ B Offset	0–511
	Color Management	R/G/B/C/M/Y	Hue/Saturation/Gain
		W (White Balance)	R Gain/G Gain/B Gain
		Reset	Reset/Cancel
	Light Source Mode	Normal/ECO/SmartEco/Custom	
	Custom Brightness	70%–100%	
	HDR Brightness (LH730 only)	-2/-1/0/1/2	
Noise Reduction	0 – 31		
Reset Current Picture Mode	Reset/Cancel		

Function descriptions

Menu	Descriptions
Picture Mode	<p>The projector is preset with several predefined picture modes so that you can choose one to suit your operating environment and input signal picture type.</p> <ul style="list-style-type: none">• Bright: Maximizes the brightness of the projected image. This mode is suitable for environments where extra-high brightness is required.• Presentation: Is designed for presentations. The brightness is emphasized in this mode to match PC and notebook coloring.• Spreadsheet: Designs for users who widely use excel and table to discuss financial numbers or quality numbers in meetings.• Video Conference: Design for video conference scenarios which showcases detail skin color of remote meeting attendees.• Infographic: Is perfect for presentations with the mixture of text and graphics due to its high color brightness and better color gradation to see the details clearly.• 3D: Is appropriate for playing 3D images and 3D video clips. This mode is only available when 3D function is enabled and 3D content is detected.• HDR10 (only for LH730): Delivers High Dynamic Range effects with higher contrasts of brightness and colors for HDR Blu-ray movies. Picture Mode will be switched to HDR10 automatically while detecting metadata or EOTF info from HDR contents.• HLG (only for LH730): Delivers High Dynamic Range effects with higher contrasts of brightness and colors. Picture Mode will be switched to HLG automatically while detecting metadata or EOTF info from HLG streaming contents.• User1/User2: Recalls the settings customized based on the current available picture modes. See User Management on page 31.

There is one user-definable mode if the current available picture modes are not suitable for your need. You can use one of the picture modes (except the **User1/User2** mode) as a starting point and customize the settings.

• **Load Settings From**

1. Go to **Picture > Picture Mode**.
2. Press **◀/▶** to select **User1** or **User2**.
3. Press **▼** to highlight **User Management**, and press **OK**. The **User Management** page is displayed.
4. Select **Load Settings From** and press **OK**.
5. Press **▼/▲** to select a picture mode that is closest to your need.
6. Press **OK** and **BACK** to return to the **Picture** menu.
7. Press **▼** to select the sub-menu items you want to change and adjust the values with **◀/▶**. The adjustments define the selected user mode.

• **Rename User Mode**

Select to rename the customized picture mode (**User1/User2**). The new name can be up to 9 characters including English letters (A-Z, a-z), digits (0-9), and space (_).

1. Go to **Picture > Picture Mode**.
2. Press **◀/▶** to select **User1** or **User2**.
3. Press **▼** to highlight **User Management**, and press **OK**. The **User Management** page is displayed.
4. Press **▼** to highlight **Rename User Mode** and press **OK**. The **Rename User Mode** page is displayed.
5. Use **▲/▶ /▼/◀**, and **OK** to set desired characters.
6. When done, press **BACK** to save the changes and exit.

User Management

Brightness

The higher the value, the brighter the image. Adjust this control so the black areas of the image appear just as black and that detail in the dark areas is visible.

Contrast

The higher the value, the greater the contrast. Use this to set the peak white level after you have previously adjusted the Brightness setting to suit your selected input and viewing environment.

Sharpness

The higher the value, the sharper the picture becomes.

• Gamma Selection

Gamma refers to the relationship between input source and picture brightness.

- **1.8/2.0/2.1/BenQ**: Select these values according to your preference.
- **2.2/2.3**: Increases the average brightness of the picture. Best for a lit environment, meeting room or family room.
- **2.4/2.5**: Best for viewing movies in a dark environment.
- **2.6**: Best for viewing movies which are mostly composed of dark scenes.

High Brightness
Low Contrast

Low Brightness
High Contrast

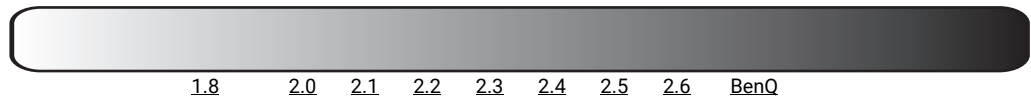

Advanced Color Settings

• Color Temperature Tuning

There are several preset color temperature settings available. The available settings may vary according to the signal type selected.

- **Normal**: Maintains normal colorings for white.
- **Cool**: Makes images appear bluish white.
- **Native**: With the light source's original color temperature and higher brightness. This setting is suitable for environments where high brightness is required, such as projecting pictures in well lit rooms.
- **Warm**: Makes images appear reddish white.

You can also set a preferred color temperature by adjusting the following options.

- **R Gain/G Gain/B Gain**: Adjusts the contrast levels of Red, Green, and Blue.
 - **R Offset/G Offset/B Offset**: Adjusts the brightness levels of Red, Green, and Blue.
-

• Color Management

The Color Management provides six sets (RGBCMY) of colors to be adjusted. When you select each color, you can independently adjust its range and saturation according to your preference.

To make adjustments, press the ▲/▼ arrows to highlight an independent color from among Red (R), Green (G), Blue (B), Cyan (C), Magenta (M), Yellow (Y) or White (W). The following menu items are displayed for your choice.

- **Hue:** Increase in the range will include colors consisted of more proportions of its two adjacent colors. Please refer to the illustration for how the colors relate to each other.
For example, if you select Red and set its range at 0, only pure red in the projected picture will be selected. Increasing its range will include red close to yellow and red close to magenta.

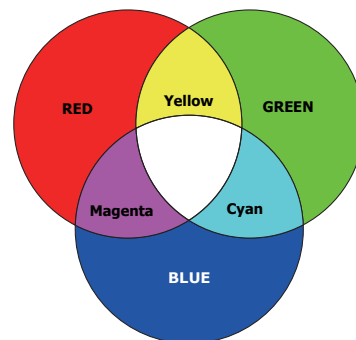

- **Saturation:** Adjusts the values to your preference. Every adjustment made will reflect to the image immediately. For example, if you select Red and set its value at 0, only the saturation of pure red will be affected.
- **Gain:** Adjusts the values to your preference. The contrast level of the primary color you select will be affected. Every adjustment made will reflect to the image immediately.

If you select **White Balance**, you can adjust the contrast levels of Red, Green, Blue, Cyan, Magenta, Yellow and White by selecting **R Gain**, **G Gain**, and **B Gain**.

To return all the settings to the factory default values, highlight **Reset**, and press **OK**.



Saturation is the amount of that color in a video picture. Lower settings produce less saturated colors; a setting of "0" removes that color from the image entirely. If the saturation is too high, that color will be overpowering and unrealistic.

• Light Source Mode

Selects a suitable light source power from among the provided modes. See [Extending light source life on page 48](#).

• Custom Brightness

You can adjust the light source brightness. This function is only available when **Light Source Mode** is **Custom**.

Advanced Color Settings (Continued)

**Advanced Color
Settings
(Continued)**

• **HDR Brightness**

The projector can automatically adjust the brightness levels of your image according to the input source. You can also manually select a brightness level to display better picture quality. When the value is higher, the image becomes brighter; when the value is lower, the image becomes darker.

• **Noise Reduction**

Reduces electrical image noise caused by different media players.

**Reset Current
Picture Mode**

Returns all of the adjustments you've made for the selected **Picture Mode** (including the preset mode, **User1** and **User2**) to the factory preset values.

1. Press **OK**. The confirmation message is displayed.
2. Use ◀/▶ to select **Reset** and press **OK**. The current picture mode returns to the factory preset settings.



The following settings will still remain: **Load Settings From**.

2. Main menu: **Audio**

Structure

Menu	Options
Audio Outputs	Internal Speaker/3.5mm Jack
Mute	Off/On
Volume	0 – 20
Power On/Off Ring Tone	Off/On
Reset Audio	Reset/Cancel

Function descriptions



Menu	Descriptions
Audio Outputs	Selects an audio output source from built-in speakers (Internal Speaker), or the audio output jack (3.5mm Jack).
Mute	Select On to temporarily turn off the projector's internal speaker or the volume being output from the audio output jack. To restore the audio, select Off .
Volume	Adjusts the volume level of the projector's internal speaker or the volume being output from the audio output jack. If the Mute function is activated, adjusting Volume will turn off the Mute function.
Power On/Off Ring Tone	Sets the ring tone for the projector On or Off . The Power On/Off Ring Tone can only be adjusted here. Setting the sound mute or adjusting the sound level do not affect the Power On/Off Ring Tone .
Reset Audio	Returns all of the adjustments you've done under the Audio menu to the factory preset values.

3. Main menu: **Display**

Structure

Menu		Options
Aspect Ratio		Auto/4:3/16:9/16:10
Auto Source Search		Off/On
Source Rename		HDMI-1/HDMI-2
3D	3D Mode	Auto/Top Bottom/Frame Sequential/Frame Packing/Side by Side/Off
	3D Sync Invert	Disable/Invert
	Save 3D Settings	3D Settings 1/3D Settings 2/3D Settings 3
	Apply 3D Settings	3D Settings 1/3D Settings 2/3D Settings 3/Off
HDMI Settings	HDMI Format	Auto/Limited/Full
	HDMI Equalizer	HDMI-1/HDMI-2 Auto/1/2/3/4/5
	HDMI EDID (LH730 only)	HDMI-1/HDMI-2 Enhanced/Standard
Reset Display		Reset/Cancel

Function descriptions

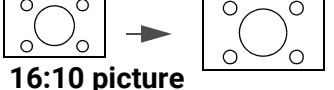
Menu	Descriptions
Aspect Ratio	<p>There are several options to set the image's aspect ratio depending on your input signal source.</p> <ul style="list-style-type: none"> • Auto: Scales an image proportionally to fit the projector's native resolution in its horizontal or vertical width. • 4:3: Scales an image so that it is displayed in the center of the screen with a 4:3 aspect ratio. • 16:9: Scales an image so that it is displayed in the center of the screen with a 16:9 aspect ratio. • 16:10: Scales an image so that it is displayed in the center of the screen with a 16:10 aspect ratio.
	 <p>15:9 picture</p>
	 <p>4:3 picture</p>
	 <p>16:9 picture</p>
	 <p>16:10 picture</p>
Auto Source Search	Allows the projector to automatically search for a signal.

Renames the current input source to your desired name.

On the **Source Rename** page:

Source Rename

1. Press **OK** to display the on-screen keyboard.
2. Press **▲/▼/◀/▶** to select each desired digit/letter, and press **OK** to confirm each input.
3. Repeat the step above and when done, press **BACK** and **▼** to highlight **Commit**.
4. Press **OK** and the source name changes.

3D

This projector supports playing three-dimensional (3D) content transferred through your 3D-compatible video devices and contents, such as PlayStation consoles (with 3D game discs), 3D Blu-ray players (with 3D Blu-ray discs), and so on. After you have connected the 3D video devices to the projector, wear a pair of 3D glasses and make sure the power is on to view 3D contents.

When watching 3D contents:

- The image may seem misplaced; however, this is not a product malfunction.
- Take appropriate breaks when watching 3D contents.
- Stop watching 3D contents if you feel fatigue or discomfort.
- Keep a distance from the screen of about three times the effective height of the screen.
- Children and people with a history of oversensitivity to light, heart problems, or any other existing medical conditions should be refrained from watching 3D contents.
- The image may seem reddish, greenish, or bluish without wearing 3D glasses. However, you will not notice any color bias when watching 3D contents with 3D glasses.
- The 4K source will not be displayed.

- **3D Mode**

The projector can automatically enable 3D mode via the contents when the source type is HDMI and supports 1.4a. If you want the projector to automatically choose an appropriate 3D format when detecting 3D contents, select **Auto**. If the projector cannot recognize the 3D format, choose a 3D mode from among **Top Bottom**, **Frame Sequential**, **Frame Packing** and **Side by Side**.

When **3D Mode** is enabled:

- The brightness level of the projected image decreases.
- The **Picture Mode** cannot be adjusted.
- The **2D Keystone** can only be adjusted within limited degrees.

- **3D Sync Invert**

When your 3D image is distorted, enable this function to switch between the image for the left eye and the right eye for more comfortable 3D viewing experience.

- **Save 3D Settings**

When you have successfully displayed the 3D contents after making the appropriate adjustments, you can enable this function and choose a set of 3D settings to memorize current 3D settings.

- **Apply 3D Settings**

After the 3D settings are saved, you can decide if you would like to apply them by choosing a set of 3D settings that you have saved. Once applied, the projector will automatically play the incoming 3D contents if it matches the 3D settings saved.



Only the set(s) of 3D settings with memorized data is available.

- **HDMI Format**

Selects a suitable RGB color range to correct the color accuracy.

- **Auto:** Automatically selects a suitable color range for the incoming HDMI signal.
- **Limited:** Utilizes the Limited range RGB 16-235.
- **Full:** Utilizes the Full range RGB 0-255.

HDMI Settings

- **HDMI Equalizer**

Sets a suitable value to maintain the HDMI picture quality in long distance data transmission.

- **HDMI EDID**

Switches between **Enhanced** for HDMI 2.0 EDID and **Standard** for HDMI 1.4 EDID. Selecting **Standard** which supports up to 1080p 60Hz may solve abnormal display issues with some old players.

Reset Display

Returns all the settings on the **Display** main menu to the factory default values.

4. Main menu: **Installation**

Structure

Menu		Options
Projector Position		Front/Front Ceiling/Rear/Rear Ceiling
2D Keystone		H: -30 – +30 V: -30 – +30
Auto Vertical Keystone		Off/On
Test Pattern		On/Off
High Altitude Mode		On/Off
Baud Rate		9600/14400/19200/38400/57600/ 115200
Corner Fit		0~60
Digital Zoom		1.0X – 1.8X/2.0X
Digital Shrink & Shift		0.75X~1.0X
Image Resizing		Modes of Adjustment Top Bottom Left Right Reset All Blanking Settings
Blanking		
Image Memory		Save Image Memory Apply Image Memory Rename Memory-1/Memory-2/Memory-3/ Memory-4/Memory-5

Function descriptions

Menu	Descriptions
Projector Position	The projector can be installed on a ceiling or behind a screen, or with one or more mirrors. See Choosing a location on page 11 for details.
2D Keystone	See Correcting keystone on page 17 for details.
Auto Vertical Keystone	Automatically corrects the keystone at the top/bottom side of the projected image.

Test Pattern Adjusts the image size and focus and check that the projected image is free from distortion.

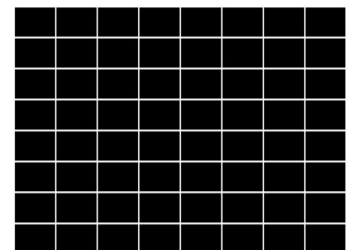

<p>High Altitude Mode</p>	<p>We recommend you use the High Altitude Mode when your environment is between 1500 m–3000 m above sea level, and ambient temperature is between 0°C–30°C.</p> <p>Operation under "High Altitude Mode" may cause a higher decibel operating noise level because of increased fan speed necessary to improve overall system cooling and performance.</p> <p>If you use this projector under other extreme conditions excluding the above, it may display auto shut-down symptoms, which is designed to protect your projector from over-heating. In cases like this, you should switch to High Altitude mode to solve these symptoms. However, this is not to state that this projector can operate under any and all harsh or extreme conditions.</p> <div data-bbox="391 638 470 705" style="text-align: center;">  </div> <p>Do not use the High Altitude Mode if your altitude is between 0 m and 1500 m and ambient temperature is between 0°C and 35°C. The projector will be over cooled, if you turn the mode on under such a condition.</p>
<p>Baud Rate</p>	<p>Selects a baud rate that is identical with your computer's so that you can connect the projector using a suitable RS-232 cable. This function is intended for qualified service personnel.</p>
<p>Corner Fit</p>	<p>See Adjusting Corner Fit on page 18 for details.</p>

- **Digital Zoom**

Magnifies or reduces the projected image size.

1. After the adjustment bar displays, press ▲/▼ on the projector or **ZOOM+/ZOOM-** on the remote control repeatedly to reduce or magnify the image to a desired size.
2. Press **OK** to enter panning mode.
3. Press the directional arrows (▲, ▼, ◀, ▶) on the projector or remote control to navigate the picture.



The picture can only be navigated after it is magnified. You can further magnify the picture while searching for details.

- **Digital Shrink & Shift**

Shrinks and/or shifts the projected image.

1. After the adjustment bar displays, press ◀/▶ repeatedly to shrink or magnify the picture to a desired size.
2. Press **OK** to activate digital shift function.
3. After digital shift function is activated, press the directional arrows (▲, ▼, ◀, ▶) to shift the image.

Image Resizing



The picture can only be shifted after it shrank.

- **Blanking**

Blanks some parts of the projected image.

1. Select the **Modes of Adjustment** first by pressing ◀/▶.
2. Press ▲/▼ to highlight the area you want to adjust and press ◀/▶ to adjust its range.



Enacting the **Reset All Blanking Settings** function will return all items in the **Blanking** menu to the factory preset values. Pressing **OK** clears the values of selected item (excluding **Modes of Adjustment**).

Image Memory

- **Save Image Memory:** Allows you to save and apply several sets of image settings for regularly used circumstances, including the following settings: **Projector Position, Aspect Ratio, Picture Mode, Source, Resolution, Light Source Mode, Digital Shrink & Shift, Blanking**. You can choose one set of memory to save the current settings.
 - **Apply Image Memory:** After the image memories are saved, you can decide if you would like to apply it by choosing a set of memory that you have saved.
 - **Rename:** Renames the image memories.
-







5. Main menu: **System**

Structure

Menu		Options		
Language		English/Français/Deutsch/Italiano/Español/ Русский/繁體中文/简体中文/日本語/한국어/ Svenska / Nederlands/Türkçe/Čeština/ Português/ไทย/Polski/Magyar/Hrvatski/ Română/Norsk/Dansk/Български/ Suomi/Bhs Ind / Ελληνικά/ العربية/ हिंदी / فارسی / Tiếng Việt		
Background Settings	Background Color	Black/Blue/Purple		
	Splash Screen	BenQ/Black/Blue		
Menu Settings	Menu Type	Basic/Advanced		
	Menu Display Time	5 sec/10 sec/20 sec/30 sec/Always		
	Menu Position	Center/Top-Left/Top-Right/ Bottom-Right/Bottom-Left		
	Reminder Message	Off/On		
Light Source Information	Light Source Usage Time			
	Normal Mode			
	ECO Mode			
	SmartEco Mode			
	Custom Mode			
Standby Settings	Equivalent Light Hours			
	Standby Mode	Eco/Network/Normal		
	Auto Disable Network Standby Mode	Never/20 min/1 hr/3 hr/6 hr		
	Audio Pass Through	Never/HDMI-1/HDMI-2		
Operation Settings	LED Indicator	Off/On		
	Power On/Off Settings	Direct Power On	Off/On	
		Signal Power On	HDMI-1/HDMI-2	
		Auto Power Off	Disable/3 min/10 min/15 min/ 20 min/25 min/30 min	
Security Settings	Panel Key Lock	Off/On	Yes/No	
	Password	Change Password Power On Lock		
Network Settings		Status		
		DHCP	Off/On	
	Wired LAN	IP Address		
		Subnet Mask		
		Default Gateway		
		DNS Server		
		Apply		
	AMX Device Discovery	Off/On		
	MAC Address (Wired)			
Factory Default	Reset/Cancel			
Reset System	Reset/Cancel			

Function descriptions

Menu	Descriptions
Language	Sets the language for the On-Screen Display (OSD) menus.
Background Settings	<ul style="list-style-type: none"> • Background Color <p>Sets the background color for the projector.</p> <ul style="list-style-type: none"> • Splash Screen <p>Allows you to select which logo screen will be displayed during projector start-up.</p>
Menu Settings	<ul style="list-style-type: none"> • Menu Type <p>Sets the OSD menu type according to your needs.</p> <ul style="list-style-type: none"> • Menu Display Time <p>Sets the length of time the OSD will remain active after your last key press.</p> <ul style="list-style-type: none"> • Menu Position <p>Sets the On-Screen Display (OSD) menu position.</p> <ul style="list-style-type: none"> • Reminder Message <p>Sets the reminder messages on or off.</p>
Light Source Information	<p>This menu page displays the following information:</p> <ul style="list-style-type: none"> • Light Source Usage Time <p>Light hours used under Normal Mode, ECO Mode, SmartEco, Custom Mode.</p>
Standby Settings	<ul style="list-style-type: none"> • Standby Mode <ul style="list-style-type: none"> • Eco: The projector maintains at normal standby mode with less than 0.5W power consumption. • Network: The projector maintains at network standby mode with less than 2W power consumption. • Normal: Allows the projector to provide network, monitor out and audio pass through functions in standby mode. • Auto Disable Network Standby Mode <p>Allows the projector to disable the network function after a set period of time after it enters standby mode. For instance, if 20 min is selected, the projector is able to provide the network function for 20 minutes after it enters standby mode. When 20 minutes is up, the projector enters normal standby mode.</p> <ul style="list-style-type: none"> • Audio Pass Through <p>The projector can play sound when it is in standby mode and the corresponding jacks are correctly connected to devices. Press ◀/▶ to choose the source that you wish to use. See Connection on page 19 for how to make the connection.</p>

Operation Settings	<ul style="list-style-type: none"> • LED Indicator You can turn off the LED warning lights. This is to avoid any light disturbance when viewing images in a dark room. • Power On/Off Settings <ul style="list-style-type: none"> • Direct Power On: Allows the projector to turn on automatically once the power is fed through the power cord. • Signal Power On: Sets whether to turn the projector directly on without pressing  POWER or  ON when the projector is in standby mode and detects a HDMI or DisplayPort signal. • Auto Power Off: Allows the projector to turn off automatically if no input signal is detected after a set period of time to prevent unnecessary waste of light source life.
Security Settings	<ul style="list-style-type: none"> • Panel Key Lock With the control keys on the projector and remote control locked, you can prevent your projector settings from being changed accidentally (by children, for example). When the Panel Key Lock is on, no control keys on the projector and remote control will operate except  POWER. To release panel key lock, press and hold  (the right key) on the projector or remote control for 3 seconds.  <p>If you turn off the projector without disabling panel key lock, the projector will still be in locked status the next time it is turned on.</p> <ul style="list-style-type: none"> • Password/Power On Lock See Utilizing the password function on page 24.
Network Settings	<ul style="list-style-type: none"> • Wired LAN See Connecting the projector to the Internet on page 26. • AMX Device Discovery When this function is On, the projector can be detected by AMX controller. • MAC Address (Wired) Displays the mac address for this projector.
Factory Default	<p>Returns all settings to the factory preset values.</p>  <p>The following settings will still remain: Projector Position, 2D Keystone, Auto Vertical Keystone, High Altitude Mode, Baud Rate, Corner Fit, Digital Lens Shift, Blanking, Light Source Information, Security Settings, Network Settings, Image Memory.</p>
Reset System	<p>Returns all the settings on the System main menu to the factory default values.</p>  <p>The following settings will still remain: Light Source Information, Security Settings, Network Settings.</p>

6. Main menu: **Information**

Structure

Menu	Options
Native Resolution	
Detected Resolution	
Source	
Picture Mode	
Light Source Mode	
3D Format	
Color System	
Dynamic Range (LH730 only)	
Light Source Usage Time	
Firmware Version	
Service Code	

Function descriptions

Menu	Descriptions
Native Resolution	Shows the native resolution of the projector.
Detected Resolution	Shows the native resolution of the input signal.
Source	Shows the current signal source.
Picture Mode	Shows the selected mode on the Picture menu.
Light Source Mode	Shows the used light source mode.
	Displays the current 3D mode.
3D Format	 3D Format is only available when 3D is enabled.
Color System	Shows the input system format.
Dynamic Range	Shows the dynamic range of the input source.
Light Source Usage Time	Shows the number of hours the light has been used.
Firmware Version	Shows the firmware version of your projector.
Service Code	Shows the projector's serial number.

Maintenance

Care of the projector

Cleaning the lens

Clean the lens whenever you notice dirt or dust on the surface. Please be sure to turn off the projector and let it cool down completely before cleaning the lens.

- Use a canister of compressed air to remove dust.
- If there is dirt or smears, use lens-cleaning paper or moisten a soft cloth with lens cleaner and gently wipe the lens surface.
- Never use any type of abrasive pad, alkaline/acid cleaner, scouring powder, or volatile solvent, such as alcohol, benzene, thinner or insecticide. Using such materials or maintaining prolonged contact with rubber or vinyl materials may result in damage to the projector surface and cabinet material.

Cleaning the projector case

Before you clean the case, turn the projector off using the proper shutdown procedure as described in [Shutting down the projector on page 27](#) and unplug the power cord.

- To remove dirt or dust, wipe the case with a soft, lint-free cloth.
- To remove stubborn dirt or stains, moisten a soft cloth with water and a neutral pH detergent. Then wipe the case.



Never use wax, alcohol, benzene, thinner or other chemical detergents. These can damage the case.

Storing the projector

If you need to store the projector for an extended time, please follow the instructions below:

- Make sure the temperature and humidity of the storage area are within the recommended range for the projector. Please refer to [Specifications on page 51](#) or consult your dealer about the range.
- Retract the adjuster feet.
- Remove the battery from the remote control.
- Pack the projector in its original packing or equivalent.

Transporting the projector

It is recommended that you ship the projector with its original packing or equivalent.

Light source information

Getting to know the light hour

When the projector is in operation, the duration (in hours) of light source usage is automatically calculated by the built-in timer. The method of calculating the equivalent light hour is as follows:

1. Light Usage Time = (x+y+z) hours, if
Time used in **Normal** mode = x hours

Time used in **ECO** mode = y hours
 Time used in **SmartEco** mode = z hours
 Time used in **Custom** mode = a hours

2. Equivalent Light Hour = α hours

$$\alpha = \frac{A'}{X} \times \chi + \frac{A'}{Y} \times y + \frac{A'}{Z} \times z + \frac{A'}{A} \times a, \text{ if}$$

X= light source life spec of **Normal** mode
 Y= light source life spec of **ECO** mode
 Z= light source life spec of **SmartEco** mode
 A= light source life spec of **Custom** mode

A' is the longest light life spec among X, Y, Z, A



For time used in each light mode shown in OSD menu:

- Time used is accumulated and rounded down to an integer in **hours**.
- When time used is less than 1 hour, it shows 0 hours.



When you calculate **Equivalent Light Hours** manually, it will probably have deviation from the value shown in OSD menu since projector system calculates time used for each light mode in "Minutes" then rounds down to an integer in hours shown in OSD.

To obtain the light source hour information:

1. Go to **Advanced Menu - Settings > Light Usage Time** and press **OK**.
2. The **Light Usage Time** information is displayed.

You can also get the light source hour information on the **Information** menu.

Extending light source life

- Setting the **Light Source Mode**

Go to **Advanced Menu - Picture > Advanced Color Settings > Light Source Mode** and select a suitable light source power from among the provided modes.

Setting the projector in **ECO**, **SmartEco** or **Custom** mode extends light source life.

Light mode	Description
Normal	Provides full light source brightness
ECO	Lowers brightness to extend the light source life and decreases the fan noise
SmartEco	Adjusts the light source power automatically depending on the content brightness level while optimizing display quality
Custom	Enables the light source brightness adjustment bar so that you can adjust the setting to your liking









































Some of the above light mode(s) may not be available under certain circumstances.







- Setting **Auto Power Off**

This function allows the projector to turn off automatically if no input signal is detected after a set period of time to prevent unnecessary waste of light source life.

To set **Auto Power Off**, go to **Advanced Menu - System > Operation Settings > Power On/Off Settings > Auto Power Off** and press **◀/▶**.

Indicators

Light			Status & Description
POWER ○	TEMP ○	LIGHT ○	
Power events			
			Stand-by mode
			Powering up
			Normal operation
			Normal power-down cooling
			Download
Burn-in events			
			Burn-in on
			Burn-in off
Light events			
			Light source life exhausted
			Light source error in normal operation
Thermal events			
			Fan 1 error (the actual fan speed is outside the desired speed)
			Fan 2 error (the actual fan speed is outside the desired speed)
			Fan 3 error (the actual fan speed is outside the desired speed)
			Temperature 1 error (over limited temperature)

	○: off	 : Orange On  : Orange Flashing	 : Green On  : Green Flashing	 : Red On  : Red Flashing
---	---------------	--	--	--

Troubleshooting

 The projector does not turn on.

Cause	Remedy
There is no power from the power cord.	Plug the power cord into the AC power jack on the projector, and plug the power cord into the power outlet. If the power outlet has a switch, make sure that it is switched on.
Attempting to turn the projector on again during the cooling process.	Wait until the cooling down process has completed.

 No picture

Cause	Remedy
The video source is not turned on or connected correctly.	Turn the video source on and check that the signal cable is connected correctly.
The projector is not correctly connected to the input signal device.	Check the connection.
The input signal has not been correctly selected.	Select the correct input signal with the SOURCE key.

 Blurred image

Cause	Remedy
The projection lens is not correctly focused.	Adjust the focus of the lens using the focus ring.
The projector and the screen are not aligned properly.	Adjust the projection angle and direction as well as the height of the projector if necessary.
The lens cover is still closed.	Open the lens cover.

 Abnormal image

Cause	Remedy
The image is abnormal.	<ul style="list-style-type: none"> • Ensure the video source cable is connected properly, and that the video source is turned on. • Ensure that the air intake or exhaust is not blocked.

 Remote control does not work.

Cause	Remedy
The batteries are out of power.	Replace both of the batteries with new ones.
There is an obstacle between the remote control and the projector.	Remove the obstacle.
You are too far away from the projector.	Stand within 8 meters (26 feet) of the projector.

 The password is incorrect.

Cause	Remedy
You do not remember the password.	See Entering the password recall procedure on page 24 .

Specifications

Projector specifications



All specifications are subject to change without notice.

Optical

Resolution

LW730: 1280 x 800 WXGA

LH730: 1920 x 1080 1080p

Display system

1-CHIP DMD

Lens

F = 1.6 ~ 1.75, f = 19.16 ~ 23.02 mm

Clear focus range

LW730: 1.77 – 4.41 m@Wide, 2.12 – 5.30 m@Tele

LH730: 1.73 – 4.33 m@Wide, 2.08 – 5.19 m@Tele

Light source

LED

Electrical

Power supply

AC100–240V, 4.3 A, 50–60 Hz (Automatic)

Power consumption

415 W (Max); < 0.5 W (Standby)

Mechanical

Weight

5.3 Kg ± 100 g (11.68 lbs ± 0.22 lbs)

Output terminals

Speaker

10 watt x 1

Audio signal output

PC audio jack x 1

Control

USB

Type-A power supply 5V /1.5 A x 1

Type-A power supply 5V /1 A x 1 for WiFi dongle
(**LH730** only)

RS-232 serial control

9 pin x 1

LAN control

RJ45 x 1

IR receiver x 2

Input terminals

Video signal input

SD/HDTV signal input

Digital - HDMI x 2

Environmental Requirements

Operating temperature

0°C–40°C at sea level

Operating relative humidity

10%–90% (without condensation)

Operating altitude

0–1499 m at 0°C–35°C

1500–3000 m at 0°C–30°C (with
High Altitude Mode on)

Storage temperature

-20°C–60°C at sea level

Storage humidity

10%–90% RH (without condensation)

Storage altitude

30°C@ 0~12,200m above sea level

Transporting

Original packing or equivalent is recommended

Repairing

Please visit below website and choose your country to
find your service contact window.

<http://www.benq.com/welcome>

Dimensions

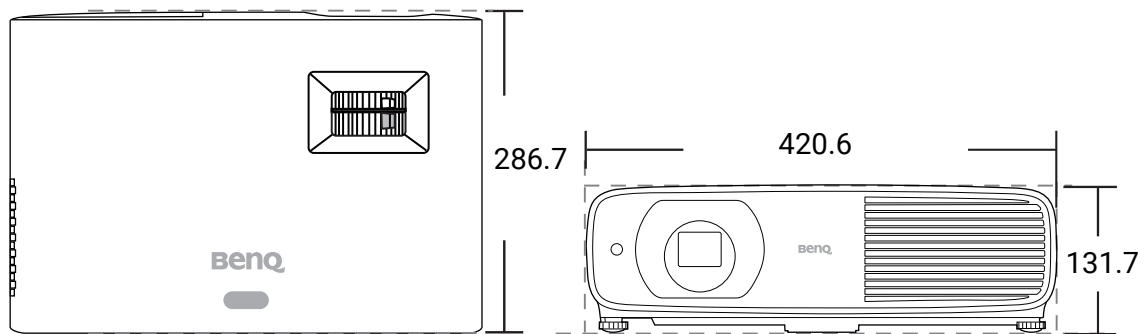

Unit: mm

Timing chart

Supported timing for HDMI (HDCP) input

- PC timings

Resolution	Mode	Vertical Frequency (Hz)	Horizontal Frequency (kHz)	Pixel Frequency (MHz)	Supported 3D format		
					Frame Sequential	Top Bottom	Side by Side
640 x 480	VGA_60	59.940	31.469	25.175	Supported	Supported	Supported
	VGA_72	72.809	37.861	31.500			
	VGA_75	75.000	37.500	31.500			
	VGA_85	85.008	43.269	36.000			
720 x 400	720 x 400_70	70.087	31.469	28.3221			
800 x 600	SVGA_60	60.317	37.879	40.000	Supported	Supported	Supported
	SVGA_72	72.188	48.077	50.000			
	SVGA_75	75.000	46.875	49.500			
	SVGA_85	85.061	53.674	56.250			
1024 x 768	SVGA_120 (Reduce Blanking)	119.854	77.425	83.000	Supported		
	XGA_60	60.004	48.363	65.000	Supported	Supported	Supported
	XGA_70	70.069	56.476	75.000			
	XGA_75	75.029	60.023	78.750			
	XGA_85	84.997	68.667	94.500			
1024 x 600	XGA_120 (Reduce Blanking)	119.989	97.551	115.5	Supported		
	1152 x 864	1152 x 864_75	75	67.5	108		
1024 x 576	BenQ Notebook Timing	60.00	35.820	46.996			
1024 x 600	BenQ Notebook Timing	64.995	41.467	51.419			
1280 x 720	1280 x 720_60	60	45.000	74.250	Supported	Supported	Supported
1280 x 768	1280 x 768_60	59.870	47.776	79.5	Supported	Supported	Supported
1280 x 800	WXGA_60	59.810	49.702	83.500	Supported	Supported	Supported
	WXGA_75	74.934	62.795	106.500			
	WXGA_85	84.880	71.554	122.500			
	WXGA_120 (Reduce Blanking)	119.909	101.563	146.25	Supported		
1280 x 1024	SXGA_60	60.020	63.981	108.000		Supported	Supported
	SXGA_75	75.025	79.976	135.000			
	SXGA_85	85.024	91.146	157.500			
1280 x 960	1280 x 960_60	60.000	60.000	108		Supported	Supported
	1280 x 960_85	85.002	85.938	148.500			
1360 x 768	1360 x 768_60	60.015	47.712	85.500		Supported	Supported
1440 x 900	WXGA+_60	59.887	55.935	106.500		Supported	Supported
1400 x 1050	SXGA+_60	59.978	65.317	121.750		Supported	Supported
1600 x 1200	UXGA	60.000	75.000	162.000		Supported	Supported
1680 x 1050	1680 x 1050_60	59.954	65.290	146.250		Supported	Supported
640 x 480@67Hz	MAC13	66.667	35.000	30.240			
832 x 624@75Hz	MAC16	74.546	49.722	57.280			
1024 x 768@75Hz	MAC19	75.020	60.241	80.000			
1152 x 870@75Hz	MAC21	75.06	68.68	100.00			
1920 x 1080@60Hz	1920 x 1080_60	60	67.5	148.5	Supported	Supported	Supported
1920 x 1200@60Hz	1920 x 1200_60 (Reduce Blanking)	59.950	74.038	154.0000	Supported	Supported	Supported
1920 x 1080@120Hz*	1920 x 1080_120 (only HDMI 2.0 supports)	120.00	135.000	297	Supported		
3840 x 2160*	3840 x 2160_30 For 4K2K model	30	67.5	297			
3840 x 2160*	3840 x 2160_60 For 4K2K model (only HDMI 2.0 supports)	60	135	594			



*Only supported by the **LH730**.



The timings showing above may not be supported due to EDID file and VGA graphic card limitations. It is possible that some timings cannot be chosen.

• Video timings

Timing	Resolution	Vertical Frequency (Hz)	Horizontal Frequency (kHz)	Pixel Frequency (MHz)	Supported 3D format			
					Frame Sequential	Frame Packing	Top Bottom	Side by Side
480i	720 (1440) x 480	59.94	15.73	27	Supported			
480p	720 x 480	59.94	31.47	27	Supported			
576i	720 (1440) x 576	50	15.63	27				
576p	720 x 576	50	31.25	27				
720/50p	1280 x 720	50	37.5	74.25		Supported	Supported	Supported
720/60p	1280 x 720	60	45.00	74.25	Supported	Supported	Supported	Supported
1080/24P	1920 x 1080	24	27	74.25		Supported	Supported	Supported
1080/25P	1920 x 1080	25	28.13	74.25				
1080/30P	1920 x 1080	30	33.75	74.25				
1080/50i	1920 x 1080	50	28.13	74.25				Supported
1080/60i	1920 x 1080	60	33.75	74.25				Supported
1080/50P	1920 x 1080	50	56.25	148.5			Supported	Supported
1080/60P	1920 x 1080	60	67.5	148.5	Supported		Supported	Supported
1080/120P*	1920 x 1080	120	135	297	Supported			
2160/24P*	3840 x 2160 (Only HDMI 2.0 supports)	24	54	297				
2160/25P*	3840 x 2160 (Only HDMI 2.0 supports)	25	56.25	297				
2160/30P*	3840 x 2160 (Only HDMI 2.0 supports)	30	67.5	297				
2160/50P*	3840 x 2160 (Only HDMI 2.0 supports)	50	112.5	594				
2160/60P*	3840 x 2160 (Only HDMI 2.0 supports)	60	135	594				



*Only supported by the **LH730**.