

SAMSUNG

User Manual

SBB-SSN SBB-SSNU

The colour and the appearance may differ depending on the product, and the content in the manual is subject to change without prior notice to improve the performance.

© Samsung Electronics

Samsung Electronics owns the copyright for this manual. Use or reproduction of this manual in parts or entirety without the authorization of Samsung Electronics is prohibited. Trademarks other than Samsung Electronics are property of their respective owners.

Table of contents

Before Using the Product

Safety Precautions	5
Safety symbols	5
Electricity and Safety	6
Installation	7
Operation	7
Cleaning	9

Preparations

Checking the Components	10
Parts	11
Control menu	11
Ports	12
Attaching to display	13
Connecting to the Signage Player Box	14
Remote Control	15

Connecting and Using a Source Device

Before Connecting	17
Pre-connection Checkpoints	17
Connecting to an Audio System	17
Connecting the LAN Cable	17
Changing the Input source	18
Source	18
Web Browser	19

Multiple Display Control

Cable Connection	21
RS232C Cable	21
LAN Cable	22
Connection	24
Control Codes	25
Using MDC	28
MDC Programme Installation/Uninstallation	28

Player feature

Player	29
Viewing content	29
When content is running	30
Available menu	30
File Formats Compatible with Player	31
Schedule	35
Clone Product	36
ID Settings	37
Device ID	37
Device ID Auto Set	37
PC Connection Cable	37
Network Status	38
On/Off Timer	39
On Timer	39
Off Timer	40
Holiday Management	40
URL Launcher	41
URL Launcher Settings	42

Table of contents

OnScreen Display

Display Orientation	43
Onscreen Menu Orientation	43
Screen Protection	44
Auto Protection Time	44
Message Display	44
MDC Message	44
Download Status Message	44
Language	45
Reset OnScreen Display	45

Sound Adjustment

Sound Mode	46
Balance	47
Equaliser	47
Auto Volume	47
Reset Sound	47

Network

Network Status	48
Open Network Settings	48
Network Type	48
Network Settings (Wired)	49
Network Settings (Wireless)	51
Use WPS	53
IPv6	53
IPv6 Status	53
Server Network Settings	54
Connect to server	54
MagicInfo Mode	54
Server Access	54
FTP Mode	54
Proxy server	54
Device Name	54

System

Accessibility	55
High Contrast	55
Enlarge	55
Start Setup	56
Time	57
Clock Set	57
NTP Settings	57
DST	57
Power On Delay	57
Power Control	58
Network Standby	58
Power Button	58
Eco Solution	58
Auto Power Off	58
Temperature Control	59
Play via	59
Change PIN	60
Security	61
Safety Lock On	61
Button Lock	61
USB Auto Play Lock	62
Network Port	62
USB Port	62
General	63
Smart Security	63
Frame Rate	63

Table of contents

Empty Storage	63
Reset System	64

Support

Software Update	65
Update Now	65
Contact Samsung	65
Terms & Conditions	65
Reset All	65

Troubleshooting Guide

Requirements Before Contacting Samsung Customer Service Centre	66
Testing the Product	66
Checking the Resolution and Frequency	66
Check the followings.	67

Specifications

General	70
Preset Timing Modes	71

Appendix

Responsibility for the Pay Service (Cost to Customers)	72
Not a product defect	72
A Product damage caused by customer's fault	72
Others	72
Licence	73





Chapter 01







Before Using the Product

Safety Precautions

The following safety instructions are to ensure your personal safety and prevent property damage. Please read the following to ensure the proper use of the product.

Safety symbols

Symbol	Name	Meaning
	Warning	A serious or fatal injury may result if instructions are not followed.
	Caution	Personal injury or damage to properties may result if instructions are not followed.
	Prohibition	Do NOT attempt.
	Instruction	Follow directions.

CAUTION			
RISK OF ELECTRIC SHOCK. DO NOT OPEN.			
CAUTION: TO REDUCE THE RISK OF ELECTRIC SHOCK, DO NOT REMOVE COVER (OR BACK). THERE ARE NO USER SERVICEABLE PARTS INSIDE. REFER ALL SERVICING TO QUALIFIED PERSONNEL.			
	This symbol indicates that high voltage is present inside. It is dangerous to make any kind of contact with any internal part of this product.		AC voltage: Rated voltage marked with this symbol is AC voltage.
	This symbol indicates that this product has included important literature concerning operation and maintenance.		DC voltage: Rated voltage marked with this symbol is DC voltage.
	Class II product: This symbol indicates that a safety connection to electrical earth (ground) is not required.		Caution. Consult instructions for use: This symbol instructs the user to consult the user manual for further safety related information.

Electricity and Safety

 The following images are for reference only. Real-life situations may differ from what is shown in the images.

Warning





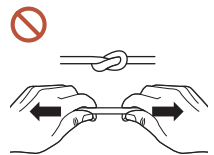

Do not touch the power plug with wet hands. Otherwise, an electric shock may result.

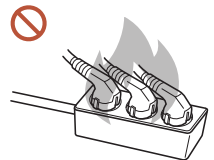

Do not bend or pull the power cable with force. Be careful not to leave the power cable under a heavy object. Product failure, an electric shock or fire may result from a damaged cable.



Do not connect multiple products to a single power socket. Overheated power sockets may cause a fire.

-  Insert the power plug all the way in so it is not loose. An unsecure connection may cause a fire.
-  Clean any dust around the pins of the power plug or the power socket with a dry cloth. A fire may result.
-  Connect the power plug to a grounded power socket. (Except for devices that do not provide grounding) An electric shock or injury may result.
-  Do not use a damaged power plug or a loose power socket. An electric shock or fire may result.

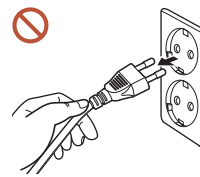

Caution

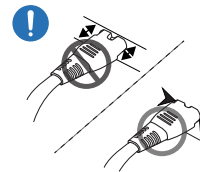

Hold the plug when disconnecting the power cable from the power socket. An electric shock or fire may result.









When connecting the power plug to the port, be sure to connect it completely. If the power plug is not completely connected to the port, the plug may be unexpectedly disconnected, or there is a risk of overheating due to overcurrent, leading to safety accidents.

-  Only use the power cable provided with your product by Samsung. Do not use the power cable with other products. An electric shock or fire may result.
-  Keep the power socket where the power cord is connected unobstructed. When a problem occurs with the product, the power cord must be unplugged to completely cut off power to the product. The power is not completely cut off by using only the Power button on the body of the product.
-  Do not disconnect the power cable while the product is being used. The product may become damaged by an electric shock.









Installation



Warning

-  Before moving the product, turn off the power switch and disconnect the power cable and all other connected cables.
Damage to the cable may cause a fire or electric shock.
-  When installing the product, keep it at a distance from the wall so that it is well ventilated.
An increased internal temperature may cause a fire.
-  If the product is installed in an unusual location, the surrounding environment may cause a serious quality problem. Therefore, be sure to contact Samsung Customer Service Centre before installation.
(Places where many fine dusts are generated, places where chemicals are used, places with too high or low temperatures, places with a lot of moisture or water, transportation equipment such as vehicles, airports and stations used continuously for a long time, and more)
-  Do not install the product in a poorly ventilated space such as bookcase or closet.
An increased internal temperature may cause a fire.
-  Keep the plastic packaging out of the reach of children.
Children's misuse of the plastic packaging may cause suffocation.
-  Do not install the power cable (DC power supply) and the product near heat sources.
(Candles, mosquito repellents, cigarettes, sprays, heating devices, places exposed to direct sunlight, and more)
-  Do not install products on top of each other.
An increased internal temperature may cause a fire.



Operation

Warning

-  If the product generates a strange noise, a burning smell, or smoke, unplug the power plug immediately and contact your Samsung Customer Service Centre.
An electric shock or fire may result.
-  If a gas leakage is found, do not touch the product or the power plug, and ventilate the room immediately.
Sparks can cause an explosion or fire.
-  Keep the remote control batteries and the small accessories out of the reach of children. Ensure children do not swallow any of them.
If children have had the battery in their mouths, consult your doctor immediately.
-  If the product is dropped or its appearance is damaged, turn off the power switch and disconnect the power cord. Then contact Samsung Customer Service Centre.
Continued use can result in an electric shock or a fire.
-  Do not move the product by pulling the power cord or any cable.
Product failure, an electric shock or fire may result from a damaged cable.
-  Ensure the vents are not blocked by tablecloths or curtains.
An increased internal temperature may cause a fire.
-  Do not apply an impact to the product.
 - The screen display may be damaged.
 - An electric shock or fire may result.
-  Do not insert metallic objects (chopsticks, coins, hairpins, etc) or objects that burn easily (paper, matches, etc) into the product (via the vent or input/output ports, etc).
 - If foreign substances enter the product, be sure to power off the product and disconnect the power cord. Then contact Samsung Customer Service Centre.
 - Product failure, an electric shock or fire may result.

-
-  Do not place objects containing liquid (vases, pots, bottles, etc) or metallic objects on top of the product.
 - If foreign substances such as water enter the product, be sure to disconnect the power cord. Then contact Samsung Customer Service Centre.
 - Product failure, an electric shock or fire may result.
 -  During a lightning or thunderstorm, power off the product and disconnect the power cord.

An electric shock or fire may result.
 -  While the power plug is plugged into a power socket, do not insert a chopstick or other conductor into a remaining power socket. Also, after disconnecting the power plug from the power socket, do not touch the pins of the plug immediately.

Otherwise, an electric shock may result.
 -  There is a high voltage inside the product. Never disassemble, repair or modify the product yourself.
 - Contact Samsung Customer Service Centre for repairs.
 - An electric shock or fire may result.
 -  Do not use humidifiers or stoves around the product.

An electric shock or fire may result.





Caution

-  Insert each battery so that its polarity (+, -) is correct.

If the polarity is not correct, the battery may rupture or the internal fluid may leak, causing contamination and damage to the surroundings, fire, or personal injury.
-  When you do not use the product for a long time due to vacation or other reason, disconnect the power cord from the power socket.

Dust accumulation combined with heat can cause a fire, electric shock or electric leakage.
-  The batteries (and rechargeable batteries) are not ordinary refuse and must be returned for recycling purposes. The customer is responsible for returning the used or rechargeable batteries for recycling.

The customer can return used or rechargeable batteries to a nearby public recycling centre or to a store selling the same type of the battery or rechargeable battery.
-  Do not use or keep combustible spray or an inflammable substance near the product.

An explosion or fire may result.
-  Do not place heavy objects on the product.

Product failure or personal injury may result.
-  Use only the specified standardised batteries, and do not use a new battery and a used battery at the same time.

Otherwise, the batteries may be damaged or cause fire, personal injury or damage due to a leakage of the internal liquid.
-  Do not lift or move the product when it is in operation.

Cleaning

Warning

-  Do not spray water or cleaner directly on the product.
 - The product's surface may be damaged, or the markings may be erased.
 - An electric shock or fire may result.

Caution

-  When cleaning, be sure to disconnect the power plug and wipe gently with a soft and dry cloth such as superfine fibers or cotton flannels to prevent scratches.

The product's surface may be damaged, or the markings may be erased.
-  Only use a soft cloth (e.g. microfiber, flannel) on the surface of the product to avoid scratches.

The product's surface or the screen display can be easily scratched with foreign substances.
-  Do not apply chemicals containing alcohol, solvent, or surfactant such as wax, benzene, thinner, pesticide, air freshener, lubricant, or cleaner to the product.

The product's exterior may be discoloured or cracked, the surface of the panel may be peeled off, or the markings may be erased.

Chapter 02

Preparations

Checking the Components

- Contact the vendor where you purchased the product if any components are missing.
- The appearance of the components may differ from the images shown.
- The RS232C adapter can be used to connect using the D-SUB(9-pin) to Stereo type RS232C cable.

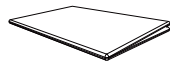

Quick Setup Guide



Warranty card
(Not available in some locations)



Power cord

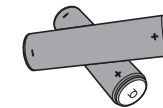

Batteries (AAA x 2)
(Not available in some locations)



Remote Control

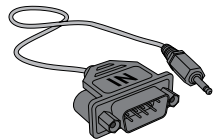

RS232C(IN) adapter



AC/DC adapter

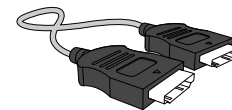

HDMI cable

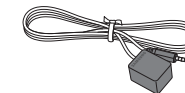

External IR cable

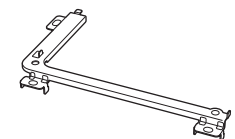

Mount bracket



Foot rubber x 2





Screw (M4 x L8, S-Type) x 5







Screw (M4 x L8, B-Type) x 4

Parts

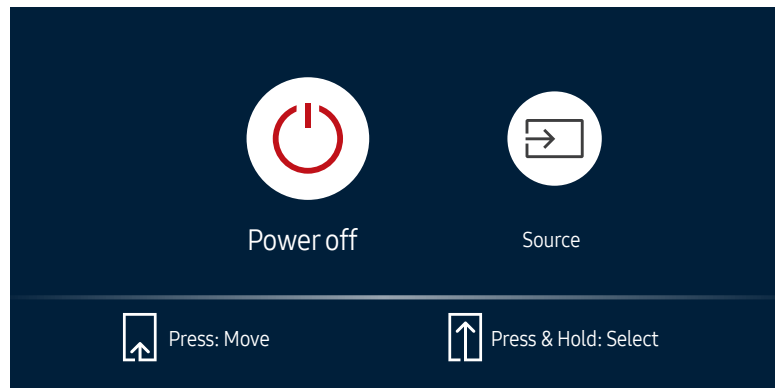
Control menu

 If you press the  button on the product when the product is turned on, the control menu will be displayed.



Buttons	Description
 Power off	<p>Power off the product.</p> <ul style="list-style-type: none">With the control menu screen displayed, briefly press the power button to move the cursor to Power off , and then press and hold the power button to turn off the product.
 Source	<p>Select the connected input source.</p> <ul style="list-style-type: none">With the control menu screen displayed, briefly press the power button to move the cursor to Source , and then press and hold the power button to display the input source screen.With the input source screen displayed, press and hold the power button to switch to the desired input source.



 The power button can only be used for **Power off** and **Source**.

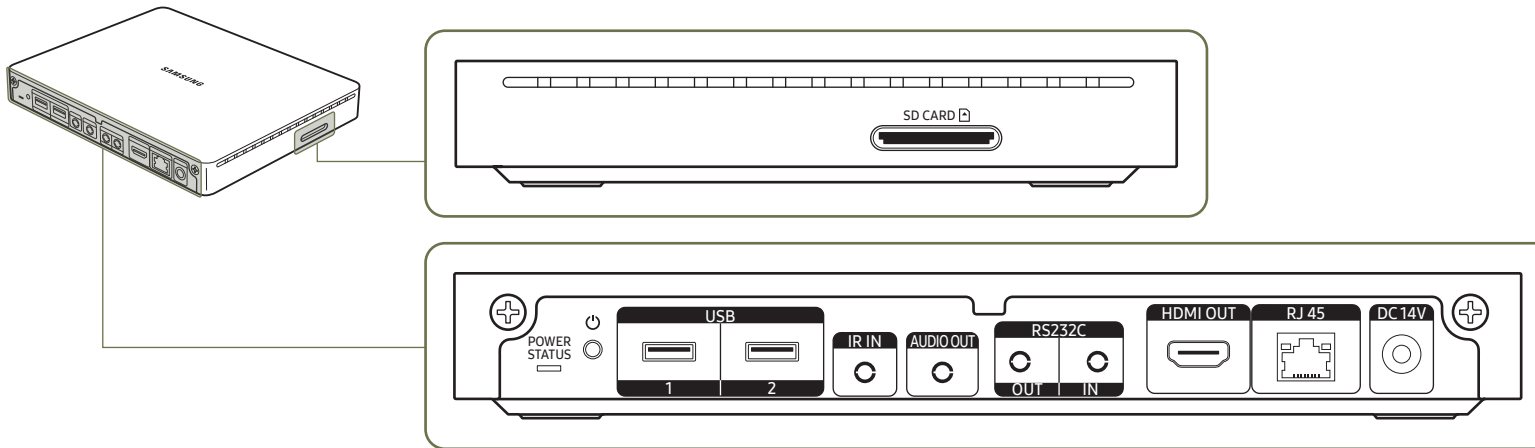

 To exit from the control menu screen, wait for 3 seconds or more without pressing the  button.

Ports

 The colour and shape of parts may differ from what is shown. Specifications are subject to change without notice to improve quality.



Port	Description
POWER STATUS	View the power status of the Signage Player Box.
	Power on or off the Signage Player Box.
USB1, USB 2	<p>Connect to a USB memory device.</p> <p> USB 1: The USB ports on the product accept a maximum constant current of 0.5A. If the maximum value is exceeded, USB ports may not work.</p> <p> USB 2: The USB ports on the product accept a maximum constant current of 1.0A. If the maximum value is exceeded, USB ports may not work.</p>
IR IN	Connect to the external IR cable.
AUDIO OUT	Outputs sound to an audio device via an audio cable.

Port	Description
RS232C OUT	Connects to MDC using an RS232C adapter.
RS232C IN	
HDMI OUT	<p>Connects to another display device, using an HDMI cable.</p> <p> We recommend using authorised cables for HDMI cable connections. Use the supplied HDMI cable.</p>
RJ45	Connects to MDC using a LAN cable. (10/100 Mbps)
DC14V	Connects to the AC/DC adapter.
SD CARD 	<p>Connect to an SD memory card.</p> <p> This function may not be supported depending on the model.</p>

Attaching to display

 The colour and shape of parts may differ from what is shown. Specifications are subject to change without notice to improve quality.

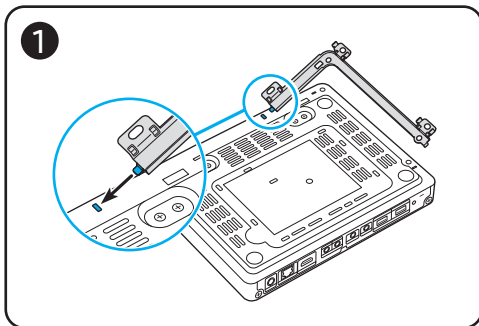
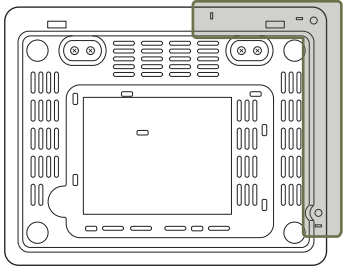

- 1 Align the short side of the mount bracket with the bottom of the Signage Player Box, and push to click in.

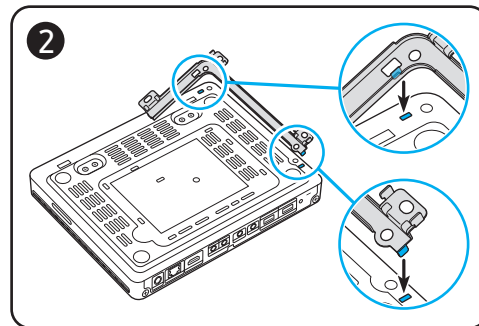

- 2 Continue fitting the other side of the mount bracket.

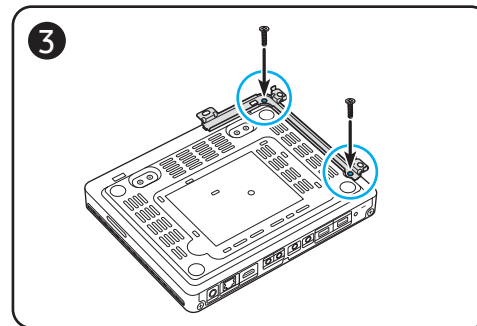

- 3 Fasten the screws (M4 x L8, S-Type).

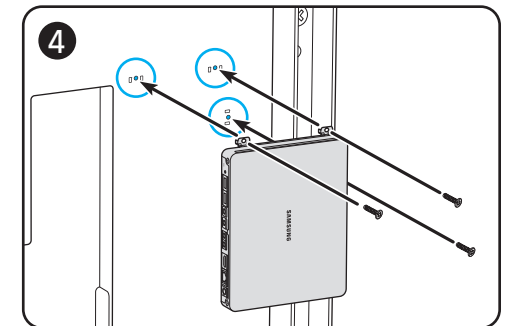



- 4 Position the Signage Player Box on the back of the display and fasten it.

 Use different screws based on the material the backside of display is made of.

- Plastic: M4 x L8, B-Type
- Metal: M4 x L8, S-Type

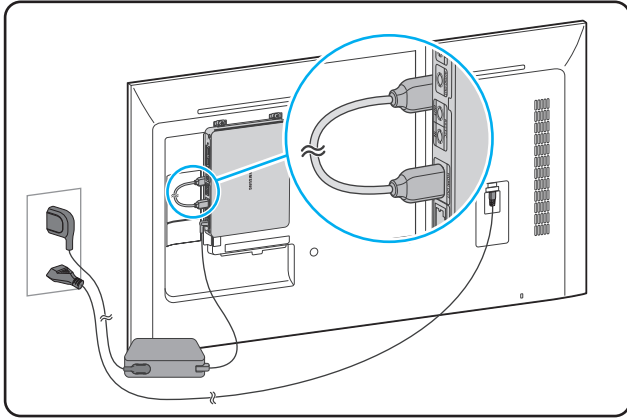
Connecting to the Signage Player Box





- 1 Connect the HDMI cable to the **HDMI OUT** ports on the Signage Player Box and the display.
 - 2 Press the **SOURCE** button on the remote control to change the input source to **HDMI**.
-  To view media in UHD resolution, use the supplied HDMI cable.
 -  The device may generate heat during operation. Need caution.

Remote Control

 Using other display devices in the same space as the remote control of this product can cause the other display devices to be inadvertently controlled.

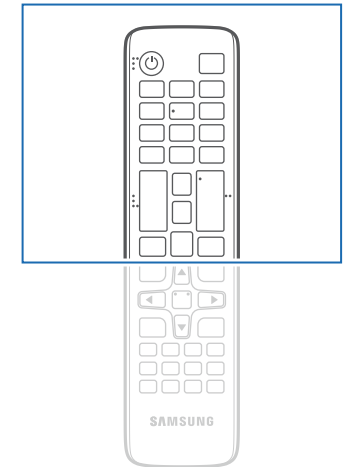
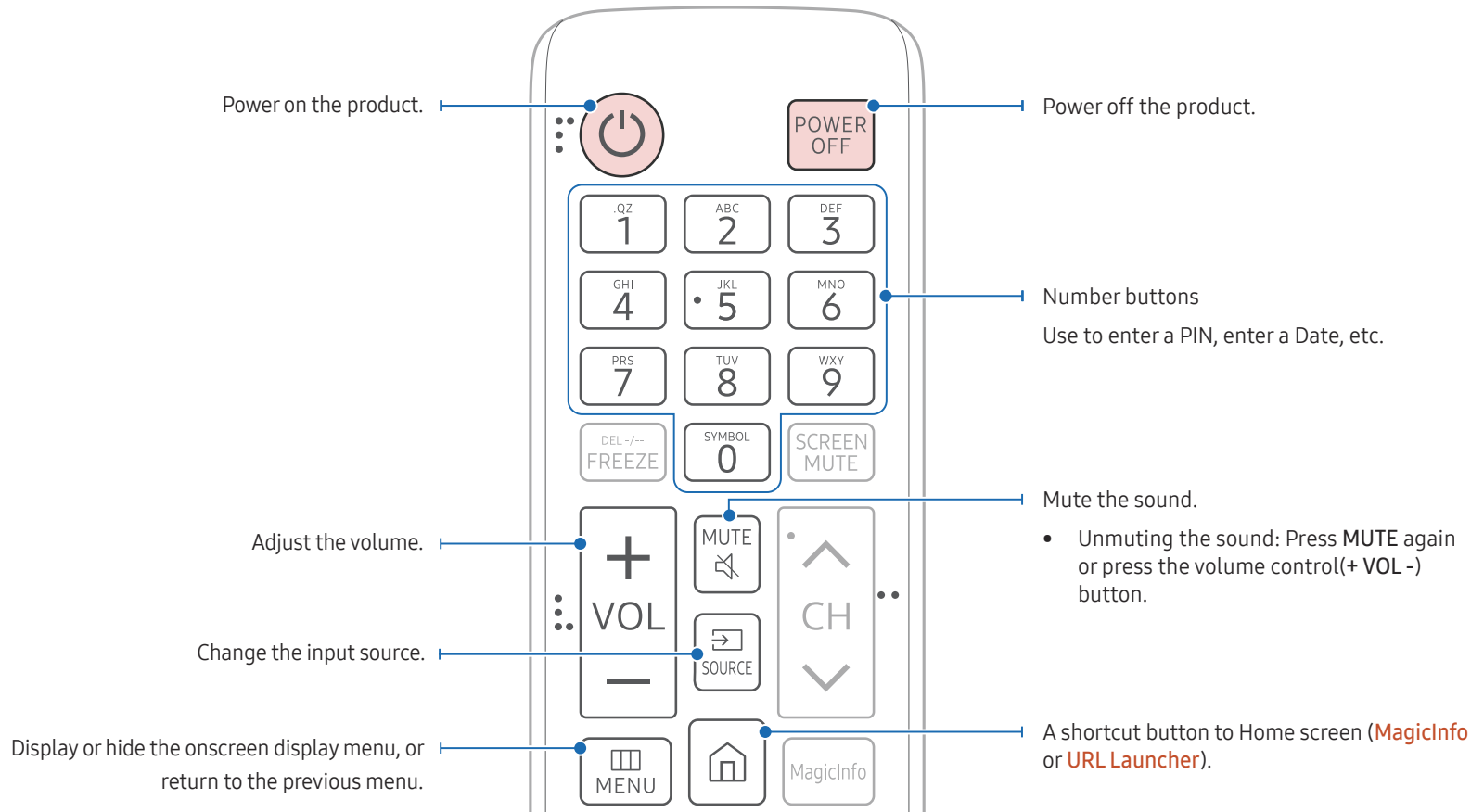
 A button without a description in the image below is not supported on the product.



 Remote control button functions may differ for different products.

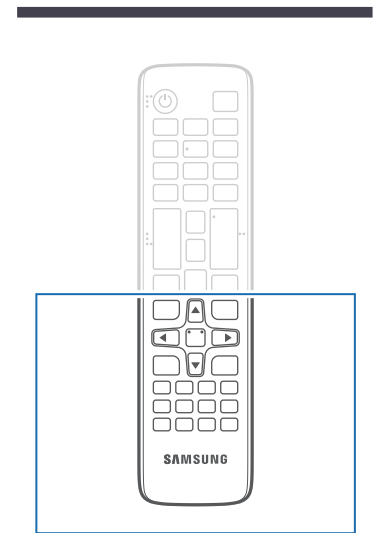
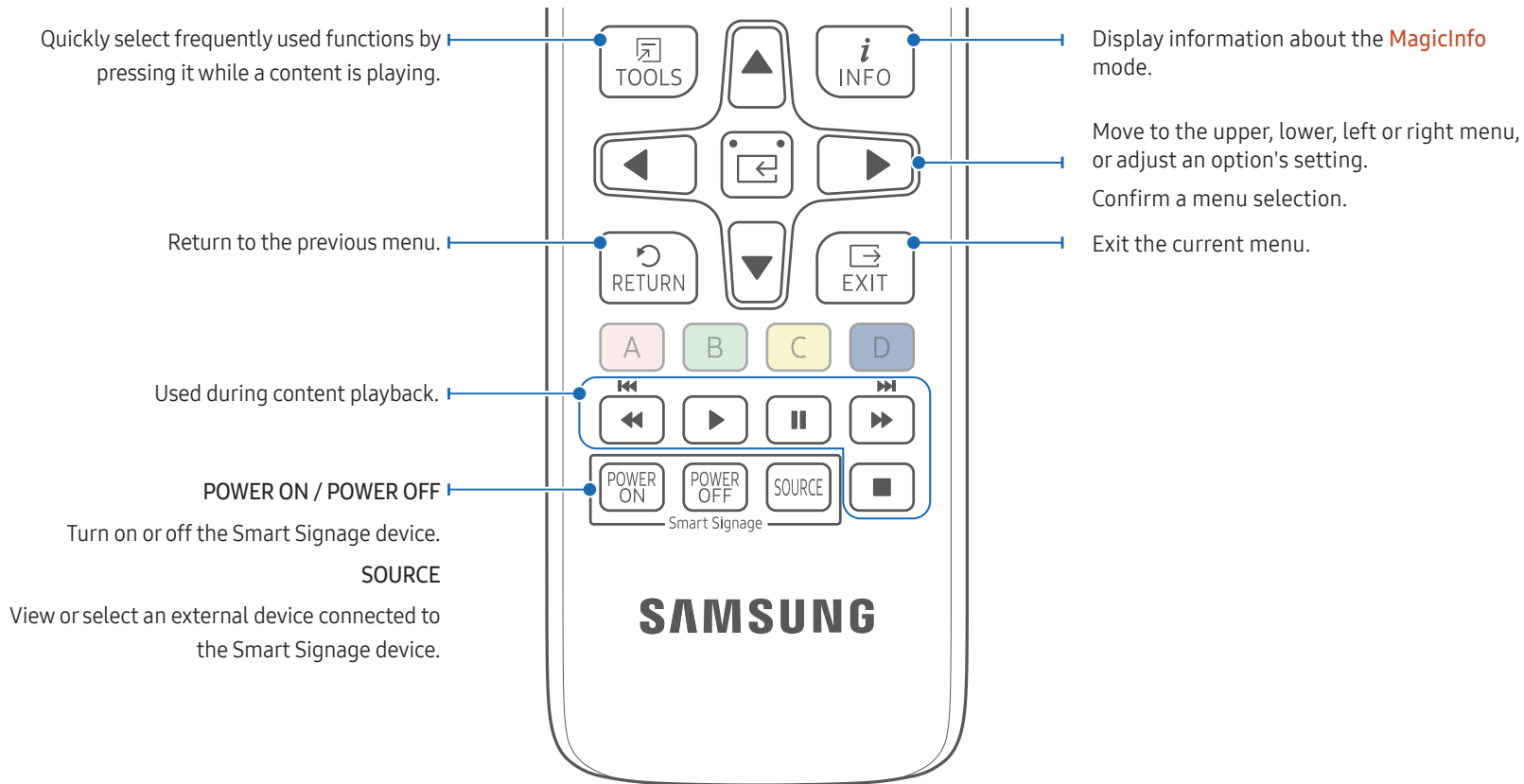

Remote control button functions may differ for different products.

Press a button on the remote control pointing at the sensor of the IR cable to perform the corresponding function.

Use the remote control within 7 m to 10 m from the sensor on the product at an angle of 30° from the left and right.

Store used batteries out of reach of children and recycle.

Do not use a new and used battery together. Replace both batteries at the same time.

Remove batteries when the remote control is not to be used for an extended period of time.

To place batteries in the remote control (AAA x 2)

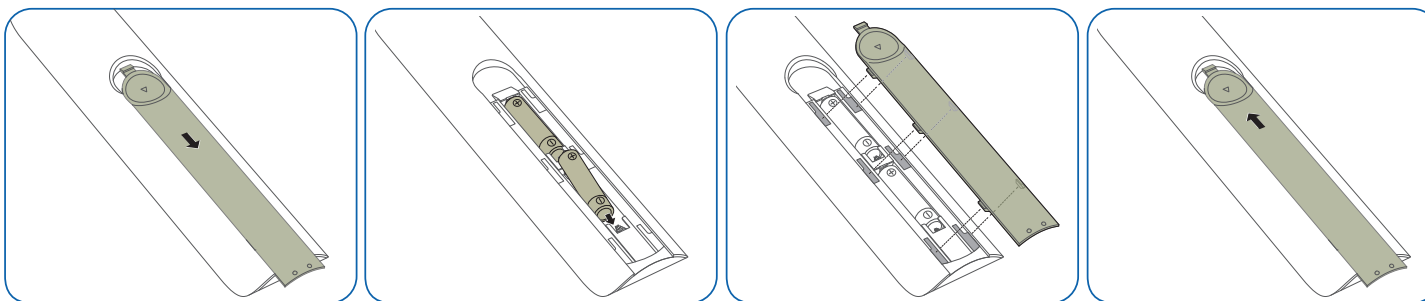

Chapter 03

Connecting and Using a Source Device

Before Connecting

Pre-connection Checkpoints

- ✎ Also refer to the user guide for the source device you want to connect with. The number and location of ports available on the source device may vary.
- ✎ Do not connect the power cable until all connections are completed. Connecting the power cable during connection may damage the product.
- ✎ Check the types of ports at the back of the product you want to connect.

Connecting to an Audio System

- ✎ Connecting parts may differ in different products.
- ✎ Make sure to connect the same colour connectors together. (white to white, red to red, etc.)

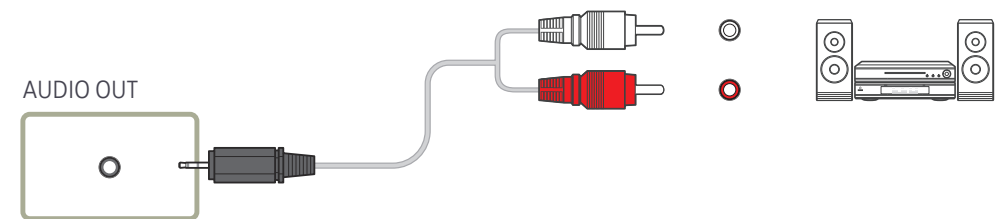

Connecting the LAN Cable

- ✎ Connecting parts may differ in different products.

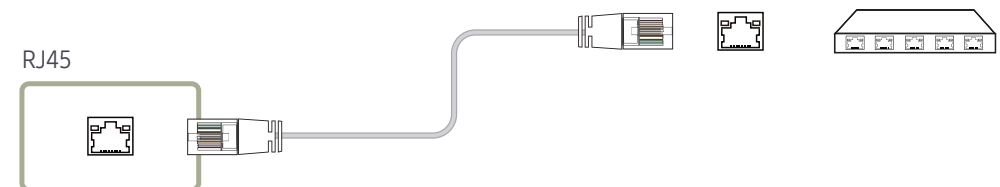

- Use Cat7(*STP Type) cable for the connection. (10/100 Mbps)
*Shielded Twist Pair

Changing the Input source



Source

☒ SOURCE



 The displayed image may differ depending on the model.

You can display the screen of a source device connected to the product. Select a source from source list to display the screen of the selected source.

-  The input source can also be changed by using the **SOURCE** button on the remote control.
-  The screen may not display correctly if an incorrect source is selected for the source device you want to convert to.

- **MagicInfo S / URL Launcher / Web Browser**

Web Browser

☰ SOURCE → 🌐 Web Browser → ↗

🔧 Connect the network to access the Internet from the product like accessing the Internet from a computer.

Settings

☰ SOURCE → 🌐 Web Browser → ▲ → Settings → ↗

Refresh Interval

Set the time for the web browser to wait before returning to the home page.

- Off / 5 min / 10 min / 15 min / 30 min

Zoom

Set the zoom scale to apply when the web browser is refreshed.

- 50% / 75% / 100% / 125% / 150% / 200% / 300%

Home Page

Set the website to display when the web browser is refreshed.

- Samsung Display / Custom

Custom

Enter the URL to set as the home page.

- Enter URL

🔧 Available only when Home Page is set to Custom.

Advanced Settings

General

Hide Tabs and Toolbar automatically	If the browser tabs, menu or toolbar are not used for a while, they will automatically disappear. To make them appear again, move the pointer or focus to the top of the screen. <ul style="list-style-type: none">• Use / Do not use
Hide Cursor in Touch Mode	Hide the cursor to prevent interference with touch operation. <ul style="list-style-type: none">• Use / Do not use
Pop-up Blocker	Make your browsing experience more pleasant by blocking pop-up windows. <ul style="list-style-type: none">• Use / Do not use
Reset Settings	All your customised Web Browser settings will be reset to their default values. Your bookmarks and history won't be affected.

Search Engine

If you enter a keyword in the URL/keyword input field, Web Browser will open the Search Results page. Choose the search engine you want to use.

- Google / Bing

Privacy & Security

Do Not Track	Ask websites not to track you. <ul style="list-style-type: none">• Use / Do not use
Delete History	Delete your entire browsing history.
JavaScript	Allow all sites to run JavaScript for a better browsing experience. <ul style="list-style-type: none">• Use / Do not use
Delete browsing data	Delete all browsing data such as cookies, cached images and data. Your bookmarks and history won't be affected.

Encoding

Encoding	Choose an encoding method for web pages. The current setting is Auto. <ul style="list-style-type: none">• Auto / Manual (Current : Unicode)
----------	---

About

Display the current version of Web Browser.

Chapter 04

Multiple Display Control

Control multiple display devices connected to a PC simultaneously.

Cable Connection

RS232C Cable

Interface	RS232C (9 pins)
Pin	TxD (No.2), RxD (No.3), GND (No.5)
Bit rate	9600 bps
Data bits	8 bit
Parity	None
Stop bit	1 bit
Flow control	None
Maximum length	15 m (only shielded type)

- Pin assignment

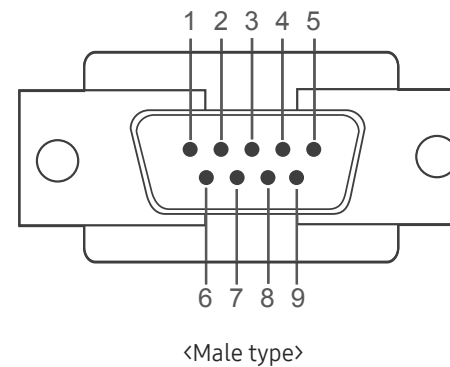

<Male type>

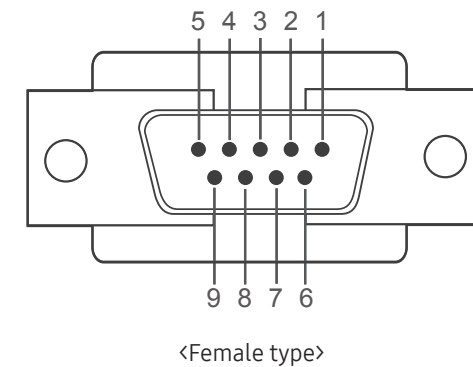

<Female type>

Pin	Signal
1	Detect data carrier
2	Received data
3	Transmitted data
4	Prepare data terminal
5	Signal ground

Pin	Signal
6	Prepare data set
7	Send request
8	Clear to send
9	Ring indicator

- RS232C cable
Connector: 9-Pin D-Sub to Stereo Cable

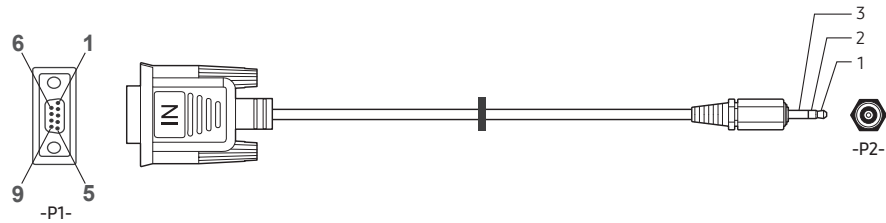

	-P1-			-P2-		
	Rx	3	↔	1	Tx	STEREO
Male type	Tx	2	↔	2	Rx	PLUG
	Gnd	5	↔	3	Gnd	(3.5ø)

LAN Cable

- Pin assignment

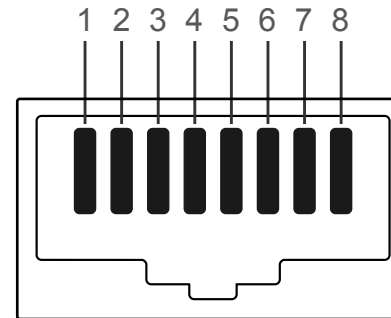

Pin No	Standard Colour	Signal
1	White and orange	TX+
2	Orange	TX-
3	White and green	RX+
4	Blue	NC
5	White and blue	NC
6	Green	RX-
7	White and brown	NC
8	Brown	NC

- Connector : RJ45

Direct LAN cable (PC to HUB)

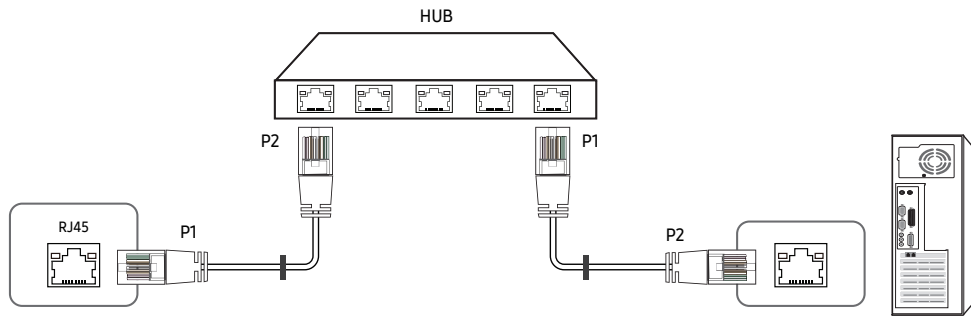

Signal	P1		P2	Signal
TX+	1	↔	1	TX+
TX-	2	↔	2	TX-
RX+	3	↔	3	RX+
RX-	6	↔	6	RX-

Cross LAN cable (PC to PC)

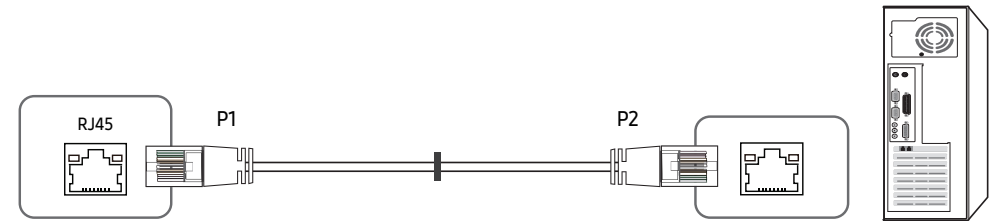

Signal	P1		P2	Signal
TX+	1	↔	3	RX+
TX-	2	↔	6	RX-
RX+	3	↔	1	TX+
RX-	6	↔	2	TX-

Connection

✎ Ensure you connect each of the adapters to the correct RS232C IN or OUT port on the product.

- Connection 1

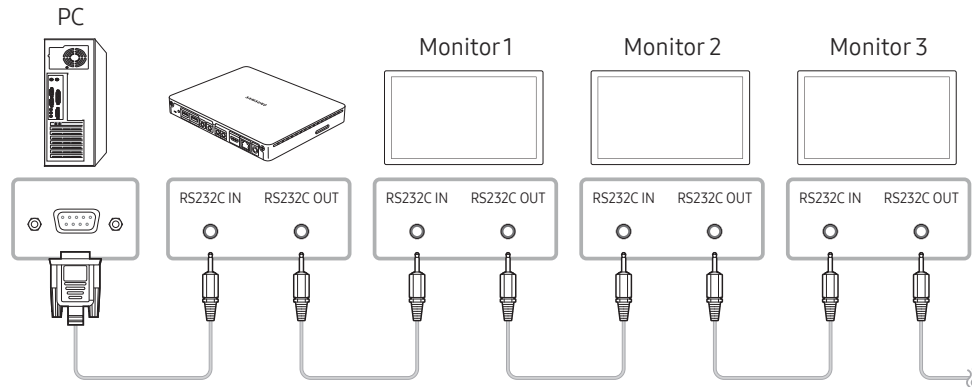

- Connection 2

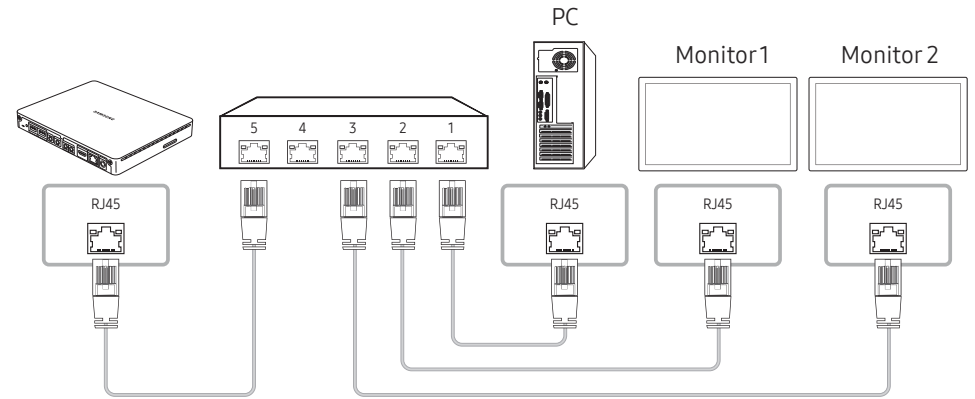

- Connection 3

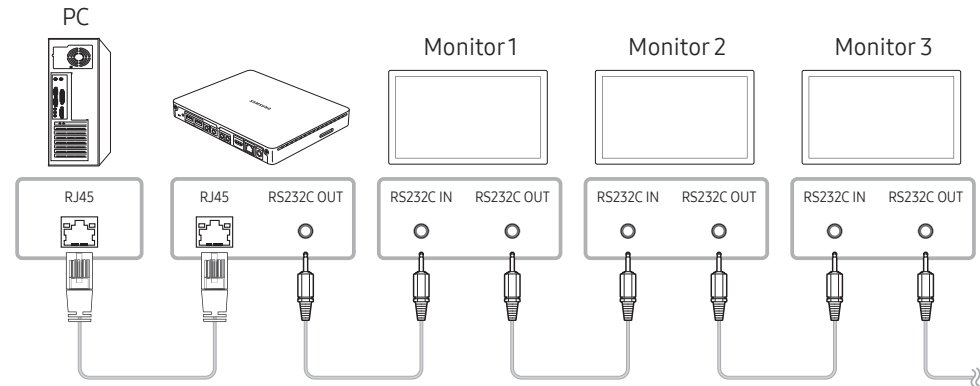

Control Codes

Viewing control state (Get control command)

Header	Command	ID	Data length	Checksum
0xAA	Command type		0	

Controlling (Set control command)

Header	Command	ID	Data length	Data	Checksum
0xAA	Command type		1	Value	

Command

No.	Command type	Command	Value range
1	Power control	0x11	0~1
2	Volume control	0x12	0~100
3	Input source control	0x14	-
4	Safety Lock	0x5D	0~1

- All communications take place in hexadecimals. The checksum is calculated by adding up all values except the header. If a checksum adds up to be more than 2 digits as shown below (11+FF+01+01=112), the first digit is removed.

E.g. Power On & ID=0

Header	Command	ID	Data length	Data 1	Checksum
0xAA	0x11		1	"Power"	

Header	Command	ID	Data length	Data 1	12
0xAA	0x11		1	1	

- To control all devices connected by a serial cable simultaneously irrespective of IDs, set the ID as "0xFE" and transmit commands. Commands will be executed by each device but ACK will not respond.

Power control

- Function
A product can be powered on and off using a PC.
- Viewing power state (Get Power ON / OFF Status)

Header	Command	ID	Data length	Checksum
0xAA	0x11		0	

- Setting power ON/Off (Set Power ON / OFF)

Header	Command	ID	Data length	Data	Checksum
0xAA	0x11		1	"Power"	

"Power": Power code to be set on a product.

1: Power ON

0: Power OFF

- Ack

Header	Command	ID	Data length	Ack/Nak	r-CMD	Val1	Checksum
0xAA	0xFF		3	'A'	0x11	"Power"	

"Power": Power code to be set on a product.

- Nak

Header	Command	ID	Data length	Ack/Nak	r-CMD	Val1	Checksum
0xAA	0xFF		3	'N'	0x11	"ERR"	

"ERR" : A code showing what error has occurred.

Volume control

- Function
The volume of a product can be adjusted using a PC.
- Viewing volume state (Get Volume Status)

Header	Command	ID	Data length	Checksum
0xAA	0x12		0	

- Setting the volume (Set Volume)

Header	Command	ID	Data length	Data	Checksum
0xAA	0x12		1	"Volume"	

"Volume": Volume value code to be set on a product. (0-100)

- Ack

Header	Command	ID	Data length	Ack/Nak	r-CMD	Val1	Checksum
0xAA	0xFF		3	'A'	0x12	"Volume"	

"Volume": Volume value code to be set on a product. (0-100)

- Nak

Header	Command	ID	Data length	Ack/Nak	r-CMD	Val1	Checksum
0xAA	0xFF		3	'N'	0x12	"ERR"	

"ERR" : A code showing what error has occurred.

Input source control

- Function
The input source of a product can be changed using a PC.
- Viewing input source state (Get Input Source Status)

Header	Command	ID	Data length	Checksum
0xAA	0x14		0	

- Setting the input source (Set Input Source)

Header	Command	ID	Data length	Data	Checksum
0xAA	0x14		1	"Input Source"	

"Input Source": An input source code to be set on a product.

0x60	MagicInfo S
0x65	Web Browser
0x63	URL Launcher

 DVI_video, HDMI1_PC and HDMI2_PC cannot be used with the Set command. They only respond to "Get" commands.

- Ack

Header	Command	ID	Data length	Ack/Nak	r-CMD	Val1	Checksum
0xAA	0xFF		3	'A'	0x14	"Input Source"	

"Input Source": An input source code to be set on a product.

- Nak

Header	Command	ID	Data length	Ack/Nak	r-CMD	Val1	Checksum
0xAA	0xFF		3	'N'	0x14	"ERR"	

"ERR" : A code showing what error has occurred.

Safety Lock

- Function
PC can be used to turn the **Safety Lock On** function on or off on a product.
This control is available regardless of whether or not the power is turned on.
- Viewing the safety lock state (Get Safety Lock Status)

Header	Command	ID	Data length	Checksum
0xAA	0x5D		0	

- Enabling or disabling safety lock (Set Safety Lock Enable / Disable)

Header	Command	ID	Data length	Data	Checksum
0xAA	0x5D		1	"Safety Lock"	

"Safety Lock": Safety lock code to be set on a product

1: ON

0: OFF

- Ack

Header	Command	ID	Data length	Ack/Nak	r-CMD	Val1	Checksum
0xAA	0xFF		3	'A'	0x5D	"Safety Lock"	

"Safety Lock": Safety lock code to be set on a product

- Nak



Header	Command	ID	Data length	Ack/Nak	r-CMD	Val1	Checksum
0xAA	0xFF		3	'N'	0x5D	"ERR"	

"ERR": A code showing what error has occurred.

Using MDC

Multiple display control "MDC" is an application that allows you to easily control multiple display devices simultaneously using a PC.



For details on how to use the MDC programme, refer to Help after installing the programme. The MDC programme is available on the website. (<http://displaysolutions.samsung.com>)



-  If you press the **On** or **Off** button located at the top left of the screen, the product checks its status for about one minute. To run other commands, try after the one minute.
-  For details on how to connect devices for multiple display control, refer to page [24](#).

MDC Programme Installation/Uninstallation

-  Installing and uninstalling steps can vary depending on the OS.

Installation

-  MDC installation can be affected by the graphics card, mother board and network conditions.
- 1 Click the **MDC Unified** installation programme.
 - 2 Click "**Next**".
 - 3 When the "**Welcome to the InstallShield Wizard for MDC_Unified**" screen appears, click "**Next**".
 - 4 In the "**License Agreement**" window displayed, select "**I accept the terms in the license agreement**" and click "**Next**".
 - 5 In the displayed "**Customer Information**" window, fill out all the information fields and click "**Next**".
 - 6 In the displayed "**Destination Folder**" window, select the directory path you want to install the programme in and click "**Next**".
 -  If the directory path is not specified, the programme will be installed in the default directory path.

- 7 In the displayed "**Ready to Install the Program**" window, check the directory path to install the programme in and click "**Install**".
- 8 Installation progress will be displayed.
- 9 Click "**Finish**" in the displayed "**InstallShield Wizard Complete**" window.
 -  Select "**Launch the program**" and click "**Finish**" to run the MDC programme immediately.
- 10 The **MDC Unified** shortcut icon will be created on the desktop after installation.
 -  The MDC execution icon may not be displayed depending on the PC system or product specifications.
 -  Press F5 if the execution icon is not displayed.

Uninstallation

- 1 Select **Settings** → **Control Panel** on the **Start** menu and double-click **Add/Delete Program**.
- 2 Select **MDC Unified** from the list and click **Change/Remove**.

Chapter 05

Player feature

Accessible using the  button on the remote control.



Player

 → **Player** → 

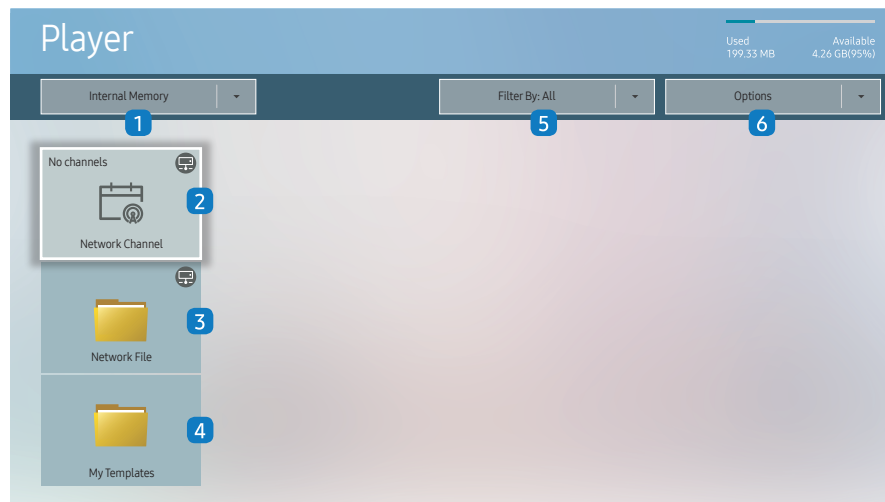
Play a range of content such as channels with schedules assigned, templates or files.



 The displayed image may differ depending on the model.

 To use the **Player** feature, set **Play via** to **MagicInfo** in **System**.
( MENU → **System** → **Play via** → **MagicInfo**)

 You must set **Clock Set** before you can use this feature.

No.	Description
1	Select between internal or external memory.
2	Play content, templates and schedules configured on the server. <ul style="list-style-type: none"> You can view whether the server is connected (approval) in the Player screen. To view whether the server is connected when a Network Channel is running, press INFO on the remote control. <ol style="list-style-type: none"> Select Network Channel from the Player screen. The No channels message appears if no channel has been registered in Network Channel. Network Channel will run.
3	Play content stored on the server.
4	Play templates stored in My Templates folder in the Internal Memory.
5	Select a content type as criterion to search for a desired content list.
6	Set different options for Player .

Viewing content

- Select either internal or external memory. The files saved in the selected memory appear.
- Select the desired file. The content appears on the screen. (For more information on compatible file formats, see the "File formats compatible with Player" section.)

When content is running

Control buttons on the remote control

You can play, pause, or skip the content on the playlist by pressing buttons on the remote control.

Button	Function
TOOLS	Brings up the menu bar.
INFO	Displays the general information of the content.
▶	Goes to next file or page.
◀	Goes to previous file or page.
◀ / ▶ / ⏸	Plays or pauses slide show or video content.
■	Stops displaying content and goes to the Player screen.
◀◀	Rewinds the video content.
▶▶	Fast forwards the video content.

 If there is only one image file in the Internal Memory or USB, the Slide Show will not play.

 If the name of a folder is too long on the USB, you cannot select the folder.

Available menu

Press the TOOLS button on the remote control during content playback to configure settings.

Menu	Description
Playlist	View a list of content items currently playing.
Channel List	Network Channel / Internal Channel / USB
Sound Mode	Customises the audio settings for the content currently playing.
Repeat All / Repeat One	Set the repeat mode.
Background Music	Set the background music to be played when content is running.
Reset	Reset the background music.
Pause	Pause the background music.
Prev	Play the previous background music on the list.
Next	Play the next background music on the list.

 **Reset, Pause, Prev, Next** only appear when the background music is set.

File Formats Compatible with Player

- Supported file systems include FAT32 and NTFS.
- A file with a vertical and horizontal resolution larger than the maximum resolution cannot be played. Check the vertical and horizontal resolution of the file.
- Check the supported video and audio Codec types and Versions.
- Check the supported file versions.
 - ✎ PowerPoint version up to 97 – 2013 is supported
- ✎ For USB-**Internal Memory** file transfer, click **Options** → **Send**.
 - Location of template files
 - **Internal Memory** → USB transfer: USB → under MagicinfoSlide folder
 - USB → **Internal Memory** transfer: **Internal Memory** → under My Templates folder
 - Location of other files (non-template)
 - **Internal Memory** → USB transfer: USB → under MagicinfoSlide folder
 - USB → **Internal Memory** transfer: Under the root folder

Network Schedule Multiframe

Playback restrictions



- 1 to 3 FHD video files can be played simultaneously or only one UHD video file and one FHD video file at a time. In portrait playback mode, 3 FHD video files can be played simultaneously or only one UHD video file at a time.
- For **Office** files (PPT and Word files) and **PDF** files, only one file type is supported at a time.
- LFD(*.LFD) files are not supported.

Sound output restrictions

- More than one sound output cannot be used.
- Playback priority: network BGM → local BGM → video file in the main frame selected by the user
 - ✎ Network BGM: Settings can be configured when creating a server schedule.
 - ✎ Local BGM: BGM settings can be configured using the tools displayed after the **TOOLS** button is pressed during **Player** playback.
 - ✎ User-selected main frame: Main frame settings can be configured when creating a server schedule.

Template files(*.LFD)

Restrictions

- Check that you have **Contents** and **Schedules** folders published to the USB storage device.
 - ✎ A properly published content appears as Published Content  in the USB device.
 - ✎ When copying a content you published to a USB device (Published Content ) to the **Internal Memory**, the content appears in **Internal Memory** as Published Content  only. Contents and Schedules folders are not visible under **Internal Memory**.

Playback restrictions

- A maximum of two video (**Video**) files can be played.
- For **Office** files (PPT and Word files) and **PDF** files, only one file type is supported at a time.
- When playing more than one video files simultaneously, make sure that the display areas are not overlapping one another.

Sound output restrictions

- More than one sound output cannot be used.
- Playback priority: network BGM → local BGM → video file in the main frame selected by the user

Content

File Extension	Container	Video Codec	Resolution	Frame rate (fps)	Bit rate (Mbps)	Audio Codec
*.avi	AVI MKV ASF MP4 3GP MOV FLV VRO VOB PS TS SVAF	H.264 BP/MP/HP	4096x2160	4096x2160: 30	60	AC3 LPCM ADPCM(IMA, MS) AAC HE-AAC WMA DD+ Dolby TrueHD MPEG(MP3) G.711(A-Law, μ -Law) OPUS
*.mkv				3840x2160: 60		
*.asf		HEVC (H.265 - Main, Main10)		60	80	
*.wmv		Motion JPEG	3840x2160	30	80	
*.mp4		MVC	1920x1080	60	20	
*.mov		MPEG4 SP/ASP				
*.3gp		Window Media Video v9 (VC1)				
*.mpg		MPEG2				
*.mpeg		MPEG1				
*.trp		Microsoft MPEG-4 v1, v2, v3		30		
*.tp		Window Media Video v7(WMV1), v8(WMV2)				
*.trp		H 263 Sorenson				
*.mov		VP6				
*.flv						
*.vob						
*.svi						
*.m2ts						
*.mts						
*.webm	WebM	VP8	1920x1080	60	20	Vorbis
		VP9	3840x2160	3840x2160: 60	80	
*.rmvb	RMVB	RV8/9/10 (RV30/40)	1920x1080	60	20	RealAudio 6

Video	Audio	Image
<ul style="list-style-type: none"> • 3D video is not supported. • Content with a resolution larger than the resolution specified in the table above is not supported. • Video content with a Bit rate or Frame rate larger than the rate specified in the table above can cause choppy video during playback. • Video content will not play, or not play correctly, if there is an error in the content or the container. • Some USB/digital camera devices may not be compatible with the player. • Supports up to H.264, Level 4.1 • H.264 FMO / ASO / RS, VC1 SP / AP L4 and AVCHD are not supported. • For all Video codecs except MVC, VP8, VP6: <ul style="list-style-type: none"> – Below 1280 x 720: 60 frame max – Above 1280 x 720: 30 frame max • GMC 2 or higher is not supported. • Supports only BD MVC Spec. • When a single video file is playing, Seamless mode is not supported under the following conditions: <ul style="list-style-type: none"> – Incompatible codec (MVC, VP3, MJPEG) ↔ Incompatible codec – Incompatible codec ↔ Compatible codec – The resolution is different from that of the monitor – The frequency is different from that of the monitor 	<ul style="list-style-type: none"> • Audio content with a Bit rate or Frame rate larger than the rate specified in the table above can cause choppy audio during playback. • Audio content will not play, or not play correctly, if there is an error in the content or the container. • Some USB/digital camera devices may not be compatible with the player. • Supports up to WMA 10 Pro 5.1 channel. WMA lossless audio is not supported. • QCELP, AMR NB/WB are not supported. 	<ul style="list-style-type: none"> • Compatible image file format: JPEG, PNG, BMP <ul style="list-style-type: none">  32-bit, 24-bit and 8-bit BMP files are supported. • Supported maximum resolution: 4096 x 4096 • Supported maximum file size: 20MB • Supported Slideshow Effect: 9 effects (Fade1, Fade2, Blind, Spiral, Checker, Linear, Stairs, Wipe, Random)

Power Point	PDF	WORD
<ul style="list-style-type: none"> • Compatible document file formats <ul style="list-style-type: none"> – Extension : ppt, pptx – Version : Office 97 ~ Office 2013 • Functions not supported <ul style="list-style-type: none"> – Animation effect – 3D shapes (which will be displayed in 2D) – Header and footer (some subitems are not supported) – Word Art – Align <ul style="list-style-type: none"> A group alignment error may occur – Office 2007 <ul style="list-style-type: none"> SmartArt is not fully supported. 97 out of 115 subitems are supported. – Object insertion – Half-width characters – Letter spacing – Charts – Vertical text <ul style="list-style-type: none"> Some subitems are not supported – Slide notes and handout 	<ul style="list-style-type: none"> • Compatible document file formats <ul style="list-style-type: none"> – Extension : pdf • Functions not supported <ul style="list-style-type: none"> – Content less than 1 pixel not supported because of performance degradation issue. – Masked Image, Tiled Image content not supported. – Content with Rotated Text, not supported. – 3D Shadow Effects not supported. – Some characters not supported <ul style="list-style-type: none"> (Special characters may be corrupted) 	<ul style="list-style-type: none"> • Compatible document file formats <ul style="list-style-type: none"> – Extension : .doc, .docx – Version : Office 97 ~ Office 2013 • Functions not supported <ul style="list-style-type: none"> – Page background effect – Some paragraph styles – Word Art – Align <ul style="list-style-type: none"> A group alignment error may occur – 3D shapes (which will be displayed in 2D) – Office 2007 <ul style="list-style-type: none"> SmartArt is not fully supported. 97 out of 115 subitems are supported. – Charts – Half-width characters – Letter spacing – Vertical text <ul style="list-style-type: none"> Some subitems are not supported – Slide notes and handout

Schedule

Home → Schedule →

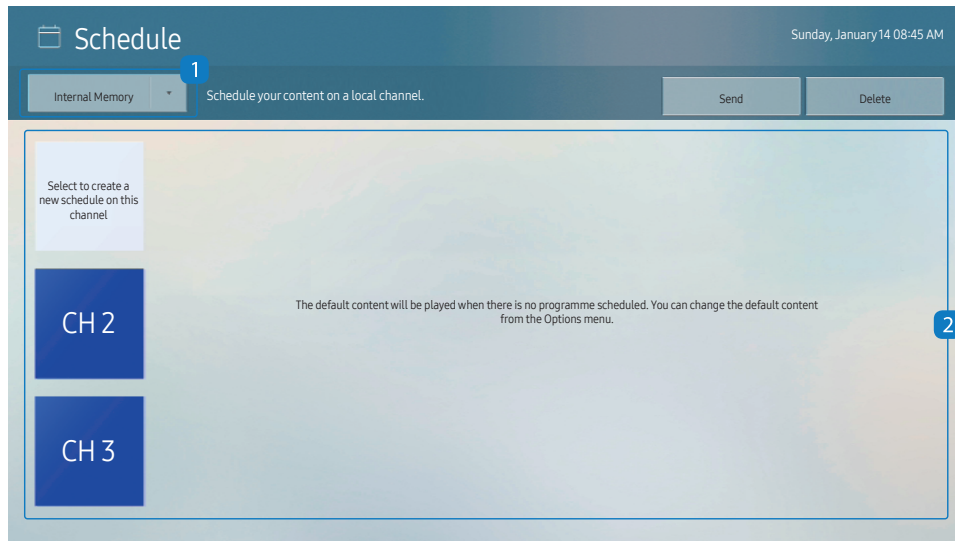

The displayed image may differ depending on the model.

You can check the schedule imported from a selected storage device.

No.	Description
1	Select the saved location of the schedule.
2	Create/Edit/Delete/View schedule of content playback.

Clone Product

🏠 → Clone Product → 🗑️

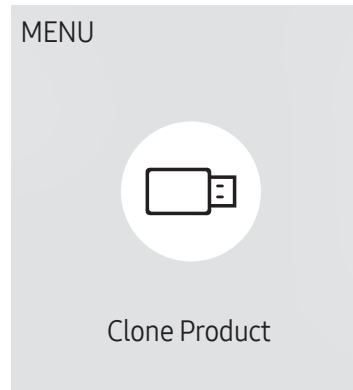

 The displayed image may differ depending on the model.

Export settings on the product to an external storage device. You can also import settings from an external storage device.

This option is useful when assigning the same settings to several products.

When a duplicate file is not found on the external storage device

- 1 Connect the external storage device, then run the **Clone Product** function.
- 2 The **No cloning file found on the external storage device. Export this device's settings to the external storage device?** message appears.
- 3 Select **Export** to export the settings.

When a duplicate file is found on the external storage device

- 1 Connect the external storage device, then run the **Clone Product** function.
 - 2 The **Cloning file found. Please select an option.** message appears.
Run the **Import from External Storage** or **Export to External Storage** function.
 - **Import from External Storage:** Copy settings saved on an external storage device to the product.
 - **Export to External Storage:** Copy settings on the product to an external storage device.
-  After configuration is complete, the product is rebooted automatically.

ID Settings

🏠 → ID Settings → 📄

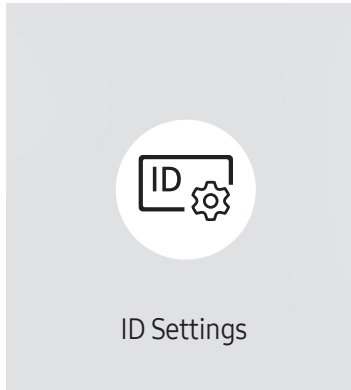

✎ The displayed image may differ depending on the model.

Assign an ID to a set.

Device ID

Set a unique ID number for each product. (Range: 0~224)

✎ Press ▲/▼ to select a number, and press ↵.

✎ Enter the number you want using the number buttons on the remote control.

Device ID Auto Set

This feature automatically allots an ID number to a device connected via an RS232C cable.

✎ This function is only available on the first device within an RS-232C daisy chain.

PC Connection Cable

Select which type of cable you are using to connect the display to the PC.

- **RS232C cable**
Communicate with MDC via the RS232C cable.
- **RJ-45 (LAN)/Wi-Fi Network**
Communicate with MDC via the RJ45 cable.

Network Status

Check the current network and Internet connection.

 → [Network Status](#) → 

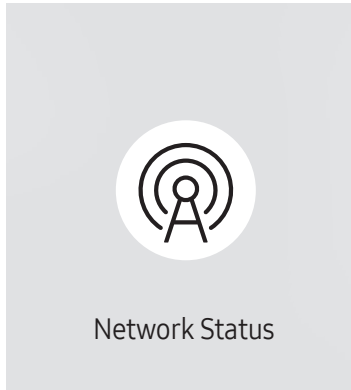

 The displayed image may differ depending on the model.

On/Off Timer

🏠 → On/Off Timer → 📄

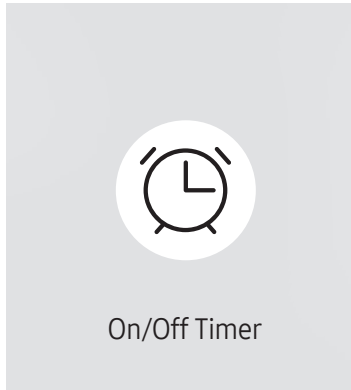

 The displayed image may differ depending on the model.

 You must set **Clock Set** before you can use this feature.

On Timer

Set **On Timer** so that your product turns on automatically at a time and on a day of your choice.

The power is turned on with the specified volume or input source.

On Timer: Set the on timer by making a selection from one of the seven options. Ensure you set the current time first.

(**On Timer1 ~ On Timer7**)

 While the internal/USB memory option can be used with **On Timer** for **MagicInfo** mode, it is recommended to use an internal memory.

 Proper operation of **On Timer** feature cannot be guaranteed if used with a battery powered USB device, which can take longer to be recognised.

- **Setup:** Select **Off**, **Once**, **Everyday**, **Mon~Fri**, **Mon~Sat**, **Sat~Sun** or **Manual**. If you select **Manual**, you can choose the days you want **On Timer** to turn on your product.
 - The check mark indicates days you've selected.
- **Time:** Set the hour and minute. Use the number buttons or the up and down arrow keys to enter numbers. Use the left and right arrow buttons to change entry fields.
- **Volume:** Set the desired volume level. Use the up and down arrow buttons to change the volume level.
- **Source:** Select the input source of your choice.
- **Content** (when the **Source** is set to **Internal/USB** for **MagicInfo** mode): From the USB device or internal memory, select a file (e.g. music, photo, or video) to play just after the product is turned on.

Off Timer

Set the off timer (**Off Timer**) by making a selection from one of the seven options. (**Off Timer 1 ~ Off Timer 7**)

- **Setup:** Select **Off**, **Once**, **Everyday**, **Mon~Fri**, **Mon~Sat**, **Sat~Sun** or **Manual**. If you select **Manual**, you can choose the days you want **Off Timer** to turn off your product.
 - The check mark indicates days you've selected.
- **Time:** Set the hour and minute. Use the number buttons or the up and down arrow keys to enter numbers. Use the left and right arrow buttons to change entry fields.

Holiday Management

Timer will be disabled during a period specified as a holiday.

- **Add Holiday:** Specify the period you want to add as a holiday.
Select the start and end dates of the holiday you want to add using the ▲/▼ buttons, and click the **Done** button.
The period will be added to the list of holidays.
 - **Start Date:** Set the start date of the holiday.
 - **End Date:** Set the end date of the holiday.
- **Delete:** Delete selected items from the list of holidays.
- **Edit:** Select a holiday item and then change the date.
- **Set Applied Timer:** Set the **On Timer** and **Off Timer** to not activate on public holidays.
 - Press to select the **On Timer** and **Off Timer** settings you do not want to activate.
 - The selected **On Timer** and **Off Timer** will not activate.

URL Launcher

🏠 → URL Launcher → 📄

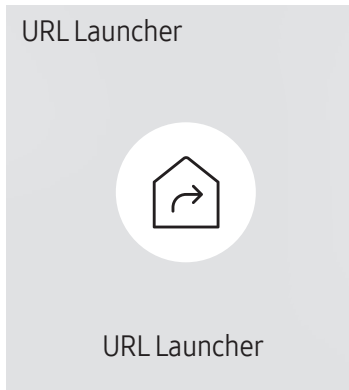

 The displayed image may differ depending on the model.

For details on how to use the **URL Launcher** feature, contact the dealer the product was purchased from.

 To use the **URL Launcher** feature, set **Play via** to **URL Launcher** in **System**.

(☰ MENU → **System** → **Play via** → **URL Launcher**)

URL Launcher Settings

🏠 → URL Launcher Settings → ⏪

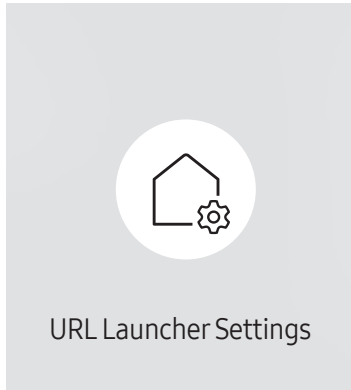

 For details on how to use the **URL Launcher** feature, contact the dealer the product was purchased from.

- **Install Web App:** Enter URL to install the web application.
- **Install from USB Device:** Install the web application from the USB storage device.
- **Uninstall:** Remove the installed web application.
- **Timeout Setting:** Set the timeout period for connecting to the URL.
- **Developer Mode:** Enable developer mode.

 The displayed image may differ depending on the model.

Chapter 06

OnScreen Display

Display Orientation

☰ MENU → OnScreen Display → Display Orientation → ↩

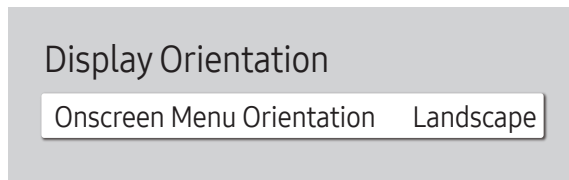

 The displayed image may differ depending on the model.

Onscreen Menu Orientation

Select whether the onscreen menu should be displayed in landscape or portrait orientation.

- **Landscape:** Display the menu in landscape mode.
- **Portrait:** Display the menu in portrait mode on the right side of the product screen.

Screen Protection

☰ MENU → OnScreen Display → Screen Protection → 



 The displayed image may differ depending on the model.

Message Display

☰ MENU → OnScreen Display → Message Display → 

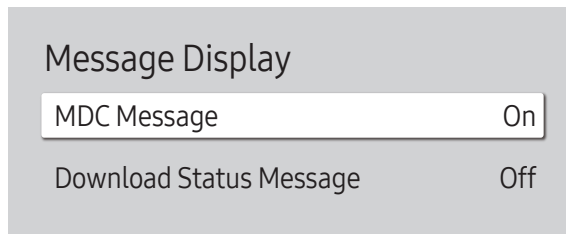

 The displayed image may differ depending on the model.

Auto Protection Time

If the screen displays a still image for a certain period of time you define, the product activates the screen saver to prevent the formation of burnt in ghost images on the screen.

- Off / 2 hours / 4 hours / 6 hours / 8 hours / 10 hours

MDC Message

Select whether to display the MDC OSD when the product is controlled by the MDC.

- Off / On

Download Status Message

Select to display the status when downloading content from a server or other device.

- Off / On

Language

☰ MENU → OnScreen Display → Language → ↩

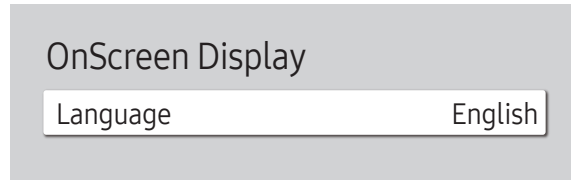

 The displayed image may differ depending on the model.

Set the menu language.

 A change to the language setting will only be applied to the onscreen menu display. It will not be applied to other functions on your PC.

Reset OnScreen Display

☰ MENU → OnScreen Display → Reset OnScreen Display → ↩

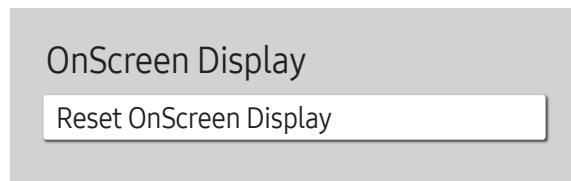

 The displayed image may differ depending on the model.

This option returns the current settings under **OnScreen Display** to the default factory settings.

Chapter 07

Sound Adjustment

Configure the **Sound** settings for the product.

Sound Mode

☰ MENU → **Sound** → **Sound Mode** → ⏪

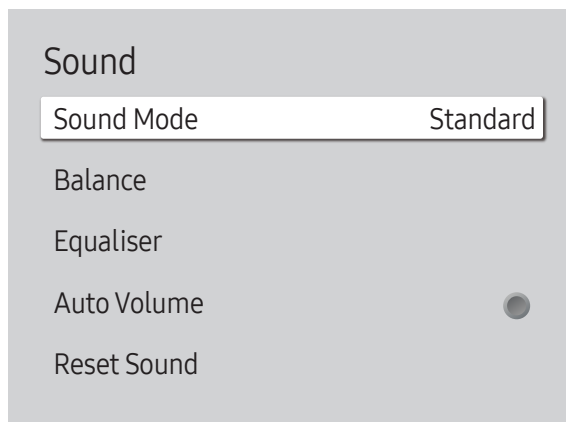

 The displayed image may differ depending on the model.

You can select a sound mode to suit your personal preferences.

- **Standard**: Selects the normal sound mode.
- **Music**: Emphasises music over voices.
- **Movie**: Provides the best sound for movies.
- **Clear Voice**: Emphasises voices over other sounds.
- **Amplify**: Increase the intensity of high-frequency sound to allow a better listening experience for the hearing impaired.

Balance

☰ MENU → Sound → Balance → 

Adjust speaker volume levels for sound balance optimisation.

- **Balance L/R:** Adjusts the balance between the left and right speaker.
- **Reset:** Resets the balance to its default settings.

Equaliser

☰ MENU → Sound → Equaliser → 

Adjust the equaliser to customise the volume and pitch, and enhance the richness of the sound output.

- **100 Hz / 200 Hz / 500 Hz / 1 kHz / 2 kHz / 5 kHz / 10 kHz** (Bandwidth Adjustment): Adjusts the level of specific bandwidth frequencies.
- **Reset:** Resets the equaliser to its default settings.

 Available only when **Sound Mode** is set to **Standard**

Auto Volume

☰ MENU → Sound → Auto Volume → 

Automatically adjusts the volume level when you change video sources or content so the level remains the same.

- **Off** (●) / **On** (●)

 To use the volume control of a connected source device, set **Auto Volume** to **Off**.

Reset Sound

☰ MENU → Sound → Reset Sound → 

Reset all sound settings to the factory defaults.

Chapter 08

Network

Network Status

☰ MENU → Network → Network Status → ↗

You can check the current network and Internet status.

Open Network Settings

☰ MENU → Network → Open Network Settings → ↗

Configure network settings to connect to an available network.

Network Type

- Wireless / Wired

Network Settings (Wired)

Connecting to a Wired Network

There are three ways to attach your product to your LAN using cable.

- You can attach your product to your LAN by connecting the LAN port on the back of your product to an external modem using a LAN cable. See the diagram below.

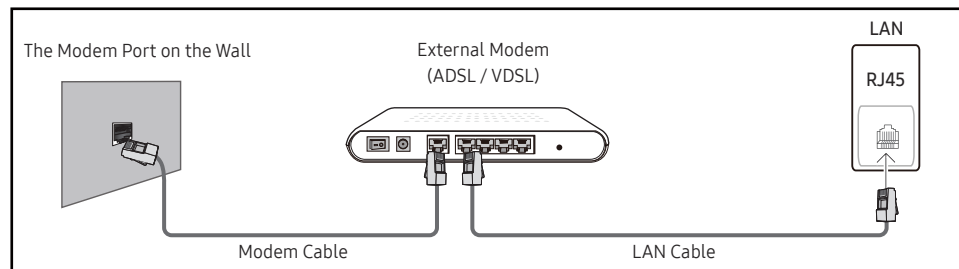

- You can attach your product to your LAN by connecting the LAN port on the back of your product to an IP Sharer which is connected to an external modem. Use LAN cable for the connection. See the diagram below.

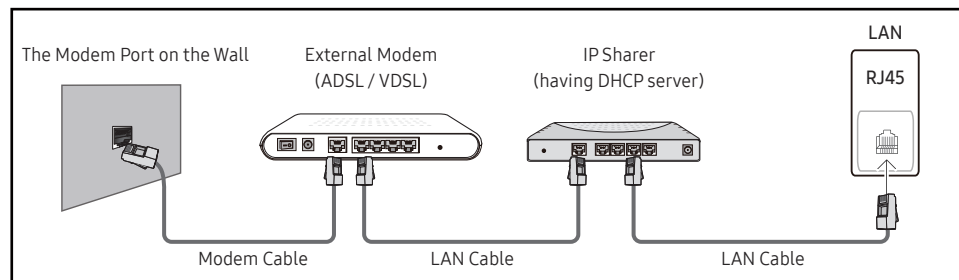

- Depending on how your network is configured, you may be able to attach your product to your LAN by connecting the LAN port on the back of your product directly to a network wall outlet using a LAN cable. See the diagram below. Note that the wall outlet is attached to a modem or router elsewhere in your house.

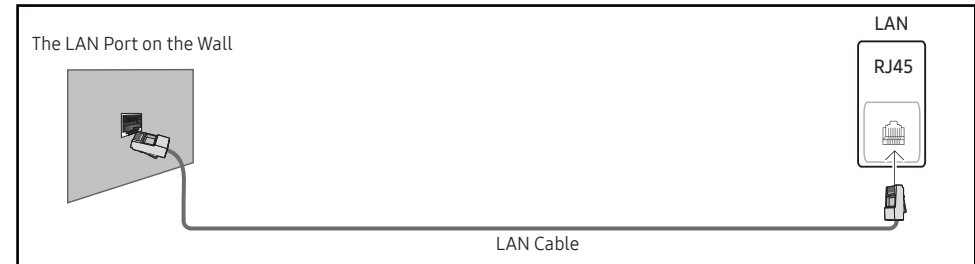

If you have a Dynamic Network, you should use an ADSL modem or router that supports the Dynamic Host Configuration Protocol (DHCP). Modems and routers that support DHCP automatically provide the IP address, subnet mask, gateway, and DNS values your product needs to access the Internet so you do not have to enter them manually. Most home networks are Dynamic Networks.

Some networks require a Static IP address. If your network requires a Static IP address, you must enter the IP address, subnet mask, gateway, and DNS values manually on your product **IP Settings** when you set up the network connection. To get the IP address, subnet mask, gateway, and DNS values, contact your Internet Service Provider (ISP).

If you have a Windows computer, you can also get these values through your computer.

- ✎ You can use ADSL modems that support DHCP if your network requires a Static IP address.
- ✎ ADSL modems that support DHCP also let you use Static IP addresses.



Set the network connection to use Internet services such as perform software upgrades.

Automatic Open Network Settings (Wired)

Connect to the network using a LAN cable.

Make sure a LAN cable is connected first.

How to set up automatically

- 1 Set **Network Type** to **Wired** from the **Open Network Settings** page.
- 2 The network test screen appears and verifies the network connection.
When the connection has been verified, the “**Success! Your device is connected to the Internet. If you have any problems using online services, please contact your Internet service provider.**” message appears.
 If the connection process fails, check the LAN port connection.
 If the automatic process cannot find the network connection values or if you want to set the connection manually, go to the next section(Manual Open Network Settings (Wired)).

Manual Open Network Settings (Wired)

Offices may use static IP addresses.



If this is the case, ask the network administrator for the IP address, subnet mask, gateway and DNS server address. Enter these values manually.

Getting the Network Connection Values

To view the Network connection values on most Windows computers, follow these steps.

- 1 Right click the Network icon on the bottom right of the screen.
- 2 In the pop-up menu that appears, click Status.
- 3 On the dialog that appears, click the **Support** tab.
- 4 On the **Support** Tab, click the **Details** button. The Network connection values are displayed.
 The path to the settings depends on the installed OS.

How to set up manually

- 1 Set **Network Type** to **Wired** from the **Open Network Settings** page.
- 2 The network test screen appears and the verification process starts. Press **Cancel**. The verification process stops.
- 3 Select **IP Settings** on network connection screen. The **IP Settings** screen appears.
- 4 Select the field at the top, press , and then set **IP setting** to **Enter manually**. Repeat the entry process for each field in the **IP Address**.
 Setting **IP setting** to **Enter manually** automatically changes **DNS setting** to **Enter manually**.
- 5 When done, select **OK** at the bottom of the page, and then press . The network test screen appears and the verification process starts.
- 6 When the connection has been verified, the “**Success! Your device is connected to the Internet. If you have any problems using online services, please contact your Internet service provider.**” message appears.

Network Settings (Wireless)

Connecting to a Wireless Network

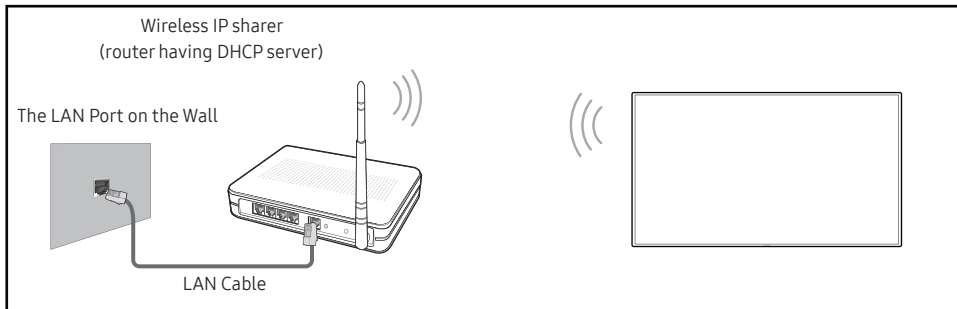

Samsung recommends using IEEE 802.11n. When you play video over a network connection, the video may not play smoothly.

- ✎ Select a channel for the wireless IP sharer that is not currently being used. If the channel set for the wireless IP sharer is currently being used by another device nearby, this will result in interference and communication failure.
- ✎ Your product supports only the following wireless network security protocols. If you select the Pure High-throughput (Greenfield) 802.11n mode and the Encryption type is set to WEP, TKIP or TKIP AES (WPS2Mixed) on your AP or wireless router, Samsung products will not support a connection in compliance with new Wi-Fi certification specifications.
- ✎ If your wireless router supports WPS (Wi-Fi Protected Setup), you can connect to the network via PBC (Push Button Configuration) or PIN (Personal Identification Number). WPS will automatically configure the SSID and WPA key in either mode.
- ✎ Connection Methods: You can setup the wireless network connection in three ways. Auto Setup (Using the Auto Network Search function), Manual Setup, **Use WPS**

Automatic Network Setup (Wireless)

Most wireless networks have an optional security system that requires devices that access the network to transmit an encrypted security code called an Access or **Security Key**. The **Security Key** is based on a Pass Phrase, typically a word or a series of letters and numbers of a specified length you were asked to enter when you set up security for your wireless network. If you use this method of setting up the network connection, and have a **Security Key** for your wireless network, you will have to enter the Pass Phrase during the the automatic or manual setup process.

How to set up automatically

- 1 Set **Network Type** to **Wireless** from the **Open Network Settings** page.
- 2 The **Network** function searches for available wireless networks. When done, it displays a list of the available networks.
In the list of networks, press the ▲ or ▼ button to select a network, and then press the button twice.
 - ✎ If the desired wireless router does not appear, select **Refresh** to search again.
 - ✎ If the router cannot be found after retrying, select the **Stop** button. The **Add Network** button appears.
- 3 If the **Enter the password for (AP Name)** screen appears, go to step 4. If you select a wireless router that does not have security, go to step 6.
- 4 If the router has security, enter the **Enter the password for (AP Name)**. (Security key or PIN).
- 5 When done, use the right arrow button to move the cursor to **Done**, and then press . The network connection screen appears and the verification process starts.
 - ✎ A connection with the router is established, but the Internet cannot be accessed.
- 6 When the connection has been verified, the "**Success! Your device is connected to the Internet. If you have any problems using online services, please contact your Internet service provider.**" message appears.

Manual Network Setup (Wireless)

Offices may use static IP addresses.

If this is the case, ask the network administrator for the IP address, subnet mask, gateway and DNS server address. Enter these values manually.

Getting the Network Connection Values

To view the Network connection values on most Windows computers, follow these steps.

- 1 Right click the Network icon on the bottom right of the screen.
- 2 In the pop-up menu that appears, click Status.
- 3 On the dialog that appears, click the **Support** tab.
- 4 On the **Support** Tab, click the **Details** button. The Network connection values are displayed.

How to set up manually

- 1 Set **Network Type** to **Wireless** from the **Open Network Settings** page.
- 2 The **Network** function searches for available wireless networks. When done, it displays a list of the available networks.
- 3 In the list of networks, press the ▲ or ▼ button to select a network, and then press the ⏎ button twice.
 - ✎ If the desired wireless router does not appear, select **Refresh** to search again.
 - ✎ If the router cannot be found after retrying, select the **Stop** button. The **Add Network** button appears.
- 4 If the **Enter the password for (AP Name)** screen appears, go to step 5. If you select a wireless router that does not have security, go to step 7.
- 5 If the router has security, enter the **Enter the password for (AP Name)**. (Security key or PIN).
- 6 When done, use the right arrow button to move the cursor to **Done**, and then press ⏎. The network connection screen appears and the verification process starts.
- 7 Select **Cancel** while network connections are being attempted. This will stop the connection.
- 8 Select **IP Settings** on network connection screen. The **IP Settings** screen appears.
- 9 Select the field at the top, press ⏎, and then set **IP setting** to **Enter manually**. Repeat the entry process for each field in the **IP Address**.
 - ✎ Setting **IP setting** to **Enter manually** automatically changes **DNS setting** to **Enter manually**.
- 10 When done, select **OK** at the bottom of the page, and then press ⏎. The network test screen appears and the verification process starts.
- 11 When the connection has been verified, the **“Success! Your device is connected to the Internet. If you have any problems using online services, please contact your Internet service provider.”** message appears.

Use WPS

How to set up using Use WPS

If your router has a **Use WPS** button, follow these steps.

- 1 Set **Network Type** to **Wireless** from the **Open Network Settings** page.
- 2 Select **Use WPS**, press .
- 3 Press the WPS or PBC button on your wireless router within the next two minutes. Your product automatically acquires all the network setting values it needs and connects to your network.
 - If you want to use the WPS PIN, select **WPS PIN**.
Go to your wireless router's Settings, enter your PIN, and then select **OK**.
- 4 The network connection screen appears, and network setup is done.

IPv6

 MENU → **Network** → **IPv6** → 

Enable or disable IPv6.

- **Off** (●) / **On** (●)

IPv6 Status

 MENU → **Network** → **IPv6 Status** → 

Check the status of your IPv6 Internet connection.

Server Network Settings

☰ MENU → Network → Server Network Settings → ↗

Connect to server

Connect to MagicInfo server.

- **Server Address / TLS / Port**

- ✎ If you do use the **TLS** option, the server is configured to use https and data transfer is encrypted. (Port number: 7002)
- ✎ If you don't use the **TLS** option, enter the server IP address and port number. Use 7001 as the port number. (If you are unable to connect to the server using port number 7001, check with your server administrator to find the correct port number and then change the port number.)
- ✎ Enter the server IP address and port number. Use 7001 as the port number. (If unable to connect to the server using port number 7001, check with your server administrator to find the correct port number and then change the port number.)
- ✎ For the MagicInfo Server user guide, visit the following website: <http://displaysolutions.samsung.com> → Support → Resources → MagicInfo Web Manual.

MagicInfo Mode

Select the appropriate **MagicInfo Mode** depending on the environment where you are using the product.

- **Lite / Premium**

Server Access

Allow or deny access to MagicInfo server.

- **Allow / Deny**

FTP Mode

Specify the FTP operating mode.

- **Active / Passive**

Proxy server

Set up your proxy server connection and related functions.

Off / On

- **Address / Port / ID / Password**
- ✎ **Address / Port / ID** and **Password** are enabled only when **Proxy server** is set to **On**.

Device Name

☰ MENU → Network → Device Name → ↗

Select or enter a device name.

This name can be shown on network device over the network.

- **[Signage] Display1 ~ 6 / User Input**

Chapter 09

System

Accessibility

☰ MENU → System → Accessibility → ☒

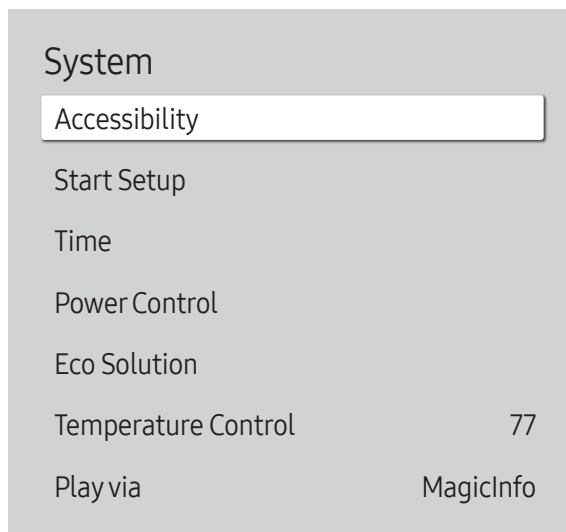

 The displayed image may differ depending on the model.

High Contrast

Set the background and font to high-contrast colours in Menu. Menu transparencies become opaque when the option is selected.

- Off (●) / On (●)

Enlarge

Enlarge the size of the Menu area.

- Off (●) / On (●)

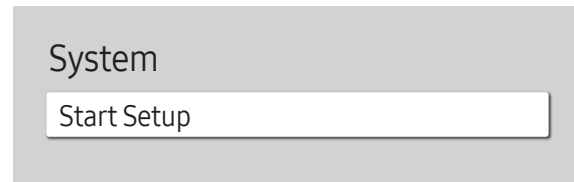

Start Setup

☰ MENU → System → Start Setup → 



 The displayed image may differ depending on the model.

Go through the initial setup steps like you did the first time you used this product.

-  Enter your 4 digit PIN number. The default PIN number is "0-0-0-0".
If you want to change the PIN number, use the **Change PIN** function.
-  Change the PIN to keep your device secure.

Time

☰ MENU → System → Time → ⏪

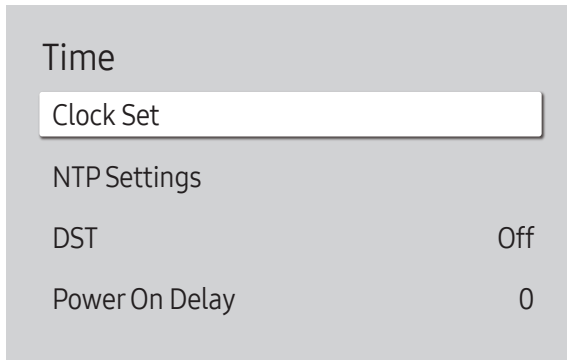

 The displayed image may differ depending on the model.

You can configure **Clock Set** or **DST**. Configure various time-related settings.

Clock Set

Select **Clock Set**. Select **Date** or **Time**, and then press ⏪.

Use the number buttons to enter numbers or press the up and down arrow buttons. Use the left and right arrow buttons to move from one entry field to the next. Press ⏪ when done.

 You can set the **Date** and **Time** directly by pressing the number buttons on the remote control.

NTP Settings

Set up the server URL and time zone to use the network time.

DST

Switches the DST (Daylight Saving Time) function on or off.

Off / On

- **Start Date**: Set the start date of Daylight Saving Time.
- **End Date**: Set the end date of Daylight Saving Time.
- **Time Offset**: Select the correct time offset for your timezone.

 **Start Date**, **End Date** and **Time Offset** are enabled only when **DST** is set to **On**.

Power On Delay

When connecting multiple products, adjust the power-on time for each product to prevent power overload (within the range 0–50 seconds).

Power Control

☰ MENU → System → Power Control → ↩

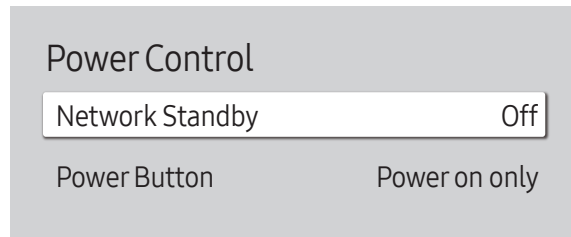

 The displayed image may differ depending on the model.

Eco Solution

☰ MENU → System → Eco Solution → ↩

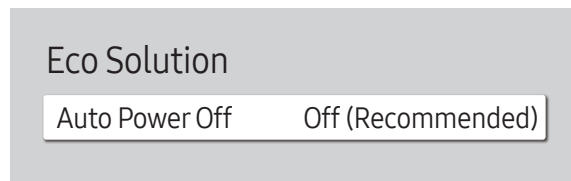

 The displayed image may differ depending on the model.



Network Standby

This feature keeps the network power on when the product turns off.

- Off / On

Power Button

The power button on the remote control  can be set to turn on the power or turn on or off the power.

- **Power on only:** Set the power button on the remote control  only to turn on the power.
- **Power on and off:** Set the power button on the remote control  to turn on or off the power.

Auto Power Off

Choose how long the display will wait before turning off after no user interaction is detected.

- Off (Recommended) / 4 hours / 6 hours / 8 hours

Temperature Control

☰ MENU → System → Temperature Control → ↻



 The displayed image may differ depending on the model.

This function detects the internal temperature of the product. You can specify the temperature range that is acceptable.

The default temperature is set to 77 °C.

The recommended operating temperature for this product is 75 to 80 °C (based on an ambient temperature of 40 °C).

 The screen will become darker if the current temperature exceeds the specified temperature limit. If the temperature continues to rise, the product will power off to prevent overheating.

Play via

☰ MENU → System → Play via → ↻



 The displayed image may differ depending on the model.

Select the appropriate **Play via** mode depending on the environment where you are using the product.

The home screen may be different depending on the setting.

- **MagicInfo / URL Launcher**

Change PIN

☰ MENU → System → Change PIN → 

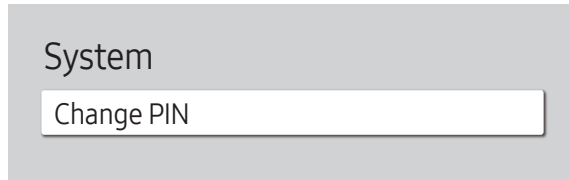

 The displayed image may differ depending on the model.

Change your 4-digit Personal Identification Number (PIN).

Choose any 4 digits for your PIN and enter it in **Enter a new PIN..** Reenter the same 4 digits in **Enter the PIN again..**

The product has memorised your new PIN.

 The default PIN number is "0-0-0-0".

 Change the PIN to keep your device secure.

Security

☰ MENU → System → Security → 

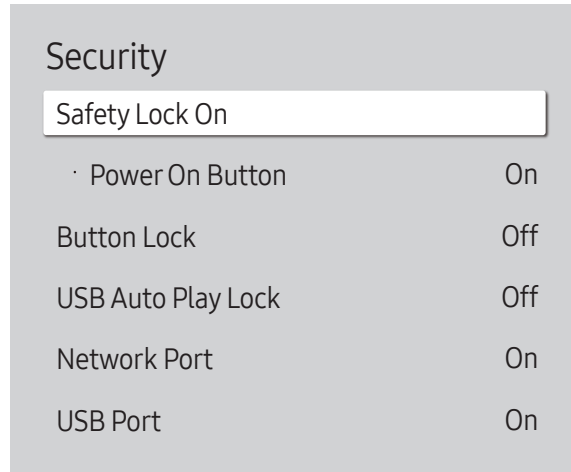

 The displayed image may differ depending on the model.

Safety Lock On

 Enter your 4 digit PIN number. The default PIN number is "0-0-0-0".
If you want to change the PIN number, use the **Change PIN** function.

 Change the PIN to keep your device secure.

Turn **Safety Lock On** on or off. **Safety Lock On** restricts the actions that can be carried out by the remote control. The correct PIN must be entered to turn **Safety Lock On** off.

Power On Button

Turn on this feature to enable the remote control's Power button to turn on the product while **Safety Lock On** is enabled.

- **Off / On**

Button Lock

This menu can be used to lock the buttons on the product.

Only the remote control can control the product if **Button Lock** is set to **On**.

- **Off / On**

Security

Safety Lock On

· Power On Button On

Button Lock Off

USB Auto Play Lock Off



Network Port On

USB Port On

 The displayed image may differ depending on the model.

USB Auto Play Lock

Select whether to automatically play **MagicInfo** content saved on a connected USB device.

 Your content should be a **Published Content**  that is authored by using **MagicInfo Premium** application and published to the USB device you are using. The **MagicInfo Premium** application programme is available on the website. (<http://displaysolutions.samsung.com>)

 When published to a USB device, your **Published Content**  is saved to **Contents** and **Schedules** folders in the root folder of the connected USB device.

- **Off**
Play **MagicInfo** content saved on the USB device automatically.
- **On**
Do not play **MagicInfo** content saved on the USB device automatically.

 Connecting a USB device containing **MagicInfo** content displays "**USB Auto Play Lock : On**" for five seconds.

Network Port

Block external network access. You can register networks on the server to allow access.

- **Off / On**

USB Port

Block connection to external USB ports.

- **Off / On**

General

☰ MENU → System → General → ↩

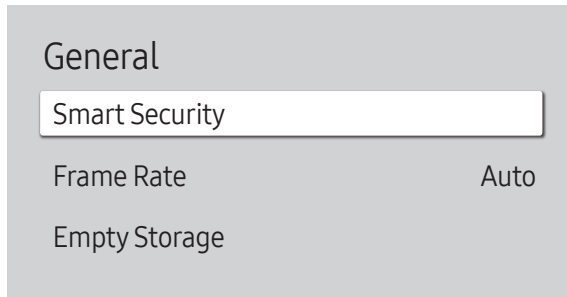

 The displayed image may differ depending on the model.

Smart Security

The security provided to protect your display device and connected storage devices against viruses includes.

Scan

Inspect your display device and connected storage devices to check for viruses.

Isolated List

This is the list of items that have been Isolated for containing viruses.

Frame Rate

Set the frame rate of the video signal. Select **Auto** to automatically match the original frame rate of the content or specify a fixed frame rate.

Empty Storage

Delete files to make space for new content. Recently played files will not be deleted.

Reset System

Reset all system settings to default.

☰ MENU → System → Reset System → ↩

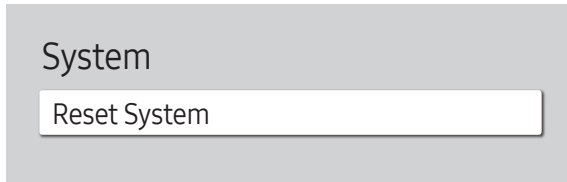

 The displayed image may differ depending on the model.

Chapter 10

Support

Software Update

☰ MENU → Support → Software Update → 

The **Software Update** menu lets you upgrade your product software to the latest version.

 Be careful not to turn off the power until the upgrade is complete. The product will turn off and on automatically after completing the software upgrade.

Update Now

Update the software to the latest version.

 **Current version:** This is the software version already installed in the product.

Contact Samsung

☰ MENU → Support → Contact Samsung → 

You can view the address of the Samsung website, the call centre phone number, your product's model number, software version, Open Source Licence and other information.

 Go to **Contact Samsung** and find the product **Model Code** and **Software Version**.

Terms & Conditions

☰ MENU → Support → Terms & Conditions → 

View and set the privacy policy for MagicInfo and other services.

 Make sure that the product is connected to the network.

Reset All

☰ MENU → Support → Reset All → 

This option returns all the current settings for a display to the default factory settings.

Chapter 11

Troubleshooting Guide

Requirements Before Contacting Samsung Customer Service Centre

 Before calling Samsung Customer Service Centre, test your product as follows. If the problem persists, contact Samsung Customer Service Centre.

Testing the Product

Check if your product is operating normally by using the product test function.

If the screen remains blank while the power indicator blinks even when the product is correctly connected to a PC, perform product testing.

- 1 Power off both the PC and product.
- 2 Disconnect all the cables from the product.
- 3 Power on the product.
- 4 If **No Signal** is displayed, the product is operating normally.

If the screen remains blank, check the PC system, video controller and cable.

Checking the Resolution and Frequency

For modes that exceed the supported resolutions, the message "**Not Optimum Mode**" appears briefly.

Set the PC resolution by referring to [Preset Timing Modes](#).

Check the followings.

Screen issue	
The power indicator is off. The screen will not switch on.	Make sure that the power cord is connected.
The images on the screen look distorted.	Check the cable connection to the product.
The screen is not clear. The screen is blurry.	Set the resolution and frequency to the recommended level.
The screen appears unstable and shaky.	Check that the resolution and frequency of the PC and graphics card are set within a range compatible with the product. Then, change the screen settings if required by referring to 'Preset Timing Modes'.
There are shadows or ghost images left on the screen.	
The screen display does not look normal.	Encoded video content may cause the display to appear corrupted in scenes featuring fast moving objects such as in a sports event or action video.
	Low signal level or low picture quality may cause the display to appear corrupted. This does not mean the product is defective.
	A cell phone within a distance of one-meter radius may cause static on analogue and digital products.
I see red, green, and blue.	Check the cable connections.
	This issue may happen when the panel of the product is defective. Contact a Samsung Service Centre to resolve the issue.
The display looks unstable and then freezes.	The screen may freeze when a resolution other than the recommended resolution is used or if the signal is not stable. To resolve the issue, change the PC resolution to the recommended resolution.

Screen issue

The screen cannot be displayed in full screen.	A scaled SD (4:3) content file can cause black bars on both sides of an HD channel screen.
	A video with an aspect ratio different from the product can cause a black bar to appear at the top and bottom of the screen.
	Change the screen size setting to full screen on the product or source device.

Sound issue

There is no sound.	Check the connection of the audio cable or adjust the volume.
	Check the volume.
The volume is too low.	Adjust the volume.
	If the volume is still low after turning it up to the maximum level, adjust the volume on your PC sound card or software programme.
Video is available but there is no sound.	If a source device is used <ul style="list-style-type: none">• Make sure the audio cable is properly connected to the audio input port on the product.• Check the audio output settings for the source device. (For example, if your monitor is connected to HDMI, you may need to change the audio option of your video output device to HDMI.)
	Reconnect the power cable to the device and then reboot the device.
There is static coming from the speakers.	Check the cable connection. Make sure a video cable is not connected to an audio input port.
	Check the signal strength after connecting a cable.
	Low signal level can cause corrupted sound.

Remote control issue

The remote control does not work.	Make sure that the batteries are correctly in place (+/-).
	Check if the batteries are flat.
	Check for power failure.
	Make sure that the power cord is connected.
	Check for any special lighting or neon signs switched on in the vicinity.

Other issue

The product smells like plastic.	The plastic smell is normal and disappears over time.
Audio or video cuts out intermittently.	Check the cable connection and connect it again if required.
	Use a standard cable.
Small particles are found on the edges of the product.	The particles are part of the product design. The product is not defective.

Chapter 12

Specifications

General

Model Name		SBB-SSN / SBB-SSNU
Power Supply		AC100-240V~ 50/60Hz Based on the AC voltage of the adapter. For the DC voltage of the product, refer to the product label.
Environmental considerations	Operating	Temperature: 0 °C – 40 °C (32 °F – 104 °F) * For installing the enclosure, keep the internal temperature at 40 °C or below. Humidity: 10% – 80%, non-condensing
	Storage	Temperature: -20 °C – 45 °C (-4 °F – 113 °F) Humidity: 5% – 95%, non-condensing * Applicable before the product package is unpacked.
Supported models		OME, OHE, EDE, UDE, UHF, UHF-E, UMH-E, PMF, PMH, PHF, PHF-P, DBE, DCE, DCE-H, DCE-M, DHE, DME, QMF, QBH, QHH, QMH, VHT-E, VMT-U, VMT-E, VHR-R

 The message below will appear when the product is connected to an unsupported display and cannot work properly.

The Signage Player Box is not supported by this display. Turn off the display and remove the Signage Player Box.

- **Plug-and-Play**
This monitor can be installed and used with any Plug-and-Play compatible systems. Two-way data exchange between the monitor and PC system optimises the monitor settings. Monitor installation takes place automatically. However, you can customise the installation settings if desired.
- Due to the nature of the manufacturing of this product, approximately 1 pixel per million (1ppm) may appear brighter or darker on the panel. This does not affect product performance.
- This is a class A product. In a domestic environment this product may cause radio interference in which case the user may be required to take adequate measures.
- For detailed device specifications, visit the Samsung Electronics website.

Preset Timing Modes

 This product can be set to only one resolution for each screen size to obtain the optimum picture quality due to the nature of the panel. Using a resolution other than the specified resolution may degrade the picture quality. To avoid this, it is recommended that you select the optimum resolution specified for your product.

Resolution	Optimum resolution	3840 x 2160 @ 60 Hz
	Maximum resolution	

The screen will automatically be adjusted if a signal that belongs to the following standard signal modes is transmitted from your PC. If the signal transmitted from the PC does not belong to the standard signal modes, the screen may be blank with the power indicator on. In such a case, change the settings according to the following table by referring to the graphics card user manual.

Resolution	Horizontal Frequency (kHz)	Vertical Frequency (Hz)	Pixel Clock (MHz)	Sync Polarity (H/V)
IBM, 720 x 400	31.469	70.087	28.322	-/+
MAC, 640 x 480	35.000	66.667	30.240	-/-
MAC, 832 x 624	49.726	74.551	57.284	-/-
MAC, 1152 x 870	68.681	75.062	100.000	-/-
VESA, 640 x 480	31.469	59.940	25.175	-/-
VESA, 640 x 480	37.861	72.809	31.500	-/-
VESA, 640 x 480	37.500	75.000	31.500	-/-
VESA, 800 x 600	35.156	56.250	36.000	+/+
VESA, 800 x 600	37.879	60.317	40.000	+/+
VESA, 800 x 600	48.077	72.188	50.000	+/+

Resolution	Horizontal Frequency (kHz)	Vertical Frequency (Hz)	Pixel Clock (MHz)	Sync Polarity (H/V)
VESA, 800 x 600	46.875	75.000	49.500	+/+
VESA, 1024 x 768	48.363	60.004	65.000	-/-
VESA, 1024 x 768	56.476	70.069	75.000	-/-
VESA, 1024 x 768	60.023	75.029	78.750	+/+
VESA, 1152 x 864	67.500	75.000	108.000	+/+
VESA, 1280 x 720	45.000	60.000	74.250	+/+
VESA, 1280 x 800	49.702	59.810	83.500	-/+
VESA, 1280 x 1024	63.981	60.020	108.000	+/+
VESA, 1280 x 1024	79.976	75.025	135.000	+/+
VESA, 1366 x 768	47.712	59.790	85.500	+/+
VESA, 1440 x 900	55.935	59.887	106.500	-/+
VESA, 1600 x 900	60.000	60.000	108.000	+/+
VESA, 1680 x 1050	65.290	59.954	146.250	-/+
VESA, 1920 x 1080	67.500	60.000	148.500	+/+
VESA, 3840 x 2160	133.313	59.997	533.250	+/-

Chapter 13

Appendix

Responsibility for the Pay Service (Cost to Customers)

 When the service is requested, in spite of in warranty, we may charge you for a visit from a service technician in the following cases.

Not a product defect

Cleaning of the product, Adjustment, Explanation, Re-installation and etc.

- If a service technician is requested to give instructions on how to use product or simply adjusts options without disassembling product.
- If a defect is caused by external environmental factors (Internet, Antenna, Wired Signal, etc.)
- If a product is reinstalled or devices are connected additionally after installing the purchased product for the first time.
- If a product is reinstalled to move to a different spot or to move to a different house.
- If the customer requests instructions on how to use another company's product.
- If customer requests instructions on how to use the network or another company's programme.
- If customer requests software installation and setup for the product.
- If a service technician removes/cleans dusts or foreign materials inside of the product.
- If customer requests an installation additionally after purchasing a product through home-shopping or online.

A Product damage caused by customer's fault

Product damage caused by customer's mishandling or wrong repair

If a product damage is caused by;

- External impact or drop.
- Use of supplies or separately sold product unspecified by Samsung.
- Repair from a person besides an engineer of outsourcing service company or partner of Samsung Electronics Co., Ltd.
- Remodeling or repairing the product by customer.
- Using it with incorrect voltage or non-authorized electrical connections.
- Not following the "cautions" in User Manual.

Others

- If product fails by natural disaster. (lightning, fire, earthquake, flood damage, etc)
 - If consumable components are all used up. (Battery, Toner, Fluorescent lights, Head, Vibrator, Lamp, Filter, Ribbon, etc.)
-  If customer requests a service in case the product has no defect, service fee may be charged. So please read User Manual first.

Licence



Manufactured under license from Dolby Laboratories.

Dolby, Dolby Audio, Pro Logic, and the double-D symbol are trademarks of Dolby Laboratories.



The terms HDMI and HDMI High-Definition Multimedia Interface, and the HDMI Logo are trademarks or registered trademarks of HDMI Licensing Administrator, Inc. in the United States and other countries.

Open Source Licence Notice

In the case of using open source software, Open Source Licences are available on the product menu. Open Source Licence Notice is written only English.

For information on the Open Source Licence Notice, contact the Samsung Customer Centre or send email to oss.request@samsung.com.



THIS PRODUCT IS SOLD WITH A LIMITED LICENCE AND IS AUTHORISED TO BE USED ONLY IN CONNECTION WITH HEVC CONTENT THAT MEETS EACH OF THE THREE FOLLOWING QUALIFICATIONS: (1) HEVC CONTENT ONLY FOR PERSONAL USE; (2) HEVC CONTENT THAT IS NOT OFFERED FOR SALE; AND (3) HEVC CONTENT THAT IS CREATED BY THE OWNER OF THE PRODUCT.

THIS PRODUCT MAY NOT BE USED IN CONNECTION WITH HEVC ENCODED CONTENT CREATED BY A THIRD PARTY, WHICH THE USER HAS ORDERED OR PURCHASED FROM A THIRD PARTY, UNLESS THE USER IS SEPARATELY GRANTED RIGHTS TO USE THE PRODUCT WITH SUCH CONTENT BY A LICENSED SELLER OF THE CONTENT.

YOUR USE OF THIS PRODUCT IN CONNECTION WITH HEVC ENCODED CONTENT IS DEEMED ACCEPTANCE OF THE LIMITED AUTHORITY TO USE AS NOTED ABOVE.
