

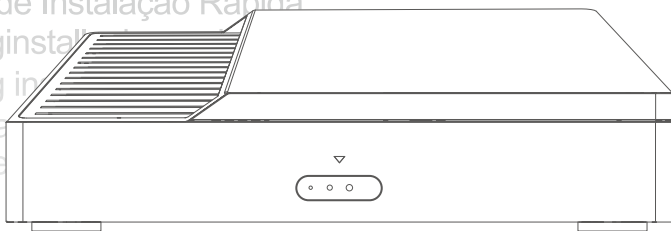

KoiBox-100W

Quick Installation Guide

快速安裝手冊 빠른 설치 설명서 Guía de Instalación Rápida
クイックインストールガイド Hızlı Kurulum Kılavuzu
คู่มือการติดตั้งแบบเร็ว Gyors telepítési útmutató
Instrukcja szybkiej instalacji Průvodce rychlou in
Kurzinstructionsanleitung 快速安裝指南
Guida di installazione rapida Pika-asennusopas
Краткое руководство по установке
Snabbinstallationsguide
Guia de Instalação Rápida
Hurtiginstallationsguide
Hurtig in
Pika-a
Snelle



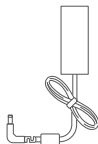
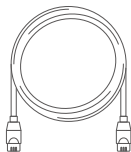
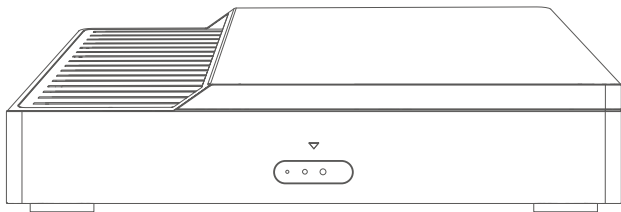



HDD

<http://www.qnap.com/compatibility>

- All the drive data will be cleared upon HDD initialization ----- en
- Alle Laufwerksdaten werden bei der HDD-Initialisierung gelöscht ----- de
- Toutes les données présentes sur les disques seront effacées lors de l'initialisation du HDD ----- fr
- Tutti dati dell'unità saranno cancellati con l'inizializzazione del disco rigido ----- it
- Todos los datos del disco se borrarán después de la inicialización del HDD ----- es
- Als de HDD wordt geïnitieerd, dan worden alle gegevens erop gewist ----- nl
- Alla data på disken rensas när HDD initieras ----- sv
- Kaikki aseman tiedot tyhjennetään kiintolevyn alustuksen yhteydessä ----- fi
- Alle data på disken ryddes, når harddisken initialiseres ----- da
- Alle data blir slettet når HDD initialiseres ----- no
- Todos os dados do disco serão apagados na inicialização do HDD ----- pt
- После инициализации жесткого диска все данные на нем будут очищены ----- ru
- 硬碟初始化時・所有資料皆會被清除 ----- zh
- HDD 初始化時・所有磁盤上的數據都將被清除 ----- cn
- HDD を初期化すると、すべてのドライブデータが消去されます ----- ja
- HDD 초기화시 모든 드라이브 데이터가 삭제됩니다 ----- ko
- ข้อมูลทั้งหมดในไดรฟ์จะถูกล้าง เมื่อเตรียมใช้งาน HDD ----- th
- HDD başlatıldıktan sonra tüm sürücü verileri temizlenecektir ----- tr
- A HDD inicializálása a meghajtó összes adatát törli ----- hu
- Všetchna data disku budou při inicializaci jednotky pevného disku odstraněna ----- cs
- Po zainicjowaniu dysku twardego wszystkie znajdujące się na nim dane zostaną usunięte ----- pl
- ئەبھت دەنە صەرقلأ کر حرم HDD (ەببلا صەرقلأ کر حرم) ----- ar

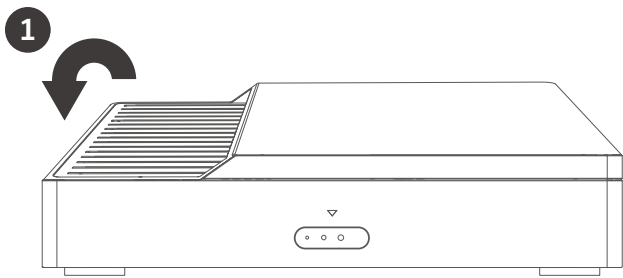

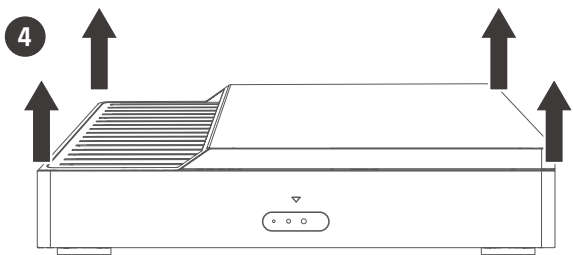
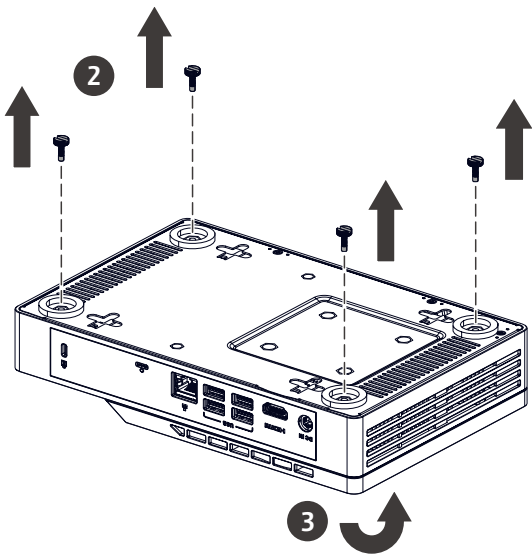

03

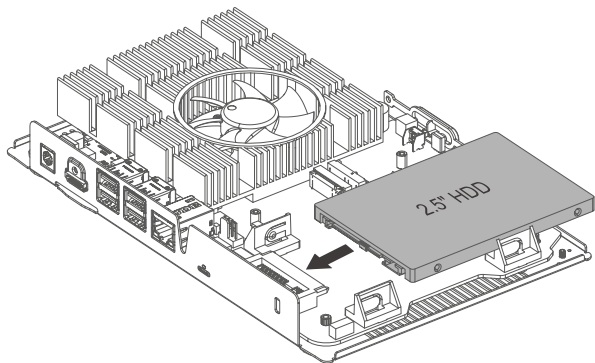

04

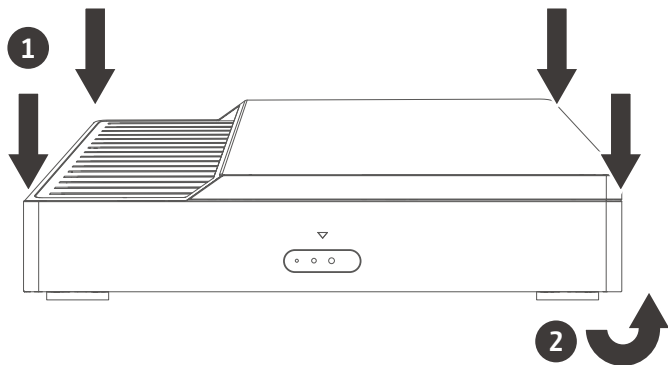

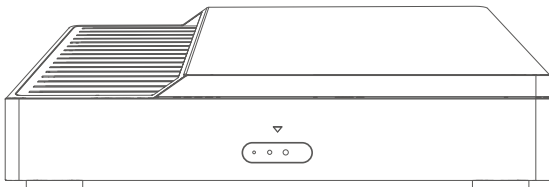
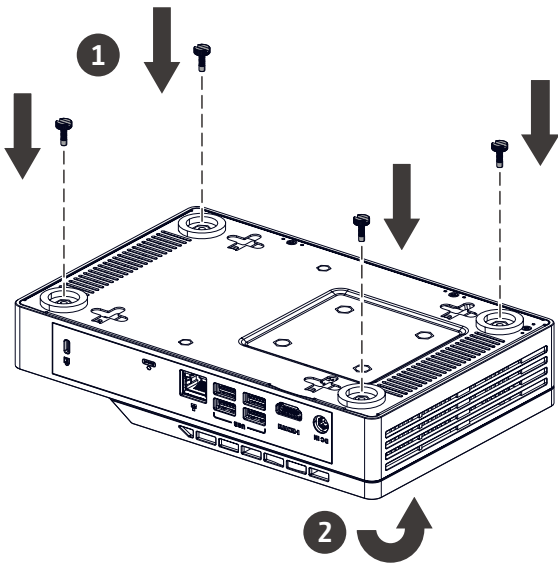

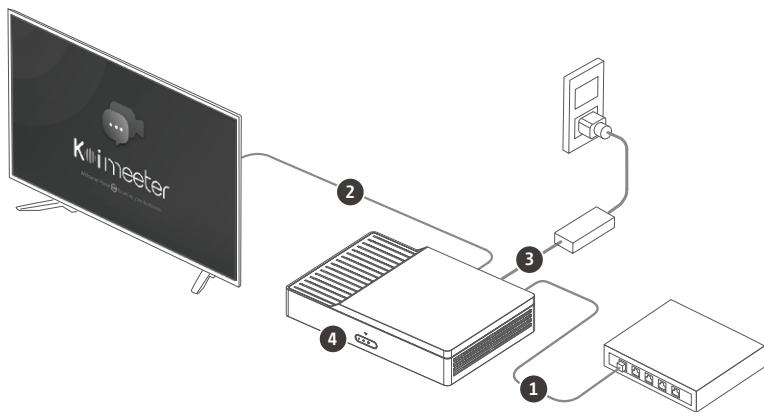
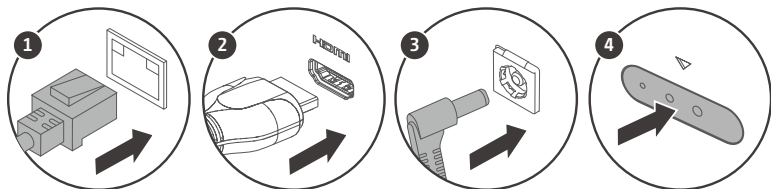

EN

Follow the setup guide shown on the HDMI display with the remote control.

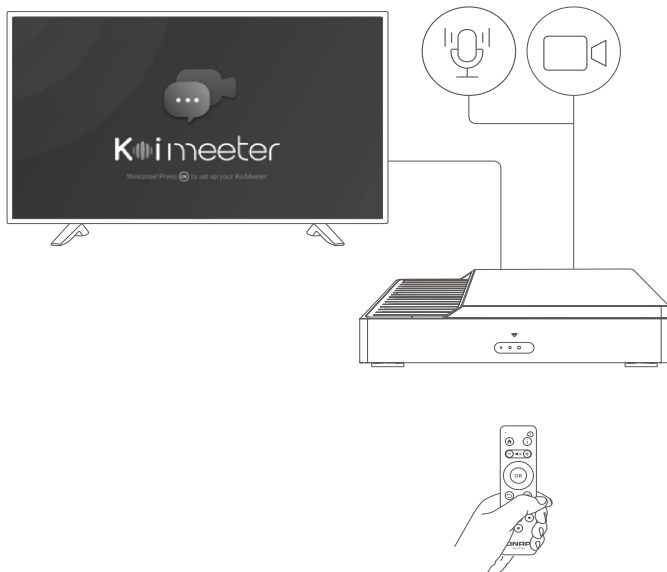

Connect the USB camera and microphone.

DE

Folgen Sie der auf dem HDMI-Display angezeigten Einrichtungsanleitung mit der Fernbedienung.



Schließen Sie die USB-Kamera und das Mikrofon an.

FR

Suivez le guide de configuration affiché sur l'écran HDMI avec la télécommande.

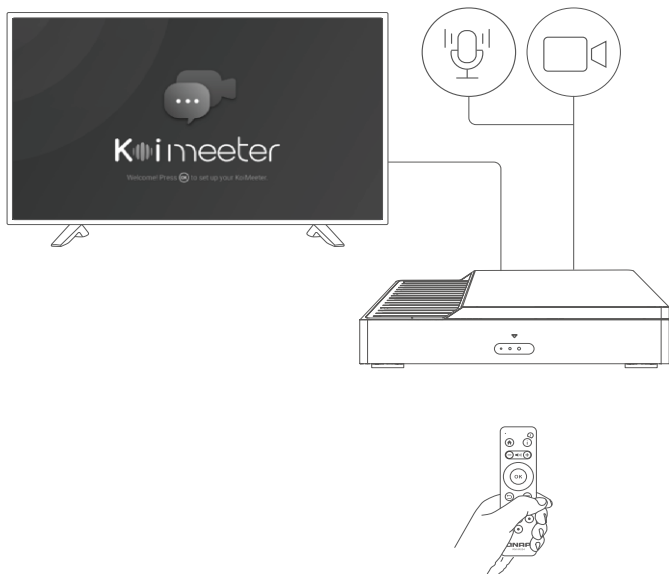

Connectez la caméra USB et le microphone.

IT

Seguire la guida di configurazione riportata sul display HDMI con il controllo remoto.



Connettere la fotocamera e il microfono USB.

ES

Siga la guía de configuración mostrada en la pantalla de HDMI con el mando a distancia.

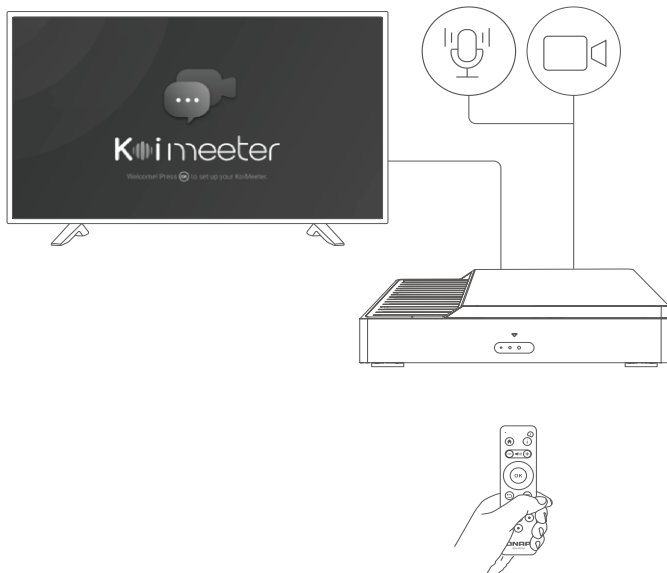

Conecte la cámara y el micrófono USB.



Volg de installatiewizard op het HDMI-display met behulp van de afstandsbediening.

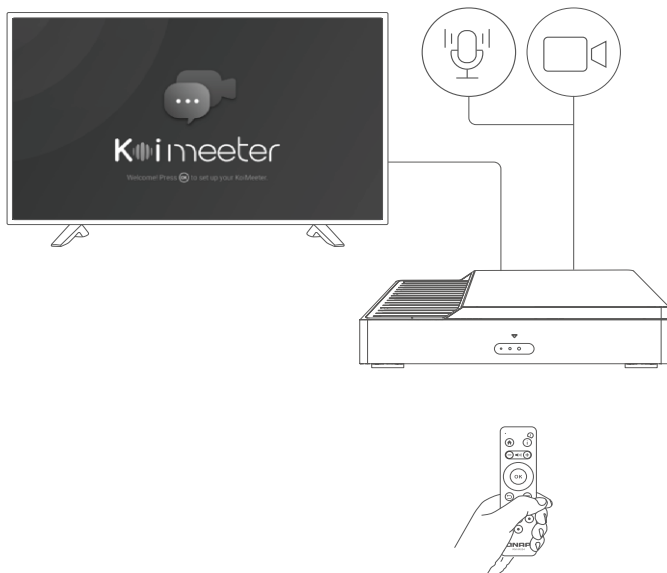

Sluit de USB-camera en -microfoon aan.

SV

Följ inställningsguiden, som visas på HDMI-skärmen, med fjärrkontrollen.

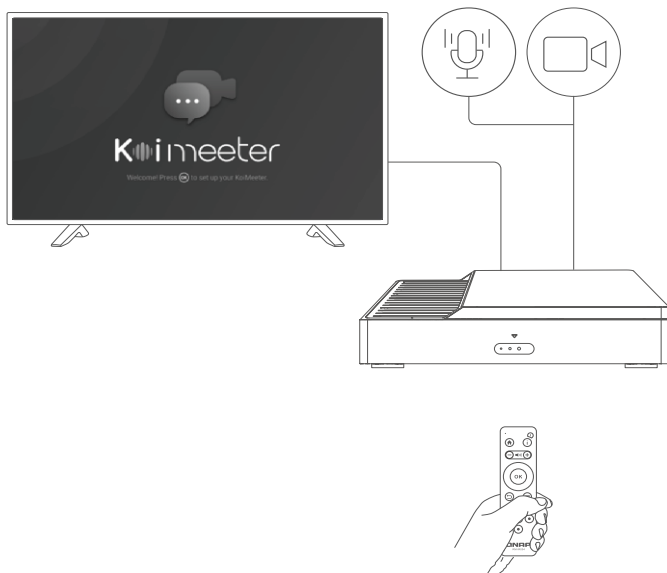

Anslut kameran och mikrofonen med USB-gränssnitt.

FI

Noudata HDMI-näytössä näkyvää asennusopasta kauko-ohjaimen avulla.



Liitä USB-kamera ja mikrofoni.

DA

Følg opsætningsvejledningen, der vises på HDMI-skærmen med fjernbetjeningen.

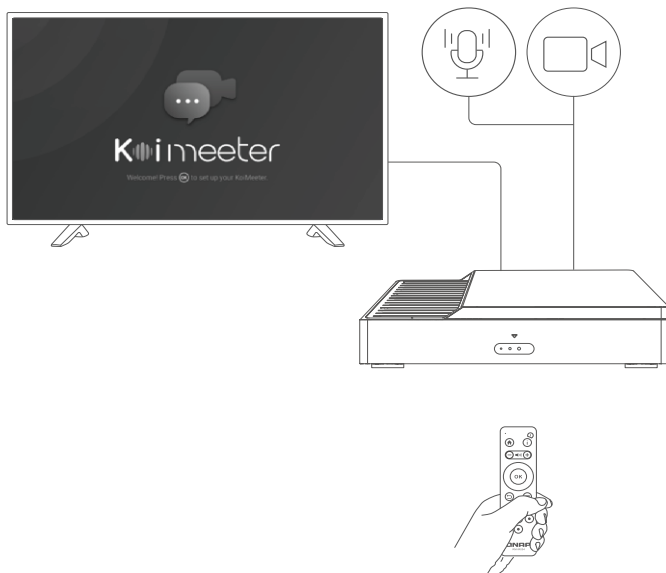

Tilslut USB-kameraet og mikrofonen.

NO

Følg konfigurasjonsveiledningen på HDMI-skjermen med fjernstyingsenheten.

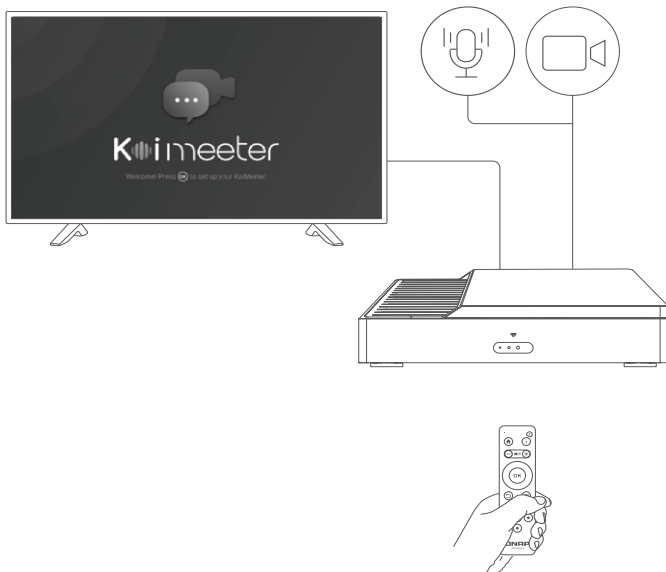

Koble til USB-kameraet og mikrofonen.

PT

Siga o guia de configuração mostrado no ecrã HDMI com o controlo remoto.

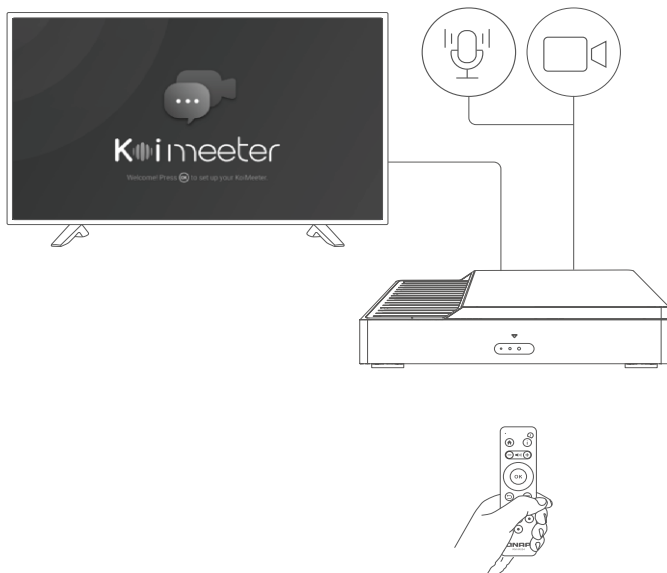

Ligue a câmara e o microfone USB.

RU

Следуйте указаниям руководства по настройке на экране HDMI с помощью пульта ДУ.



Подключите USB-камеру и микрофон.

ZH

請利用遙控器，按照 HDMI 顯示器上的設定指南操作。

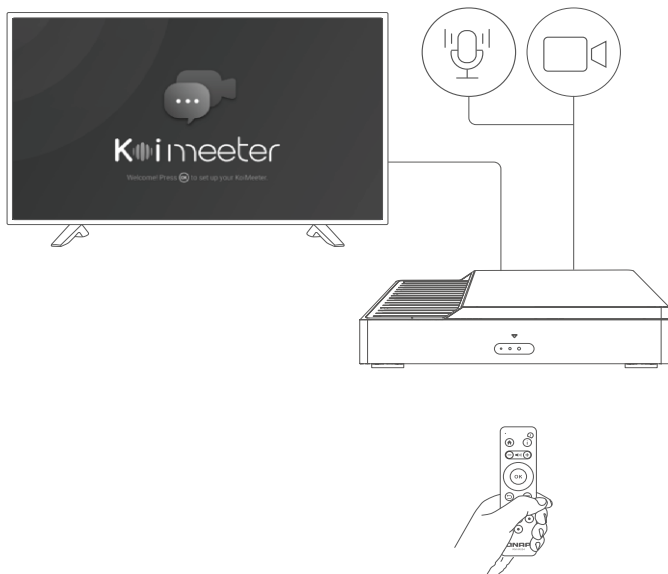

請接上 USB 攝影機與麥克風。

CN

请使用遥控器按照 HDMI 显示器上显示的安装指南操作。

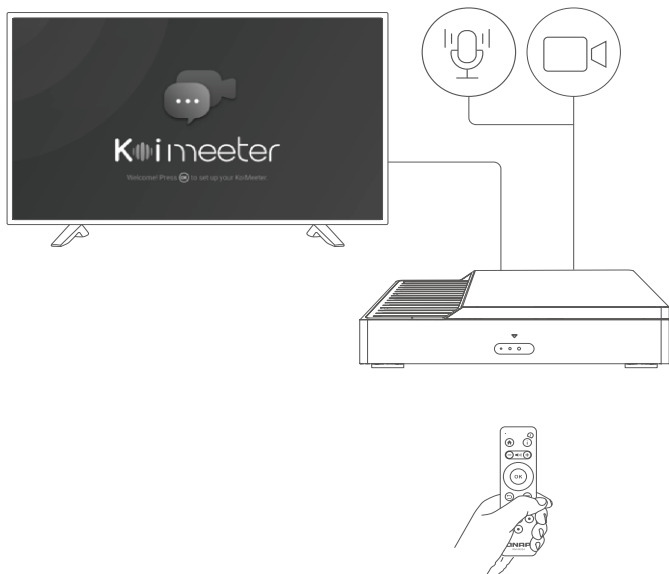

连接 USB 摄像头和麦克风。

JA

リモートコントロールを使用し、HDMI ディスプレイに表示されるセットアップガイドを参照してください。

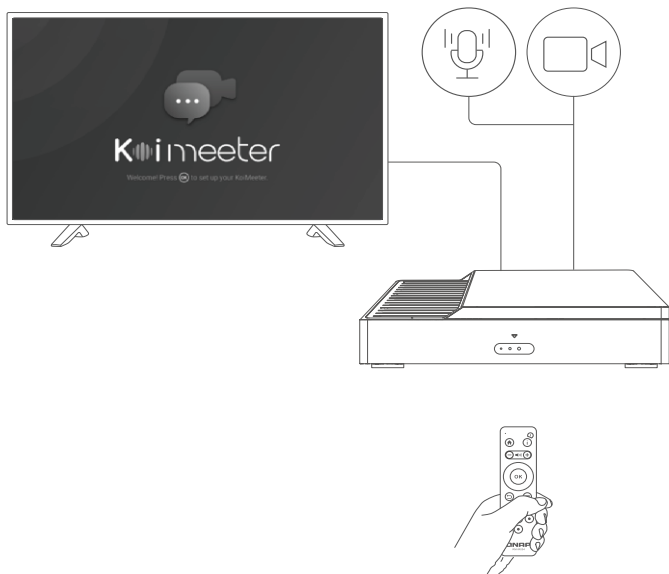

USB カメラとマイクロフォンを接続してください。

KO

원격 제어를 통해 HDMI 디스플레이에 표시된 설치 안내를 따르십시오 .

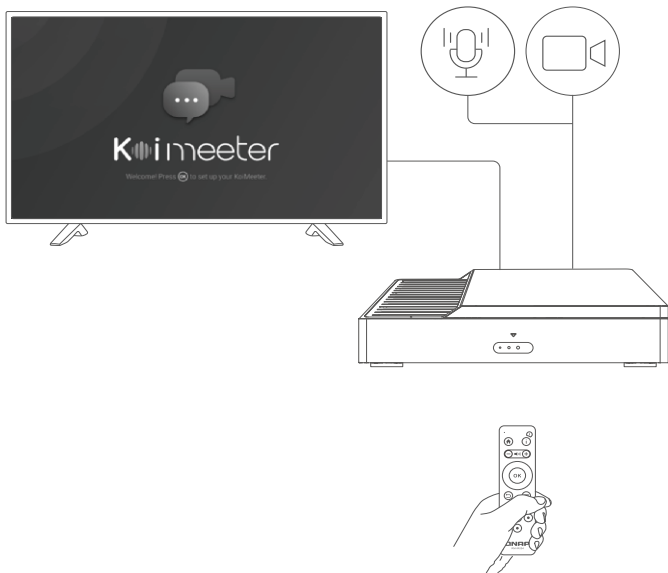

USB 카메라와 마이크를 연결합니다 .



กรุณาทำตามคำแนะนำในการเชื่อมต่อที่แสดงบนหน้าจอ HDMI โดยใช้โมทคอนโทรล



เชื่อมต่อกล่องและไมโครโฟน USB

TR

Uzaktan kumanda ile HDMI ekranından gösterilen kurulum kılavuzunu izleyin.



USB kamera ve mikrofonu bağlayın.

HU

Kövesse a távirányítóval a HDMI kijelzőn látható telepítési útmutatót.

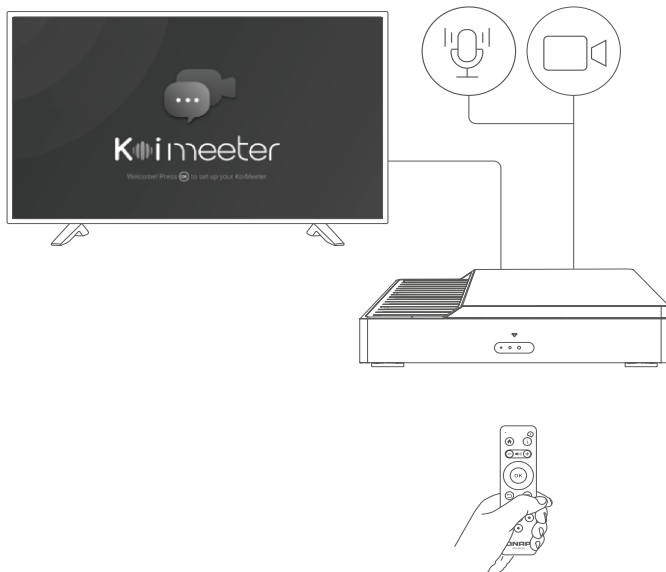

Csatlakoztassa az USB kamerát és a mikrofont.

CS

Postupujte podle průvodce nastavením na displeji HDMI s dálkovým ovládačem.

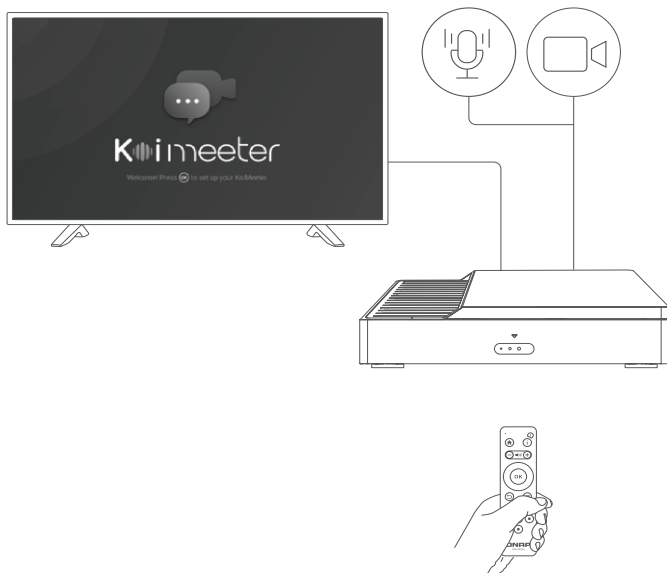

Připojte kameru a mikrofon USB.

PL

Wykonaj instrukcje konfiguracji widoczne na wyświetlaczu HDMI za pomocą pilota.



Podłącz kamerę i mikrofon USB.

دعب نع مكحت لادحوب HDMI ضرع ةشاش ىلع حضوم لادعإلا لىلد عب تا



نوفوركيم ل او USB اريماك لّو



Download Center
www.qnap.com/download

- Visit Download Center for our full guides and utilities. ----- en
- Unsere vollständigen Handbücher und Dienstprogramme finden Sie im Download Center. ----- de
- Visitez le Centre de téléchargement pour accéder à nos guides et utilitaires complets. ----- fr
- Per le guide e le utilità complete, visitare il Centro download. ----- it
- Visite el Centro de descargas para ver todas nuestras guías y utilidades. ----- es
- Bezoek het downloadcentrum voor onze uitgebreide gidsen en hulpprogramma's. ----- nl
- Besök Nedladdningscenter för våra fullständiga guider och verktyg. ----- sv
- Katso täydelliset oppaat ja apuohjelmat latauskeskuksestamme. ----- fi
- Besøg Downloadcenter for at se alle vores vejledninger og hjælpeværktøjer. ----- da
- Gå til Nedlastingscenter for fullstendige veiledninger og verktøy. ----- no
- Visite a Central de Download para acessar nossos guias e utilitários completos. ----- pt
- Чтобы ознакомиться с полным набором руководств и служебных программ, посетите Центр загрузки. ----- ru
- 請前往下載中心取得完整指南和應用工具。 ----- tw
- 有关完整指南和实用工具，请访问“下载中心”。 ----- cn
- 完全なガイドとユーティリティについては、ダウンロードセンターをご覧ください。 ----- ja
- 다운로드 센터에서 전체 지침 및 유틸리티를 확인하십시오. ----- ko
- กรุณาเข้าสู่ศูนย์การดาวน์โหลดเพื่อดูดาวน์โหลดคู่มือฉบับสมบูรณ์และโปรแกรมอรรถประโยชน์ต่างๆ ----- th
- Tam kilavuzumuz ve yardımcı hizmetlerimiz için İndirme Merkezi'ni ziyaret edin. ----- tr
- A teljes útmutatók és segédprogramok megtekintéséhez keresse fel a Letöltési központot. ----- hu
- Kompletního průvodce a nástroje najdete na webu Centrum stahování. ----- cs
- Odwiedź Centrum pobierania, aby uzyskać kompletne przewodniki i narzędzia. ----- pl
- المساعدة الكاملة للحصول على الأدلة والأدوات تفضل بزيارة مركز التنزيل ----- ar



This device complies with Part 15 of the FCC Rules. Operation is subject to the following two conditions:

1. This device may not cause harmful interference.
2. This device must accept any interference received, including interference that may cause undesired operation.

FCC Class B Notice:

This equipment has been tested and found to comply with the limits for a Class B digital device, pursuant to Part 15 of the FCC Rules. These limits are designed to provide reasonable protection against harmful interference in a residential installation. This equipment generates, uses, and can radiate radio frequency energy and, if not installed and used in accordance with the instructions, may cause harmful interference to radio communications. However, there is no guarantee that interference will not occur in a particular installation. If this equipment does cause harmful interference to radio or television reception, which can be determined by turning the equipment off and on, the user is encouraged to try to correct the interference by one or more of the following measures:

- Reorient or relocate the receiving antenna.
- Increase the separation between the equipment and receiver.
- Connect the equipment into an outlet on a circuit different from that to which the receiver is connected.
- Consult the dealer or an experienced radio/television technician for help.

Modifications:

Any modifications made to this device that are not approved by QNAP Systems, Inc. may void the authority granted to the user by the FCC to operate this equipment.



This device complies with CE compliance Class B.



According to the requirement of the WEEE legislation the following user information is provided to customers for all branded QNAP products subject to the WEEE directive.

This symbol on the product or on its packaging indicates that this product must not be disposed of with your other household waste. Instead, it is your responsibility to dispose of your waste equipment by handing it over to a designated collection point for the recycling of waste electrical and electronic equipment. The separate collection and recycling of your waste equipment at the time of disposal will help to conserve natural resources and ensure that it is recycled in a manner that protects human health and the environment. For more information about where you can drop off your waste equipment for recycling, please contact your local city office, your household waste disposal service or the shop where you purchased the product.



D33B77
RoHS

更多關於安全、法規・與環境法令遵循相關的資訊・請參閱以下網址 www.qnap.com/regulatory/・



※ 付属の電源コードは当該製品専用です・他の機器に使用しないでください・

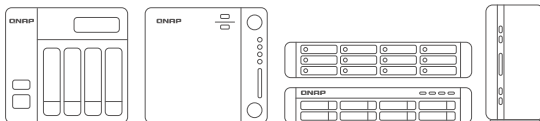

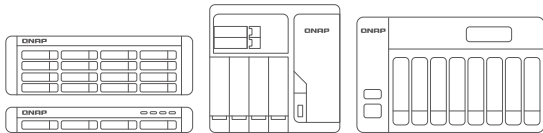

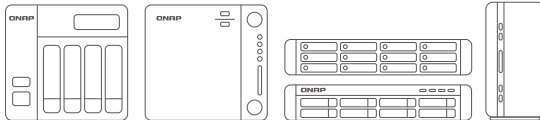



install.qnap.com



service.qnap.com



download.qnap.com

QNAP

Printed in Taiwan
P/N: 51000-024932-HF