



# Newland

SCANNING MADE SIMPLE



## FR80 Salmon stationary scanner user guide

# Disclaimer

© 2020 Fujian Newland Auto-ID Tech. Co., Ltd. All rights reserved.

Please read through the manual carefully before using the product and operate it according to the manual. It is advised that you should keep this manual for future reference.

Do not disassemble the device or remove the seal label from the device, doing so will void the product warranty provided by Fujian Newland Auto-ID Tech. Co., Ltd.

All pictures in this manual are for reference only and actual product may differ. Regarding to the product modification and update, Fujian Newland Auto-ID Tech. Co., Ltd. reserves the right to make changes to any software or hardware to improve reliability, function, or design at any time without notice. The information contained herein is subject to change without prior notice.

The products depicted in this manual may include software copyrighted by Fujian Newland Auto-ID Tech. Co., Ltd or third party. The user, corporation or individual, shall not duplicate, in whole or in part, distribute, modify, decompile, disassemble, decode, reverse engineer, rent, transfer or sublicense such software without prior written consent from the copyright holders.

This manual is copyrighted. No part of this publication may be reproduced, distributed or used in any form without written permission from Newland.

Fujian Newland Auto-ID Tech. Co., Ltd. reserves the right to make final interpretation of the statement above.

Fujian Newland Auto-ID Tech. Co., Ltd.

3F, Building A, No.1, Rujiang West Rd., Mawei, Fuzhou, Fujian, China 350015

<http://www.newlandaidc.com>

## Revision History

Version	Description	Date
V1.0.0	Initial release.	Sept. 16, 2020
V1.0.1	Updated the factory defaults table. Updated the VID/PID section.	October 14, 2020

# Table of Contents

<b>Revision History .....</b>	<b>- 3 -</b>
<b>Preface .....</b>	<b>1</b>
Introduction .....	1
Explanation of Icons .....	1
<b>Chapter 1 Getting Started .....</b>	<b>2</b>
Introduction .....	2
Application Scenarios .....	2
Symbologies .....	2
Features .....	2
FR80 Scanner .....	3
<b>Chapter 2 Installation .....</b>	<b>4</b>
Introduction .....	4
General Requirements .....	4
Prevention of Water .....	4
Dust and Dirt .....	4
Ambient Environment .....	4
Optical Elements .....	5
Mounting .....	6
Installation of Optional Base .....	8
Ambient Light .....	9
Eye Safety .....	9
<b>Chapter 3 Interfaces and Electrical Specifications .....</b>	<b>10</b>
Interface Pinouts .....	10
Adapter and DC Interface .....	10
Connect to the Host .....	13
Electrical Specifications .....	14
<b>Chapter 4 Operating Instructions .....</b>	<b>15</b>
Introduction .....	15
Barcode Scanning .....	15
Status Indicator .....	16
Keys .....	16
Maintenance .....	16
<b>Chapter 5 EasySet .....</b>	<b>17</b>

<b>Chapter 6 System Settings</b> .....	<b>18</b>
Introduction .....	18
Barcode Programming .....	18
Command Programming .....	18
EasySet Programming .....	18
Programming Barcode/ Programming Command/Function .....	19
Use of Programming Command .....	20
Command Syntax .....	20
Query Commands .....	20
Responses .....	21
Examples .....	21
Use of Programming Barcodes .....	22
Power On Beep .....	23
Good Read Beep .....	23
Good Read Beep Volume .....	24
Good Read Sound Effect .....	25
Scan Mode .....	26
Decode Session Timeout .....	27
Image Stabilization Timeout (Sense Mode) .....	28
Image Decoding Timeout .....	29
Surround GS1 Application Identifiers (AI's) with Parentheses .....	29
Scanning Preference .....	31
Decode Area .....	31
Image Flipping .....	31
Bad Read Message .....	32
Set Bad Read Message .....	32
Default Settings .....	33
Factory Defaults .....	33
Custom Defaults .....	33
Query Product Information .....	34
Query Product Name .....	35
Query Firmware Version .....	35
Query Decoder Version .....	36
Query Hardware Version .....	36
Query Product Serial Number .....	36
Query Manufacturing Date .....	37
Query OEM Serial Number .....	37

Query Data Formatter Version .....	37
<b>Chapter 7 RS-232 Interface .....</b>	<b>38</b>
Introduction .....	38
Baud Rate .....	39
Parity Check .....	40
Data Bit .....	41
Stop Bit .....	41
Hardware Auto Flow Control .....	42
<b>Chapter 8 USB Interface .....</b>	<b>43</b>
Introduction .....	43
USB HID Keyboard .....	44
USB Country Keyboard Types .....	45
Beep on Unknown Character .....	49
Emulate ALT+Keypad .....	50
Code Page .....	51
Unicode Encoding .....	53
Emulate Keypad with Leading Zero .....	53
Function Key Mapping .....	54
ASCII Function Key Mapping Table .....	55
ASCII Function Key Mapping Table (Continued) .....	56
Inter-Keystroke Delay .....	57
Caps Lock .....	58
Convert Case .....	59
Emulate Numeric Keypad .....	60
Fast Mode .....	62
Polling Rate .....	63
USB CDC .....	65
HID POS (POS HID Barcode Scanner) .....	65
Introduction .....	65
Access the Scanner with Your Program .....	65
Acquire Scanned Data .....	66
Send Command to the Scanner .....	66
IBM SurePOS (Tabletop) .....	67
IBM SurePOS (Handheld) .....	67
VID/PID .....	67
Adaptive Wired Communication .....	68

<b>Chapter 9 Symbologies</b> .....	<b>69</b>
Introduction .....	69
Global Settings.....	69
Enable/Disable All Symbologies.....	69
Enable/Disable 1D Symbologies.....	69
Enable/Disable 2D Symbologies.....	70
Enable/Disable Postal Symbologies .....	70
1D Twin Code .....	71
Code 128 .....	72
Restore Factory Defaults .....	72
Enable/Disable Code 128 .....	72
Set Length Range for Code 128 .....	73
EAN-8 .....	74
Restore Factory Defaults .....	74
Enable/Disable EAN-8 .....	74
Transmit Check Character .....	74
2-Digit Add-On Code.....	75
5-Digit Add-On Code.....	76
Add-On Code Required .....	77
Convert EAN-8 to EAN-13 .....	77
EAN-13 .....	78
Restore Factory Defaults .....	78
Enable/Disable EAN-13 .....	78
Transmit Check Character .....	79
2-Digit Add-On Code.....	79
5-Digit Add-On Code.....	80
Add-On Code Required .....	80
EAN-13 Beginning with 290 Add-On Code Required .....	81
EAN-13 Beginning with 378/379 Add-On Code Required .....	81
EAN-13 Beginning with 414/419 Add-On Code Required .....	82
EAN-13 Beginning with 434/439 Add-On Code Required .....	82
EAN-13 Beginning with 977 Add-On Code Required .....	83
EAN-13 Beginning with 978 Add-On Code Required .....	83
EAN-13 Beginning with 979 Add-On Code Required .....	84
UPC-E.....	85
Restore Factory Defaults .....	85
Transmit Check Character .....	85

2-Digit Add-On Code .....	85
5-Digit Add-On Code .....	86
Add-On Code Required .....	87
Transmit Preamble Character .....	87
Convert UPC-E to UPC-A .....	87
UPC-A .....	88
Restore Factory Defaults .....	88
Enable/Disable UPC-A .....	88
Transmit Check Character .....	89
2-Digit Add-On Code .....	89
5-Digit Add-On Code .....	91
Add-On Code Required .....	92
Transmit Preamble Character .....	92
Coupon .....	93
UPC-A/EAN-13 with Extended Coupon Code .....	93
Coupon GS1 Databar Output .....	94
Interleaved 2 of 5 .....	95
Restore Factory Defaults .....	95
Enable/Disable Interleaved 2 of 5 .....	95
Set Length Range for Interleaved 2 of 5 .....	96
Check Character Verification .....	97
Febraban .....	98
Disable/Enable Febraban .....	98
Transmit Delay per Character .....	98
Transmit Delay per 12 Characters .....	101
ITF-14 .....	103
Restore Factory Defaults .....	103
Enable/Disable ITF-14 .....	103
ITF-6 .....	104
Restore Factory Defaults .....	104
Enable/Disable ITF-6 .....	104
Matrix 2 of 5 .....	105
Restore Factory Defaults .....	105
Enable/Disable Matrix 2 of 5 .....	105
Set Length Range for Matrix 2 of 5 .....	106
Check Character Verification .....	107
Code 39 .....	108
Restore Factory Defaults .....	108



Enable/Disable Code 39 .....	108
Set Length Range for Code 39 .....	109
Check Character Verification.....	110
Transmit Start/Stop Character.....	111
Enable/Disable Code 39 Full ASCII .....	111
Enable/Disable Code 32 (Italian Pharma Code) .....	112
Code 32 Prefix .....	112
Transmit Code 32 Start/Stop Character .....	113
Transmit Code 32 Check Character .....	113
Codabar .....	114
Restore Factory Defaults .....	114
Enable/Disable Codabar .....	114
Set Length Range for Codabar .....	115
Check Character Verification.....	116
Start/Stop Character .....	117
Code 93 .....	118
Restore Factory Defaults .....	118
Enable/Disable Code 93 .....	118
Set Length Range for Code 93 .....	119
Check Character Verification.....	120
China Post 25.....	121
Restore Factory Defaults .....	121
Enable/Disable China Post 25 .....	121
Set Length Range for China Post 25 .....	122
Check Character Verification.....	123
GS1-128 (UCC/EAN-128) .....	124
Restore Factory Defaults .....	124
Enable/Disable GS1-128.....	124
Set Length Range for GS1-128.....	125
GS1 Databar (RSS) .....	126
Restore Factory Defaults .....	126
Enable/Disable GS1 Databar .....	126
Transmit Application Identifier "01" .....	127
GS1 Composite (EAN-UCC Composite) .....	127
Restore Factory Defaults .....	127
Enable/Disable GS1 Composite.....	127
Enable/Disable UPC/EAN Composite.....	128
Code 11.....	128

Restore Factory Defaults .....	128
Enable/Disable Code 11.....	128
Set Length Range for Code 11.....	129
Check Character Verification.....	130
Transmit Check Character .....	131
ISBN.....	132
Restore Factory Defaults .....	132
Enable/Disable ISBN .....	132
Set ISBN Format.....	133
ISSN.....	134
Restore Factory Defaults .....	134
Enable/Disable ISSN .....	134
Industrial 25.....	135
Restore Factory Defaults .....	135
Enable/Disable Industrial 25 .....	135
Set Length Range for Industrial 25 .....	136
Check Character Verification.....	137
Standard 25.....	138
Restore Factory Defaults .....	138
Enable/Disable Standard 25 .....	138
Set Length Range for Standard 25 .....	139
Check Character Verification.....	140
Plessey .....	141
Restore Factory Defaults .....	141
Enable/Disable Plessey .....	141
Set Length Range for Plessey .....	142
Check Character Verification.....	143
MSI-Plessey.....	144
Restore Factory Defaults .....	144
Enable/Disable MSI-Plessey.....	144
Set Length Range for MSI-Plessey.....	145
Check Character Verification.....	146
Transmit Check Character .....	147
AIM 128.....	148
Restore Factory Defaults .....	148
Enable/Disable AIM 128.....	148
Set Length Range for AIM 128.....	149
ISBT 128 .....	150

Restore Factory Defaults .....	150
Enable/Disable ISBT 128 .....	150
COOP 25 .....	151
Restore Factory Defaults .....	151
Enable/Disable COOP 25 .....	151
Set Length Range for COOP 25 .....	152
Check Character Verification.....	153
PDF417 .....	154
Restore Factory Defaults .....	154
Enable/Disable PDF417.....	154
Set Length Range for PDF417.....	155
PDF417 Twin Code .....	156
PDF417 Inverse .....	157
Character Encoding .....	157
PDF417 ECI Output .....	158
QR Code .....	159
Restore Factory Defaults .....	159
Enable/Disable QR Code .....	159
Set Length Range for QR Code .....	160
QR Inverse .....	161
Character Encoding .....	161
QR ECI Output.....	162
Aztec .....	163
Restore Factory Defaults .....	163
Enable/Disable Aztec Code.....	163
Set Length Range for Aztec Code.....	164
Read Multi-barcodes on an Image .....	165
Set the Number of Barcodes.....	166
Character Encoding .....	167
Aztec ECI Output .....	167
Data Matrix.....	168
Restore Factory Defaults .....	168
Enable/Disable Data Matrix.....	168
Set Length Range for Data Matrix.....	169
Data Matrix Twin Code.....	170
Rectangular Barcode .....	171
Data Matrix Inverse.....	171
Character Encoding .....	172

Data Matrix ECI Output.....	172
<b>Chapter 10 Data Formatter .....</b>	<b>173</b>
Introduction .....	173
Add a Data Format.....	173
Programming with Barcodes.....	173
Programming with Serial Commands.....	176
Enable/Disable Data Formatter .....	177
Non-Match Error Beep .....	178
Data Format Selection .....	179
Change Data Format for a Single Scan .....	180
Clear Data Format.....	181
Query Data Formats.....	181
Formatter Command Type 6 .....	182
Send Commands .....	182
Move Commands.....	185
Search Commands .....	187
Miscellaneous Commands .....	190
<b>Chapter 11 Prefix &amp; Suffix.....</b>	<b>196</b>
Introduction .....	196
Global Settings.....	197
Enable/Disable All Prefixes/Suffixes.....	197
Prefix Sequence.....	197
Custom Prefix.....	198
Enable/Disable Custom Prefix .....	198
Set Custom Prefix .....	198
AIM ID Prefix.....	199
Code ID Prefix.....	200
Restore All Default Code IDs .....	200
Modify Code ID .....	200
Custom Suffix.....	207
Enable/Disable Custom Suffix.....	207
Set Custom Suffix .....	207
Data Packing.....	208
Introduction .....	208
Data Packing Options .....	208
Terminating Character Suffix.....	210
Enable/Disable Terminating Character Suffix.....	210

Set Terminating Character Suffix.....	210
<b>Chapter 12 Batch Programming.....</b>	<b>212</b>
Introduction .....	212
Create a Batch Command.....	213
Create a Batch Barcode.....	213
Use Batch Barcode .....	214
<b>Chapter 13 PS/2 Interface .....</b>	<b>215</b>
Introduction .....	215
<b>Chapter 14 Handheld Barcode Scanner Access.....</b>	<b>216</b>
Introduction .....	216
<b>Appendix .....</b>	<b>219</b>
Digit Barcodes.....	219
Save/Cancel Barcodes.....	222
Factory Defaults Table .....	223
AIM ID Table.....	230
Code ID Table .....	232
Symbology ID Number .....	233
ASCII Table .....	234
Unicode Key Maps .....	238



# Preface

## Introduction

This manual provides detailed instructions for setting up and using the NLS-FR80 desktop barcode scanner (hereinafter referred to as “**the FR80**” or “**the scanner**”).

This guide provides programming instructions for the FR80. Users can configure the FR80 by scanning the programming barcodes included in this manual.

The FR80 has been properly configured for most applications and can be put into use without further configuration. Users may check Appendix: Factory Defaults Table for reference. Throughout the manual, programming barcodes marked with asterisks (\*\*) are factory default values.

## Explanation of Icons



This icon indicates something relevant to this manual.



This icon indicates this information requires extra attention from the reader.



This icon indicates handy tips that can help you use or configure the scanner with ease.



This icon indicates practical examples that can help you to acquaint yourself with operations.

# Chapter 1 Getting Started

## Introduction

The NLS-FR80 barcode scanner (hereinafter referred to as “the FR80” or “the scanner”), armed with the Newland patented **UIMG**, a computerized image recognition system, blends image recognition algorithm & manufacturing, which significantly simplifies application design and delivers superior performance and solid reliability.

## Application Scenarios

The FR80 is mainly applied for the retail industry, such as supermarkets, convenience stores, tobacco and alcohol counters, commercial centers, etc.

## Symbologies

The FR80 can easily read printed barcodes and on-screen barcodes, including:

1D	Code11, Code128, Code39, GS1-128(UCC/EAN12), AIM128, ISBT128, CodaBar, Code93, UPC-A/UPC-E, Coupon, EAN-13, EAN-8, ISSN, ISBN, Interleaved2/5, Matrix2/5, Industrial2/5, ITF-14, ITF-6, Standard2/5, China Post 25, MSI-Plessey, Plessey, GS1 Databar Composite, GS1 Databar(RSS)
2D	PDF417, QR code, Aztec, Data Matrix

## Features

- Support external handheld barcode scanner
- Volume and sound effect keys, support self-adjustment
- Multi-colored LED indicator, alarm function and real-time feedback of device status
- Fixed bracket, flexible to help users install and fix the scanner



---

## FR80 Scanner

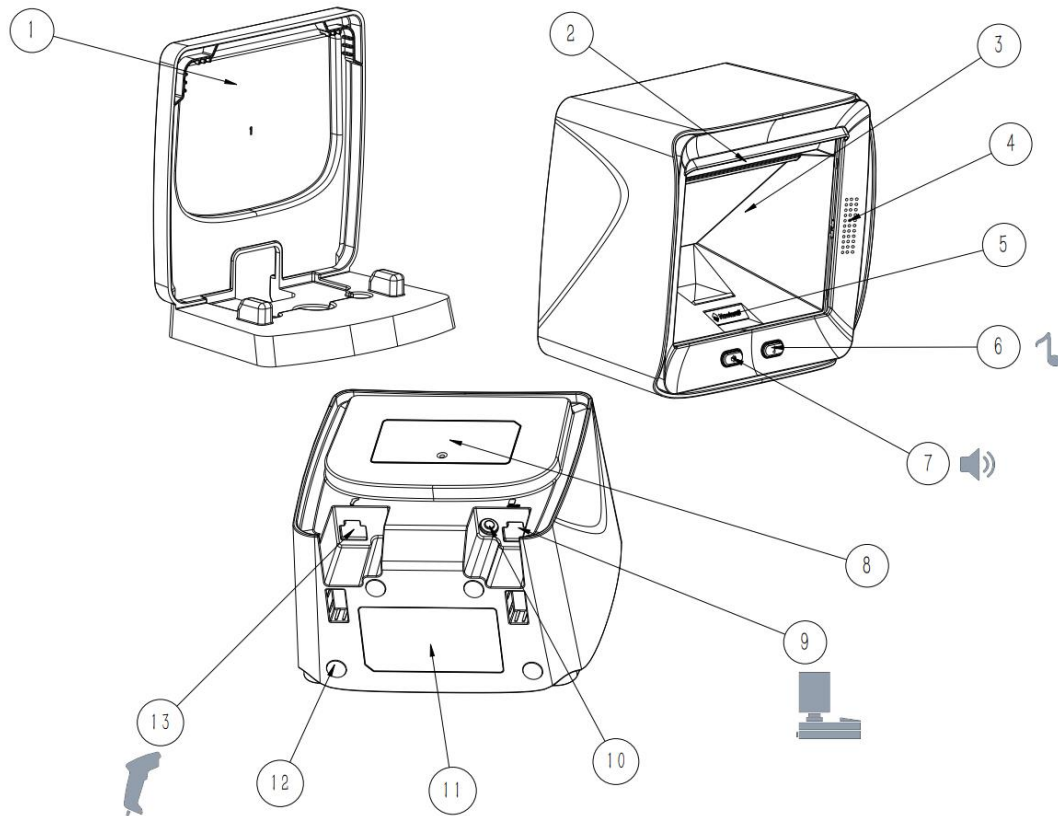



Figure 1-1

- ① Fixed seat
- ② Illumination LED
- ③ Scan Window
- ④ Sound hole
- ⑤ Status indicator
- ⑥ Sound effect key
- ⑦ Volume key
- ⑧ Position of logo
- ⑨ Main RJ45 port
- ⑩ DC port
- ⑪ Position of label
- ⑫ Position of pad
- ⑬ Secondary RJ45 port

# Chapter 2 Installation

## Introduction

This chapter mainly explains how to install the FR80.

 Caution: Please do not disassemble the FR80 to avoid any damage to the device.

## General Requirements

### Prevention of Water

It is recommended to keep the scanner away from water when using it. Do not place cups filled with water and drink on the scanner and spray any liquid on the FR80.

### Dust and Dirt

The FR80 should be used in a relatively clean environment and do not expose the device to dust and stain.

### Ambient Environment

The following environmental requirements should be met to ensure good performance of the FR80.

**Table 2-1**

Operating Temperature	-20°C~50°C
Storage Temperature	-40°C~70°C
Humidity	5% to 95% (non-condensing)

---

## **Optical Elements**

The optical components of FR80 are integrated inside the device, and it is forbidden to disassemble or replace optical components.

During installation and use, do not scratch the window with sharp objects.

If the surface of the screen is contaminated, use a cloth with alcohol or water to wipe the surface.

---

## Mounting

Without bracket

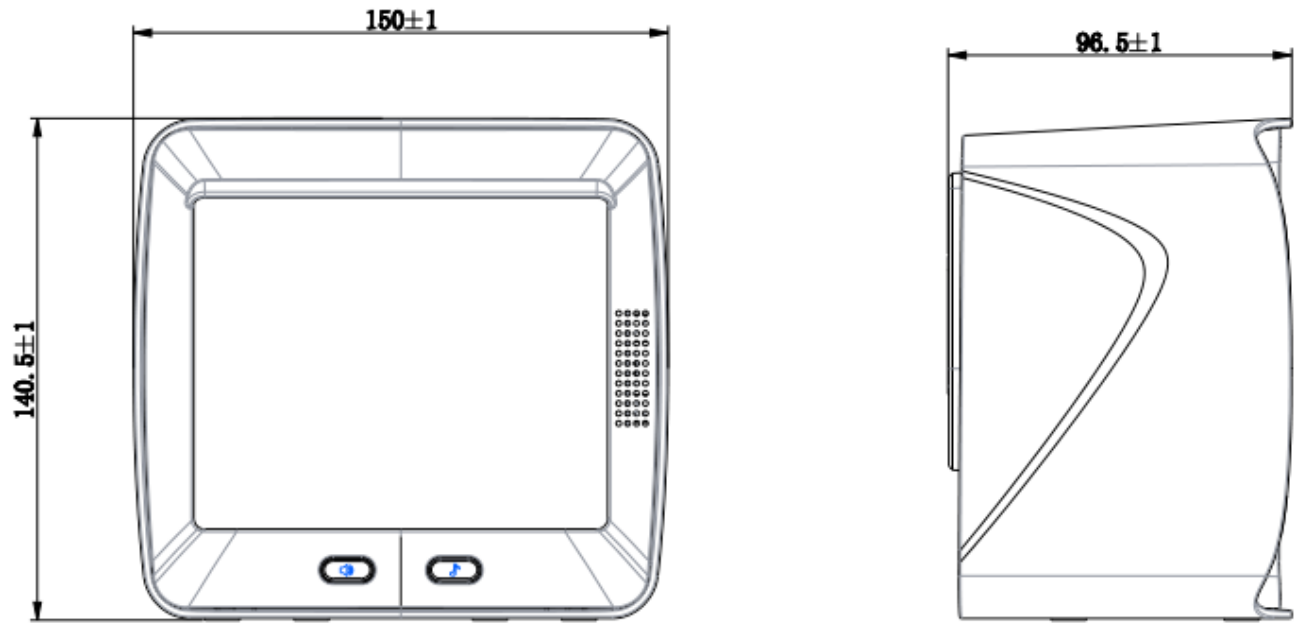

Figure 2-1

---

With bracket

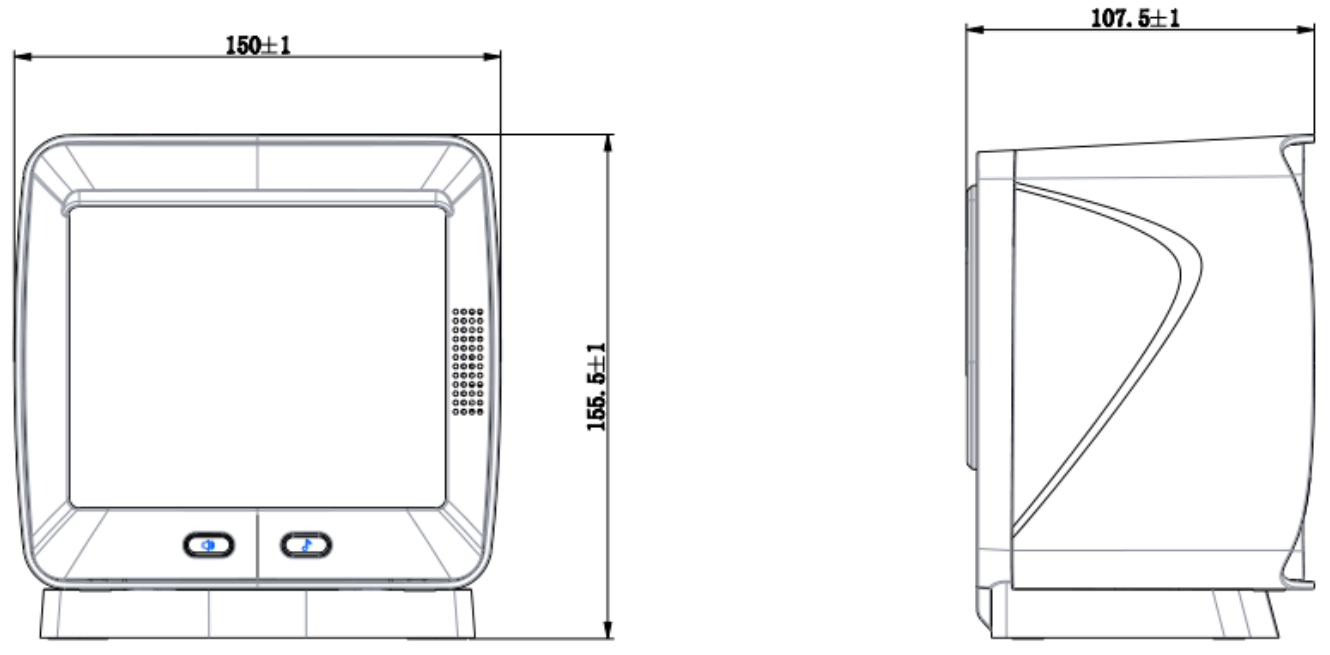

Figure 2-2

---

## Installation of Optional Base

Please fix the base on the desktop through screw holes according to Figure 2-4, and then install the FR80 as shown in Figure 2-3 if necessary.

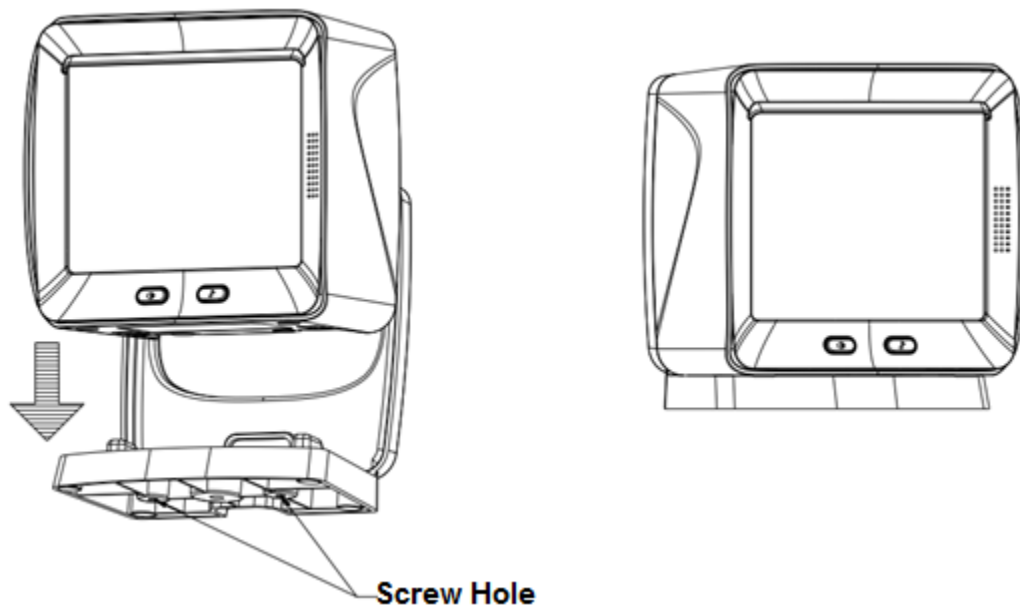

Figure 2-3 Installation of Base

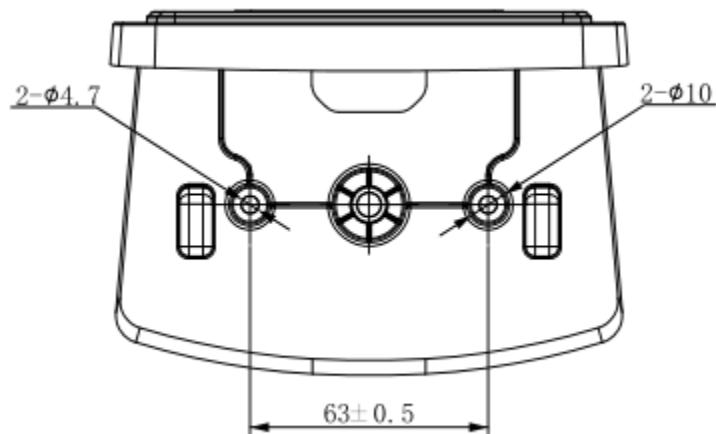

Figure 2-4 Dimensions

---

## **Ambient Light**

The FR80 shows better performance with ambient light. However, high-frequency pulsed light can result in performance degradation.

## **Eye Safety**

The FR80 uses an LED to produce illumination beam. The LED is bright, but testing has been done to demonstrate that the scanner is safe for its intended application under normal usage conditions.

## Chapter 3 Interfaces and Electrical Specifications

### Interface Pinouts

NLS-FR80 has three external physical interfaces:

The DC interface is used to connect the 5V DC adapter for the FR80. The main RJ45 interface can be used to communicate with the host. The secondary RJ45 interface is used to connect the handheld barcode scanner.

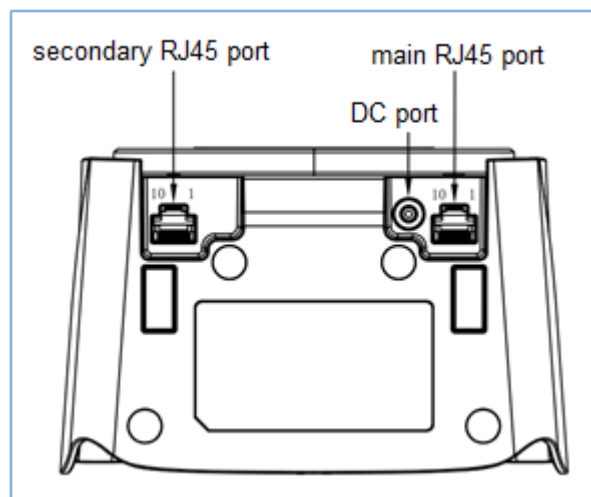

Figure 3-1

### Adapter and DC Interface

The DC adapter for the FR80 has a power supply capability of 5V/1.5A.



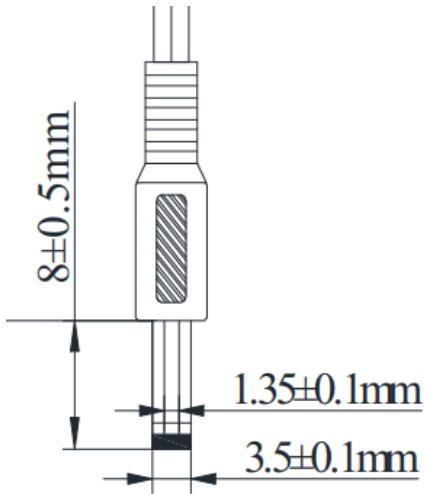

Figure 3-2

The following table lists the pin functions of the 10-pin connector for the main RJ45 interface and secondary RJ45 interface.

**Table 3-1**

**Main RJ45 interface**

PIN#	Signal	I/O	Function	Remark
1	EF_3V3	O	Good read indicator/ for other functions	3.3V
2	EF_5V	O	Good read indicator/ for other functions	5V
3	VCC5V	I	5V power input	
4	RS232_TX	O	RS-232 level TX output	to connect the host
5	RS232_RX	I	RS-232 level RX input	to connect the host
6	RS232_CTS	I	RS-232 level CTS input	to connect the host
7	RS232_RTS	O	RS-232 level RTS output	to connect the host
8	GND	Ground	Ground	
9	USB_D-	I/O	USB_D-	
10	USB_D+	I/O	USB_D+	

---

**Table 3-2**

**Secondary RJ45 interface**

<b>PIN#</b>	<b>Signal</b>	<b>I/O</b>	<b>Function</b>	<b>Remark</b>
1	EF_IN#	I	Reserved interrupt signal input (low level is valid)	3.3V level
2	EF_OUT	O	Good read indicator/ for other functions	5V level
3	5V_OUT	O	5V power output (for the handheld barcode scanner)	
4	EX_RX	I	RS-232 level RX input	to connect the handheld barcode scanner
5	EX_TX	O	RS-232 level TX output	to connect the handheld barcode scanner
6	EX_RTS	O	RS-232 level RTS output	to connect the handheld barcode scanner
7	EX_CTS	I	RS-232 level CTS input	to connect the handheld barcode scanner
8	GND	Ground	Ground	
9	Antenna-	I/O	Reserved aerial interface	
10	Antenna+	I/O	Reserved aerial interface	

---

## Connect to the Host

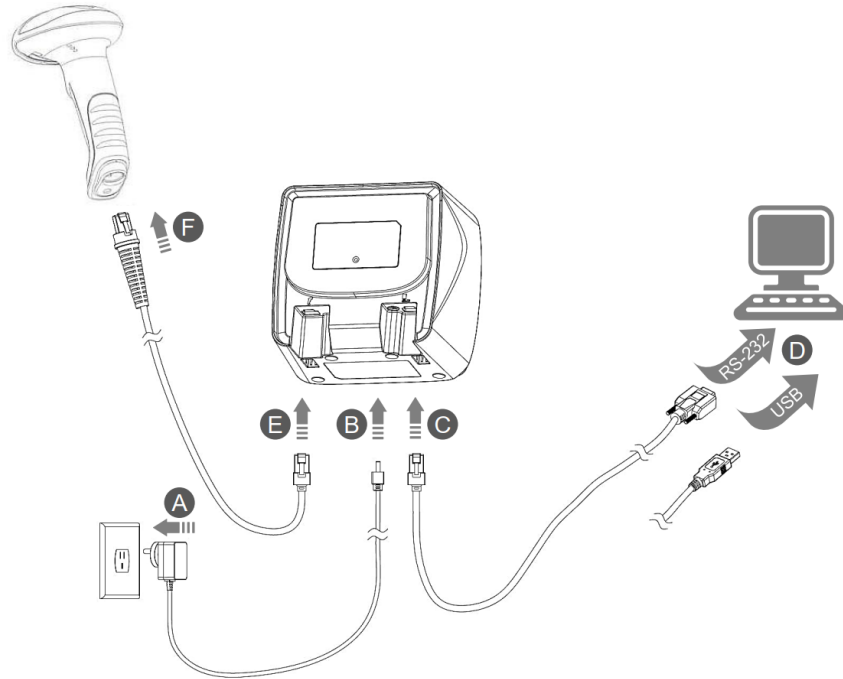

Figure 3-3

### Power on

1. For the FR80 with the adapter, connect the adapter first and power on the FR80 according to step A and step B in Figure 3-3. Then connect the data cable (USB data cable or RS-232 data cable) according to step C and step D. Finally connect the handheld barcode scanner if needed, following step E and step F. The power-on duration is about 4 seconds.
2. For the FR80 without the adapter, handheld barcode scanner access is not available. It supports power supply via the USB port according to step C and step D. The power-on duration is about 10 seconds.
3. It is not allowed to connect the non-standard and damaged adapter and forbid conducting step B without step A.
4. If you do not hear the power-on beep after powering the device on for more than 30 seconds, it means that the power supply is insufficient and the device will emit an alarm.

### Power off

1. For the FR80 with the adapter, disconnect the data cable (USB data cable or RS-232 data cable) firstly, then unplug the adapter and finally pull out the handheld barcode scanner.
  2. For the FR80 without the adapter, directly disconnect the data cable.
-

---

## Electrical Specifications

Parameter	Description
Voltage	AC output (adapter): 100~240Vac, 50~60Hz DC input ( DC interface and main RJ45 interface): 4.75~5.25V
Power Consumption	2.5W (max) 2W (typical) 1.25W (standby)

Note: When powering the FR80 via the main RJ45 interface without the adapter, ensure that power supply has a load capacity of more than 500mA and the range of power supply voltage should be  $5.0V \pm 5\%$ . The power input ripple must not exceed 150mV. For the power-on and power-off operation, please refer to the FR80 Quick Start.

## Chapter 4 Operating Instructions

### Introduction

Use the FR80 after it is installed and make sure power-on and communication state is normal. The scanner adopts the sensor mode (default). When it is not used for a long time, the illumination LED will be off, and only the sensor LED will remain on. When the object appears on the window, the illumination LED will be automatically on and the scanner will start to decode the barcode and transmit the data.

### Barcode Scanning

1. Make sure that the scanner, the data cable, the host and power supply are properly connected and powered on normally.
2. Place the barcode in the field of view as shown in Figure 4-1 and aim it at the scan window. The illumination LED will be activated, the red illumination area will appear and the decoding process will begin.
3. When the good read beep sounds and the green LED is on, it indicates the decoding is successful. The scanner will transmit the decoded data to the host.
4. The optimal scanning distance is about 7cm away from the scan window.

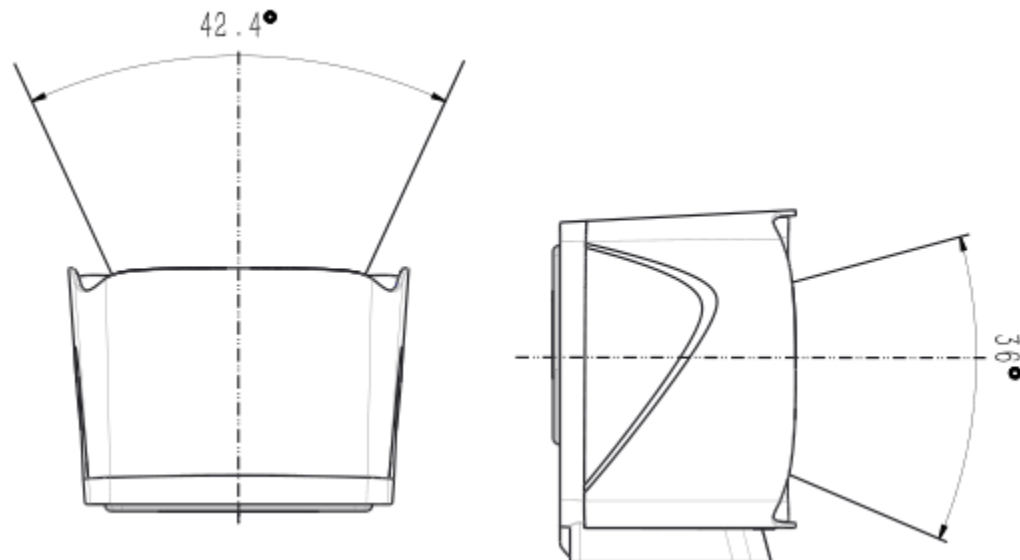

Figure 4-1 Field of View

---

## Status Indicator

Blue LED on: initialization or configuration process

Green LED on: It indicates successful decode

Cyan LED on: configuration is successful

Purple LED on: configuration error

Yellow LED on: The decoding is successful but an alarm is emitted due to data transmission failure. Please check if the data cable connection is loose.

Red LED on: An alarm occurs because of barcode scanning module malfunction. Please contact technical support.

Red LED flashes: An alarm for low input voltage. For the FR80 with the adapter, please check whether power supply of the adapter is normal. For the FR80 without the adapter, it may be because of insufficient power supply of the USB interface.

## Keys

Sound effect key: used to select sound effects of good read beep (default: five options);

Volume key: used to adjust the volume of good read beep (default: low, medium and high levels);

## Maintenance

- ✧ The scan window should be kept clean.
- ✧ Do not scratch the scan window.
- ✧ Use soft brush to remove the stain from the scan window.
- ✧ Use the soft cloth to clean the window, such as eyeglass cleaning cloth.
- ✧ Do not spray any liquid on the scan window.
- ✧ Do not use any detergent to clean other parts of the device except for water and alcohol.

**Note: The warranty DOES NOT cover damages caused by inappropriate care and maintenance.**

## Chapter 5 EasySet

EasySet, developed by Fujian Newland Auto-ID Tech. Co., Ltd., is a configuration tool for Newland's 1D/2D handheld barcode scanner, desktop barcode scanners and OEM scan engines. Its main features include:

- ✧ View device & configuration information of online device
- ✧ Configure device
- ✧ Update firmware of online device
- ✧ Load/modify existing XML configuration file; save current settings to an XML file
- ✧ Create/print/save programming barcodes to a PDF or Word file
- ✧ View/edit/save image stored on online device in the original image/BMP/JPG/TIFF format
- ✧ Send serial commands to online device and receive device response
- ✧ Supported languages: Chinese and English.

EasySet supports 32-bit/64-bit Microsoft WinXP/Win7/Win 8/Win 8.1/Win 10 operating systems.

EasySet can communicate with device via one of the following interface: RS-232, USB COM Port Emulation (UFCOM driver required), USB CDC (UFCOM driver required), USB DataPipe (UFCOM driver required), USB HID-POS.

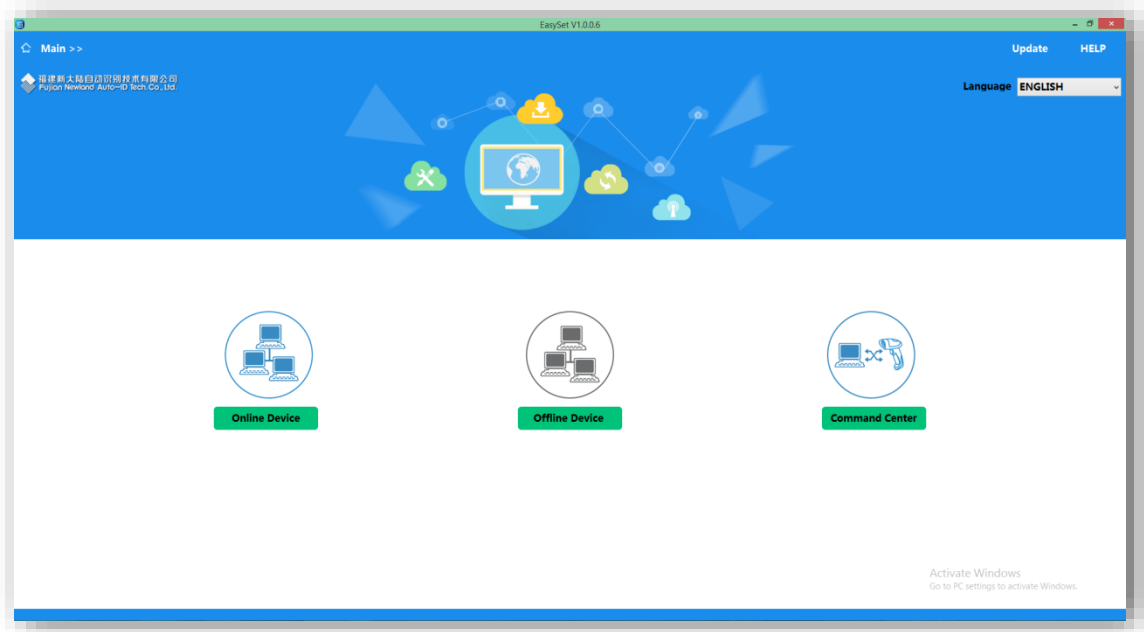



@SETUPE1  
Enter Setup

## Chapter 6 System Settings

### Introduction

There are three ways to configure the FR80: Barcode programming, command programming and Easyset programming.

#### Barcode Programming

The FR80 can be configured by scanning programming barcodes. All user programmable features/options are described along with their programming barcodes/commands in the following sections.

This programming method is most straightforward. However, it requires manually scanning barcodes. As a result, errors are more likely to occur.

#### Command Programming

The FR80 can also be configured by serial commands sent from the host device.

Users can design an application program to send those command strings to the scanners to perform device configuration.

For more information, refer to the *Programming Guide Based on Newland Unified Commands Set*.

#### EasySet Programming

Besides the two methods mentioned above, you can conveniently perform scanner configuration through EasySet too. EasySet is a Windows-based configuration tool particularly designed for Newland products, enabling users to gain access to decoded data and captured images and to configure scanners. For more information about this tool, refer to the *EasySet User Guide*.



@SETUPE0  
\*\* Exit Setup





@SETUPE1  
Enter Setup

## Programming Barcode/ Programming Command/Function



The figure above is an example that shows you the programming barcode and command for the Enter Setup function:

1. The **No Case Conversion** barcode.
2. The **No Case Conversion** command.
3. The description of feature/option.
4. \*\* indicates factory default settings.

Note: “@” included in the programming command indicates permanent setting which means the setting will not be lost by removing power from the scanner or turning off or rebooting it; whereas “#” included in the programming command indicates temporary setting which means the setting will be lost by removing power from the scanner or turning off or rebooting it.

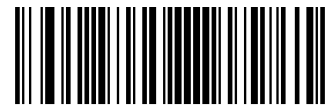

@SETUPE0  
\*\* Exit Setup



@SETUPE1  
Enter Setup

---

## Use of Programming Command

Besides the barcode programming method, the scanner can also be configured by serial commands (HEX) sent from the host device. **All commands must be entered in uppercase letters.**

### Command Syntax

*Prefix StorageType Tag SubTag {Data} [,SubTag {Data}] [:Tag SubTag {Data}] [...] Suffix*

**Prefix:** "~<SOH>0000" (HEX: **7E 01 30 30 30 30**), 6 characters.

**StorageType:** "@" (HEX: **40**) or "#" (HEX: **23**), 1 character. "@" means permanent setting which will not be lost by removing power from the scanner or rebooting it; "#" means temporary setting which will be lost by removing power from the scanner or rebooting it.

**Tag:** A 3-character case-sensitive field that identifies the desired command group. For example, all USB HID Keyboard configuration settings are identified with a Tag of KBW.

**SubTag:** A 3-character case-sensitive field that identifies the desired parameter within the tag group. For example, the SubTag for the keyboard layout is CTY.

**Data:** The value for a feature or parameter setting, identified by the Tag and SubTag.

**Suffix:** ";<ETX>" (HEX: **3B 03**), 2 characters.

Multiple commands can be issued within one Prefix/Suffix sequence. For configuration commands, only the **Tag**, **SubTag**, and **Data** fields must be repeated for each command in sequence. If an additional command is to be applied to the same Tag, then the command is separated with a comma (,) and only the **SubTag** and **Data** fields of the additional commands are issued. If the additional command requires a different **Tag** field, the command is separated from previous command by a semicolon (;).

### Query Commands

For query commands, the entry in the **Data** field in the syntax above is one of the following characters means:

- \* (HEX: **2A**)      What is the scanner's current value for the setting(s).
- & (HEX: **26**)      What is the factory default value for the setting(s).
- ^ (HEX: **5E**)      What is the range of possible values for the setting(s).



@SETUPE0  
\*\* Exit Setup



@SETUPE1  
Enter Setup

The value of the **StoreType** field in a query command can be either "@" (HEX: 40) or "#" (HEX: 23).

A query command with the **SubTag** field omitted means to query all the settings concerning a tag. For example, to query all the current settings about Code 11, you should enter **7E 01 30 30 30 30 40 43 31 31 2A 3B 03** (i.e. ~<SOH>0000@C11\*;<ETX>).

## Responses

Different from command sequence, the prefix of a response consists of the six characters of "<STX><SOH>0000" (HEX: **02 01 30 30 30 30**).

The scanner responds to serial commands with one of the following three responses:

- <ACK> (HEX: **06**)      Indicates a good command which has been processed.
- <NAK> (HEX: **15**)      Indicates a good configuration command with its **Data** field entry out of the allowable range for this Tag and SubTag combination (e.g. an entry for an inter-keystroke delay of 100 when the field will only allow 2 digits), or an invalid query command.
- <ENQ> (HEX: **05**)      Indicates an invalid Tag or SubTag command.

When responding, the scanner echoes back the command sequence with the status character above inserted directly before each of the punctuation marks (the comma or semicolon) in the command.

## Examples

**Example 1: Enable Code 11, set the minimum and maximum lengths to 12 and 22 respectively.**

Enter:      **7E 01 30 30 30 30 40 43 31 31 45 4E 41 31 2C 4D 49 4E 31 32 2C 4D 41 58 32 32 3B 03**  
(~<SOH>0000@C11ENA1,MIN12,MAX22;<ETX>)

Response: **02 01 30 30 30 30 40 43 31 31 45 4E 41 31 06 2C 4D 49 4E 31 32 06 2C 4D 41 58 32 32 06 3B 03**  
(<STX><SOH>0000@C11ENA1<ACK>,MIN12<ACK>,MAX22<ACK>;<ETX>)

**Example 2: Query the current minimum and maximum lengths of Code 11.**

Enter:      **7E 01 30 30 30 30 40 43 31 31 4D 49 4E 2A 2C 4D 41 58 2A 3B 03**  
(~<SOH>0000@C11MIN\*,MAX\*;<ETX>)

Response: **02 01 30 30 30 30 40 43 31 31 4D 49 4E 31 32 06 2C 4D 41 58 32 32 06 3B 03**  
(<STX><SOH>0000@C11MIN12<ACK>,MAX22<ACK>;<ETX>)

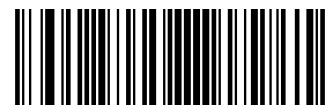

@SETUPE0  
\*\* Exit Setup



@SETUPE1  
**Enter Setup**

---

## Use of Programming Barcodes

Scanning the **Enter Setup** barcode can enable the scanner to enter the setup mode. Then you can scan a number of programming barcodes to configure your scanner. To exit the setup mode, scan the **Exit Setup** barcode or a non-programming barcode, or reboot the scanner.



@SETUPE0  
**\*\* Exit Setup**

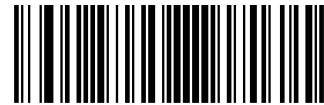

@SETUPE1  
**Enter Setup**

Programming barcode data (i.e. the characters under programming barcode) can be transmitted to the host device. Scan the appropriate barcode below to enable or disable the transmission of programming barcode data to the host device.



@SETUPT0  
**\*\* Do Not Transmit Programming Barcode Data**



@SETUPT1  
**Transmit Programming Barcode Data**



@SETUPE0  
**\*\* Exit Setup**



@SETUPE1  
**Enter Setup**

---

## Power On Beep

The scanner can be programmed to beep when it is powered on. Scan the **Off** barcode if you do not want a power on beep.



@PWBENA1  
**\*\* On**



@PWBENA0  
**Off**

## Good Read Beep

Scanning the **Off** barcode can turn off the beep that indicates successful decode; scanning the **On** barcode can turn it back on.



@GRBENA1  
**\*\* On**



@GRBENA0  
**Off**



@SETUPE0  
**\*\* Exit Setup**



@SETUPE1  
Enter Setup

---

### Good Read Beep Volume



@GRBVLL1  
\*\* Loud



@GRBVLL2  
Medium



@GRBVLL3  
Low



@SETUPE0  
\*\* Exit Setup



@SETUPE1  
**Enter Setup**

---

## Good Read Sound Effect



@GRVFRQ0

**700Hz**



@GRVFRQ1

**1200Hz**



@GRVFRQ2

**1700Hz**



@GRVFRQ3

**2200Hz**



@GRVFRQ4

**\*\* 2730Hz**



@SETUPE0  
**\*\* Exit Setup**



@SETUPE1  
Enter Setup

---

## Scan Mode

- ✧ **Advanced Sense Mode:** The scanner activates a decode session every time it detects a barcode presented to it. The decode session will continue after a barcode is decoded. If the undecoded duration reaches decode session timeout, the scanner will enter the sensor mode. When the scanner detects a barcode presented to it, it will start the decode session again. If rereading of same barcode is required, remove the barcode and then show the barcode on the scan window again.



@SCNMOD15  
Advanced Sense Mode



@SETUPE0  
\*\* Exit Setup





@SETUPE1  
**Enter Setup**

---

## Decode Session Timeout

This parameter sets the maximum time decode session continues during a scan attempt. It is programmable in 1ms increments from 1ms to 3,600,000ms. When it is set to 0, the timeout is infinite. The default setting is 30000ms.



@ORTSET  
**Decode Session Timeout**

**E**  
*sample*

**Set the decode session timeout to 1,500ms:**

1. Scan the **Enter Setup** barcode.
2. Scan the **Decode Session Timeout** barcode.
3. Scan the numeric barcodes “1”, “5”, “0” and “0” from the “Digit Barcodes” section in Appendix.
4. Scan the **Save** barcode from the “Save/Cancel Barcodes” section in Appendix.
5. Scan the **Exit Setup** barcode.

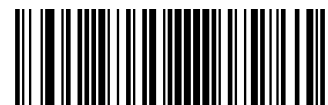

@SETUPE0  
**\*\* Exit Setup**



@SETUPE1  
Enter Setup

---

## Image Stabilization Timeout (Sense Mode)

This parameter defines the amount of time the scanner will spend adapting to ambient environment after it decodes a barcode and “looks” for another. It is programmable in 1ms increments from 0ms to 3,000ms. The default setting is 500ms.



@SENIST  
Image Stabilization Timeout

**E**  
*sample*

**Set the image stabilization timeout to 800ms:**

1. Scan the **Enter Setup** barcode.
2. Scan the **Image Stabilization Timeout** barcode.
3. Scan the numeric barcodes “8”, “0” and “0” from the “Digit Barcodes” section in Appendix.
4. Scan the **Save** barcode from the “Save/Cancel Barcodes” section in Appendix.
5. Scan the **Exit Setup** barcode.



@SETUPE0  
\*\* Exit Setup



@SETUPE1  
Enter Setup

## Image Decoding Timeout

Image Decoding Timeout specifies the maximum time the scanner will spend decoding an image. This parameter is programmable in 1ms increments from 1ms to 3,000ms. The default timeout is 100ms.



@DETSET  
Image Decoding Timeout

**E**  
*xample*

**Set the image decoding timeout to 1,000ms:**

1. Scan the **Enter Setup** barcode.
2. Scan the **Image Decoding Timeout** barcode.
3. Scan the numeric barcodes “1”, “0”, “0” and “0” from the “Digit Barcodes” section in Appendix.
4. Scan the **Save** barcode from the “Save/Cancel Barcodes” section in Appendix.
5. Scan the **Exit Setup** barcode.

## Surround GS1 Application Identifiers (AI's) with Parentheses

When **Surround GS1 AI's with Parentheses** is selected, each application identifier (AI) contained in scanned data will be enclosed in parentheses in the output message.

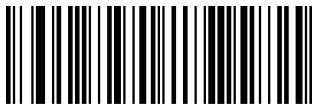

@GS1AIP0

**\*\* Do Not Surround GS1 AI's with Parentheses**



@GS1AIP1

**Surround GS1 AI's with Parentheses**



@SETUPE0  
**\*\* Exit Setup**



@SETUPE1  
Enter Setup

---

**E**  
*xample*

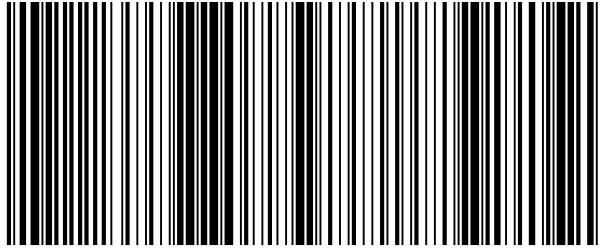

(01) 0 0614141 99999 6 (10) 10ABCEDF123456

If **Surround GS1 AI's with Parentheses** is selected, the barcode above is output as (01)00614141999996(10)10ABCEDF123456.

If **Do Not Surround GS1 AI's with Parentheses** is selected, the barcode above is output as 01006141419999961010ABCEDF123456.



@SETUPE0  
\*\* Exit Setup



@SETUPE1  
Enter Setup

---

## Scanning Preference

**Screen Mode:** Select this mode when reading barcodes on the screen.



@EXPLVL2  
**\*\* Screen Mode**

## Decode Area

**Whole Area Decoding:** The scanner attempts to decode barcode(s) within its field of view, from the center to the periphery, and transmits the barcode that has been first decoded.



@CADENA0  
**\*\* Whole Area Decoding**

## Image Flipping



@MIRROR0  
**\*\* Do Not Flip**



@MIRROR2  
**Flip Vertically**



@MIRROR1  
**Flip Horizontally**



@MIRROR3  
**Flip Horizontally & Vertically**

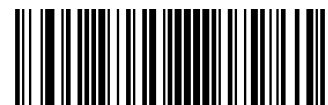

@SETUPE0  
**\*\* Exit Setup**



@SETUPE1  
Enter Setup

Example of image not flipped



Example of image flipped horizontally



Example of image flipped vertically



Example of image flipped horizontally & vertically



## Bad Read Message

Scan the appropriate barcode below to select whether or not to send a bad read message (user-programmable) when a good read does not occur before trigger release, or the decode session timeout expires, or the scanner receives the **Stop Scanning** command (For more information, see the “Serial Trigger Command” section in this Chapter).



@NGRENA0

**\*\* Bad Read Message OFF**



@NGRENA1

**Bad Read Message ON**

## Set Bad Read Message

A bad read message can contain up to 7 characters (HEX values from 0x00 to 0xFF). To set a bad read message, scan the



@SETUPE0  
**\*\* Exit Setup**



@SETUPE1

**Enter Setup**

**Set Bad Read Message** barcode, the numeric barcodes representing the hexadecimal values of desired character(s) and the **Save** barcode. The default setting is “NG”.



@NGRSET

**Set Bad Read Message**

**E**  
*sample*

**Set the bad read message to “F” (HEX: 0x46):**

1. Scan the **Enter Setup** barcode.
2. Scan the **Set Bad Read Message** barcode.
3. Scan the numeric barcodes “4” and “6” from the “Digit Barcodes” section in Appendix.
4. Scan the **Save** barcode from the “Save/Cancel Barcodes” section in Appendix.
5. Scan the **Exit Setup** barcode.

## Default Settings

### Factory Defaults

Scanning the following barcode can restore the scanner to the factory defaults.

You may need to reset all parameters to the factory defaults when:

- ✧ scanner is not properly configured so that it fails to decode barcodes.
- ✧ you forget previous configuration and want to avoid its impact.



@FACDEF

**Restore All Factory Defaults**

### Custom Defaults

Scanning the **Restore All Custom Defaults** barcode can reset all parameters to the custom defaults. Scanning the **Save as Custom Defaults** barcode can set the current settings as custom defaults.

Custom defaults are stored in the non-volatile memory.

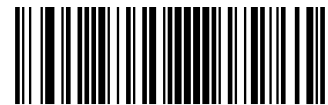

@SETUPE0

**\*\* Exit Setup**



@SETUPE1  
**Enter Setup**

---



@CUSSAV  
**Save as Custom Defaults**



@CUSDEF  
**Restore All Custom Defaults**



Restoring the scanner to the factory defaults will not remove the custom defaults from the scanner.

## Query Product Information

After scanning the barcode below, the product information (including product name, firmware version, decoder version, hardware version, product serial number, OEM serial number and manufacturing date) will be sent to the host device.



@QRYSYS  
**Query Product Information**



@SETUPE0  
**\*\* Exit Setup**





@SETUPE1  
**Enter Setup**

---

**Query Product Name**



@QRYPDN  
**Query Product Name**

**Query Firmware Version**



@QRYFWW  
**Query Firmware Version**



@SETUPE0  
**\*\* Exit Setup**



@SETUPE1  
Enter Setup

---

### Query Decoder Version



@QRYDCV  
Query Decoder Version

### Query Hardware Version



@QRYHWW  
Query Hardware Version

### Query Product Serial Number



@QRYPSN  
Query Product Serial Number



@SETUPE0  
\*\* Exit Setup



@SETUPE1  
**Enter Setup**

---

### Query Manufacturing Date



@QRYDAT  
**Query Manufacturing Date**

### Query OEM Serial Number



@QRYESN  
**Query OEM Serial Number**

### Query Data Formatter Version



@QRYDFM  
**Query Data Formatter Version**



@SETUPE0  
**\*\* Exit Setup**



@SETUPE1  
Enter Setup

## Chapter 7 RS-232 Interface

### Introduction

When the scanner is connected to the RS-232 port of a host device, the scanner will automatically enable RS-232 communication. However, you need to set communication parameters (including baud rate, parity check, data bit and stop bit) on the scanner to match the host device so that two devices can communicate with each other.



@INTERF0  
RS-232



@SETUPE0  
\*\* Exit Setup



@SETUPE1  
**Enter Setup**

---

## Baud Rate

Baud rate is the number of bits of data transmitted per second. Set the baud rate to match the host requirements.



@232BAD8  
**115200**



@232BAD7  
**57600**



@232BAD6  
**38400**



@232BAD5  
**19200**



@232BAD4  
**14400**



@232BAD3  
**\*\* 9600**



@232BAD2  
**4800**



@232BAD1  
**2400**

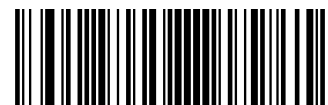

@SETUPE0  
**\*\* Exit Setup**



@SETUPE1  
Enter Setup

---

## Parity Check

Set the parity type to match the host requirements.

- ◇ **Odd Parity:** If the data contains an odd number of 1 bits, the parity bit value is set to 0.
- ◇ **Even Parity:** If the data contains an even number of 1 bits, the parity bit value is set to 0.
- ◇ **None:** Select this option when no parity bit is required.



@232PAR0  
\*\* None



@232PAR1  
Even Parity



@232PAR2  
Odd Parity



@SETUPE0  
\*\* Exit Setup



@SETUPE1  
**Enter Setup**

---

## Data Bit

Set the number of data bits to match the host requirements.



@232DAT1  
**7 Data Bits**



@232DAT0  
**\*\* 8 Data Bits**

## Stop Bit

The stop bit(s) at the end of each transmitted character marks the end of transmission of one character and prepares the receiving device for the next character in the serial data stream. Set the number of stop bits to match the host requirements.



@232STP0  
**\*\* 1 Stop Bit**



@232STP1  
**2 Stop Bits**

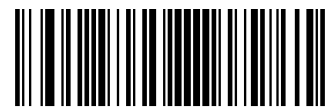

@SETUPE0  
**\*\* Exit Setup**



@SETUPE1  
Enter Setup

---

## Hardware Auto Flow Control

If this feature is enabled, the scanner determines whether to transmit data based on CTS signal level. When CTS signal is at a low level which means the serial port's cache memory of receiving device (such as PC) is full, the scanner sends data through RS-232 port until CTS signal is set to high level by receiving device. When the scanner is not ready for receiving, it will set RTS signal to low level. When sending device (such as PC) detects it, it will not send data to the scanner any more to prevent data loss.

If this feature is disabled, reception/transmission of serial data will not be influenced by RTS/CTS signal.



@232AFL0

**\*\* Disable Hardware Auto Flow Control**



@232AFL1

**Enable Hardware Auto Flow Control**



Before enabling this feature, make sure that RTS/CTS signal lines are contained in RS-232 cable. Without the signal lines, RS-232 communication errors will occur.



@SETUPE0

**\*\* Exit Setup**





@SETUPE1  
Enter Setup

## Chapter 8 USB Interface

### Introduction

There are four options for USB connection:

- ✧ USB HID Keyboard: The scanner's transmission is simulated as USB keyboard input with no need for command configuration or a driver. Barcode data could be entered by the virtual keyboard directly and it is also convenient for the host device to receive data.
- ✧ USB CDC: It is compliant with the standard USB CDC class specifications defined by the USB-IF and allows the host device to receive data in the way as a serial port does. A driver is needed when using this feature.
- ✧ HID POS (POS HID Barcode Scanner): It is based on the HID interface, with no need for a custom driver. It excels virtual keyboard and traditional RS-232 interface in transmission speed.
- ✧ IBM SurePOS: It conforms to IBM (now Toshiba Global Commerce Solutions) 4698 USB scanner interface specifications.

When the scanner is connected to both USB and RS-232 ports on a host device, it will select the USB connection by default.

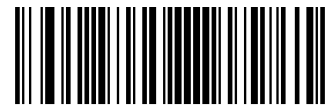

@SETUPE0  
\*\* Exit Setup



@SETUPE1  
Enter Setup

---

## USB HID Keyboard

When the scanner is connected to the USB port on a host device, you can enable the USB HID Keyboard feature by scanning the barcode below. Then scanner's transmission will be simulated as USB keyboard input. The Host receives keystrokes on the virtual keyboard. It works on a Plug and Play basis and no driver is required.



@INTERF3  
**\*\* USB HID Keyboard**



If the host device allows keyboard input, then no extra software is needed for HID Keyboard input.



@SETUPE0  
**\*\* Exit Setup**



@SETUPE1  
**Enter Setup**

---

## USB Country Keyboard Types

Keyboard layouts vary from country to country. The default setting is U.S. keyboard.



@KBWCTY0  
**\*\* U.S. (English)**



@KBWCTY1  
**Belgium**



@KBWCTY2  
**Brazil**



@KBWCTY3  
**Canada (French)**



@KBWCTY4  
**Czechoslovakia**



@KBWCTY5  
**Denmark**



@KBWCTY6  
**Finland (Swedish)**

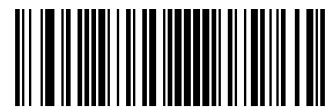

@SETUPE0  
**\*\* Exit Setup**



@SETUPE1  
**Enter Setup**

---



@KBWCTY8  
**Germany/ Austria**

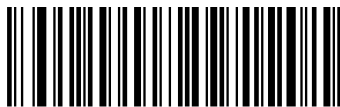

@KBWCTY10  
**Hungary**

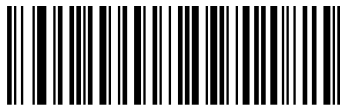

@KBWCTY12  
**Italy**

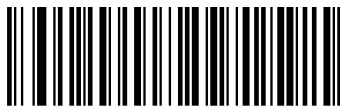

@KBWCTY14  
**Netherlands (Dutch)**



@KBWCTY7  
**France**



@KBWCTY9  
**Greece**



@KBWCTY11  
**Israel (Hebrew)**



@KBWCTY13  
**Latin America/ South America**



@SETUPE0  
**\*\* Exit Setup**



@SETUPE1  
**Enter Setup**

---



@KBWCTY15  
**Norway**



@KBWCTY16  
**Poland**



@KBWCTY17  
**Portugal**



@KBWCTY18  
**Romania**



@KBWCTY19  
**Russia**



@KBWCTY21  
**Slovakia**



@KBWCTY22  
**Spain**



@KBWCTY23  
**Sweden**



@SETUPE0  
**\*\* Exit Setup**



@SETUPE1  
**Enter Setup**

---



@KBWCTY24  
**Switzerland (German)**



@KBWCTY25  
**Turkey\_F**



@KBWCTY26  
**Turkey\_Q**



@KBWCTY27  
**UK**



@KBWCTY28  
**Japan**



@SETUPE0  
**\*\* Exit Setup**



@SETUPE1  
Enter Setup

### Beep on Unknown Character

Due to the differences in keyboard layouts, some characters contained in barcode data may be unavailable on the selected keyboard. As a result, the scanner fails to transmit the unknown characters.

Scan the appropriate barcode below to enable or disable the emission of beep when an unknown character is detected.



@KBWBUC0

**\*\* Do Not Beep on Unknown Character**



@KBWBUC1

**Beep on Unknown Character**

## E *sample*

Supposing French keyboard (Country Code: 7) is selected and barcode data "ADF" is being dealt with, the keyboard will fail to locate the "D" (0xD0) character and the scanner will ignore the character and continue to process the next one.

**Do Not Beep on Unknown Character:** The scanner does not beep and the Host receives "AF".

**Beep on Unknown Character:** The scanner beeps and the Host still receives "AF".



If **Emulate ALT+Keypad ON** is selected, **Beep on Unknown Character** does not function.

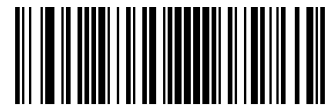

@SETUPE0  
**\*\* Exit Setup**



@SETUPE1  
Enter Setup

---

## Emulate ALT+Keypad

When **Emulate ALT+Keypad** is turned on, any character whose ASCII value is greater than or equal to 0x20 is sent over the numeric keypad no matter which keyboard type is selected.

1. ALT Make
2. Enter the number corresponding to a desired character on the keypad.
3. ALT Break

After **Emulate ALT+Keypad ON** is selected, you need to choose the code page with which the barcodes were created and to turn **Unicode Encoding** On or Off depending on the encoding used by the application software.



@KBWALTO  
**\*\* Emulate ALT+Keypad OFF**



**Emulate ALT+Keypad ON**



Since sending a character involves multiple keystroke emulations, this method appears less efficient.

**E**  
*xample*

Supposing **Emulate ALT+Keypad** is ON, **Unicode Encoding** is Off, **Code Page 1252 (West European Latin)** is selected, and **Emulate Keypad with Leading Zero** is Off, barcode data "ADF" (65/208/70) is sent as below:

"A" -- "ALT Make" + "065" + "ALT Break"

"D" -- "ALT Make" + "208" + "ALT Break"

"F" -- "ALT Make" + "070" + "ALT Break"



@SETUPE0  
**\*\* Exit Setup**





@SETUPE1  
Enter Setup

### Code Page

Code pages define the mapping of character codes to characters. If the data received does not display with the proper characters, it may be because the barcode being scanned was created using a code page that is different from the one the host program is expecting. If this is the case, select the code page with which the barcodes were created by scanning the appropriate barcode below. For PDF417, QR Code, Aztec and Data Matrix, besides setting the code page, you also need to set the character encoding in the “Character Encoding” section in Chapter 6. This feature is only effective when **Emulate ALT+Keypad** is turned on.



@KBWCPG0

**\*\* Code Page 1252 (West European Latin)**



@KBWCPG1

**Code Page 1251 (Cyrillic)**



@KBWCPG2

**Code Page 1250 (Central and East European Latin)**



@KBWCPG3

**Code Page 1253 (Greek)**



@KBWCPG4

**Code Page 1254 (Turkish)**



@KBWCPG5

**Code Page 1255 (Hebrew)**



@SETUPE0

**\*\* Exit Setup**



@SETUPE1  
**Enter Setup**

---



@KBWCPG6  
**Code Page 1256 (Arabic)**



@KBWCPG8  
**Code Page 1258 (Vietnamese)**



@KBWCPG10  
**Code Page 950 (Traditional Chinese, Big5)**



@KBWCPG7  
**Code Page 1257 (Baltic)**



@KBWCPG9  
**Code Page 936 (Simplified Chinese, GB2312,GBK)**



@KBWCPG12  
**Code Page 932 (Japanese, Shift-JIS)**



@SETUPE0  
**\*\* Exit Setup**



@SETUPE1  
**Enter Setup**

---

### Unicode Encoding

Different host program may use different character encodings for handling incoming barcode data. For instance, Microsoft Office Word uses Unicode encoding and therefore you should turn **Unicode Encoding** on, whereas Microsoft Office Excel or Notepad uses Code Page encoding and therefore you should turn **Unicode Encoding** off. This feature is only effective when **Emulate ALT+Keypad** is turned on.



@KBWCPU0  
**\*\* Off**



@KBWCPU1  
**On**

### Emulate Keypad with Leading Zero

You may turn this feature on to send character sequences sent over the numeric keypad as ISO characters which have a leading zero. For example, ASCII A transmits as "ALT MAKE" 0065 "ALT BREAK". This feature is only effective when **Emulate ALT+Keypad** is enabled.



@KBWALZ1  
**\*\* On**



@KBWALZ0  
**Off**

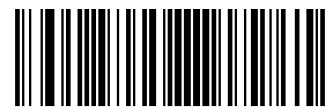

@SETUPE0  
**\*\* Exit Setup**



@SETUPE1  
Enter Setup

---

## Function Key Mapping

When **Ctrl+ASCII Mode** is selected, function characters (0x00 - 0x1F) are sent as ASCII sequences.



@KBWFKM0  
**\*\* Disable**



@KBWFKM1  
**Ctrl+ASCII Mode**



@KBWFKM2  
**Alt+Keypad Mode**

## Example

If **Ctrl+ASCII Mode** is selected and other parameters of USB HID Keyboard adopt factory defaults, barcode data “A<HT>(i.e. Horizontal Tab)F” (0x41/0x09/0x46) is sent as below:

“A” - Keystroke “A”

<HT> - “Ctrl Make” + Keystroke “I” + “Ctrl Break”

“F” - Keystroke “F”

For some text editors, “Ctrl I” means italic convert. So the output may be “*A*F”.

If **Alt+Keypad Mode** is selected and other parameters of USB HID Keyboard adopt factory defaults, the data above is sent as below:

“A” - Keystroke “A”

<HT> - “Alt Make” + Keystrokes “009” + “Alt Break”

“F” - Keystroke “F”



@SETUPE0  
**\*\* Exit Setup**



@SETUPE1  
Enter Setup

### ASCII Function Key Mapping Table

ASCII Function	ASCII Value (HEX)	Function Key Mapping Disabled	Ctrl+ASCII
NUL	00	Null	Ctrl+@
SOH	01	Keypad Enter	Ctrl+A
STX	02	Caps Lock	Ctrl+B
ETX	03	ALT	Ctrl+C
EOT	04	Null	Ctrl+D
ENQ	05	CTRL	Ctrl+E
ACK	06	Null	Ctrl+F
BEL	07	Enter	Ctrl+G
BS	08	Left Arrow	Ctrl+H
HT	09	Horizontal Tab	Ctrl+I
LF	0A	Down Arrow	Ctrl+J
VT	0B	Vertical Tab	Ctrl+K
FF	0C	Delete	Ctrl+L
CR	0D	Enter	Ctrl+M
SO	0E	Insert	Ctrl+N
SI	0F	Esc	Ctrl+O
DLE	10	F11	Ctrl+P
DC1	11	Home	Ctrl+Q
DC2	12	PrintScreen	Ctrl+R
DC3	13	Backspace	Ctrl+S
DC4	14	tab+shift	Ctrl+T
NAK	15	F12	Ctrl+U
SYN	16	F1	Ctrl+V
ETB	17	F2	Ctrl+W
CAN	18	F3	Ctrl+X
EM	19	F4	Ctrl+Y
SUB	1A	F5	Ctrl+Z
ESC	11	F6	Ctrl+[
FS	1C	F7	Ctrl+\
GS	1D	F8	Ctrl+]
RS	1E	F9	Ctrl+6
US	1F	F10	Ctrl+-



@SETUPE0  
\*\* Exit Setup



@SETUPE1  
Enter Setup

### ASCII Function Key Mapping Table (Continued)

The last five characters (0x1B~0x1F) in the table above apply to US keyboard layout only. The following chart provides the equivalents of these five characters for other countries.

Country	Ctrl+ASCII					
United States	Ctrl+[	Ctrl+\	Ctrl+]	Ctrl+6	Ctrl+-	
Belgium	Ctrl+[	Ctrl+<	Ctrl+]	Ctrl+6	Ctrl+-	
Scandinavia	Ctrl+8	Ctrl+<	Ctrl+9	Ctrl+6	Ctrl+-	
France	Ctrl+^	Ctrl+8	Ctrl+\$	Ctrl+6	Ctrl+=	
Germany		Ctrl+Ã	Ctrl++	Ctrl+6	Ctrl+-	
Italy		Ctrl+\	Ctrl++	Ctrl+6	Ctrl+-	
Switzerland		Ctrl+<	Ctrl+..	Ctrl+6	Ctrl+-	
United Kingdom	Ctrl+[	Ctrl+∅	Ctrl+]	Ctrl+6	Ctrl+-	
Denmark	Ctrl+8	Ctrl+\	Ctrl+9	Ctrl+6	Ctrl+-	
Norway	Ctrl+8	Ctrl+\	Ctrl+9	Ctrl+6	Ctrl+-	
Spain	Ctrl+[	Ctrl+\	Ctrl+]	Ctrl+6	Ctrl+-	



@SETUPE0  
\*\* Exit Setup



@SETUPE1  
**Enter Setup**

---

## Inter-Keystroke Delay

This parameter specifies the delay between emulated keystrokes.



@KBWDLY0  
**\*\* No Delay**



@KBWDLY40  
**Long Delay (40ms)**

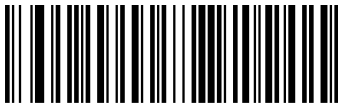

@KBWDLY20  
**Short Delay (20ms)**

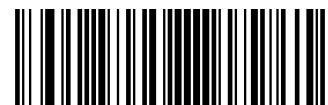

@SETUPE0  
**\*\* Exit Setup**



@SETUPE1  
Enter Setup

## Caps Lock

The **Caps Lock On** options can invert upper and lower case characters contained in barcode data. This inversion occurs regardless of the state of Caps Lock key on the host device's keyboard. To disable this feature, scan the appropriate **Caps Lock OFF** barcode below based on your keyboard.



@KBWCAP0

\*\* Caps Lock OFF, Non-Japanese Keyboard



@KBWCAP1

Caps Lock ON, Non-Japanese Keyboard



@KBWCAP2

Caps Lock OFF, Japanese Keyboard



@KBWCAP3

Caps Lock ON, Japanese Keyboard



Emulate ALT+Keypad ON/ Convert All to Upper Case/ Convert All to Lower Case prevails over Caps Lock ON.



When the **Caps Lock ON** feature is selected, barcode data "AbC" is transmitted as "aBc".



@SETUPE0  
\*\* Exit Setup





@SETUPE1  
**Enter Setup**

---

## Convert Case

Scan the appropriate barcode below to convert all bar code data to your desired case.



@KBWCAS0  
**\*\* No Case Conversion**



@KBWCAS1  
**Convert All to Upper Case**



@KBWCAS2  
**Convert All to Lower Case**

**E**  
*xample*

When the **Convert All to Lower Case** feature is enabled, barcode data “AbC” is transmitted as “abc”.



If **Emulate ALT+Keypad ON** is selected, **Convert All to Lower Case** and **Convert All to Upper Case** do not function.



@SETUPE0  
**\*\* Exit Setup**



@SETUPE1  
Enter Setup

## Emulate Numeric Keypad



- ◇ **Do Not Emulate Numeric Keypad 1:** Sending a number (0-9) is emulated as keystroke(s) on main keyboard.
- ◇ **Emulate Numeric Keypad 1:** Sending a number (0-9) is emulated as keystroke(s) on numeric keypad. The state of Num Lock on the simulated numeric keypad is determined by its equivalent on the host device. If Num Lock on the host device is turned off, the output of simulated numeric keypad is function key instead of number.
- ◇ **Do Not Emulate Numeric Keypad 2:** Sending “+”, “-”, “\*” and “/” is emulated as keystroke(s) on main keyboard.
- ◇ **Emulate Numeric Keypad 2:** Sending “+”, “-”, “\*” and “/” is emulated as keystroke(s) on numeric keypad.



@KBWNUM0

**\*\* Do Not Emulate Numeric Keypad 1**



@KBWNUM1

**Emulate Numeric Keypad 1**



@SETUPE0  
**\*\* Exit Setup**



@SETUPE1  
**Enter Setup**

---



@KBWNCH0

**\*\* Do Not Emulate Numeric Keypad 2**



@KBWNCH1

**Emulate Numeric Keypad 2**



**Emulate ALT+Keypad ON** prevails over **Emulate Numeric Keypad**.

**E**  
*example*

Supposing the **Emulate Numeric Keypad 1** feature is enabled:

if Num Lock on the host device is ON, "A4.5" is transmitted as "A4.5";

if Num Lock on the host device is OFF, "A4.5" is transmitted as ".A":

1. "A" is sent on main keyboard;
2. "4" is sent as the function key "Cursor Move to Left";
3. "." is sent on main keyboard;
4. "5" is not sent as it does not correspond to any function key.

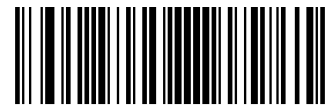

@SETUPE0  
**\*\* Exit Setup**



@SETUPE1  
**Enter Setup**

---

## Fast Mode

When **Fast Mode On** is selected, the scanner sends characters to the Host faster. If the Host drops characters, turn the Fast Mode off or change the polling rate to a bigger value.



@KBWFAS0  
**\*\* Fast Mode Off**



@KBWFAS1  
**Fast Mode On**



@SETUPE0  
**\*\* Exit Setup**



@SETUPE1  
**Enter Setup**

---

## Polling Rate

This parameter specifies the polling rate for a USB keyboard. If the Host drops characters, change the polling rate to a bigger value.



@KBWPOR0  
**1ms**



@KBWPOR1  
**2ms**



@KBWPOR2  
**3ms**



@KBWPOR3  
**\*\* 4ms**



@KBWPOR4  
**5ms**



@KBWPOR5  
**6ms**



@KBWPOR6  
**7ms**

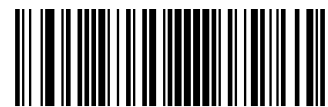

@SETUPE0  
**\*\* Exit Setup**



@SETUPE1  
**Enter Setup**

---



@KBWPOR7  
**8ms**



@KBWPOR8  
**9ms**



@KBWPOR9  
**10ms**



@SETUPE0  
**\*\* Exit Setup**



@SETUPE1  
**Enter Setup**

---

## USB CDC

If your scanner is connected to the USB port on a host device, the USB CDC feature allows the host device to receive data in the way as a serial port does. A driver is needed when using this feature. You may download it from our website at [www.newlandaidc.com](http://www.newlandaidc.com).



@INTERF8  
**USB CDC**

## HID POS (POS HID Barcode Scanner)

### Introduction

The HID-POS interface is recommended for new application programs. It can send up to 56 characters in a single USB report and appears more efficient than keyboard emulation.

Features:

- ✧ HID based, no custom driver required.
- ✧ Way more efficient in communication than keyboard emulation and traditional RS-232 interface.



@INTERF5  
**USB HID-POS**

### Access the Scanner with Your Program

Use CreateFile to access the scanner as a HID device and then use ReadFile to deliver the scanned data to the application program. Use WriteFile to send data to the scanner.

For detailed information about USB and HID interfaces, go to [www.USB.org](http://www.USB.org).

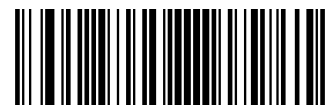

@SETUPE0  
**\*\* Exit Setup**



@SETUPE1  
Enter Setup

### Acquire Scanned Data

After a barcode is decoded, the scanner sends an input report as below:

	Bit							
Byte	7	6	5	4	3	2	1	0
0	Report ID = 0x02							
1	Barcode Length							
2-57	Decoded Data (1-56)							
58-61	Reserved							
62	Newland Symbology Identifier or N/C: 0x00							
63	-	-	-	-	-	-	-	Decoded data continued

### Send Command to the Scanner

This output report is used to send commands to the scanner. All programming commands can be used.

	Bit							
Byte	7	6	5	4	3	2	1	0
0	Report ID = 0x04							
1	Length of command							
2-63	Command (1-62)							



@SETUPE0  
\*\* Exit Setup





@SETUPE1  
Enter Setup

## IBM SurePOS (Tabletop)



@INTERF6

IBM SurePOS (Tabletop)

## IBM SurePOS (Handheld)



@INTERF7

IBM SurePOS (Handheld)

## VID/PID

USB uses VID (Vendor ID) and PID (Product ID) to identify and locate a device. The VID is assigned by USB Implementers Forum. Newland's vendor ID is 1EAB (Hex). A range of PIDs are used for each Newland product family. Every PID contains a base number and interface type (keyboard, COM port, etc.).

Product	Interface	PID (Hex)	PID (Dec)
FR80	USB HID Keyboard	3522	13602
	USB CDC	3506	13574
	HID POS	3510	13584
	IBM SurePOS (Tabletop)	3520	13600
	IBM SurePOS(Handheld)	3521	13601



@SETUPE0  
\*\* Exit Setup



@SETUPE1  
**Enter Setup**

---

## Adaptive Wired Communication

When this feature is on, the scanner can automatically adapt its communication configuration to the way it is connected to the host device: Automatically enable USB/serial communication when connected to the host device via USB/serial port, respectively.

Note: You must restart the scanner before this setting will take effect.

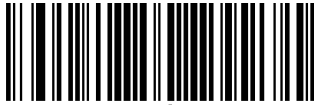

@AUTOUR0  
**Off**



@AUTOUR1  
**\*\* On**



@SETUPE0  
**\*\* Exit Setup**



@SETUPE1  
Enter Setup

# Chapter 9 Symbologies

## Introduction

Every symbology (barcode type) has its own unique attributes. This chapter provides programming barcodes for configuring the scanner so that it can identify various symbologies. It is recommended to disable those that are rarely used to increase the efficiency of the scanner.

## Global Settings

### Enable/Disable All Symbologies

If the **Disable All Symbologies** feature is enabled, the scanner will not be able to read any non-programming barcodes except the programming barcodes.



@ALLENA1  
Enable All Symbologies



@ALLENA0  
Disable All Symbologies

### Enable/Disable 1D Symbologies



@ALL1DC1  
Enable 1D Symbologies



@ALL1DC0  
Disable 1D Symbologies



@SETUPE0  
\*\* Exit Setup



@SETUPE1  
Enter Setup

---

### Enable/Disable 2D Symbologies



@ALL2DC1  
Enable 2D Symbologies



@ALL2DC0  
Disable 2D Symbologies

### Enable/Disable Postal Symbologies



@ALLPST1  
Enable All Postal Symbologies



@ALLPST0  
Disable All Postal Symbologies



@SETUPE0  
\*\* Exit Setup



@SETUPE1  
**Enter Setup**

---

## 1D Twin Code

1D twin code is two 1D barcodes of a symbology or of different symbologies paralleled vertically. Both barcodes must have similar specifications and be placed closely together.

There are 3 options for reading 1D twin code:

- ◇ **Single 1D Code Only:** Read either 1D code.
- ◇ **Twin 1D Code Only:** Read both 1D codes. Transmission sequence: upper 1D code followed by lower 1D code.
- ◇ **Both Single & Twin:** Read both 1D codes. If successful, transmit as twin 1D code only. Otherwise, try single 1D code only.



@A1DDOU0  
**\*\* Single 1D Code Only**



@A1DDOU2  
**Twin 1D Code Only**



@A1DDOU1  
**Both Single & Twin**

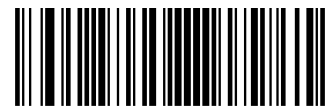

@SETUPE0  
**\*\* Exit Setup**



@SETUPE1  
Enter Setup

---

## Code 128

### Restore Factory Defaults



@128DEF  
Restore the Factory Defaults of Code 128

### Enable/Disable Code 128



@128ENA1  
\*\* Enable Code 128



@128ENA0  
Disable Code 128



If the scanner fails to identify Code 128 barcodes, you may first try this solution by scanning the **Enter Setup** barcode and then **Enable Code 128** barcode.



@SETUPE0  
\*\* Exit Setup



@SETUPE1  
**Enter Setup**

## Set Length Range for Code 128

The scanner can be configured to only decode Code 128 barcodes with lengths that fall between (inclusive) the minimum and maximum lengths. To accomplish it, you need to set the minimum and maximum lengths.



@128MIN

**Set the Minimum Length (Default: 1)**



@128MAX

**Set the Maximum Length (Default: 48)**



If minimum length is set to be greater than maximum length, the scanner only decodes Code 128 barcodes with either the minimum or maximum length. If minimum length is same as maximum length, only Code 128 barcodes with that length are to be decoded.



**Set the scanner to decode Code 128 barcodes containing between 8 and 12 characters:**

1. Scan the **Enter Setup** barcode.
2. Scan the **Set the Minimum Length** barcode.
3. Scan the numeric barcode "8" from the "Digit Barcodes" section in Appendix.
4. Scan the **Save** barcode from the "Save/Cancel Barcodes" section in Appendix.
5. Scan the **Set the Maximum Length** barcode.
6. Scan the numeric barcodes "1" and "2" from the "Digit Barcodes" section in Appendix.
7. Scan the **Save** barcode from the "Save/Cancel Barcodes" section in Appendix.
8. Scan the **Exit Setup** barcode.



@SETUPE0  
**\*\* Exit Setup**



@SETUPE1  
Enter Setup

## EAN-8

### Restore Factory Defaults



@EA8DEF  
Restore the Factory Defaults of EAN-8

### Enable/Disable EAN-8



@EA8ENA1  
\*\* Enable EAN-8



@EA8ENA0  
Disable EAN-8



If the scanner fails to identify EAN-8 barcodes, you may first try this solution by scanning the **Enter Setup** barcode and then **Enable EAN-8** barcode.

### Transmit Check Character

EAN-8 is 8 digits in length with the last one as its check character used to verify the integrity of the data.



@EA8CHK2  
\*\* Transmit EAN-8 Check Character



@EA8CHK1  
Do Not Transmit EAN-8 Check Character



@SETUPE0  
\*\* Exit Setup





@SETUPE1

Enter Setup

## 2-Digit Add-On Code

An EAN-8 barcode can be augmented with a two-digit add-on code to form a new one. In the example below, the part surrounded by blue dotted line is an EAN-8 barcode while the part circled by red dotted line is a two-digit add-on code.



@EA8AD20

**\*\* Disable 2-Digit Add-On Code**



@EA8AD21

**Enable 2-Digit Add-On Code**



**Disable 2-Digit Add-On Code:** The scanner decodes EAN-8 and ignores the add-on code when presented with an EAN-8 plus 2-digit add-on barcode. It can also decode EAN-8 barcodes without 2-digit add-on codes.

**Enable 2-Digit Add-On Code:** The scanner decodes a mix of EAN-8 barcodes with and without 2-digit add-on codes.

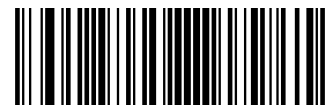

@SETUPE0

**\*\* Exit Setup**



@SETUPE1  
Enter Setup

---

### 5-Digit Add-On Code

An EAN-8 barcode can be augmented with a five-digit add-on code to form a new one. In the example below, the part surrounded by blue dotted line is an EAN-8 barcode while the part circled by red dotted line is a five-digit add-on code.



**\*\* Disable 5-Digit Add-On Code**



**Enable 5-Digit Add-On Code**



**Disable 5-Digit Add-On Code:** The scanner decodes EAN-8 and ignores the add-on code when presented with an EAN-8 plus 5-digit add-on barcode. It can also decode EAN-8 barcodes without 5-digit add-on codes.

**Enable 5-Digit Add-On Code:** The scanner decodes a mix of EAN-8 barcodes with and without 5-digit add-on codes.



@SETUPE0  
**\*\* Exit Setup**



@SETUPE1  
Enter Setup

### Add-On Code Required

When **EAN-8 Add-On Code Required** is selected, the scanner will only read EAN-8 barcodes that contain add-on codes.

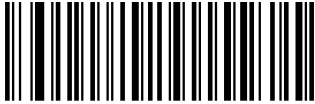

@EA8REQ0

**\*\* EAN-8 Add-On Code Not Required**



@EA8REQ1

**EAN-8 Add-On Code Required**

### Convert EAN-8 to EAN-13

**Convert EAN-8 to EAN-13:** Convert EAN-8 decoded data to EAN-13 format before transmission. After conversion, the data follows EAN-13 format and is affected by EAN-13 programming selections (e.g., Check Character).

**Do Not Convert EAN-8 to EAN-13:** EAN-8 decoded data is transmitted as EAN-8 data, without conversion.



@EA8EXP0

**\*\* Do Not Convert EAN-8 to EAN-13**



@EA8EXP1

**Convert EAN-8 to EAN-13**

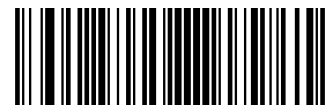

@SETUPE0  
**\*\* Exit Setup**



@SETUPE1  
Enter Setup

---

## EAN-13

### Restore Factory Defaults



@E13DEF  
Restore the Factory Defaults of EAN-13

### Enable/Disable EAN-13



@E13ENA1  
\*\* Enable EAN-13



@E13ENA0  
Disable EAN-13



If the scanner fails to identify EAN-13 barcodes, you may first try this solution by scanning the **Enter Setup** barcode and then **Enable EAN-13** barcode.



@SETUPE0  
\*\* Exit Setup



@SETUPE1  
Enter Setup

### Transmit Check Character



@E13CHK2

**\*\* Transmit EAN-13 Check Character**



@E13CHK1

**Do Not Transmit EAN-13 Check Character**

### 2-Digit Add-On Code

An EAN-13 barcode can be augmented with a two-digit add-on code to form a new one. In the example below, the part surrounded by blue dotted line is an EAN-13 barcode while the part circled by red dotted line is a two-digit add-on code.



@E13AD20

**\*\* Disable 2-Digit Add-On Code**



@E13AD21

**Enable 2-Digit Add-On Code**



**Disable 2-Digit Add-On Code:** The scanner decodes EAN-13 and ignores the add-on code when presented with an EAN-13 plus 2-digit add-on barcode. It can also decode EAN-13 barcodes without 2-digit add-on codes.

**Enable 2-Digit Add-On Code:** The scanner decodes a mix of EAN-13 barcodes with and without 2-digit add-on codes.

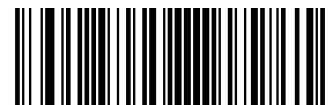

@SETUPE0

**\*\* Exit Setup**



@SETUPE1  
Enter Setup

### 5-Digit Add-On Code

An EAN-13 barcode can be augmented with a five-digit add-on code to form a new one. In the example below, the part surrounded by blue dotted line is an EAN-13 barcode while the part circled by red dotted line is a five-digit add-on code.



**\*\* Disable 5-Digit Add-On Code**



**Enable 5-Digit Add-On Code**



**Disable 5-Digit Add-On Code:** The scanner decodes EAN-13 and ignores the add-on code when presented with an EAN-13 plus 5-digit add-on barcode. It can also decode EAN-13 barcodes without 5-digit add-on codes.

**Enable 5-Digit Add-On Code:** The scanner decodes a mix of EAN-13 barcodes with and without 5-digit add-on codes.

### Add-On Code Required

When **EAN-13 Add-On Code Required** is selected, the scanner will only read EAN-13 barcodes that contain add-on codes.



**\*\* EAN-13 Add-On Code Not Required**



**EAN-13 Add-On Code Required**



@SETUPE0  
**\*\* Exit Setup**



@SETUPE1  
Enter Setup

### EAN-13 Beginning with 290 Add-On Code Required

This setting programs the scanner to require an add-on code (2-digit or 5-digit) on EAN-13 barcodes that begin with “290”. The following settings can be programmed:

**Require Add-On Code:** All EAN-13 barcodes that begin with “290” must have a 2-digit or 5-digit add-on code. The EAN-13 barcode with the add-on code is then transmitted. If the required add-on code is not found, the EAN-13 barcode is discarded.

**Do Not Require Add-On Code:** If you have selected **Require Add-On Code**, and you want to disable this feature, scan **Do Not Require Add-On Code**. EAN-13 barcodes are handled, depending on your selection for the “Add-On Code Required” feature.



\*\* Do Not Require Add-On Code



Require Add-On Code

### EAN-13 Beginning with 378/379 Add-On Code Required

This setting programs the scanner to require an add-on code (2-digit or 5-digit) on EAN-13 barcodes that begin with a “378” or “379”. The following settings can be programmed:

**Require Add-On Code:** All EAN-13 barcodes that begin with a “378” or “379” must have a 2-digit or 5-digit add-on code. The EAN-13 barcode with the add-on code is then transmitted. If the required add-on code is not found, the EAN-13 barcode is discarded.

**Do Not Require Add-On Code:** If you have selected **Require Add-On Code**, and you want to disable this feature, scan **Do Not Require Add-On Code**. EAN-13 barcodes are handled, depending on your selection for the “Add-On Code Required” feature.



\*\* Do Not Require Add-On Code



Require Add-On Code



@SETUPE0  
\*\* Exit Setup



@SETUPE1  
Enter Setup

### EAN-13 Beginning with 414/419 Add-On Code Required

This setting programs the scanner to require an add-on code (2-digit or 5-digit) on EAN-13 barcodes that begin with a “414” or “419”. The following settings can be programmed:

**Require Add-On Code:** All EAN-13 barcodes that begin with a “414” or “419” must have a 2-digit or 5-digit add-on code. The EAN-13 barcode with the add-on code is then transmitted. If the required add-on code is not found, the EAN-13 barcode is discarded.

**Do Not Require Add-On Code:** If you have selected **Require Add-On Code**, and you want to disable this feature, scan **Do Not Require Add-On Code**. EAN-13 barcodes are handled, depending on your selection for the “Add-On Code Required” feature.



@E134140

**\*\* Do Not Require Add-On Code**



@E134141

**Require Add-On Code**

### EAN-13 Beginning with 434/439 Add-On Code Required

This setting programs the scanner to require an add-on code (2-digit or 5-digit) on EAN-13 barcodes that begin with a “434” or “439”. The following settings can be programmed:

**Require Add-On Code:** All EAN-13 barcodes that begin with a “434” or “439” must have a 2-digit or 5-digit add-on code. The EAN-13 barcode with the add-on code is then transmitted. If the required add-on code is not found, the EAN-13 barcode is discarded.

**Do Not Require Add-On Code:** If you have selected **Require Add-On Code**, and you want to disable this feature, scan **Do Not Require Add-On Code**. EAN-13 barcodes are handled, depending on your selection for the “Add-On Code Required” feature.



@E134340

**\*\* Do Not Require Add-On Code**



@E134341

**Require Add-On Code**



@SETUPE0  
**\*\* Exit Setup**





@SETUPE1  
Enter Setup

### EAN-13 Beginning with 977 Add-On Code Required

This setting programs the scanner to require an add-on code (2-digit or 5-digit) on EAN-13 barcodes that begin with “977”. The following settings can be programmed:

**Require Add-On Code:** All EAN-13 barcodes that begin with “977” must have a 2-digit or 5-digit add-on code. The EAN-13 barcode with the add-on code is then transmitted. If the required add-on code is not found, the EAN-13 barcode is discarded.

**Do Not Require Add-On Code:** If you have selected **Require Add-On Code**, and you want to disable this feature, scan **Do Not Require Add-On Code**. EAN-13 barcodes are handled, depending on your selection for the “Add-On Code Required” feature.



\*\* Do Not Require Add-On Code



Require Add-On Code

### EAN-13 Beginning with 978 Add-On Code Required

This setting programs the scanner to require an add-on code (2-digit or 5-digit) on EAN-13 barcodes that begin with “978”. The following settings can be programmed:

**Require Add-On Code:** All EAN-13 barcodes that begin with “978” must have a 2-digit or 5-digit add-on code. The EAN-13 barcode with the add-on code is then transmitted. If the required add-on code is not found, the EAN-13 barcode is discarded.

**Do Not Require Add-On Code:** If you have selected **Require Add-On Code**, and you want to disable this feature, scan **Do Not Require Add-On Code**. EAN-13 barcodes are handled, depending on your selection for the “Add-On Code Required” feature.



\*\* Do Not Require Add-On Code



Require Add-On Code



@SETUPE0  
\*\* Exit Setup



@SETUPE1  
Enter Setup

---

### EAN-13 Beginning with 979 Add-On Code Required

This setting programs the scanner to require an add-on code (2-digit or 5-digit) on EAN-13 barcodes that begin with “979”. The following settings can be programmed:

**Require Add-On Code:** All EAN-13 barcodes that begin with “979” must have a 2-digit or 5-digit add-on code. The EAN-13 barcode with the add-on code is then transmitted. If the required add-on code is not found, the EAN-13 barcode is discarded.

**Do Not Require Add-On Code:** If you have selected **Require Add-On Code**, and you want to disable this feature, scan **Do Not Require Add-On Code**. EAN-13 barcodes are handled, depending on your selection for the “Add-On Code Required” feature.



@E139790

**\*\* Do Not Require Add-On Code**



@E139791

**Require Add-On Code**



@SETUPE0

**\*\* Exit Setup**



@SETUPE1  
Enter Setup

## UPC-E

### Restore Factory Defaults



@UPEDEF

Restore the Factory Defaults of UPC-E

### Transmit Check Character

UPC-E is 8 digits in length with the last one as its check character used to verify the integrity of the data.



@UPECHK2

\*\* Transmit UPC-E Check Character

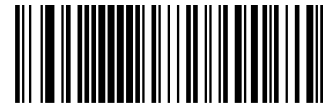

@UPECHK1

Do Not Transmit UPC-E Check Character

### 2-Digit Add-On Code

A UPC-E barcode can be augmented with a two-digit add-on code to form a new one. In the example below, the part surrounded by blue dotted line is a UPC-E barcode while the part circled by red dotted line is a two-digit add-on code.

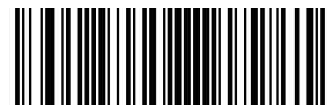

@SETUPE0  
\*\* Exit Setup



@SETUPE1  
Enter Setup



@UPEAD20  
**\*\* Disable 2-Digit Add-On Code**



@UPEAD21  
**Enable 2-Digit Add-On Code**



**Disable 2-Digit Add-On Code:** The scanner decodes UPC-E and ignores the add-on code when presented with a UPC-E plus 2-digit add-on barcode. It can also decode UPC-E barcodes without 2-digit add-on codes.

**Enable 2-Digit Add-On Code:** The scanner decodes a mix of UPC-E barcodes with and without 2-digit add-on codes.

### 5-Digit Add-On Code

A UPC-E barcode can be augmented with a five-digit add-on code to form a new one. In the example below, the part surrounded by blue dotted line is a UPC-E barcode while the part circled by red dotted line is a five-digit add-on code.



@UPEAD50  
**\*\* Disable 5-Digit Add-On Code**



@UPEAD51  
**Enable 5-Digit Add-On Code**



**Disable 5-Digit Add-On Code:** The scanner decodes UPC-E and ignores the add-on code when presented with a UPC-E plus 5-digit add-on barcode. It can also decode UPC-E barcodes without 5-digit add-on codes.

**Enable 5-Digit Add-On Code:** The scanner decodes a mix of UPC-E barcodes with and without 5-digit add-on codes.



@SETUPE0  
**\*\* Exit Setup**



@SETUPE1  
**Enter Setup**

### Add-On Code Required

When **UPC-E Add-On Code Required** is selected, the scanner will only read UPC-E barcodes that contain add-on codes.



@UPEREQ0

**\*\* UPC-E Add-On Code Not Required**



@UPEREQ1

**UPC-E Add-On Code Required**

### Transmit Preamble Character

Preamble characters (Country Code and System Character) can be transmitted as part of a UPC-E barcode. Select one of the following options for transmitting UPC-E preamble to the host device: transmit system character only, transmit system character and country code ("0" for USA), or transmit no preamble.



@UPEPRE1

**\*\* System Character**



@UPEPRE0

**No Preamble**

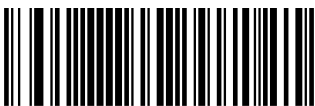

@UPEPRE2

**System Character & Country Code**

### Convert UPC-E to UPC-A

**Convert UPC-E to UPC-A:** Convert UPC-E (zero suppressed) decoded data to UPC-A format before transmission. After

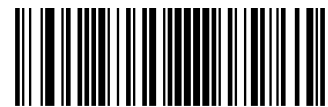

@SETUPE0

**\*\* Exit Setup**



@SETUPE1

**Enter Setup**

conversion, the data follows UPC-A format and is affected by UPC-A programming selections (e.g., Preamble, Check Character).

**Do Not Convert UPC-E to UPC-A:** UPC-E decoded data is transmitted as UPC-E data, without conversion.



@UPEEXP0

**\*\* Do Not Convert UPC-E to UPC-A**



@UPEEXP1

**Convert UPC-E to UPC-A**

## UPC-A

**Restore Factory Defaults**



@UPADEF

**Restore the Factory Defaults of UPC-A**

**Enable/Disable UPC-A**



@UPAENA1

**\*\* Enable UPC-A**



@UPAENA0

**Disable UPC-A**



If the scanner fails to identify UPC-A barcodes, you may first try this solution by scanning the **Enter Setup** barcode and then **Enable UPC-A** barcode.



@SETUPE0

**\*\* Exit Setup**



@SETUPE1

Enter Setup

### Transmit Check Character

UPC-A is 13 digits in length with the last one as its check character used to verify the integrity of the data.



@UPACHK2

**\*\* Transmit UPC-A Check Character**



@UPACHK1

**Do Not Transmit UPC-A Check Character**

### 2-Digit Add-On Code

A UPC-A barcode can be augmented with a two-digit add-on code to form a new one. In the example below, the part surrounded by blue dotted line is a UPC-A barcode while the part circled by red dotted line is a two-digit add-on code.



@UPAAD20

**\*\* Disable 2-Digit Add-On Code**



@UPAAD21

**Enable 2-Digit Add-On Code**



@SETUPE0

**\*\* Exit Setup**



@SETUPE1

### Enter Setup

---



**Disable 2-Digit Add-On Code:** The scanner decodes UPC-A and ignores the add-on code when presented with a UPC-A plus 2-digit add-on barcode. It can also decode UPC-A barcodes without 2-digit add-on codes.

**Enable 2-Digit Add-On Code:** The scanner decodes a mix of UPC-A barcodes with and without 2-digit add-on codes.



@SETUPE0

\*\* Exit Setup





@SETUPE1  
Enter Setup

### 5-Digit Add-On Code

A UPC-A barcode can be augmented with a five-digit add-on code to form a new one. In the example below, the part surrounded by blue dotted line is a UPC-A barcode while the part circled by red dotted line is a five-digit add-on code.



**\*\* Disable 5-Digit Add-On Code**



**Enable 5-Digit Add-On Code**



**Disable 5-Digit Add-On Code:** The scanner decodes UPC-A and ignores the add-on code when presented with a UPC-A plus 5-digit add-on barcode. It can also decode UPC-A barcodes without 5-digit add-on codes.

**Enable 5-Digit Add-On Code:** The scanner decodes a mix of UPC-A barcodes with and without 5-digit add-on codes.

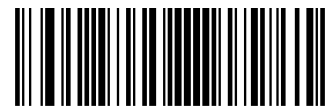

@SETUPE0  
**\*\* Exit Setup**



@SETUPE1  
Enter Setup

---

### Add-On Code Required

When **UPC-A Add-On Code Required** is selected, the scanner will only read UPC-A barcodes that contain add-on codes.



@UPAREQ0  
**\*\* UPC-A Add-On Code Not Required**



@UPAREQ1  
**UPC-A Add-On Code Required**

### Transmit Preamble Character

Preamble characters (Country Code and System Character) can be transmitted as part of a UPC-A barcode. Select one of the following options for transmitting UPC-A preamble to the host device: transmit system character only, transmit system character and country code ("0" for USA), or transmit no preamble.



@UPAPRE0  
**No Preamble**



@UPAPRE1  
**\*\* System Character**



@UPAPRE2  
**System Character & Country Code**



@SETUPE0  
**\*\* Exit Setup**



@SETUPE1  
Enter Setup

## Coupon

### UPC-A/EAN-13 with Extended Coupon Code

The following three types of coupon code + extended coupon code are supported:

- ✧ UPC-A (starting with “5”) + GS1-128
- ✧ UPC-A (starting with “5”) + GS1 Databar
- ✧ EAN-13 (starting with “99”) + GS1-128

Use the appropriate barcode below to enable or disable UPC-A/EAN-13 with Extended Coupon Code. When left on the default setting (**Off**), the scanner treats Coupon Codes and Extended Coupon Codes as single bar codes.

If you scan the **Allow Concatenation** code, when the scanner sees the coupon code and the extended coupon code in a single scan, it transmits both as separate symbologies. Otherwise, it transmits the first coupon code it reads.

If you scan the **Require Concatenation** code, the scanner must see and read the coupon code and extended coupon code in a single read to transmit the data. No data is output unless both codes are read.



@CPNENA0  
**\*\* Off**



@CPNENA1  
**Allow Concatenation**



@CPNENA2  
**Require Concatenation**



When using the UPC-A Coupon feature, please ensure that **System Character** or **System Character & Country Code** is selected for the “Transmit UPC-A Preamble Character” feature.



@SETUPE0  
**\*\* Exit Setup**



@SETUPE1  
Enter Setup

---

### Coupon GS1 Databar Output

If you scan coupons that have both UPC and GS1 Databar codes, you may wish to scan and output only the data from the GS1 Databar code. Scan the **GS1 Output On** barcode below to scan and output only the GS1 Databar code data.

When **GS1 Output Off** is selected, coupons that have both UPC and GS1 Databar codes are transmitted depending on your selection for the "UPC-A/EAN-13 with Extended Coupon Code" feature.



@CPNGS10  
**\*\* GS1 Output Off**



@CPNGS11  
**GS1 Output On**



When using the UPC-A Coupon feature, please ensure that **System Character** or **System Character & Country Code** is selected for the "Transmit UPC-A Preamble Character" feature.



@SETUPE0  
**\*\* Exit Setup**



@SETUPE1  
**Enter Setup**

---

## Interleaved 2 of 5

### Restore Factory Defaults



@I25DEF

**Restore the Factory Defaults of Interleaved 2 of 5**

### Enable/Disable Interleaved 2 of 5



@I25ENA1

**\*\* Enable Interleaved 2 of 5**



@I25ENA0

**Disable Interleaved 2 of 5**



If the scanner fails to identify Interleaved 2 of 5 barcodes, you may first try this solution by scanning the **Enter Setup** barcode and then **Enable Interleaved 2 of 5** barcode.



@SETUPE0

**\*\* Exit Setup**



@SETUPE1  
Enter Setup

## Set Length Range for Interleaved 2 of 5

The scanner can be configured to only decode Interleaved 2 of 5 barcodes with lengths that fall between (inclusive) the minimum and maximum lengths. To accomplish it, you need to set the minimum and maximum lengths.



@I25MIN

**Set the Minimum Length (Default: 6)**



@I25MAX

**Set the Maximum Length (Default: 80)**



If minimum length is set to be greater than maximum length, the scanner only decodes Interleaved 2 of 5 barcodes with either the minimum or maximum length. If minimum length is same as maximum length, only Interleaved 2 of 5 barcodes with that length are to be decoded.



**Set the scanner to decode Interleaved 2 of 5 barcodes containing between 8 and 12 characters:**

1. Scan the **Enter Setup** barcode.
2. Scan the **Set the Minimum Length** barcode.
3. Scan the numeric barcode “8” from the “Digit Barcodes” section in Appendix.
4. Scan the **Save** barcode from the “Save/Cancel Barcodes” section in Appendix.
5. Scan the **Set the Maximum Length** barcode.
6. Scan the numeric barcodes “1” and “2” from the “Digit Barcodes” section in Appendix.
7. Scan the **Save** barcode from the “Save/Cancel Barcodes” section in Appendix.
8. Scan the **Exit Setup** barcode.



@SETUPE0

**\*\* Exit Setup**



@SETUPE1  
Enter Setup

## Check Character Verification

A check character is optional for Interleaved 2 of 5 and can be added as the last character. It is a calculated value used to verify the integrity of the data.

- ✧ **Disable:** The scanner transmits Interleaved 2 of 5 barcodes as is.
- ✧ **Do Not Transmit Check Character After Verification:** The scanner checks the integrity of all Interleaved 2 of 5 barcodes to verify that the data complies with the check character algorithm. Barcodes passing the check will be transmitted except the last digit, whereas those failing it will not be transmitted.
- ✧ **Transmit Check Character After Verification:** The scanner checks the integrity of all Interleaved 2 of 5 barcodes to verify that the data complies with the check character algorithm. Barcodes passing the check will be transmitted, whereas those failing it will not be transmitted.

Since Interleaved 2 of 5 must always have an even number of digits, a zero may need to be added as the first digit when the check character is added. The check character is automatically generated when making Interleaved 2 of 5 barcodes.



@I25CHK0  
**\*\* Disable**



@I25CHK1

**Do Not Transmit Check Character After Verification**



@I25CHK2

**Transmit Check Character After Verification**



If the **Do Not Transmit Check Character After Verification** option is enabled, Interleaved 2 of 5 barcodes with a length that is less than the configured minimum length after having the check character excluded will not be decoded. (For example, when the **Do Not Transmit Check Character After Verification** option is enabled and the minimum length is set to 4, Interleaved 2 of 5 barcodes with a total length of 4 characters including the check character cannot be read.)

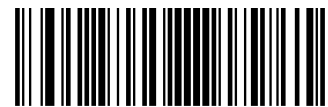

@SETUPE0  
**\*\* Exit Setup**



@SETUPE1  
Enter Setup

---

## Febraban

### Disable/Enable Febraban

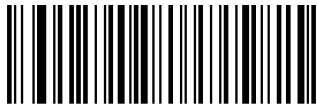

@I25FBB0  
\*\* Disable Febraban

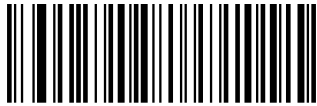

@I25FBB2  
Enable Febraban, Expand



@I25FBB1  
Enable Febraban, Do Not Expand

### Transmit Delay per Character

**Transmit Delay per Character** applies to both Expanded and Unexpanded Febraban. This feature is available only when USB HID Keyboard is enabled.



@FEBSN0  
\*\* Disable Transmit Delay per Character



@FEBSN1  
Enable Transmit Delay per Character



@SETUPE0  
\*\* Exit Setup





@SETUPE1  
**Enter Setup**

---

You may select an appropriate delay value from the options below as per your actual needs.



@FEBSDT0  
**0ms**



@FEBSDT5  
**5ms**



@FEBSDT10  
**10ms**



@FEBSDT15  
**15ms**



@FEBSDT20  
**20ms**



@FEBSDT25  
**25ms**



@FEBSDT30  
**30ms**



@FEBSDT35  
**35ms**



@SETUPE0  
**\*\* Exit Setup**



@SETUPE1  
**Enter Setup**

---



@FEBSDT40  
**40ms**



@FEBSDT45  
**45ms**



@FEBSDT50  
**50ms**



@FEBSDT55  
**55ms**



@FEBSDT60  
**60ms**



@FEBSDT65  
**65ms**

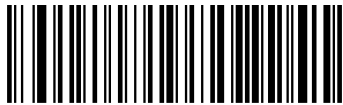

@FEBSDT70  
**\*\* 70ms**



@FEBSDT75  
**75ms**



@SETUPE0  
**\*\* Exit Setup**



@SETUPE1  
**Enter Setup**

### Transmit Delay per 12 Characters

**Transmit Delay per 12 Characters** applies to Expanded Febraban only. This feature is available only when USB HID Keyboard is enabled.



@FEBMEN0

**\*\* Disable Transmit Delay per 12 Characters**



@FEBMEN1

**Enable Transmit Delay per 12 Characters**

You may select an appropriate delay value from the options below as per your actual needs.



@FEBMDT0

**0ms**



@FEBMDT1

**300ms**



@FEBMDT2

**400ms**

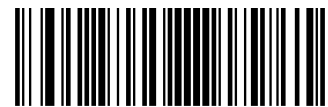

@SETUPE0  
**\*\* Exit Setup**



@SETUPE1  
**Enter Setup**

---



@FEBMDT4  
**600ms**



@FEBMDT6  
**800ms**



@FEBMDT3  
**\*\* 500ms**



@FEBMDT5  
**700ms**



@FEBMDT7  
**900ms**



@SETUPE0  
**\*\* Exit Setup**



@SETUPE1  
**Enter Setup**

## ITF-14

ITF-14 is a special kind of Interleaved 2 of 5 with a length of 14 characters and the last character as the check character.

ITF-14 priority principle: For the Interleaved 2 of 5 barcodes with a length of 14 characters and the last character as the check character, the ITF-14 configurations shall take precedence over the Interleaved 2 of 5 settings.

### Restore Factory Defaults



**Restore the Factory Defaults of ITF-14**

### Enable/Disable ITF-14



**\*\* Disable ITF-14**



**Enable ITF-14 But Do Not Transmit Check Character**



**Enable ITF-14 and Transmit Check Character**



An example of the ITF-14 priority principle: when ITF-14 is enabled and Interleaved 2 of 5 is disabled, the scanner only decodes Interleaved 2 of 5 barcodes with a length of 14 characters and the last character as the check character.



@SETUPE0  
**\*\* Exit Setup**



@SETUPE1  
Enter Setup

---

## ITF-6

ITF-6 is a special kind of Interleaved 2 of 5 with a length of 6 characters and the last character as the check character.

ITF-6 priority principle: For the Interleaved 2 of 5 barcodes with a length of 6 characters and the last character as the check character, the ITF-6 configurations shall take precedence over the Interleaved 2 of 5 settings.

### Restore Factory Defaults



@IT6DEF  
Restore the Factory Defaults of ITF-6

### Enable/Disable ITF-6



@IT6ENA0  
\*\* Disable ITF-6



@IT6ENA1  
Enable ITF-6 But Do Not Transmit Check Character



@IT6ENA2  
Enable ITF-6 and Transmit Check Character



An example of the ITF-6 priority principle: when ITF-6 is enabled and Interleaved 2 of 5 is disabled, the scanner only decodes Interleaved 2 of 5 barcodes with a length of 6 characters and the last character as the check character.



@SETUPE0  
\*\* Exit Setup



@SETUPE1  
**Enter Setup**

---

## Matrix 2 of 5

### Restore Factory Defaults



@M25DEF

**Restore the Factory Defaults of Matrix 2 of 5**

### Enable/Disable Matrix 2 of 5



@M25ENA1

**\*\* Enable Matrix 2 of 5**



@M25ENA0

**Disable Matrix 2 of 5**



If the scanner fails to identify Matrix 2 of 5 barcodes, you may first try this solution by scanning the **Enter Setup** barcode and then **Enable Matrix 2 of 5** barcode.

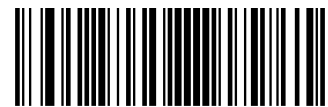

@SETUPE0  
**\*\* Exit Setup**



@SETUPE1  
Enter Setup

## Set Length Range for Matrix 2 of 5

The scanner can be configured to only decode Matrix 2 of 5 barcodes with lengths that fall between (inclusive) the minimum and maximum lengths. To accomplish it, you need to set the minimum and maximum lengths.



@M25MIN

**Set the Minimum Length (Default: 4)**



@M25MAX

**Set the Maximum Length (Default: 80)**



If minimum length is set to be greater than maximum length, the scanner only decodes Matrix 2 of 5 barcodes with either the minimum or maximum length. If minimum length is same as maximum length, only Matrix 2 of 5 barcodes with that length are to be decoded.

**E**  
*sample*

**Set the scanner to decode Matrix 2 of 5 barcodes containing between 8 and 12 characters:**

1. Scan the **Enter Setup** barcode.
2. Scan the **Set the Minimum Length** barcode.
3. Scan the numeric barcode “8” from the “Digit Barcodes” section in Appendix.
4. Scan the **Save** barcode from the “Save/Cancel Barcodes” section in Appendix.
5. Scan the **Set the Maximum Length** barcode.
6. Scan the numeric barcodes “1” and “2” from the “Digit Barcodes” section in Appendix.
7. Scan the **Save** barcode from the “Save/Cancel Barcodes” section in Appendix.
8. Scan the **Exit Setup** barcode.



@SETUPE0

**\*\* Exit Setup**





@SETUPE1  
Enter Setup

## Check Character Verification

A check character is optional for Matrix 2 of 5 and can be added as the last character. It is a calculated value used to verify the integrity of the data.

- ✧ **Disable:** The scanner transmits Matrix 2 of 5 barcodes as is.
- ✧ **Do Not Transmit Check Character After Verification:** The scanner checks the integrity of all Matrix 2 of 5 barcodes to verify that the data complies with the check character algorithm. Barcodes passing the check will be transmitted except the last digit, whereas those failing it will not be transmitted.
- ✧ **Transmit Check Character After Verification:** The scanner checks the integrity of all Matrix 2 of 5 barcodes to verify that the data complies with the check character algorithm. Barcodes passing the check will be transmitted, whereas those failing it will not be transmitted.

Since Matrix 2 of 5 must always have an even number of digits, a zero may need to be added as the first digit when the check character is added. The check character is automatically generated when making Matrix 2 of 5 barcodes.



@M25CHK0  
**\*\* Disable**



@M25CHK1

**Do Not Transmit Check Character After Verification**



@M25CHK2

**Transmit Check Character After Verification**



If the **Do Not Transmit Check Character After Verification** option is enabled, Matrix 2 of 5 barcodes with a length that is less than the configured minimum length after having the check character excluded will not be decoded. (For example, when the **Do Not Transmit Check Character After Verification** option is enabled and the minimum length is set to 4, Matrix 2 of 5 barcodes with a total length of 4 characters including the check character cannot be read.)

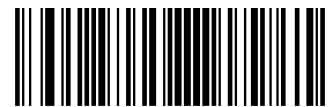

@SETUPE0  
**\*\* Exit Setup**



@SETUPE1  
**Enter Setup**

---

## Code 39

### Restore Factory Defaults



@C39DEF  
**Restore the Factory Defaults of Code 39**

### Enable/Disable Code 39



@C39ENA1  
**\*\* Enable Code 39**



@C39ENA0  
**Disable Code 39**



If the scanner fails to identify Code 39 barcodes, you may first try this solution by scanning the **Enter Setup** barcode and then **Enable Code 39** barcode.



@SETUPE0  
**\*\* Exit Setup**



@SETUPE1  
**Enter Setup**

## Set Length Range for Code 39

The scanner can be configured to only decode Code 39 barcodes with lengths that fall between (inclusive) the minimum and maximum lengths. To accomplish it, you need to set the minimum and maximum lengths.



@C39MIN

**Set the Minimum Length (Default: 1)**



@C39MAX

**Set the Maximum Length (Default: 48)**



If minimum length is set to be greater than maximum length, the scanner only decodes Code 39 barcodes with either the minimum or maximum length. If minimum length is same as maximum length, only Code 39 barcodes with that length are to be decoded.



**Set the scanner to decode Code 39 barcodes containing between 8 and 12 characters:**

1. Scan the **Enter Setup** barcode.
2. Scan the **Set the Minimum Length** barcode.
3. Scan the numeric barcode “8” from the “Digit Barcodes” section in Appendix.
4. Scan the **Save** barcode from the “Save/Cancel Barcodes” section in Appendix.
5. Scan the **Set the Maximum Length** barcode.
6. Scan the numeric barcodes “1” and “2” from the “Digit Barcodes” section in Appendix.
7. Scan the **Save** barcode from the “Save/Cancel Barcodes” section in Appendix.
8. Scan the **Exit Setup** barcode.

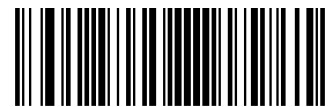

@SETUPE0  
**\*\* Exit Setup**



@SETUPE1  
Enter Setup

## Check Character Verification

A check character is optional for Code 39 and can be added as the last character. It is a calculated value used to verify the integrity of the data.

- ✧ **Disable:** The scanner transmits Code 39 barcodes as is.
- ✧ **Do Not Transmit Check Character After Verification:** The scanner checks the integrity of all Code 39 barcodes to verify that the data complies with the check character algorithm. Barcodes passing the check will be transmitted except the last digit, whereas those failing it will not be transmitted.
- ✧ **Transmit Check Character After Verification:** The scanner checks the integrity of all Code 39 barcodes to verify that the data complies with the check character algorithm. Barcodes passing the check will be transmitted, whereas those failing it will not be transmitted.



@C39CHK0  
\*\* Disable



@C39CHK1  
**Do Not Transmit Check Character After Verification**



@C39CHK2

**Transmit Check Character After Verification**



If the **Do Not Transmit Check Character After Verification** option is enabled, Code 39 barcodes with a length that is less than the configured minimum length after having the check character excluded will not be decoded. (For example, when the **Do Not Transmit Check Character After Verification** option is enabled and the minimum length is set to 4, Code 39 barcodes with a total length of 4 characters including the check character cannot be read.)



@SETUPE0  
\*\* Exit Setup



@SETUPE1  
**Enter Setup**

### Transmit Start/Stop Character

Code 39 uses an asterisk (\*) for both the start and the stop characters. You can choose whether or not to transmit the start/stop characters by scanning the appropriate barcode below.



@C39TSC0

**\*\* Do Not Transmit Start/Stop Character**



@C39TSC1

**Transmit Start/Stop Character**

### Enable/Disable Code 39 Full ASCII

The scanner can be configured to identify all ASCII characters by scanning the appropriate barcode below.



@C39ASC0

**\*\* Disable Code 39 Full ASCII**



@C39ASC1

**Enable Code 39 Full ASCII**

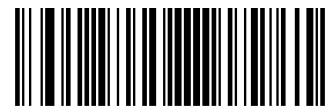

@SETUPE0  
**\*\* Exit Setup**



@SETUPE1  
**Enter Setup**

---

### Enable/Disable Code 32 (Italian Pharma Code)

Code 32 is a variant of Code 39 used by the Italian pharmaceutical industry. Scan the appropriate bar code below to enable or disable Code 32. Code 39 must be enabled and Code 39 check character verification must be disabled for this parameter to function.



@C39E320  
**\*\* Disable Code 32**



@C39E321  
**Enable Code 32**

### Code 32 Prefix

Scan the appropriate barcode below to enable or disable adding the prefix character "A" to all Code 32 barcodes. Code 32 must be enabled for this parameter to function.



@C39S320  
**\*\* Disable Code 32 Prefix**



@C39S321  
**Enable Code 32 Prefix**



@SETUPE0  
**\*\* Exit Setup**



@SETUPE1  
**Enter Setup**

---

### Transmit Code 32 Start/Stop Character

Code 32 must be enabled for this parameter to function.



@C39T320

**\*\* Do Not Transmit Code 32 Start/Stop Character**



@C39T321

**Transmit Code 32 Start/Stop Character**

### Transmit Code 32 Check Character

Code 32 must be enabled for this parameter to function.



@C39C320

**\*\* Do Not Transmit Code 32 Check Character**



@C39C321

**Transmit Code 32 Check Character**

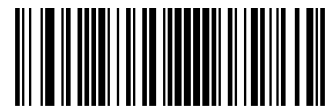

@SETUPE0  
**\*\* Exit Setup**



@SETUPE1  
**Enter Setup**

---

## Codabar

### Restore Factory Defaults



@CBADEF  
**Restore the Factory Defaults of Codabar**

### Enable/Disable Codabar



@CBAENA1  
**Enable Codabar**



@CBAENA0  
**\*\* Disable Codabar**



If the scanner fails to identify Codabar barcodes, you may first try this solution by scanning the **Enter Setup** barcode and then **Enable Codabar** barcode.



@SETUPE0  
**\*\* Exit Setup**





@SETUPE1  
Enter Setup

### Set Length Range for Codabar

The scanner can be configured to only decode Codabar barcodes with lengths that fall between (inclusive) the minimum and maximum lengths. To accomplish it, you need to set the minimum and maximum lengths.



**Set the Minimum Length (Default: 2)**



**Set the Maximum Length (Default: 60)**



If minimum length is set to be greater than maximum length, the scanner only decodes Codabar barcodes with either the minimum or maximum length. If minimum length is same as maximum length, only Codabar barcodes with that length are to be decoded.



**Set the scanner to decode Codabar barcodes containing between 8 and 12 characters:**

1. Scan the **Enter Setup** barcode.
2. Scan the **Set the Minimum Length** barcode.
3. Scan the numeric barcode “8” from the “Digit Barcodes” section in Appendix.
4. Scan the **Save** barcode from the “Save/Cancel Barcodes” section in Appendix.
5. Scan the **Set the Maximum Length** barcode.
6. Scan the numeric barcodes “1” and “2” from the “Digit Barcodes” section in Appendix.
7. Scan the **Save** barcode from the “Save/Cancel Barcodes” section in Appendix.
8. Scan the **Exit Setup** barcode.

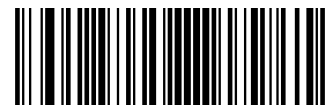

@SETUPE0  
\*\* Exit Setup



@SETUPE1  
Enter Setup

## Check Character Verification

A check character is optional for Codabar and can be added as the last character. It is a calculated value used to verify the integrity of the data.

- ✧ **Disable:** The scanner transmits Codabar barcodes as is.
- ✧ **Do Not Transmit Check Character After Verification:** The scanner checks the integrity of all Codabar barcodes to verify that the data complies with the check character algorithm. Barcodes passing the check will be transmitted except the last digit, whereas those failing it will not be transmitted.
- ✧ **Transmit Check Character After Verification:** The scanner checks the integrity of all Codabar barcodes to verify that the data complies with the check character algorithm. Barcodes passing the check will be transmitted, whereas those failing it will not be transmitted.



@CBACHK0  
**\*\* Disable**



@CBACHK1

**Do Not Transmit Check Character After Verification**

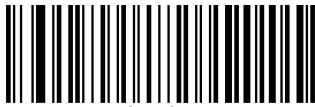

@CBACHK2

**Transmit Check Character After Verification**



If the **Do Not Transmit Check Character After Verification** option is enabled, Codabar barcodes with a length that is less than the configured minimum length after having the check character excluded will not be decoded. (For example, when the **Do Not Transmit Check Character After Verification** option is enabled and the minimum length is set to 4, Codabar barcodes with a total length of 4 characters including the check character cannot be read.)



@SETUPE0  
**\*\* Exit Setup**



@SETUPE1  
**Enter Setup**

### Start/Stop Character

You can set the start/stop characters and choose whether or not to transmit the start/stop characters by scanning the appropriate barcode below.



@CBATSC0

**\*\* Do Not Transmit Start/Stop Character**



@CBATSC1

**Transmit Start/Stop Character**



@CBASCF0

**\*\* ABCD/ABCD as the Start/Stop Character**



@CBASCF1

**ABCD/TN\*E as the Start/Stop Character**



@CBASCF2

**abcd/abcd as the Start/Stop Character**



@CBASCF3

**abcd/tn\*e as the Start/Stop Character**

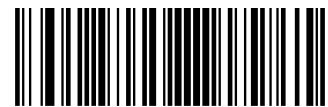

@SETUPE0  
**\*\* Exit Setup**



@SETUPE1  
**Enter Setup**

---

## Code 93

### Restore Factory Defaults



@C93DEF  
**Restore the Factory Defaults of Code 93**

### Enable/Disable Code 93



@C93ENA1  
**Enable Code 93**



@C93ENA0  
**\*\* Disable Code 93**



If the scanner fails to identify Code 93 barcodes, you may first try this solution by scanning the **Enter Setup** barcode and then **Enable Code 93** barcode.



@SETUPE0  
**\*\* Exit Setup**



@SETUPE1  
**Enter Setup**

### Set Length Range for Code 93

The scanner can be configured to only decode Code 93 barcodes with lengths that fall between (inclusive) the minimum and maximum lengths. To accomplish it, you need to set the minimum and maximum lengths.



@C93MIN

**Set the Minimum Length (Default: 1)**



@C93MAX

**Set the Maximum Length (Default: 48)**



If minimum length is set to be greater than maximum length, the scanner only decodes Code 93 barcodes with either the minimum or maximum length. If minimum length is same as maximum length, only Code 93 barcodes with that length are to be decoded.



**Set the scanner to decode Code 93 barcodes containing between 8 and 12 characters:**

1. Scan the **Enter Setup** barcode.
2. Scan the **Set the Minimum Length** barcode.
3. Scan the numeric barcode "8" from the "Digit Barcodes" section in Appendix.
4. Scan the **Save** barcode from the "Save/Cancel Barcodes" section in Appendix.
5. Scan the **Set the Maximum Length** barcode.
6. Scan the numeric barcodes "1" and "2" from the "Digit Barcodes" section in Appendix.
7. Scan the **Save** barcode from the "Save/Cancel Barcodes" section in Appendix.
8. Scan the **Exit Setup** barcode.

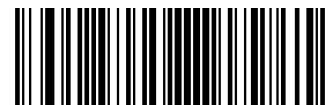

@SETUPE0  
**\*\* Exit Setup**



@SETUPE1  
Enter Setup

## Check Character Verification

Check characters are optional for Code 93 and can be added as the last two characters, which are calculated values used to verify the integrity of the data.

- ✧ **Disable:** The scanner transmits Code 93 barcodes as is.
- ✧ **Do Not Transmit Check Character After Verification:** The scanner checks the integrity of all Code 93 barcodes to verify that the data complies with the check character algorithm. Barcodes passing the checks will be transmitted except the last two digits, whereas those failing them will not be transmitted.
- ✧ **Transmit Check Character After Verification:** The scanner checks the integrity of all Code 93 barcodes to verify that the data complies with the check character algorithm. Barcodes passing the checks will be transmitted, whereas those failing them will not be transmitted.



@C93CHK0  
Disable



@C93CHK1

**\*\* Do Not Transmit Check Character After Verification**



@C93CHK2

**Transmit Check Character After Verification**



If the **Do Not Transmit Check Character After Verification** option is enabled, Code 93 barcodes with a length that is less than the configured minimum length after having the two check characters excluded will not be decoded. (For example, when the **Do Not Transmit Check Character After Verification** option is enabled and the minimum length is set to 4, Code 93 barcodes with a total length of 4 characters including the two check characters cannot be read.)



@SETUPE0  
**\*\* Exit Setup**



@SETUPE1  
**Enter Setup**

## China Post 25

### Restore Factory Defaults



@CHPDEF

**Restore the Factory Defaults of China Post 25**

### Enable/Disable China Post 25



@CHPEN A1

**Enable China Post 25**



@CHPEN A0

**\*\* Disable China Post 25**



If the scanner fails to identify China Post 25 barcodes, you may first try this solution by scanning the **Enter Setup** barcode and then **Enable China Post 25** barcode.

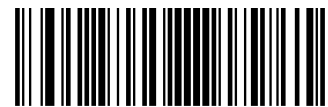

@SETUPE0  
**\*\* Exit Setup**



@SETUPE1  
Enter Setup

## Set Length Range for China Post 25

The scanner can be configured to only decode China Post 25 barcodes with lengths that fall between (inclusive) the minimum and maximum lengths. To accomplish it, you need to set the minimum and maximum lengths.



@CHPMIN  
Set the Minimum Length (Default: 1)



@CHPMAX  
Set the Maximum Length (Default: 48)



If minimum length is set to be greater than maximum length, the scanner only decodes China Post 25 barcodes with either the minimum or maximum length. If minimum length is same as maximum length, only China Post 25 barcodes with that length are to be decoded.

**E**  
*xample*

**Set the scanner to decode China Post 25 barcodes containing between 8 and 12 characters:**

1. Scan the **Enter Setup** barcode.
2. Scan the **Set the Minimum Length** barcode.
3. Scan the numeric barcode “8” from the “Digit Barcodes” section in Appendix.
4. Scan the **Save** barcode from the “Save/Cancel Barcodes” section in Appendix.
5. Scan the **Set the Maximum Length** barcode.
6. Scan the numeric barcodes “1” and “2” from the “Digit Barcodes” section in Appendix.
7. Scan the **Save** barcode from the “Save/Cancel Barcodes” section in Appendix.
8. Scan the **Exit Setup** barcode.



@SETUPE0  
\*\* Exit Setup





@SETUPE1  
Enter Setup

## Check Character Verification

A check character is optional for China Post 25 and can be added as the last character. It is a calculated value used to verify the integrity of the data.

- ✧ **Disable:** The scanner transmits China Post 25 barcodes as is.
- ✧ **Do Not Transmit Check Character After Verification:** The scanner checks the integrity of all China Post 25 barcodes to verify that the data complies with the check character algorithm. Barcodes passing the check will be transmitted except the last digit, whereas those failing it will not be transmitted.
- ✧ **Transmit Check Character After Verification:** The scanner checks the integrity of all China Post 25 barcodes to verify that the data complies with the check character algorithm. Barcodes passing the check will be transmitted, whereas those failing it will not be transmitted.



@CHPCHK0  
\*\* Disable



@CHPCHK1

**Do Not Transmit Check Character After Verification**



@CHPCHK2

**Transmit Check Character After Verification**



If the **Do Not Transmit Check Character After Verification** option is enabled, China Post 25 barcodes with a length that is less than the configured minimum length after having the check character excluded will not be decoded. (For example, when the **Do Not Transmit Check Character After Verification** option is enabled and the minimum length is set to 4, China Post 25 barcodes with a total length of 4 characters including the check character cannot be read.)



@SETUPE0  
\*\* Exit Setup



@SETUPE1  
Enter Setup

---

## GS1-128 (UCC/EAN-128)

### Restore Factory Defaults



@GS1DEF  
Restore the Factory Defaults of GS1-128

### Enable/Disable GS1-128



@GS1ENA1  
\*\* Enable GS1-128



@GS1ENA0  
Disable GS1-128



If the scanner fails to identify GS1-128 barcodes, you may first try this solution by scanning the **EnterSetup** barcode and then **Enable GS1-128** barcode.



@SETUPE0  
\*\* Exit Setup



@SETUPE1  
**Enter Setup**

### Set Length Range for GS1-128

The scanner can be configured to only decode GS1-128 barcodes with lengths that fall between (inclusive) the minimum and maximum lengths. To accomplish it, you need to set the minimum and maximum lengths.



@GS1MIN

**Set the Minimum Length (Default: 1)**



@GS1MAX

**Set the Maximum Length (Default: 48)**



If minimum length is set to be greater than maximum length, the scanner only decodes GS1-128 barcodes with either the minimum or maximum length. If minimum length is same as maximum length, only GS1-128 barcodes with that length are to be decoded.



**Set the scanner to decode GS1-128 barcodes containing between 8 and 12 characters:**

1. Scan the **Enter Setup** barcode.
2. Scan the **Set the Minimum Length** barcode.
3. Scan the numeric barcode "8" from the "Digit Barcodes" section in Appendix.
4. Scan the **Save** barcode from the "Save/Cancel Barcodes" section in Appendix.
5. Scan the **Set the Maximum Length** barcode.
6. Scan the numeric barcodes "1" and "2" from the "Digit Barcodes" section in Appendix.
7. Scan the **Save** barcode from the "Save/Cancel Barcodes" section in Appendix.
8. Scan the **Exit Setup** barcode.



@SETUPE0  
**\*\* Exit Setup**



@SETUPE1  
Enter Setup

---

## GS1 Databar (RSS)

### Restore Factory Defaults



@RSSDEF

Restore the Factory Defaults of GS1 Databar

### Enable/Disable GS1 Databar



@RSSENA1

\*\* Enable GS1 Databar



@RSSENA0

Disable GS1 Databar



If the scanner fails to identify GS1 Databar barcodes, you may first try this solution by scanning the **Enter Setup** barcode and then **Enable GS1 Databar** barcode.



@SETUPE0  
\*\* Exit Setup



@SETUPE1  
Enter Setup

### Transmit Application Identifier "01"



@RSSTAI1

\*\* Transmit Application Identifier "01"



@RSSTAI0

Do Not Transmit Application Identifier "01"

### GS1 Composite (EAN-UCC Composite)

#### Restore Factory Defaults



@CPTDEF

Restore the Factory Defaults of GS1 Composite

#### Enable/Disable GS1 Composite



@CPTENA1

\*\* Enable GS1 Composite



@CPTENA0

Disable GS1 Composite



If the scanner fails to identify GS1 Composite barcodes, you may first try this solution by scanning the **Enter Setup** barcode and then **Enable GS1 Composite** barcode.



@SETUPE0

\*\* Exit Setup



@SETUPE1

**Enter Setup**

### Enable/Disable UPC/EAN Composite



@CPTUPC1

**Enable UPC/EAN Composite**



@CPTUPC0

**\*\* Disable UPC/EAN Composite**

## Code 11

### Restore Factory Defaults



@C11DEF

**Restore the Factory Defaults of Code 11**

### Enable/Disable Code 11



@C11ENA1

**Enable Code 11**



@C11ENA0

**\*\* Disable Code 11**



If the scanner fails to identify Code 11 barcodes, you may first try this solution by scanning the **Enter Setup** barcode and then **Enable Code 11** barcode.



@SETUPE0

**\*\* Exit Setup**



@SETUPE1  
**Enter Setup**

## Set Length Range for Code 11

The scanner can be configured to only decode Code 11 barcodes with lengths that fall between (inclusive) the minimum and maximum lengths. To accomplish it, you need to set the minimum and maximum lengths.



@C11MIN

**Set the Minimum Length (Default: 4)**



@C11MAX

**Set the Maximum Length (Default: 48)**



If minimum length is set to be greater than maximum length, the scanner only decodes Code 11 barcodes with either the minimum or maximum length. If minimum length is same as maximum length, only Code 11 barcodes with that length are to be decoded.



**Set the scanner to decode Code 11 barcodes containing between 8 and 12 characters:**

1. Scan the **Enter Setup** barcode.
2. Scan the **Set the Minimum Length** barcode.
3. Scan the numeric barcode “8” from the “Digit Barcodes” section in Appendix.
4. Scan the **Save** barcode from the “Save/Cancel Barcodes” section in Appendix.
5. Scan the **Set the Maximum Length** barcode.
6. Scan the numeric barcodes “1” and “2” from the “Digit Barcodes” section in Appendix.
7. Scan the **Save** barcode from the “Save/Cancel Barcodes” section in Appendix.
8. Scan the **Exit Setup** barcode.

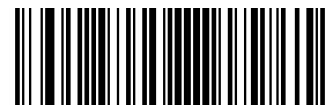

@SETUPE0  
**\*\* Exit Setup**



@SETUPE1  
Enter Setup

---

### Check Character Verification

Check characters are optional for Code 11 and can be added as the last one or two characters, which are calculated values used to verify the integrity of the data.

If the **Disable** option is enabled, the scanner transmits Code 11 barcodes as is.



@C11CHK0  
**Disable**



@C11CHK1  
**\*\* One Check Character, MOD11**



@C11CHK2  
**Two Check Characters, MOD11/MOD11**



@C11CHK3  
**Two Check Characters, MOD11/MOD9**



@C11CHK4  
**One Check Character, MOD11 (Len<=10)**  
**Two Check Characters, MOD11/MOD11(Len>10)**



@C11CHK5  
**One Check Character, MOD11 (Len<=10)**  
**Two Check Characters, MOD11/MOD9 (Len>10)**



@SETUPE0  
**\*\* Exit Setup**





@SETUPE1  
Enter Setup

### Transmit Check Character



@C11TCK0

Do Not Transmit Code 11 Check Character



@C11TCK1

\*\* Transmit Code 11 Check Character



If you select a check character algorithm and the **Do Not Transmit Check Character** option, Code 11 barcodes with a length that is less than the configured minimum length after having the check character(s) excluded will not be decoded. (For example, when the **One Check Character, MOD11** and **Do Not Transmit Check Character** options are enabled and the minimum length is set to 4, Code 11 barcodes with a total length of 4 characters including the check character cannot be read.)



@SETUPE0  
\*\* Exit Setup



@SETUPE1  
**Enter Setup**

---

## ISBN

### Restore Factory Defaults



@ISBDEF  
**Restore the Factory Defaults of ISBN**

### Enable/Disable ISBN



@ISBENA1  
**Enable ISBN**



@ISBENA0  
**\*\* Disable ISBN**



If the scanner fails to identify ISBN barcodes, you may first try this solution by scanning the **Enter Setup** barcode and then **Enable ISBN** barcode.



@SETUPE0  
**\*\* Exit Setup**



@SETUPE1  
**Enter Setup**

---

### Set ISBN Format



@ISBT101  
**\*\* ISBN-10**



@ISBT100  
**ISBN-13**

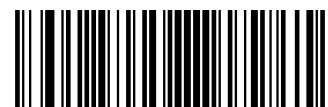

@SETUPE0  
**\*\* Exit Setup**



@SETUPE1  
**Enter Setup**

---

## ISSN

### Restore Factory Defaults



@ISSDEF  
**Restore the Factory Defaults of ISSN**

### Enable/Disable ISSN



@ISSENA1  
**\*\*Enable ISSN**



@ISSENA0  
**Disable ISSN**



If the scanner fails to identify ISSN barcodes, you may first try this solution by scanning the **Enter Setup** barcode and then **Enable ISSN** barcode.



@SETUPE0  
**\*\* Exit Setup**



@SETUPE1  
**Enter Setup**

## Industrial 25

### Restore Factory Defaults

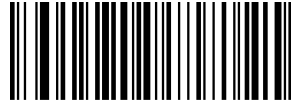

@L25DEF

**Restore the Factory Defaults of Industrial 25**

### Enable/Disable Industrial 25



@L25ENA1

**Enable Industrial 25**



@L25ENA0

**\*\* Disable Industrial 25**



If the scanner fails to identify Industrial 25 barcodes, you may first try this solution by scanning the **Enter Setup** barcode and then **Enable Industrial 25** barcode.



@SETUPE0  
**\*\* Exit Setup**



@SETUPE1  
Enter Setup

## Set Length Range for Industrial 25

The scanner can be configured to only decode Industrial 25 barcodes with lengths that fall between (inclusive) the minimum and maximum lengths. To accomplish it, you need to set the minimum and maximum lengths.



@L25MIN

**Set the Minimum Length (Default: 6)**



@L25MAX

**Set the Maximum Length (Default: 48)**



If minimum length is set to be greater than maximum length, the scanner only decodes Industrial 25 barcodes with either the minimum or maximum length. If minimum length is same as maximum length, only Industrial 25 barcodes with that length are to be decoded.

**E**  
*xample*

**Set the scanner to decode Industrial 25 barcodes containing between 8 and 12 characters:**

1. Scan the **Enter Setup** barcode.
2. Scan the **Set the Minimum Length** barcode.
3. Scan the numeric barcode “8” from the “Digit Barcodes” section in Appendix.
4. Scan the **Save** barcode from the “Save/Cancel Barcodes” section in Appendix.
5. Scan the **Set the Maximum Length** barcode.
6. Scan the numeric barcodes “1” and “2” from the “Digit Barcodes” section in Appendix.
7. Scan the **Save** barcode from the “Save/Cancel Barcodes” section in Appendix.
8. Scan the **Exit Setup** barcode.



@SETUPE0

**\*\* Exit Setup**



@SETUPE1  
Enter Setup

## Check Character Verification

A check character is optional for Industrial 25 and can be added as the last character. It is a calculated value used to verify the integrity of the data.

- ✧ **Disable:** The scanner transmits Industrial 25 barcodes as is.
- ✧ **Do Not Transmit Check Character After Verification:** The scanner checks the integrity of all Industrial 25 barcodes to verify that the data complies with the check character algorithm. Barcodes passing the check will be transmitted except the last digit, whereas those failing it will not be transmitted.
- ✧ **Transmit Check Character After Verification:** The scanner checks the integrity of all Industrial 25 barcodes to verify that the data complies with the check character algorithm. Barcodes passing the check will be transmitted, whereas those failing it will not be transmitted.



@L25CHK0  
\*\* Disable



@L25CHK1

**Do Not Transmit Check Character After Verification**

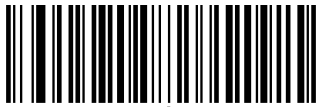

@L25CHK2

**Transmit Check Character After Verification**



If the **Do Not Transmit Check Character After Verification** option is enabled, Industrial 25 barcodes with a length that is less than the configured minimum length after having the check character excluded will not be decoded. (For example, when the **Do Not Transmit Check Character After Verification** option is enabled and the minimum length is set to 4, Industrial 25 barcodes with a total length of 4 characters including the check character cannot be read.)



@SETUPE0  
\*\* Exit Setup



@SETUPE1  
**Enter Setup**

---

## Standard 25

### Restore Factory Defaults



@S25DEF  
**Restore the Factory Defaults of Standard 25**

### Enable/Disable Standard 25



@S25ENA1  
**\*\*Enable Standard 25**



@S25ENA0  
**Disable Standard 25**



If the scanner fails to identify Standard 25 barcodes, you may first try this solution by scanning the **Enter Setup** barcode and then **Enable Standard 25** barcode.



@SETUPE0  
**\*\* Exit Setup**





@SETUPE1  
**Enter Setup**

## Set Length Range for Standard 25

The scanner can be configured to only decode Standard 25 barcodes with lengths that fall between (inclusive) the minimum and maximum lengths. To accomplish it, you need to set the minimum and maximum lengths.



@S25MIN

**Set the Minimum Length (Default: 6)**



@S25MAX

**Set the Maximum Length (Default: 48)**



If minimum length is set to be greater than maximum length, the scanner only decodes Standard 25 barcodes with either the minimum or maximum length. If minimum length is same as maximum length, only Standard 25 barcodes with that length are to be decoded.



**Set the scanner to decode Standard 25 barcodes containing between 8 and 12 characters:**

1. Scan the **Enter Setup** barcode.
2. Scan the **Set the Minimum Length** barcode.
3. Scan the numeric barcode “8” from the “Digit Barcodes” section in Appendix.
4. Scan the **Save** barcode from the “Save/Cancel Barcodes” section in Appendix.
5. Scan the **Set the Maximum Length** barcode.
6. Scan the numeric barcodes “1” and “2” from the “Digit Barcodes” section in Appendix.
7. Scan the **Save** barcode from the “Save/Cancel Barcodes” section in Appendix.
8. Scan the **Exit Setup** barcode.

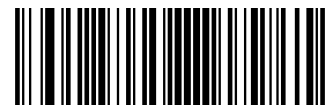

@SETUPE0  
**\*\* Exit Setup**



@SETUPE1  
Enter Setup

## Check Character Verification

A check character is optional for Standard 25 and can be added as the last character. It is a calculated value used to verify the integrity of the data.

- ✧ **Disable:** The scanner transmits Standard 25 barcodes as is.
- ✧ **Do Not Transmit Check Character After Verification:** The scanner checks the integrity of all Standard 25 barcodes to verify that the data complies with the check character algorithm. Barcodes passing the check will be transmitted except the last digit, whereas those failing it will not be transmitted.
- ✧ **Transmit Check Character After Verification:** The scanner checks the integrity of all Standard 25 barcodes to verify that the data complies with the check character algorithm. Barcodes passing the check will be transmitted, whereas those failing it will not be transmitted.



@S25CHK0  
\*\* Disable

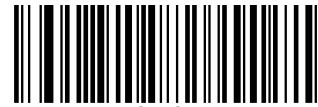

@S25CHK1

**Do Not Transmit Check Character After Verification**



@S25CHK2

**Transmit Check Character After Verification**



If the **Do Not Transmit Check Character After Verification** option is enabled, Standard 25 barcodes with a length that is less than the configured minimum length after having the check character excluded will not be decoded. (For example, when the **Do Not Transmit Check Character After Verification** option is enabled and the minimum length is set to 4, Standard 25 barcodes with a total length of 4 characters including the check character cannot be read.)



@SETUPE0  
\*\* Exit Setup



@SETUPE1  
**Enter Setup**

---

## Plessey

### Restore Factory Defaults

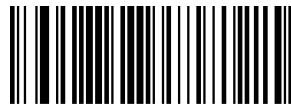

@PLYDEF

**Restore the Factory Defaults of Plessey**

### Enable/Disable Plessey



@PLYENA1

**Enable Plessey**



@PLYENA0

**\*\* Disable Plessey**



If the scanner fails to identify Plessey barcodes, you may first try this solution by scanning the **Enter Setup** barcode and then **Enable Plessey** barcode.

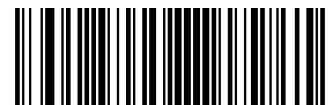

@SETUPE0  
**\*\* Exit Setup**



@SETUPE1  
Enter Setup

## Set Length Range for Plessey

The scanner can be configured to only decode Plessey barcodes with lengths that fall between (inclusive) the minimum and maximum lengths. To accomplish it, you need to set the minimum and maximum lengths.



@PLYMIN

**Set the Minimum Length (Default: 4)**



@PLYMAX

**Set the Maximum Length (Default: 48)**



If minimum length is set to be greater than maximum length, the scanner only decodes Plessey barcodes with either the minimum or maximum length. If minimum length is same as maximum length, only Plessey barcodes with that length are to be decoded.



**Set the scanner to decode Plessey barcodes containing between 8 and 12 characters:**

1. Scan the **Enter Setup** barcode.
2. Scan the **Set the Minimum Length** barcode.
3. Scan the numeric barcode “8” from the “Digit Barcodes” section in Appendix.
4. Scan the **Save** barcode from the “Save/Cancel Barcodes” section in Appendix.
5. Scan the **Set the Maximum Length** barcode.
6. Scan the numeric barcodes “1” and “2” from the “Digit Barcodes” section in Appendix.
7. Scan the **Save** barcode from the “Save/Cancel Barcodes” section in Appendix.
8. Scan the **Exit Setup** barcode.



@SETUPE0

**\*\* Exit Setup**



@SETUPE1  
Enter Setup

## Check Character Verification

Check characters are optional for Plessey and can be added as the last two characters, which are calculated values used to verify the integrity of the data.

- ✧ **Disable:** The scanner transmits Plessey barcodes as is.
- ✧ **Do Not Transmit Check Character After Verification:** The scanner checks the integrity of all Plessey barcodes to verify that the data complies with the check character algorithm. Barcodes passing the checks will be transmitted except the last two digits, whereas those failing them will not be transmitted.
- ✧ **Transmit Check Character After Verification:** The scanner checks the integrity of all Plessey barcodes to verify that the data complies with the check character algorithm. Barcodes passing the checks will be transmitted, whereas those failing them will not be transmitted.



@PLYCHK0  
**\*\* Disable**

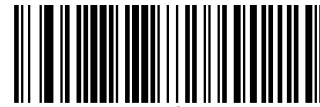

@PLYCHK1

**Do Not Transmit Check Character After Verification**



@PLYCHK2

**Transmit Check Character After Verification**



If the **Do Not Transmit Check Character After Verification** option is enabled, Plessey barcodes with a length that is less than the configured minimum length after having the check characters excluded will not be decoded. (For example, when the **Do Not Transmit Check Character After Verification** option is enabled and the minimum length is set to 4, Plessey barcodes with a total length of 4 characters including the check characters cannot be read.)



@SETUPE0  
**\*\* Exit Setup**



@SETUPE1  
Enter Setup

---

## MSI-Plessey

### Restore Factory Defaults



@MSIDF

Restore the Factory Defaults of MSI-Plessey

### Enable/Disable MSI-Plessey



@MSIENA1

Enable MSI-Plessey



@MSIENA0

\*\* Disable MSI-Plessey



If the scanner fails to identify MSI-Plessey barcodes, you may first try this solution by scanning the **Enter Setup** barcode and then **Enable MSI-Plessey** barcode.



@SETUPE0

\*\* Exit Setup



@SETUPE1  
**Enter Setup**

### Set Length Range for MSI-Plessey

The scanner can be configured to only decode MSI-Plessey barcodes with lengths that fall between (inclusive) the minimum and maximum lengths. To accomplish it, you need to set the minimum and maximum lengths.



**Set the Minimum Length (Default: 4)**



**Set the Maximum Length (Default: 48)**



If minimum length is set to be greater than maximum length, the scanner only decodes MSI-Plessey barcodes with either the minimum or maximum length. If minimum length is same as maximum length, only MSI-Plessey barcodes with that length are to be decoded.



**Set the scanner to decode MSI-Plessey barcodes containing between 8 and 12 characters:**

1. Scan the **Enter Setup** barcode.
2. Scan the **Set the Minimum Length** barcode.
3. Scan the numeric barcode “8” from the “Digit Barcodes” section in Appendix.
4. Scan the **Save** barcode from the “Save/Cancel Barcodes” section in Appendix.
5. Scan the **Set the Maximum Length** barcode.
6. Scan the numeric barcodes “1” and “2” from the “Digit Barcodes” section in Appendix.
7. Scan the **Save** barcode from the “Save/Cancel Barcodes” section in Appendix.
8. Scan the **Exit Setup** barcode.

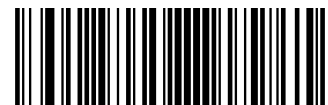

@SETUPE0  
**\*\* Exit Setup**



@SETUPE1  
**Enter Setup**

---

### Check Character Verification

Check characters are optional for MSI-Plessey and can be added as the last one or two characters, which are calculated values used to verify the integrity of the data.

If the **Disable** option is enabled, the scanner transmits MSI-Plessey barcodes as is.



@MSICLK0  
**Disable**



@MSICLK1  
**\*\* One Check Character, MOD10**



@MSICLK2  
**Two Check Characters, MOD10/MOD10**



@MSICLK3  
**Two Check Characters, MOD10/MOD11**



@SETUPE0  
**\*\* Exit Setup**





@SETUPE1  
Enter Setup

### Transmit Check Character



@MSITCK1

\*\* Transmit MSI-Plessey Check Character



@MSITCK0

Do Not Transmit MSI-Plessey Check Character



If you select a check character algorithm and the **Do Not Transmit Check Character** option, MSI-Plessey barcodes with a length that is less than the configured minimum length after having the check character(s) excluded will not be decoded. (For example, when the **One Check Character, MOD10** and **Do Not Transmit Check Character** options are enabled and the minimum length is set to 4, MSI-Plessey barcodes with a total length of 4 characters including the check character cannot be read.)



@SETUPE0  
\*\* Exit Setup



@SETUPE1  
**Enter Setup**

---

## AIM 128

### Restore Factory Defaults



@AIMDEF  
**Restore the Factory Defaults of AIM 128**

### Enable/Disable AIM 128



@AIMENA1  
**\*\* Enable AIM 128**



@AIMENA0  
**Disable AIM 128**



If the scanner fails to identify AIM 128 barcodes, you may first try this solution by scanning the **Enter Setup** barcode and then **Enable AIM 128** barcode.



@SETUPE0  
**\*\* Exit Setup**



@SETUPE1  
**Enter Setup**

## Set Length Range for AIM 128

The scanner can be configured to only decode AIM 128 barcodes with lengths that fall between (inclusive) the minimum and maximum lengths. To accomplish it, you need to set the minimum and maximum lengths.



@AIMMIN

**Set the Minimum Length (Default: 1)**



@AIMMAX

**Set the Maximum Length (Default: 48)**



If minimum length is set to be greater than maximum length, the scanner only decodes AIM 128 barcodes with either the minimum or maximum length. If minimum length is same as maximum length, only AIM 128 barcodes with that length are to be decoded.



**Set the scanner to decode AIM 128 barcodes containing between 8 and 12 characters:**

1. Scan the **Enter Setup** barcode.
2. Scan the **Set the Minimum Length** barcode.
3. Scan the numeric barcode “8” from the “Digit Barcodes” section in Appendix.
4. Scan the **Save** barcode from the “Save/Cancel Barcodes” section in Appendix.
5. Scan the **Set the Maximum Length** barcode.
6. Scan the numeric barcodes “1” and “2” from the “Digit Barcodes” section in Appendix.
7. Scan the **Save** barcode from the “Save/Cancel Barcodes” section in Appendix.
8. Scan the **Exit Setup** barcode.

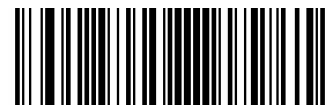

@SETUPE0  
**\*\* Exit Setup**



@SETUPE1  
Enter Setup

---

## ISBT 128

### Restore Factory Defaults



@IBTDEF  
Restore the Factory Defaults of ISBT 128

### Enable/Disable ISBT 128



@IBTENA1  
\*\* Enable ISBT 128



@IBTENA0  
Disable ISBT 128



If the scanner fails to identify ISBT 128 barcodes, you may first try this solution by scanning the **Enter Setup** barcode and then **Enable ISBT 128** barcode.



@SETUPE0  
\*\* Exit Setup



@SETUPE1  
**Enter Setup**

---

## COOP 25

### Restore Factory Defaults



@COPDEF

**Restore the Factory Defaults of COOP 25**

### Enable/Disable COOP 25



@COPENA1

**Enable COOP 25**



@COPENA0

**\*\* Disable COOP 25**



If the engine fails to identify COOP 25 barcodes, you may first try this solution by scanning the **Enter Setup** barcode and then **Enable COOP 25** barcode.

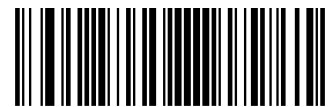

@SETUPE0  
**\*\* Exit Setup**



@SETUPE1  
Enter Setup

## Set Length Range for COOP 25

The engine can be configured to only decode COOP 25 barcodes with lengths that fall between (inclusive) the minimum and maximum lengths. To accomplish it, you need to set the minimum and maximum lengths.



@COPMIN

**Set the Minimum Length (Default: 4)**



@COPMAX

**Set the Maximum Length (Default: 80)**



If minimum length is set to be greater than maximum length, the engine only decodes COOP 25 barcodes with either the minimum or maximum length. If minimum length is same as maximum length, only COOP 25 barcodes with that length are to be decoded.



**Set the engine to decode COOP 25 barcodes containing between 8 and 12 characters:**

1. Scan the **Enter Setup** barcode.
2. Scan the **Set the Minimum Length** barcode.
3. Scan the numeric barcode "8" from the "Digit Barcodes" section in Appendix.
4. Scan the **Save** barcode from the "Save/Cancel Barcodes" section in Appendix.
5. Scan the **Set the Maximum Length** barcode.
6. Scan the numeric barcodes "1" and "2" from the "Digit Barcodes" section in Appendix.
7. Scan the **Save** barcode from the "Save/Cancel Barcodes" section in Appendix.
8. Scan the **Exit Setup** barcode.



@SETUPE0

**\*\* Exit Setup**



@SETUPE1  
**Enter Setup**

---

### Check Character Verification



@COPCHK0  
**\*\* Disable**

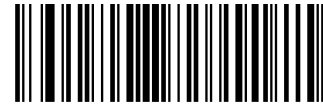

@COPCHK1  
**Do Not Transmit Check Character After Verification**



@COPCHK2  
**Transmit Check Character After Verification**

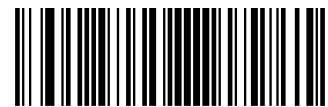

@SETUPE0  
**\*\* Exit Setup**



@SETUPE1  
**Enter Setup**

---

## PDF417

### Restore Factory Defaults



@PDFDEF  
**Restore the Factory Defaults of PDF417**

### Enable/Disable PDF417

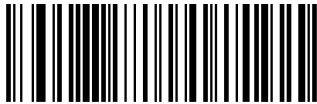

@PDFENA1  
**Enable PDF417**

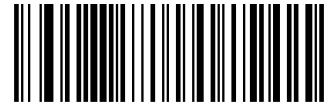

@PDFENA0  
**\*\* Disable PDF417**



If the scanner fails to identify PDF417 barcodes, you may first try this solution by scanning the **Enter Setup** barcode and then **Enable PDF417** barcode.



@SETUPE0  
**\*\* Exit Setup**





@SETUPE1  
**Enter Setup**

## Set Length Range for PDF417

The scanner can be configured to only decode PDF417 barcodes with lengths that fall between (inclusive) the minimum and maximum lengths. To accomplish it, you need to set the minimum and maximum lengths.



**Set the Minimum Length (Default: 1)**



**Set the Maximum Length (Default: 2710)**



Minimum length is not allowed to be greater than maximum length. If you only want to read PDF417 barcodes with a specific length, set both minimum and maximum lengths to be that desired length.

**E**  
*xample*

**Set the scanner to decode PDF417 barcodes containing between 8 and 12 characters:**

1. Scan the **Enter Setup** barcode.
2. Scan the **Set the Minimum Length** barcode.
3. Scan the numeric barcode “8” from the “Digit Barcodes” section in Appendix.
4. Scan the **Save** barcode from the “Save/Cancel Barcodes” section in Appendix.
5. Scan the **Set the Maximum Length** barcode.
6. Scan the numeric barcodes “1” and “2” from the “Digit Barcodes” section in Appendix.
7. Scan the **Save** barcode from the “Save/Cancel Barcodes” section in Appendix.
8. Scan the **Exit Setup** barcode.

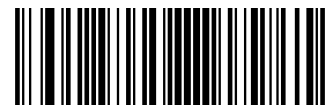

@SETUPE0  
**\*\* Exit Setup**



@SETUPE1  
Enter Setup

---

## PDF417 Twin Code

PDF417 twin code is 2 PDF417 barcodes paralleled vertically or horizontally. They must both be either regular or inverse barcodes. They must have similar specifications and be placed closely together.

There are 3 options for reading PDF417 twin codes:

- ◇ **Single PDF417 Only:** Read either PDF417 code.
- ◇ **Twin PDF417 Only:** Read both PDF417 codes.
- ◇ **Both Single & Twin:** Read both PDF417 codes. If successful, transmit as twin PDF417 only. Otherwise, try single PDF417 only.



@PDFDOU0  
**\*\* Single PDF417 Only**



@PDFDOU1  
**Twin PDF417 Only**



@PDFDOU2  
**Both Single & Twin**



@SETUPE0  
**\*\* Exit Setup**



@SETUPE1  
Enter Setup

### PDF417 Inverse

Regular barcode: Dark bars on a bright background.

Inverse barcode: Bright bars on a dark background.



@PDFINV0

**Decode Regular PDF417 Barcodes Only**



@PDFINV1

**Decode Inverse PDF417 Barcodes Only**



@PDFINV2

**\*\* Decode Both**

### Character Encoding



@PDFENC0

**\*\* Default Character Encoding**

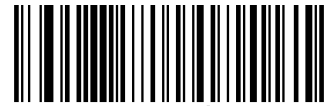

@PDFENC1

**UTF-8**



@PDFENC2

**Automatically Select UTF-8 or Code Page**

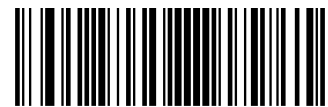

@SETUPE0  
**\*\* Exit Setup**



@SETUPE1

**Enter Setup**

---

## PDF417 ECI Output



@PDFECI0

**Disable PDF417 ECI Output**



@PDFECI1

**\*\* Enable PDF417 ECI Output**



@SETUPE0

**\*\* Exit Setup**



@SETUPE1  
**Enter Setup**

---

## QR Code

### Restore Factory Defaults



@QRCDEF

**Restore the Factory Defaults of QR Code**

### Enable/Disable QR Code



@QRCENA1

**Enable QR Code**



@QRCENA0

**\*\* Disable QR Code**



If the scanner fails to identify QR Code barcodes, you may first try this solution by scanning the **Enter Setup** barcode and then **Enable QR Code** barcode.

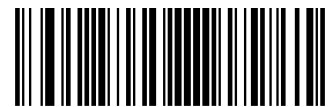

@SETUPE0  
**\*\* Exit Setup**



@SETUPE1  
Enter Setup

## Set Length Range for QR Code

The scanner can be configured to only decode QR Code barcodes with lengths that fall between (inclusive) the minimum and maximum lengths. To accomplish it, you need to set the minimum and maximum lengths.



@QRCEMIN

**Set the Minimum Length (Default: 1)**



@QRCEMAX

**Set the Maximum Length (Default: 6144)**



Minimum length is not allowed to be greater than maximum length. If you only want to read QR Code barcodes with a specific length, set both minimum and maximum lengths to be that desired length.

**E**  
*example*

**Set the scanner to decode QR Code barcodes containing between 8 and 12 characters:**

1. Scan the **Enter Setup** barcode.
2. Scan the **Set the Minimum Length** barcode.
3. Scan the numeric barcode "8" from the "Digit Barcodes" section in Appendix.
4. Scan the **Save** barcode from the "Save/Cancel Barcodes" section in Appendix.
5. Scan the **Set the Maximum Length** barcode.
6. Scan the numeric barcodes "1" and "2" from the "Digit Barcodes" section in Appendix.
7. Scan the **Save** barcode from the "Save/Cancel Barcodes" section in Appendix.
8. Scan the **Exit Setup** barcode.



@SETUPE0  
**\*\* Exit Setup**



@SETUPE1  
Enter Setup

### QR Inverse

Regular barcode: Dark bars on a bright background.

Inverse barcode: Bright bars on a dark background.



@QRCINV0

**Decode Regular QR Barcodes Only**



@QRCINV1

**Decode Inverse QR Barcodes Only**



@QRCINV2

**\*\* Decode Both**

### Character Encoding



@QRCENC0

**\*\* Default Character Encoding**



@QRCENC1

**UTF-8**



@QRCENC3

**Automatically Select UTF-8 or Code Page**



@SETUPE0  
**\*\* Exit Setup**



@SETUPE1  
**Enter Setup**

---

## QR ECI Output



@QRCECI0  
**\*\* Disable QR ECI Output**



@QRCECI1  
**Enable QR ECI Output**



@SETUPE0  
**\*\* Exit Setup**





@SETUPE1  
**Enter Setup**

## Aztec

### Restore Factory Defaults



@AZTDEF  
**Restore the Factory Defaults of Aztec Code**

### Enable/Disable Aztec Code



@AZTENA1  
**Enable Aztec Code**



@AZTENA0  
**\*\* Disable Aztec Code**



If the scanner fails to identify Aztec Code barcodes, you may first try this solution by scanning the **Enter Setup** barcode and then **Enable Aztec Code** barcode.



@SETUPE0  
**\*\* Exit Setup**



@SETUPE1  
Enter Setup

## Set Length Range for Aztec Code

The scanner can be configured to only decode Aztec barcodes with lengths that fall between (inclusive) the minimum and maximum lengths. To accomplish it, you need to set the minimum and maximum lengths.



@AZTMIN

**Set the Minimum Length (Default: 1)**



@AZTMAX

**Set the Maximum Length (Default: 6144)**



Minimum length is not allowed to be greater than maximum length. If you only want to read Aztec barcodes with a specific length, set both minimum and maximum lengths to be that desired length.

**E**  
*sample*

**Set the scanner to decode Aztec barcodes containing between 8 and 12 characters:**

1. Scan the **Enter Setup** barcode.
2. Scan the **Set the Minimum Length** barcode.
3. Scan the numeric barcode "8" from the "Digit Barcodes" section in Appendix.
4. Scan the **Save** barcode from the "Save/Cancel Barcodes" section in Appendix.
5. Scan the **Set the Maximum Length** barcode.
6. Scan the numeric barcodes "1" and "2" from the "Digit Barcodes" section in Appendix.
7. Scan the **Save** barcode from the "Save/Cancel Barcodes" section in Appendix.
8. Scan the **Exit Setup** barcode.



@SETUPE0

**\*\* Exit Setup**



@SETUPE1  
**Enter Setup**

---

## Read Multi-barcodes on an Image

There are three options:

- ◇ **Mode 1:** Read one barcode only.
- ◇ **Mode 2:** Read fixed number of barcodes only.
- ◇ **Mode 3:** Composite Reading. Read fixed number of barcodes first. If unsuccessful, read one barcode only.



@AZTMOD1  
**\*\* Mode 1**

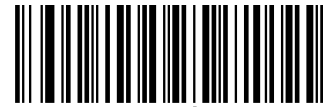

@AZTMOD2  
**Mode 2**

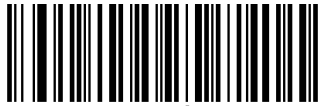

@AZTMOD3  
**Mode 3**

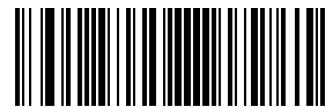

@SETUPE0  
**\*\* Exit Setup**



@SETUPE1  
Enter Setup

---

### Set the Number of Barcodes



@AZTMUL1  
\*\* 1

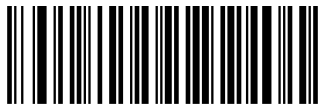

@AZTMUL3  
3

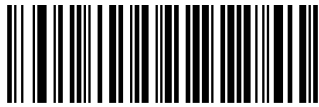

@AZTMUL5  
5

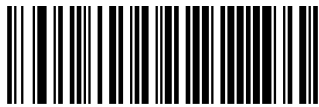

@AZTMUL7  
7



@AZTMUL2  
2



@AZTMUL4  
4



@AZTMUL6  
6



@AZTMUL8  
8



@SETUPE0  
\*\* Exit Setup



@SETUPE1  
**Enter Setup**

---

## Character Encoding



@AZTENC0

**\*\* Default Character Encoding**



@AZTENC1

**UTF-8**



@AZTENC2

**Automatically Select UTF-8 or Code Page**

## Aztec ECI Output



@AZTECI0

**\*\* Disable Aztec ECI Output**



@AZTECI1

**Enable Aztec ECI Output**



@SETUPE0  
**\*\* Exit Setup**



@SETUPE1  
Enter Setup

---

## Data Matrix

### Restore Factory Defaults



@DMCDEF  
Restore the Factory Defaults of Data Matrix

### Enable/Disable Data Matrix



@DMCENA1  
Enable Data Matrix



@DMCENA0  
\*\* Disable Data Matrix



If the scanner fails to identify Data Matrix barcodes, you may first try this solution by scanning the **Enter Setup** barcode and then **Enable Data Matrix** barcode.



@SETUPE0  
\*\* Exit Setup



@SETUPE1  
**Enter Setup**

## Set Length Range for Data Matrix

The scanner can be configured to only decode Data Matrix barcodes with lengths that fall between (inclusive) the minimum and maximum lengths. To accomplish it, you need to set the minimum and maximum lengths.



**Set the Minimum Length (Default: 1)**



**Set the Maximum Length (Default: 6144)**



Minimum length is not allowed to be greater than maximum length. If you only want to read Data Matrix barcodes with a specific length, set both minimum and maximum lengths to be that desired length.



**Set the scanner to decode Data Matrix barcodes containing between 8 and 12 characters:**

1. Scan the **Enter Setup** barcode.
2. Scan the **Set the Minimum Length** barcode.
3. Scan the numeric barcode “8” from the “Digit Barcodes” section in Appendix.
4. Scan the **Save** barcode from the “Save/Cancel Barcodes” section in Appendix.
5. Scan the **Set the Maximum Length** barcode.
6. Scan the numeric barcodes “1” and “2” from the “Digit Barcodes” section in Appendix.
7. Scan the **Save** barcode from the “Save/Cancel Barcodes” section in Appendix.
8. Scan the **Exit Setup** barcode.



@SETUPE0  
**\*\* Exit Setup**



@SETUPE1  
Enter Setup

---

### Data Matrix Twin Code

Data Matrix twin code is 2 Data Matrix barcodes paralleled vertically or horizontally. They must both be either regular or inverse barcodes. They must have similar specifications and be placed closely together.

There are 3 options for reading Data Matrix twin codes:

- ✧ **Single Data Matrix Only:** Read either Data Matrix code.
- ✧ **Twin Data Matrix Only:** Read both Data Matrix codes. Transmission sequence: left (upper) Data Matrix code followed by right (lower) Data Matrix code.
- ✧ **Both Single & Twin:** Read both Data Matrix codes. If successful, transmit as twin Data Matrix only. Otherwise, try single Data Matrix only.



@DMCDOU0  
**\*\* Single Data Matrix Only**



@DMCDOU1  
**Twin Data Matrix Only**



@DMCDOU2  
**Both Single & Twin**



@SETUPE0  
**\*\* Exit Setup**





@SETUPE1

**Enter Setup**

## Rectangular Barcode

Data Matrix has two formats:

Square barcodes having the same amount of modules in length and width: 10\*10, 12\*12.... 144\*144.

Rectangular barcodes having different amounts of models in length and width: 6\*16, 6\*14...14\*22.



@DMCREC1

**Enable Rectangular Barcode**



@DMCREC0

**\*\* Disable Rectangular Barcode**

## Data Matrix Inverse

Regular barcode: Dark bars on a bright background.

Inverse barcode: Bright bars on a dark background.



@DMCINV0

**Decode Regular Data Matrix Barcodes Only**



@DMCINV1

**Decode Inverse Data Matrix Barcodes Only**



@DMCINV2

**\*\* Decode Both**



@SETUPE0

**\*\* Exit Setup**



@SETUPE1  
Enter Setup

---

## Character Encoding



@DMCENC0  
\*\* Default Character Encoding



@DMCENC1  
UTF-8



@DMCENC2  
Automatically Select UTF-8 or Code Page

## Data Matrix ECI Output



@DMCECI0  
\*\* Disable Data Matrix ECI Output



@DMCECI1  
Enable Data Matrix ECI Output



@SETUPE0  
\*\* Exit Setup



@SETUPE1  
Enter Setup

# Chapter 10 Data Formatter

## Introduction

You may use the Data Formatter to modify the scanner's output. For example, you can use the Data Formatter to insert characters at certain points in barcode data or to suppress/ replace/ send certain characters in barcode data as it is scanned. Normally, when you scan a barcode, it gets outputted automatically; however, when you create a format, you must use a "send" command (see the "Send Commands" section in this chapter) within the format programming to output data. Multiple data formats can be programmed into the scanner. The maximum size of all data formats created is 2048 characters. By default, the data formatter is disabled. Enable it when required. If you have changed data format settings, and wish to clear all formats and return to the factory defaults, scan the **Default Data Format** code below.



@DFMDEF  
Default Data Format

## Add a Data Format

Data format is used to edit barcode data. When you create a data format, you must select one of the four labels (Format\_0, Format\_1, Format\_2 and Format\_3) for your data format, specify the application scope of data format (such as barcode type and data length) and include formatter commands. Multiple data formats may be created using the same label. When scanned data does not match your data format requirements, you will hear the non-match error beep (if the non-match error beep is ON).

There are two methods to program a data format: Programming with barcodes and programming with serial commands.

### Programming with Barcodes

The following explains how to program a data format by scanning the specific barcodes. Scanning any irrelevant barcode or failing to follow the setting procedure will result in programming failure. To find the alphanumeric barcodes needed to create a data format, see the "Digit Barcodes" section in Appendix.

**Step 1:** Scan the **Enter Setup** barcode.



@SETUPE0  
\*\* Exit Setup



@SETUPE1  
**Enter Setup**

---

**Step 2:** Scan the **Add Data Format** barcode.



@DFMADD  
**Add Data Format**

**Step 3:** Select a label (Format\_0 or Format\_1 or Format\_2 or Format\_3).

Scan a numeric barcode **0** or **1** or **2** or **3** to label this data format Format\_0 or Format\_1 or Format\_2 or Format\_3.

**Step 4:** Select formatter command type.

Specify what type of formatter commands will be used. Scan a numeric barcode **6** to select formatter command type 6. (See the “Formatter Command Type 6” section in this chapter for more information)

**Step 5:** Set interface type

Scan **999** for any interface type.

**Step 6:** Set Symbology ID Number

Refer to the “Symbology ID Number” section in Appendix and find the ID number of the symbology to which you want to apply the data format. Scan three numeric barcodes for the symbology ID number. If you wish to create a data format for all symbologies, scan **999**.

**Step 7:** Set barcode data length

Specify what length of data will be acceptable for this symbology. Scan the four numeric barcodes that represent the data length. 9999 is a universal number, indicating all lengths. For example, 32 characters should be entered as 0032.

**Step 8:** Enter formatter command

Refer to the “Formatter Command Type 6” section in this chapter. Scan the alphanumeric barcodes that represent the command you need to edit data. For example, when a command is F141, you should scan F141.

**Step 9:** Scan the **Save** barcode from the “Save/Cancel Barcodes” section in Appendix to save your data format.



@SETUPE0  
**\*\* Exit Setup**



@SETUPE1  
**Enter Setup**

---

**Example:** Program a Format\_0 data format using formatter command type 6, Code 128 containing 10 characters applicable, send all characters followed by "A".

- |                                               |                                               |
|-----------------------------------------------|-----------------------------------------------|
| 1. Scan the <b>Enter Setup</b> barcode        | Enter the Setup mode                          |
| 2. Scan the <b>Add Data Format</b> barcode    | Add a data format                             |
| 3. Scan the <b>0</b> barcode                  | Select Format_0 as the label                  |
| 4. Scan the <b>6</b> barcode                  | Select formatter command type 6               |
| 5. Scan the <b>9</b> barcode three times      | All interface types applicable                |
| 6. Scan the barcodes <b>002</b>               | Only Code 128 applicable                      |
| 7. Scan the barcodes <b>0010</b>              | Only a length of 10 characters applicable     |
| 8. Scan the alphanumeric barcodes <b>F141</b> | Send all characters followed by "A" (HEX: 41) |
| 9. Scan the <b>Save</b> barcode               | Save the data format                          |

To streamline the programming process, you may as well generate a batch barcode by inputting the command (e.g. **@DFMADD069990020010F141**;) used to create a data format. See the "Use Batch Barcode" section in Chapter 9 to learn how to put a batch barcode into use.

When creating multiple data formats sharing a label, the formats are separated from each other by a vertical bar (|) in the batch command, e.g. **@DFMADD069990029999F141|069990039999F142|169990049999F143**;

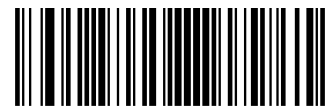

@SETUPE0  
**\*\* Exit Setup**



@SETUPE1  
Enter Setup

## Programming with Serial Commands

A data format can also be created by serial commands (HEX) sent from the host device. **All commands must be entered in uppercase letters.**

The syntax consists of the following elements:

**Prefix:** "~<SOH>0000" (HEX: **7E 01 30 30 30 30**), 6 characters.

**Storage type:** "@" (HEX: **40**) or "#" (HEX: **23**), 1 character. "@" means permanent setting which will not be lost by removing power from the scanner or rebooting it; "#" means temporary setting which will be lost by removing power from the scanner or rebooting it.

**Add Data Format Command:** "DFMADD" (HEX: **44 46 4D 41 44 44**), 6 characters.

**Data format label:** "0" (HEX: **30**) or "1" (HEX: **31**) or "2" (HEX: **32**) or "3" (HEX: **33**), 1 character. "0", "1", "2" and "3" represent Format\_0, Format\_1, Format\_2 and Format\_3 respectively.

**Formatter command type:** "6" (HEX: **36**), 1 character.

**Interface type:** "999" (HEX: **39 39 39**), 3 characters.

**Symbology ID Number:** The ID number of the symbology to which you want to apply the data format, 3 characters. 999 indicates all symbologies.

**Data length:** The length of data that will be acceptable for this symbology, 4 characters. 9999 indicates all lengths. For example, 32 characters should be entered as 0032.

**Formatter commands:** The command string used to edit data. For more information, see the "Formatter Command Type 6" section in this chapter.

**Suffix:** ";<ETX>" (HEX: **3B 03**), 2 characters.

**Example:** Program a Format\_0 data format using formatter command type 6, Code 128 containing 10 characters applicable, send all characters followed by "A".

Enter: **7E 01 30 30 30 30 40 44 46 4D 41 44 44 30 36 39 39 39 30 30 33 39 39 39 39 46 31 34 31 3B 03**  
(~<SOH>0000@DFMADD069990020010F141;<ETX>)

Response: **02 01 30 30 30 30 40 44 46 4D 41 44 44 30 36 39 39 39 30 30 33 39 39 39 39 46 31 34 31 06 3B 03**  
(<STX><SOH>0000@DFMADD069990020010F141<ACK>;<ETX>)

When creating multiple data formats sharing a label, the formats are separated from each other by a vertical bar (|) in the serial command.

**Example:** ~<SOH>0000@DFMADD069990020010F141|069990039999F142|069990049999F143;<ETX>



@SETUPE0  
\*\* Exit Setup



@SETUPE1  
Enter Setup

---

## Enable/Disable Data Formatter

When Data Formatter is disabled, the data format you have enabled becomes invalid.



\*\* Disable Data Formatter

You may wish to require the data to conform to a data format you have created. The following settings can be applied to your data format:

**Enable Data Formatter, Required, Keep Prefix/Suffix:** Scanned data that meets your data format requirements is modified accordingly and gets outputted along with prefixes and suffixes (if prefix and suffix are enabled). Any data that does not match your data format requirements generates an error beep (if Non-Match Error Beep is turned ON) and the data in that barcode is not transmitted.

**Enable Data Formatter, Required, Drop Prefix/Suffix:** Scanned data that meets your data format requirements is modified accordingly and gets outputted without prefixes and suffixes (even if prefix and suffix are enabled). Any data that does not match your data format requirements generates an error beep (if Non-Match Error Beep is turned ON) and the data in that barcode is not transmitted.

**Enable Data Formatter, Not Required, Keep Prefix/Suffix:** Scanned data that meets your data format requirements is modified accordingly and gets outputted along with prefixes and suffixes (if prefix and suffix are enabled). Barcode data that does not match your data format requirements is transmitted as read along with prefixes and suffixes (if prefix and suffix are enabled).

**Enable Data Formatter, Not Required, Drop Prefix/Suffix:** Scanned data that meets your data format requirements is modified accordingly and gets outputted without prefixes and suffixes (even if prefix and suffix are enabled). Barcode data that does not match your data format requirements is transmitted as read along with prefixes and suffixes (if prefix and suffix are enabled).

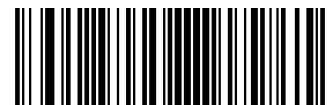

@SETUPE0  
\*\* Exit Setup



@SETUPE1  
Enter Setup

---



@DFMENA1  
Enable Data Formatter, Required, Keep Prefix/Suffix



@DFMENA2  
Enable Data Formatter, Required, Drop Prefix/Suffix



@DFMENA3  
Enable Data Formatter, Not Required, Keep  
Prefix/Suffix



@DFMENA4  
Enable Data Formatter, Not Required, Drop  
Prefix/Suffix

## Non-Match Error Beep

If Non-Match Error Beep is turned ON, the scanner generates an error beep when a barcode is encountered that does not match your required data format.

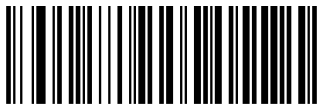

@DFMTON0  
Non-Match Error Beep Off



@DFMTON1  
\*\* Non-Match Error Beep On



@SETUPE0  
\*\* Exit Setup





@SETUPE1  
**Enter Setup**

---

## Data Format Selection

After enabling the Data Formatter, you can select a data format you want to use by scanning the appropriate barcode below.



@DFMUSE0  
**\*\* Format\_0**



@DFMUSE2  
**Format\_2**



@DFMUSE1  
**Format\_1**



@DFMUSE3  
**Format\_3**

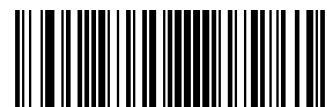

@SETUPE0  
**\*\* Exit Setup**



@SETUPE1  
Enter Setup

---

## Change Data Format for a Single Scan

You can switch between data formats for a single scan. The next barcode is scanned using the data format selected here, then reverts to the format you have selected above.

For example, you may have set your scanner to use the data format you saved as Format\_3. You can switch to Format\_1 for a single trigger pull by scanning the **Single Scan – Format\_1** barcode below. The next barcode that is scanned uses Format\_1, then reverts back to Format\_3.

Note: This setting will be lost by removing power from the scanner, or turning off/ rebooting the device.



@DFMSIN0  
**Single Scan – Format\_0**



@DFMSIN2  
**Single Scan – Format\_2**



@DFMSIN1  
**Single Scan – Format\_1**



@DFMSIN3  
**Single Scan – Format\_3**



@SETUPE0  
**\*\* Exit Setup**



@SETUPE1  
Enter Setup

---

## Clear Data Format

There are two methods to remove data format created from your scanner:

Delete one data format: Scan the **Clear One** barcode, a numeric barcode (0-3) and the **Save** barcode. For example, to delete Format\_2, you should scan the **Clear One** barcode, the **2** barcode and the **Save** barcode

Delete all data formats: Scan the **Clear All** barcode.

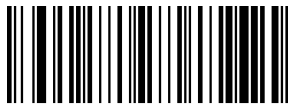

@DFMCAL  
Clear All



@DFMCLR  
Clear One

## Query Data Formats

You may scan the appropriate barcode below to get the information of data format(s) created by you or preset by manufacturer. For instance, if you have added Format\_0 as per the example in the “Add a Data Format” section in this chapter, scanning the **Query Current Data Formats** barcode, you will get the result: **Data Format0:069990020010F141;**



@DFMQCU  
Query Current Data Formats



@DFMQFA  
Query Preset Data Formats

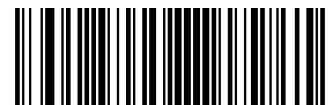

@SETUPE0  
\*\* Exit Setup



@SETUPE1  
Enter Setup

---

## Formatter Command Type 6

When working with the Data Formatter, a virtual cursor is moved along your input data string. The following commands are used to both move this cursor to different positions, and to select, replace, and insert data into the final output. For the hex value of ASCII characters involved in the commands, refer to the “ASCII Table” in Appendix.

### Send Commands

#### F1 Send all characters

Syntax=F1xx (xx: The insert character’s hex value)

Include in the output message all of the characters from the input message, starting from current cursor position, followed by an insert character.

#### F2 Send a number of characters

Syntax=F2nxx (nn: The numeric value (00-99) for the number of characters; xx: The insert character’s hex value)

Include in the output message a number of characters followed by an insert character. Start from the current cursor position and continue for “nn” characters or through the last character in the input message, followed by character “xx.”

#### F2 Example: Send a number of characters



Send the first 10 characters from the barcode above, followed by a carriage return.

Command string: **F2100D**

F2 is the “Send a number of characters” command

10 is the number of characters to send

0D is the hex value for a CR

The data is output as: **1234567890**

**<CR>**



@SETUPE0  
\*\* Exit Setup



@SETUPE1  
Enter Setup

### F3 Send all characters up to a particular character

Syntax=F3ssxx (ss: The particular character's hex value; xx: The insert character's hex value)

Include in the output message all characters from the input message, starting with the character at the current cursor position and continuing to, but not including, the particular character "ss," followed by character "xx." The cursor is moved forward to the "ss" character.

#### F3 Example: Send all characters up to a particular character



Using the barcode above, send all characters up to but not including "D," followed by a carriage return.

Command string: **F3440D**

F3 is the "Send all characters up to a particular character" command

44 is the hex value for a "D"

0D is the hex value for a CR

The data is output as: **1234567890ABC**  
**<CR>**

### E9 Send all but the last characters

Syntax=E9nn (nn: The numeric value (00-99) for the number of characters that will not be sent at the end of the message)

Include in the output message all but the last "nn" characters, starting from the current cursor position. The cursor is moved forward to one position past the last input message character included.

### F4 Insert a character multiple times

Syntax=F4xxnn (xx: The insert character's hex value; nn: The numeric value (00-99) for the number of times it should be sent)

Send "xx" character "nn" times in the output message, leaving the cursor in the current position.



@SETUPE0  
\*\* Exit Setup



@SETUPE1  
Enter Setup

---

**E9 and F4 Example: Send all but the last characters, followed by 2 tabs**



Send all characters except for the last 8 from the barcode above, followed by 2 tabs.

Command string: **E908F40902**

E9 is the “Send all but the last characters” command

08 is the number of characters at the end to ignore

F4 is the “Insert a character multiple times” command

09 is the hex value for a horizontal tab

02 is the number of time the tab character is sent

The data is output as: **1234567890AB<tab><tab>**

### **B3 Insert symbology name**

Insert the name of the barcode’s symbology in the output message, without moving the cursor.

### **B4 Insert barcode length**

Insert the barcode’s length in the output message, without moving the cursor. The length is expressed as a numeric string and does not include leading zeros.



@SETUPE0  
**\*\* Exit Setup**



@SETUPE1  
Enter Setup

### B3 and B4 Example: Insert the symbology name and length



Send the symbology name and length before the barcode data from the barcode above. Break up these insertions with spaces. End with a carriage return.

Command string: **B3F42001B4F42001F10D**

B3 is the “Insert symbology name” command

F4 is the “Insert a character multiple times” command

20 is the hex value for a space

01 is the number of time the space character is sent

B4 is the “Insert barcode length” command

F4 is the “Insert a character multiple times” command

20 is the hex value for a space

01 is the number of time the space character is sent

F1 is the “Send all characters” command

0D is the hex value for a CR

The data is output as: **Code128 20 1234567890ABCDEFGHIJ**

**<CR>**

### Move Commands

#### F5 Move the cursor forward a number of characters

Syntax=F5nn (nn: The numeric value (00-99) for the number of characters the cursor should be moved ahead)

Move the cursor ahead “nn” characters from current cursor position.

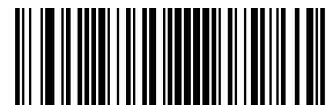

@SETUPE0  
\*\* Exit Setup



@SETUPE1  
Enter Setup

---

#### **F5 Example: Move the cursor forward and send the data**



Move the cursor forward 3 characters, then send the rest of the barcode data from the barcode above. End with a carriage return.

Command string: **F503F10D**

F5 is the “Move the cursor forward a number of characters” command

03 is the number of characters to move the cursor

F1 is the “Send all characters” command

0D is the hex value for a CR

The data is output as: **4567890ABCDEFGHIJ**

**<CR>**

#### **F6 Move the cursor backward a number of characters**

Syntax=F6nn (nn: The numeric value (00-99) for the number of characters the cursor should be moved back)

Move the cursor back “nn” characters from current cursor position.

#### **F7 Move the cursor to the beginning**

Syntax=F7

Move the cursor to the first character in the input message.

#### **EA Move the cursor to the end**

Syntax=EA

Move the cursor to the last character in the input message.



@SETUPE0  
**\*\* Exit Setup**





@SETUPE1  
Enter Setup

---

## Search Commands

### F8 Search forward for a character

Syntax=F8xx (xx: The search character's hex value)

Search the input message forward for "xx" character from the current cursor position, leaving the cursor pointing to the "xx" character.

### F8 Example: Send barcode data that starts after a particular character



Search for the letter "D" in barcodes and send all the data that follows, including the "D". Using the barcode above:

Command string: **F844F10D**

F8 is the "Search forward for a character" command

44 is the hex value for "D"

F1 is the "Send all characters" command

0D is the hex value for a CR

The data is output as: **DEFGHIJ**

**<CR>**

### F9 Search backward for a character

Syntax=F9xx(xx: The search character's hex value)

Search the input message backward for "xx" character from the current cursor position, leaving the cursor pointing to the "xx" character.

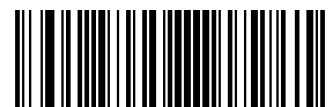

@SETUPE0  
\*\* Exit Setup



@SETUPE1  
Enter Setup

---

### B0 Search forward for a string

Syntax=B0nnnnS (nnnn: The string length (up to 9999); S: The ASCII hex value of each character in the string)

Search forward for “S” string from the current cursor position, leaving cursor pointing to “S” string. For example, B0000454657374 will search forward for the first occurrence of the 4-character string “Test.”

### B0 Example: Send barcode data that starts after a string of characters



Search for the letters “FGH” in barcodes and send all the data that follows, including “FGH.” Using the barcode above:

Command string: **B00003464748F10D**

B0 is the “Search forward for a string” command

0003 is the string length (3 characters)

46 is the hex value for “F”

47 is the hex value for “G”

48 is the hex value for “H”

F1 is the “Send all characters” command

0D is the hex value for a CR

The data is output as: **FGHIJ**

**<CR>**

### B1 Search backward for a string

Syntax=B1nnnnS (nnnn: The string length (up to 9999); S: The ASCII hex value of each character in the string)

Search backward for “S” string from the current cursor position, leaving cursor pointing to “S” string. For example, B1000454657374 will search backward for the first occurrence of the 4-character string “Test.”



@SETUPE0  
\*\* Exit Setup



@SETUPE1  
Enter Setup

---

### E6 Search forward for a non-matching character

Syntax=E6xx (xx: The search character's hex value)

Search the input message forward for the first non-“xx” character from the current cursor position, leaving the cursor pointing to the non-“xx” character.

#### E6 Example: Remove zeros at the beginning of barcode data



This example shows a barcode that has been zero filled. You may want to ignore the zeros and send all the data that follows. E6 searches forward for the first character that is not zero, then sends all the data after, followed by a carriage return. Using the barcode above:

Command string: **E630F10D**

E6 is the “Search forward for a non-matching character” command

30 is the hex value for 0

F1 is the “Send all characters” command

0D is the hex value for a CR

The data is output as: **37692**

**<CR>**

### E7 Search backward for a non-matching character

Syntax=E7xx(xx: The search character's hex value)

Search the input message backward for the first non-“xx” character from the current cursor position, leaving the cursor pointing to the non-“xx” character.

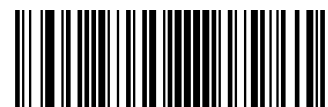

@SETUPE0  
\*\* Exit Setup



@SETUPE1  
Enter Setup

---

## Miscellaneous Commands

### FB Suppress characters

Syntax = FBnnxyy..zz (nn: The numeric value (00-15) for the number of suppressed characters; xyy..zz: The hex value of the characters to be suppressed)

Suppress all occurrences of up to 15 different characters, starting at the current cursor position, as the cursor is advanced by other commands.

#### FB Example: Remove spaces in barcode data



This example shows a barcode that has spaces in the data. You may want to remove the spaces before sending the data. Using the barcode above:

Command string: **FB0120F10D**

FB is the "Suppress characters" command

01 is the number of the characters to be suppressed

20 is the hex value for a space

F1 is the "Send all characters" command

0D is the hex value for a CR

The data is output as: **34567890**

**<CR>**

### E4 Replace characters

Syntax = E4nnxx<sub>1</sub>xx<sub>2</sub>yy<sub>1</sub>yy<sub>2</sub>...zz<sub>1</sub>zz<sub>2</sub>(nn: The total count of the number of characters (characters to be replaced plus replacement characters; xx<sub>1</sub>: The characters to be replaced, xx<sub>2</sub>: The replacement characters, continuing through zz<sub>1</sub> and zz<sub>2</sub>)

Replace up to 15 characters in the output message, without moving the cursor.



@SETUPE0  
**\*\* Exit Setup**



@SETUPE1  
Enter Setup

---

#### E4 Example: Replace zeros with CRs in barcode data



If the barcode has characters that the host application does not want included, you can use the E4 command to replace those characters with something else. In this example, you will replace the zeros in the barcode above with carriage returns.

Command string: **E402300DF10D**

E4 is the "Replace characters" command

02 is the total count of characters to be replaced, plus the replacement characters (0 is replaced by CR, so total characters=2)

30 is the hex value for 0

0D is the hex value for a CR (the character that will replace the 0)

F1 is the "Send all characters" command

0D is the hex value for a CR

The data is output as: **1234**

**5678**

**ABC**

**<CR>**



@SETUPE0  
\*\* Exit Setup



@SETUPE1  
Enter Setup

---

### BA Replace a string with another

Syntax = BAnnNN<sub>1</sub>SS<sub>1</sub>NN<sub>2</sub>SS<sub>2</sub>

nn: The count of replacements to be made, if nn=00 or nn>=the number of occurrences of a string to be replaced, then replace all occurrences of that string.

NN<sub>1</sub>: The length of the string to be replaced, NN<sub>1</sub>>0.

SS<sub>1</sub>: The ASCII hex value of each character in the string to be replaced.

NN<sub>2</sub>: The length of replacement string, NN<sub>2</sub>>=0. To replace string “SS<sub>1</sub>” with NUL (i.e. delete string “SS<sub>1</sub>”), you should set NN<sub>2</sub> to 00 and leave out SS<sub>2</sub>.

SS<sub>2</sub>: The ASCII hex value of each character in the replacement string.

From the current cursor position, search forward for the occurrence of “SS<sub>1</sub>” string (of length “NN<sub>1</sub>”) and replace the string with “SS<sub>2</sub>” string (of length “NN<sub>2</sub>”) in the output message until every “SS<sub>1</sub>” string is replaced or the count of replacements made reaches “nn” times, without moving the cursor.

### BA Example: Replace “23”s with “ABC”s in barcode data



cd123abc23bc12ab232

If the barcode has a string of characters that the host application does not want included, you can use the BA command to replace the string with something else. In this example, you will replace the “23”s in the barcode above with “ABC”s.

Command string: **BA0002323303414243F100**

BA is the “Replace a string with another” command

00 is the count of replacements to be made, 00 means to replace all occurrences of that string

02 is the length of the string to be replaced



@SETUPE0  
\*\* Exit Setup



@SETUPE1  
Enter Setup

---

32 is the hex value for 2 (character in the string to be replaced)

33 is the hex value for 3 (character in the string to be replaced)

03 is the length of the replacement string

41 is the hex value for A (character in the replacement string)

42 is the hex value for B (character in the replacement string)

43 is the hex value for C (character in the replacement string)

F1 is the "Send all characters" command

00 is the hex value for a NUL

The data is output as: **cd1ABCabcABCbc12abABC2**

#### **BA Example: Remove only the first occurrence of "23"s in barcode data**

If the barcode has a string of characters that the host application wants removed, you can use the BA command to replace the string with NUL. In this example, you will remove the first occurrence of "23" in the barcode above.

Command string: **BA0102323300F100**

BA is the "Replace a string with another" command

01 is the count of replacements to be made

02 is the length of the string to be replaced

32 is the hex value for 2 (character in the string to be replaced)

33 is the hex value for 3 (character in the string to be replaced)

00 is the length of the replacement string, 00 means to replace the string to be replaced with NUL

F1 is the "Send all characters" command

00 is the hex value for a NUL

The data is output as: **cd1abc23bc12ab232**

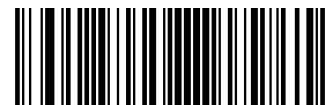

@SETUPE0  
\*\* Exit Setup



@SETUPE1  
**Enter Setup**

---

### **EF Insert a delay**

Syntax = EFnnnn (nnnn: The delay in 5ms increments, up to 9999)

Inserts a delay of up to 49,995 milliseconds (in multiples of 5), starting from the current cursor position. This command can only be used with USB HID Keyboard.

### **EF Example: Insert a delay of 1s between the 5<sup>th</sup> and 6<sup>th</sup> character**

Send the first 5 characters in a barcode, wait for 1s, then send the rest of the barcode data.

Command string: **F20500EF0200E900**

F2 is the "Send a number of characters" command

05 is the number of characters to send

00 is the hex value for a Null character

EF is the "Insert a delay" command

0200 is the delay value (5msX200=1000ms=1s)

E9 is the "Send all but the last characters" command

00 is the number of characters that will not be sent at the end of the message



@SETUPE0  
**\*\* Exit Setup**





@SETUPE1  
Enter Setup

### B5 Insert key strokes

Syntax=B5nnssxx (nn: The number of keys pressed (without key modifiers); ss: the key modifier from the table below; xx: the key number from the “Unicode Key Maps” in Appendix.)

Insert a key stroke or combination of key strokes. Key strokes are dependent on your keyboard (see the “Unicode Key Maps” in Appendix). This command can only be used with USB HID Keyboard.

Key Modifiers	
No Key Modifier	00
Shift Left	01
Shift Right	02
Alt Left	04
Alt Right	08
Control Left	10
Control Right	20

For example, B501001F inserts an “a” on a U.S. style keyboard. B5 = the command, 01 = number of keys pressed (without the key modifier), 00 is No Key Modifier, and 1F is the “a” key. If an “A” were to be inserted, B501011F or B501021F would be entered.

If there are two keystrokes, the syntax would change from Syntax=B5nnssxx for one keystroke to Syntax=B5nnssxxssxx. An example that would insert “aA” is as follows: B502001F011F.

Note: Key modifiers can be added together when needed. Example: Shift Left + Alt Left + Control Left =15.



@SETUPE0  
\*\* Exit Setup



@SETUPE1  
Enter Setup

## Chapter 11 Prefix & Suffix

### Introduction

A 1D barcode could contain digits, letters, symbols, etc. A 2D barcode could contain more data, such as Chinese characters and other multi-byte characters. However, in real applications, they do not and should not have all information we need, such as barcode type, data acquisition time and delimiter, in order to keep the barcodes short and flexible.

Prefix and suffix are how to fulfill the needs mentioned above. They can be added, removed and modified while the original barcode data remains intact.



Barcode processing procedure:

1. Edit data with Data Formatter
2. Append prefix/suffix
3. Pack data
4. Append terminating character



@SETUPE0  
\*\* Exit Setup



@SETUPE1  
Enter Setup

## Global Settings

### Enable/Disable All Prefixes/Suffixes

**Disable All Prefixes/Suffixes:** Transmit barcode data with no prefix/suffix.

**Enable All Prefixes/Suffixes:** Allow to append Code ID prefix, AIM ID prefix, custom prefix/suffix and terminating character to the barcode data before the transmission.



\*\* Disable All Prefixes/Suffixes



Enable All Prefixes/Suffixes

## Prefix Sequence



\*\* Code ID+ Custom +AIM ID



Custom + Code ID + AIM ID

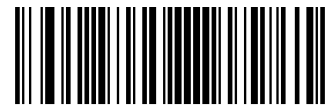

@SETUPE0  
\*\* Exit Setup



@SETUPE1  
Enter Setup

## Custom Prefix

### Enable/Disable Custom Prefix

If custom prefix is enabled, you are allowed to append to the data a user-defined prefix that cannot exceed 10 characters. For example, if the custom prefix is “AB” and the barcode data is “123”, the Host will receive “AB123”.



@CPRENA0  
**\*\* Disable Custom Prefix**



@CPRENA1  
**Enable Custom Prefix**

### Set Custom Prefix

To set a custom prefix, scan the **Set Custom Prefix** barcode then the numeric barcodes corresponding to the hexadecimal value of a desired prefix then the **Save** barcode.

**Note:** A custom prefix cannot exceed 10 characters.



@CPRSET  
**Set Custom Prefix**

**E**  
*xample*

**Set the custom prefix to “CODE” (HEX: 0x43/0x4F/0x44/0x45):**

1. Scan the **Enter Setup** barcode.
2. Scan the **Set Custom Prefix** barcode.
3. Scan the numeric barcodes “4”, “3”, “4”, “F”, “4”, “4”, “4” and “5” from the “Digit Barcodes” section in Appendix.
4. Scan the **Save** barcode from the “Save/Cancel Barcodes” section in Appendix.
5. Scan the **Enable Custom Prefix** barcode.
6. Scan the **Exit Setup** barcode.



@SETUPE0  
**\*\* Exit Setup**



@SETUPE1  
**Enter Setup**

---

## AIM ID Prefix

AIM (Automatic Identification Manufacturers) ID defines symbology identifier (For the details, see the “AIM ID Table” section in Appendix). If AIM ID prefix is enabled, the scanner will add the symbology identifier before the scanned data after decoding.



@AIDENA0  
**\*\* Disable AIM ID Prefix**



@AIDENA1  
**Enable AIM ID Prefix**



AIM ID is not user programmable.

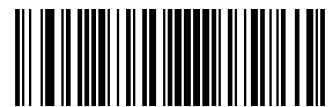

@SETUPE0  
**\*\* Exit Setup**



@SETUPE1  
**Enter Setup**

---

## Code ID Prefix

Code ID can also be used to identify barcode type. Unlike AIM ID, Code ID is user programmable. Code ID can only consist of one or two English letters.



@CIDENA0  
**\*\* Disable Code ID Prefix**



@CIDENA1  
**Enable Code ID Prefix**

## Restore All Default Code IDs

For the information of default Code IDs, see the "Code ID Table" section in Appendix.



@CIDDEF  
**Restore All Default Code IDs**

## Modify Code ID

See the examples below to learn how to modify a Code ID and restore the default Code IDs of all symbologies.



@SETUPE0  
**\*\* Exit Setup**



@SETUPE1  
**Enter Setup**

---

**E**  
*sample*

**Modify PDF417 Code ID to be “p” (HEX: 0x70):**

1. Scan the **Enter Setup** barcode.
2. Scan the **Modify PDF417 Code ID** barcode.
3. Scan the numeric barcodes “7” and “0” from the “Digit Barcodes” section in Appendix.
4. Scan the **Save** barcode from the “Save/Cancel Barcodes” section in Appendix.
5. Scan the **Exit Setup** barcode.

**Restore the default Code IDs of all symbologies:**

1. Scan the **Enter Setup** barcode.
2. Scan the **Restore All Default Code IDs** barcode.
3. Scan the **Exit Setup** barcode.

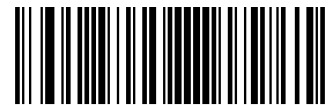

@SETUPE0  
**\*\* Exit Setup**



@SETUPE1  
**Enter Setup**

---

**1D symbologies:**



@CID002  
**Modify Code 128 Code ID**



@CID004  
**Modify EAN-8 Code ID**



@CID006  
**Modify UPC-E Code ID**



@CID008  
**Modify Interleaved 2 of 5 Code ID**



@CID003  
**Modify GS1-128 Code ID**



@CID005  
**Modify EAN-13 Code ID**



@CID007  
**Modify UPC-A Code ID**



@SETUPE0  
**\*\* Exit Setup**





@SETUPE1

**Enter Setup**

---



@CID009

**Modify ITF-14 Code ID**



@CID010

**Modify ITF-6 Code ID**



@CID011

**Modify Matrix 2 of 5 Code ID**



@CID013

**Modify Code 39 Code ID**



@CID015

**Modify Codabar Code ID**



@CID017

**Modify Code 93 Code ID**



@CID019

**Modify China Post 25 Code ID**



@CID020

**Modify AIM 128 Code ID**



@SETUPE0

**\*\* Exit Setup**



@SETUPE1  
**Enter Setup**

---



@CID022  
**Modify COOP 25 Code ID**



@CID024  
**Modify ISBN Code ID**



@CID026  
**Modify Standard 25 Code ID**



@CID028  
**Modify Code 11 Code ID**



@CID021  
**Modify ISBT 128 Code ID**



@CID023  
**Modify ISSN Code ID**



@CID025  
**Modify Industrial 25 Code ID**



@CID027  
**Modify Plessey Code ID**



@SETUPE0  
**\*\* Exit Setup**



@SETUPE1

**Enter Setup**

---



@CID029

**Modify MSI-Plessy Code ID**



@CID030

**Modify GS1 Composite Code ID**



@CID031

**Modify GS1 Databar Code ID**



@SETUPE0

**\*\* Exit Setup**



@SETUPE1  
**Enter Setup**

---

**2D symbologies:**



@CID032  
**Modify PDF417 Code ID**



@CID034  
**Modify Aztec Code ID**



@CID033  
**Modify QR Code ID**



@CID035  
**Modify Data Matrix Code ID**



@SETUPE0  
**\*\* Exit Setup**



@SETUPE1  
Enter Setup

## Custom Suffix

### Enable/Disable Custom Suffix

If custom suffix is enabled, you are allowed to append to the data a user-defined suffix that cannot exceed 10 characters. For example, if the custom suffix is “AB” and the barcode data is “123”, the Host will receive “123AB”.



@CSUENA0  
\*\* Disable Custom Suffix



@CSUENA1  
Enable Custom Suffix

### Set Custom Suffix

To set a custom suffix, scan the **Set Custom Suffix** barcode then the numeric barcodes corresponding to the hexadecimal value of a desired suffix then the **Save** barcode.

**Note:** A custom suffix cannot exceed 10 characters.



@CSUSET  
Set Custom Suffix

**E**  
*sample*

**Set the custom suffix to “CODE” (HEX: 0x43/0x4F/0x44/0x45):**

1. Scan the **Enter Setup** barcode.
2. Scan the **Set Custom Suffix** barcode.
3. Scan the numeric barcodes “4”, “3”, “4”, “F”, “4”, “4”, “4” and “5” from the “Digit Barcodes” section in Appendix.
4. Scan the **Save** barcode from the “Save/Cancel Barcodes” section in Appendix.
5. Scan the **Enable Custom Suffix** barcode.
6. Scan the **Exit Setup** barcode.

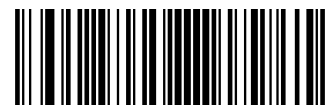

@SETUPE0  
\*\* Exit Setup



@SETUPE1  
Enter Setup

---

## Data Packing

### Introduction

Data packing is designed for a specific group of users who want to have the data packed before transmission. Data packing influences data format, so it is advised to disable this feature when it is not required.

### Data Packing Options

- ✧ **Disable Data Packing:** Transmit decoded data in raw format (unpacked).
- ✧ **Enable Data Packing, Format 1:** Transmit decoded data with the packet format 1 defined below.  
Packet format 1: [STX + ATTR + LEN] + [AL\_TYPE + DATA] + [LRC]  
STX: 0x02  
ATTR: 0x00  
LEN: Barcode data length is expressed in 2 bytes ranging from 0x0000 (0) to 0xFFFF (65535).  
AL\_TYPE: 0x36  
DATA: Raw barcode data.  
LRC: Check digit.  
LRC calculation algorithm: computation sequence: 0xFF+LEN+AL\_TYPE+DATA; computation method is XOR, byte by byte.
- ✧ **Enable Data Packing, Format 2:** Transmit decoded data with the packet format 2 defined below.  
Packet format 2: [STX + ATTR + LEN] + [AL\_TYPE] + [Symbology\_ID + DATA] + [LRC]  
STX: 0x02  
ATTR: 0x00  
LEN: Barcode data length is expressed in 2 bytes ranging from 0x0000 (0) to 0xFFFF (65535).  
AL\_TYPE: 0x3B  
Symbology\_ID: The ID number of symbology, 1 byte.  
DATA: Raw barcode data.  
LRC: Check digit.  
LRC calculation algorithm: computation sequence: 0xFF+LEN+AL\_TYPE+Symbology\_ID+DATA; computation method is XOR, byte by byte.



@SETUPE0  
\*\* Exit Setup



@SETUPE1  
**Enter Setup**

---



@PACKAG0  
**\*\* Disable Data Packing**



@PACKAG1  
**Enable Data Packing, Format 1**

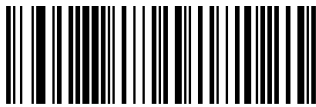

@PACKAG2  
**Enable Data Packing, Format 2**



@SETUPE0  
**\*\* Exit Setup**



@SETUPE1  
Enter Setup

---

## Terminating Character Suffix

### Enable/Disable Terminating Character Suffix

A terminating character such as carriage return (CR) or carriage return/line feed pair (CRLF) can only be used to mark the end of data, which means nothing can be added after it.



@TSUENA0

Disable Terminating Character Suffix



@TSUENA1

\*\* Enable Terminating Character Suffix

### Set Terminating Character Suffix

To set a terminating character suffix, scan the **Set Terminating Character Suffix** barcode then the numeric barcodes corresponding to the hexadecimal value of a desired terminating character then the **Save** barcode.

**Note:** A terminating character suffix cannot exceed 2 characters.



@TSUSET

Set Terminating Character Suffix



@TSUSET0D

\*\* Set Terminating Character to CR (0x0D)



@TSUSET0D0A

Set Terminating Character to CRLF (0x0D,0x0A)



@SETUPE0

\*\* Exit Setup





@SETUPE1  
**Enter Setup**

---

**E**  
*sample*

**Set the terminating character suffix to 0x0A:**

1. Scan the **Enter Setup** barcode.
2. Scan the **Set Terminating Character Suffix** barcode.
3. Scan the numeric barcodes “0” and “A” from the “Digit Barcodes” section in Appendix.
4. Scan the **Save** barcode from the “Save/Cancel Barcodes” section in Appendix.
5. Scan the **Enable Terminating Character Suffix** barcode.
6. Scan the **Exit Setup** barcode.

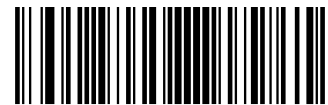

@SETUPE0  
**\*\* Exit Setup**



@SETUPE1  
Enter Setup

## Chapter 12 Batch Programming

### Introduction

Batch programming enables users to integrate a batch of commands into a single batch barcode.

Listed below are batch programming rules:

1. Command format: Command + Parameter Value.
2. Each command is terminated by a semicolon (;). Note that there is no space between a command and its terminator semicolon.
3. Use the barcode generator software to generate a 2D batch barcode.

Example: Create a batch barcode for **Illumination Always On, Sense Mode, Decode Session Timeout = 2s**:

1. Input the commands:

```
@ILLSCN2;SCNMOD2;ORTSET2000;
```

2. Generate a batch barcode.

When setting up a scanner with the above configuration, scan the **Enable Batch Barcode** barcode and then the batch barcode generated.



@BATCHS  
Enable Batch Barcode



@SETUPE0  
\*\* Exit Setup



@SETUPE1  
Enter Setup

---

## Create a Batch Command

A batch command may contain a number of individual commands each of which is terminated by a semicolon (;).

For more information, refer to the “Use of Programming Command” section in Chapter 3.

## Create a Batch Barcode

Batch barcodes can be produced in the format of PDF417, QR Code or Data Matrix.

Example: Create a batch barcode for **Illumination Always On, Sense Mode, Decode Session Timeout = 2s:**

1. Input the following commands:

```
@ILLSCN2;SCNMOD2;ORTSET2000;
```

2. Generate a PDF417 batch barcode.

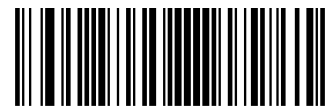

@SETUPE0  
\*\* Exit Setup



@SETUPE1  
Enter Setup

---

## Use Batch Barcode

To put a batch barcode into use, scan the following barcodes. (Use the example above.)



@SETUPE1  
Enter Setup



@BATCHS  
Enable Batch Barcode



Batch Barcode

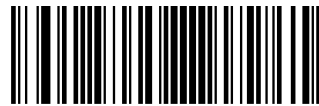

@SETUPE0  
Exit Setup



@SETUPE0  
\*\* Exit Setup



@SETUPE1  
**Enter Setup**

## Chapter 13 PS/2 Interface

### Introduction

When the scanner is connected to the PS/2 port of a host device, scan the PS/2 barcode below to enable the interface.



@INTERF4  
**PS/2**

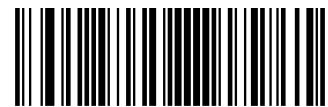

@SETUPE0  
**\*\* Exit Setup**

# Chapter 14 Handheld Barcode Scanner Access

## Introduction

This chapter provides format requirements of the input data from the handheld barcode scanner connected to the secondary RJ45 port.

1. Communication: serial port, 9600 baud rate, 8 data bits, 1 stop bit, no parity check, hardware auto flow control.
2. Data format requirements of the handheld barcode scanner ( when the barcode data is 12345).

### A, barcode data with code prefix

SETUP128/CODE128/ AIM 128/ ISBT 128: barcode data with prefix # required, the scanned data is #123456.

EAN-128: barcode data with prefix j required, the scanned data is j123456.

EAN-8: barcode data with prefix FF required, the scanned data is FF123456.

EAN-13: barcode data with prefix F required, the scanned data is F123456.

UPC-E: barcode data with prefix E required, the scanned data is E123456.

UPC-A: barcode data with prefix A required, the scanned data is A123456.

Interleaved 2 of 5: barcode data with prefix i required, the scanned data is i123456.

ITF-14/ ITF-6/ ISBN: barcode data with prefix e required, the scanned data is e123456.

Matrix 2 of 5: barcode data with prefix v required, the scanned data is v123456.

Code 39: barcode data with prefix \* required, the scanned data is \*123456.

Codabar: barcode data with prefix % required, the scanned data is %123456.

Code 93: barcode data with prefix & required, the scanned data is &123456.

China Post 25: barcode data with prefix X required, the scanned data is X123456.

ISSN: barcode data with prefix g required, the scanned data is g123456.

Industrial 25: barcode data with prefix l required, the scanned data is l123456.

Standard 25: barcode data with prefix f required, the scanned data is f123456.

Plessey: barcode data with prefix n required, the scanned data is n123456.

---

Code 11: barcode data with prefix H required, the scanned data is H123456.

MSI Plessey: barcode data with prefix @ required, the scanned data is @123456.

GS1 Composite: barcode data with prefix y required, the scanned data is y123456.

GS1 Databar(RSS) : barcode data with prefix R4 required, the scanned data is R4123456.

PDF417: barcode data with prefix P required, the scanned data is P123456.

QR Code: barcode data with prefix s required, the scanned data is s123456.

Aztec: barcode data with prefix z required, the scanned data is z123456.

Data Matrix: barcode data with prefix u required, the scanned data is u123456.

**B, barcode data with 3-bit AIMID prefix**

SETUP128/CODE128: barcode data with prefix ]C0 required, the scanned data is ]C0123456.

EAN-128: barcode data with prefix ]C1 required, the scanned data is ]C1123456.

EAN-8: barcode data with prefix ]E4 required, the scanned data is ]E4123456.

EAN-13/ UPC-A: barcode data with prefix ]E0 required, the scanned data is ]E0123456.

UPC-E: barcode data with prefix ]E3 required, the scanned data is ]E3123456.

Interleaved 2 of 5: barcode data with prefix ]I0 required, the scanned data is ]I0123456.

ITF-14: barcode data with prefix ]I1 required, the scanned data is ]I1123456.

ITF-6: barcode data with prefix ]I3 required, the scanned data is ]I3123456.

Matrix 2 of 5: barcode data with prefix ]X0 required, the scanned data is ]X0123456.

Code 39: barcode data with prefix ]A0 required, the scanned data is ]A0123456.

Codabar: barcode data with prefix ]F0 required, the scanned data is ]F0123456.

Code 93: barcode data with prefix ]G0 required, the scanned data is ]G0123456.

AIM 128: barcode data with prefix ]C2 required, the scanned data is ]C2123456.

ISBT 128: barcode data with prefix ]C4 required, the scanned data is ]C4123456.

Industrial 25: barcode data with prefix ]S0 required, the scanned data is ]S0123456.

---

---

Standard 25: barcode data with prefix ]R0 required, the scanned data is ]R0123456.

Plessey: barcode data with prefix ]P0 required, the scanned data is ]P0123456.

Code 11: barcode data with prefix ]H0 required, the scanned data is ]H0123456.

MSI Plessey: barcode data with prefix ]M0 required, the scanned data is ]M0123456.

GS1 Composite/GS1 Databar(RSS) : barcode data with prefix ]e0 required, the scanned data is ]e0123456.

PDF417: barcode data with prefix ]L0 required, the scanned data is ]L0123456.

QR Code: barcode data with prefix ]Q0 required, the scanned data is ]Q0123456.

Aztec: barcode data with prefix ]z0 required, the scanned data is ]z0123456.

Data Matrix: barcode data with prefix ]d0 required, the scanned data is ]d0123456.



# Appendix

## Digit Barcodes

0~9



@DIGIT0

0



@DIGIT2

2



@DIGIT4

4



@DIGIT1

1



@DIGIT3

3



@DIGIT5

5



@DIGIT6

**6**



@DIGIT7

**7**



@DIGIT8

**8**



@DIGIT9

**9**

---

A~F



---

## Save/Cancel Barcodes

After reading numeric barcode(s), you need to scan the **Save** barcode to save the data. If you scan the wrong digit(s), you can either scan the **Cancel** barcode and then start the configuration all over again, or scan the **Delete the Last Digit** barcode and then the correct digit, or scan the **Delete All Digits** barcode and then the digits you want.

For instance, after reading the **Maximum Length** barcode and numeric barcodes “1”, “2” and “3”, you scan:

- ✧ **Delete the Last Digit:** The last digit “3” will be removed.
- ✧ **Delete All Digits:** All digits “123” will be removed.
- ✧ **Cancel:** The maximum length configuration will be cancelled. And the scanner is still in the setup mode.



@DIGSAV

**Save**



@DIGCAN

**Cancel**



@DIGDEL

**Delete the Last Digit**



@DIGDAL

**Delete All Digits**

## Factory Defaults Table

Parameter	Factory Default	Remark
<b>System Settings</b>		
Barcode Programming	Disabled (Exit Setup)	
Programming Barcode Data	Do not transmit	
Power On Beep	On	
Good Read Beep	On	
Good Read Beep Volume	Loud	
Good Read Sound Effect	2730Hz	
Decode Session Timeout	30000ms.	1-3,600,000ms; 0: Infinite
Image Stabilization Timeout (Sense Mode)	500ms	0-3,000ms
Image Decoding Timeout	100ms	1-3,000ms
Surround GS1 Application Identifiers (AI's) with Parentheses	Do Not Surround GS1 AI's with Parentheses	
Scanning Preference	Screen Mode	
Decode Area	Whole Area Decoding	
Specify Decoding Area	40% top, 60% bottom, 40% left, 60% right	
Image Flipping	Do Not Flip	
Bad Read Message	Off	
	NG	1-7 characters
Default Interface	USB HID Keyboard	
<b>RS-232 Interface</b>		
Baud Rate	9600	
Parity Check	None	
Data Bits	8	
Stop Bits	1	
Hardware Auto Flow Control	Disabled	
<b>USB Interface</b>		
USB Country Keyboard	US keyboard	USB HID Keyboard
Beep on Unknown Character	Off	USB HID Keyboard
Emulate ALT+Keypad	Off	USB HID Keyboard
Code Page	Code Page 1252 (West European Latin)	USB HID Keyboard
Unicode Encoding	Off	USB HID Keyboard
Emulate Keypad with Leading Zero	On	USB HID Keyboard

Function Key Mapping	Disable	USB HID Keyboard
Inter-Keystroke Delay	No Delay	USB HID Keyboard
Caps Lock	Caps Lock OFF, non-Japanese Keyboard	USB HID Keyboard
Convert Case	No Case Conversion	USB HID Keyboard
Emulate Numeric Keypad 1	Off	USB HID Keyboard
Emulate Numeric Keypad 2	Off	USB HID Keyboard
Fast Mode	Off	USB HID Keyboard
Polling Rate	4ms	USB HID Keyboard
Adaptive Wired Communication	On	
<b>Symbologies</b>		
<b>Global Settings</b>		
1D Twin Code	Single 1D Code Only	
Surround GS1 AI's with Parentheses	Do Not Surround GS1 AI's with Parentheses	
<b>Code 128</b>		
Code 128	Enabled	
Maximum Length	48	
Minimum Length	1	
<b>EAN-8</b>		
EAN-8	Enabled	
Check Character	Transmit	
2-Digit Add-On Code	Disabled	
5-Digit Add-On Code	Disabled	
Add-On Code	Not Required	
Convert EAN-8 to EAN-13	Disabled	
<b>EAN-13</b>		
EAN-13	Enabled	
Check Character	Transmit	
2-Digit Add-On Code	Disabled	
5-Digit Add-On Code	Disabled	
Add-On Code	Not Required	
EAN-13 Beginning with 290 Add-On Code Required	Do Not Require Add-On Code	
EAN-13 Beginning with 378/379 Add-On Code Required	Do Not Require Add-On Code	
EAN-13 Beginning with 414/419 Add-On Code Required	Do Not Require Add-On Code	

EAN-13 Beginning with 434/439 Add-On Code Required	Do Not Require Add-On Code	
EAN-13 Beginning with 977 Add-On Code Required	Do Not Require Add-On Code	
EAN-13 Beginning with 978 Add-On Code Required	Do Not Require Add-On Code	
EAN-13 Beginning with 979 Add-On Code Required	Do Not Require Add-On Code	
<b>UPC-E</b>		
Check Character	Transmit	
2-Digit Add-On Code	Disabled	
5-Digit Add-On Code	Disabled	
Add-On Code	Not Required	
Transmit Preamble Character	System Character	
Convert UPC-E to UPC-A	Disabled	
<b>UPC-A</b>		
UPC-A	Enabled	
Check Character	Transmit	
2-Digit Add-On Code	Disabled	
5-Digit Add-On Code	Disabled	
Add-On Code	Not Required	
Transmit Preamble Character	System Character	
<b>Coupon</b>		
UPC-A/EAN-13 with Extended Coupon Code	Disabled	
Coupon GS1 DataBar Output	Disabled	
<b>Interleaved 2 of 5</b>		
Interleaved 2 of 5	Enabled	
Maximum Length	80	
Minimum Length	6	No less than 4
Check Character Verification	Disabled	
<b>Febraban</b>		
Febraban	Disabled	
Transmit Delay per Character	Disabled	
	70ms	
Transmit Delay per 12 Characters	Disabled	
	500ms	
<b>ITF-14</b>		
ITF-14	Disabled	

<b>ITF-6</b>		
ITF-6	Disabled	
<b>Matrix 2 of 5</b>		
Matrix 2 of 5	Enabled	
Maximum Length	80	
Minimum Length	4	No less than 4
Check Character Verification	Disabled	
<b>Code 39</b>		
Code 39	Enabled	
Maximum Length	48	
Minimum Length	1	
Check Character Verification	Disabled	
Start/Stop Character	Do not transmit	
Code 39 Full ASCII	Disabled	
Code 32 Pharmaceutical (PARAF)	Disabled	
Code 32 Prefix	Disabled	
Code 32 Start/Stop Character	Do not transmit	
Code 32 Check Character	Do not transmit	
<b>Codabar</b>		
Codabar	Disabled	
Maximum Length	60	
Minimum Length	2	
Check Character Verification	Disabled	
Start/Stop Character	Do not transmit	
	ABCD/ABCD	
<b>Code 93</b>		
Code 93	Disabled	
Maximum Length	48	
Minimum Length	1	No less than 1
Check Character Verification	Do Not Transmit Check Character After Verification	
<b>China Post 25</b>		
China Post 25	Disabled	
Maximum Length	48	
Minimum Length	1	



Check Character Verification	Disabled	
<b>GS1-128 (UCC/EAN-128)</b>		
GS1-128	Enabled	
Maximum Length	48	
Minimum Length	1	
<b>GS1 Databar</b>		
GS1 Databar	Enabled	
Application Identifier "01"	Transmit	
<b>EAN•UCC Composite</b>		
GS1 Composite	Enabled	
UPC/EAN Composite	Disabled	
<b>Code 11</b>		
Code 11	Disabled	
Maximum Length	48	
Minimum Length	4	No less than 4
Check Character Verification	One Check Character, MOD11	
Check Character	Transmit	
<b>ISBN</b>		
ISBN	Disabled	
Set ISBN Format	ISBN-10	
<b>ISSN</b>		
ISSN	Enabled	
<b>Industrial 25</b>		
Industrial 25	Disabled	
Maximum Length	48	
Minimum Length	6	No less than 4
Check Character Verification	Disabled	
<b>Standard 25</b>		
Standard 25	Enabled	
Maximum Length	48	
Minimum Length	6	No less than 4
Check Character Verification	Disabled	
<b>Plessey</b>		
Plessey	Disabled	
Maximum Length	48	

Minimum Length	4	No less than 4
Check Character Verification	Disabled	
<b>MSI-Plessey</b>		
MSI-Plessey	Disabled	
Maximum Length	48	
Minimum Length	4	No less than 4
Check Character Verification	One Check Character, MOD10	
Check Character	Transmit	
<b>AIM 128</b>		
AIM 128	Enabled	
Maximum Length	48	
Minimum Length	1	
<b>ISBT 128</b>		
ISBT 128	Enabled	
<b>COOP 25</b>		
COOP 25	Disabled	
Maximum Length	80	
Minimum Length	4	
Check Character Verification	Disabled	
<b>PDF417</b>		
PDF417	Disabled	
Maximum Length	2710	
Minimum Length	1	
PDF417 Twin Code	Single PDF417 Only	
PDF417 Inverse	Decode Both	
Character Encoding	Default Character Encoding	
PDF417 ECI Output	Enabled	
<b>QR Code</b>		
QR Code	Disabled	
Maximum Length	6144	
Minimum Length	1	
QR Inverse	Decode Both	
Character Encoding	Default Character Encoding	
QR ECI Output	Disabled	
<b>Aztec</b>		

Aztec Code	Disabled	
Maximum Length	6144	
Minimum Length	1	
Read Multi-barcodes on an Image	Mode 1	
Character Encoding	Default Character Encoding	
Aztec ECI Output	Disabled	
<b>Data Matrix</b>		
Data Matrix	Disabled	
Maximum Length	6144	
Minimum Length	1	
Data Matrix Twin Code	Single Data Matrix Only	
Rectangular Barcode	Disabled	
Data Matrix Inverse	Decode Both	
Character Encoding	Default Character Encoding	
Data Matrix ECI Output	Disabled	
<b>Data Formatter</b>		
Data Formatter	Disabled	
Non-Match Error Beep	On	
Data Format Selection	Format_0	
<b>Prefix &amp; Suffix</b>		
All Prefixes/Suffixes	Disabled	
Prefix Sequence	Code ID+ Custom +AIM ID	
Custom Prefix	Disabled	
AIM ID Prefix	Disabled	
Code ID Prefix	Disabled	
Custom Suffix	Disabled	
Data Packing	Disable Data Packing	
Terminating Character Suffix	Enabled (0x0D)	

## AIM ID Table

Symbology	AIM ID	Possible AIM ID Modifiers (m)
Code 128	]C0	
GS1-128 (UCC/EAN-128)	]C1	
EAN-8	]E4	
EAN-8 with Addon	]E3	
EAN-13	]E0	
EAN-13 with Addon	]E3	
UPC-E	]E0	
UPC-E with Addon	]E3	
UPC-A	]E0	
UPC-A with Addon	]E3	
Interleaved 2 of 5, Febraban	]Im	0, 1, 3
ITF-14	]Im	1, 3
ITF-6	]Im	1, 3
Matrix 2 of 5	]X0	
Code 39	]Am	0, 1, 3, 4, 5, 7
Codabar	]Fm	0, 2, 4
Code 93	]G0	
China Post 25	]X0	
AIM 128	]C2	
ISBT 128	]C4	
ISSN	]X0	
ISBN	]X0	
Industrial 25	]S0	
Standard 25	]R0	
Plessey	]P0	
Code 11	]Hm	0, 1, 3
MSI Plessey	]Mm	0, 1
GS1 Composite	]em	0-3
GS1 Databar (RSS)	]e0	
COOP 25	]X0	

---

Symbology	AIM ID	Possible AIM ID Modifiers (m)
PDF417	]Lm	0-2
QR Code	]Qm	0-6
Aztec	]zm	0-9, A-C
Data Matrix	]dm	0-6

**Note:** “m” represents the AIM modifier character. Refer to ISO/IEC 15424:2008 Information technology – Automatic identification and data capture techniques – Data Carrier Identifiers (including Symbology Identifiers) for AIM modifier character details.

---

## Code ID Table

Symbology	Code ID
Code 128	j
GS1-128 (UCC/EAN-128)	j
EAN-8	d
EAN-13	d
UPC-E	c
UPC-A	c
Interleaved 2 of 5, Febraban	e
ITF-14	e
ITF-6	e
Matrix 2 of 5	v
Code 39	b
Codabar	a
Code 93	i
China Post 25	X
AIM 128	X
ISBT 128	X
ISSN	g
ISBN	B
Industrial 25	l
Standard 25	f
Plessey	n
Code 11	H
MSI Plessey	m
GS1 Composite	y
GS1 Databar (RSS)	R
COOP 25	X
PDF417	r
QR Code	s
Aztec	z
Data Matrix	u

---

---

## Symbology ID Number

Symbology	ID Number
Code 128	002
GS1-128 (UCC/EAN-128)	003
EAN-8	004
EAN-13	005
UPC-E	006
UPC-A	007
Interleaved 2 of 5, Febraban	008
ITF-14	009
ITF-6	010
Matrix 2 of 5	011
Code 39	013
Codabar	015
Code 93	017
China Post 25	019
AIM 128	020
ISBT 128	021
COOP 25	022
ISSN	023
ISBN	024
Industrial25	025
Standard25	026
Plessey	027
Code11	028
MSI-Plessey	029
GS1 Composite	030
GS1 Databar (RSS)	031
PDF417	032
QR Code	033
Aztec	034
Data Matrix	035

---

## ASCII Table

Hex	Dec	Char
00	0	NUL (Null char.)
01	1	SOH (Start of Header)
02	2	STX (Start of Text)
03	3	ETX (End of Text)
04	4	EOT (End of Transmission)
05	5	ENQ (Enquiry)
06	6	ACK (Acknowledgment)
07	7	BEL (Bell)
08	8	BS (Backspace)
09	9	HT (Horizontal Tab)
0a	10	LF (Line Feed)
0b	11	VT (Vertical Tab)
0c	12	FF (Form Feed)
0d	13	CR (Carriage Return)
0e	14	SO (Shift Out)
0f	15	SI (Shift In)
10	16	DLE (Data Link Escape)
11	17	DC1 (XON) (Device Control 1)
12	18	DC2 (Device Control 2)
13	19	DC3 (XOFF) (Device Control 3)
14	20	DC4 (Device Control 4)
15	21	NAK (Negative Acknowledgment)
16	22	SYN (Synchronous Idle)
17	23	ETB (End of Trans. Block)
18	24	CAN (Cancel)
19	25	EM (End of Medium)
1a	26	SUB (Substitute)
1b	27	ESC (Escape)
1c	28	FS (File Separator)
1d	29	GS (Group Separator)

---



Hex	Dec	Char
1e	30	RS (Request to Send)
1f	31	US (Unit Separator)
20	32	SP (Space)
21	33	! (Exclamation Mark)
22	34	" (Double Quote)
23	35	# (Number Sign)
24	36	\$ (Dollar Sign)
25	37	% (Percent)
26	38	& (Ampersand)
27	39	` (Single Quote)
28	40	( (Left/ Opening Parenthesis)
29	41	) (Right/ Closing Parenthesis)
2a	42	* (Asterisk)
2b	43	+ (Plus)
2c	44	, (Comma)
2d	45	- (Minus/ Dash)
2e	46	. (Dot)
2f	47	/ (Forward Slash)
30	48	0
31	49	1
32	50	2
33	51	3
34	52	4
35	53	5
36	54	6
37	55	7
38	56	8
39	57	9
3a	58	: (Colon)
3b	59	; (Semi-colon)
3c	60	< (Less Than)
3d	61	= (Equal Sign)

Hex	Dec	Char
3e	62	> (Greater Than)
3f	63	? (Question Mark)
40	64	@ (AT Symbol)
41	65	A
42	66	B
43	67	C
44	68	D
45	69	E
46	70	F
47	71	G
48	72	H
49	73	I
4a	74	J
4b	75	K
4c	76	L
4d	77	M
4e	78	N
4f	79	O
50	80	P
51	81	Q
52	82	R
53	83	S
54	84	T
55	85	U
56	86	V
57	87	W
58	88	X
59	89	Y
5a	90	Z
5b	91	[ (Left/ Opening Bracket)
5c	92	\ (Back Slash)
5d	93	] (Right/ Closing Bracket)

Hex	Dec	Char
5e	94	^ (Caret/ Circumflex)
5f	95	_ (Underscore)
60	96	' (Grave Accent)
61	97	a
62	98	b
63	99	c
64	100	d
65	101	e
66	102	f
67	103	g
68	104	h
69	105	i
6a	106	j
6b	107	k
6c	108	l
6d	109	m
6e	110	n
6f	111	o
70	112	p
71	113	q
72	114	r
73	115	s
74	116	t
75	117	u
76	118	v
77	119	w
78	120	x
79	121	y
7a	122	z
7b	123	{ (Left/ Opening Brace)
7c	124	(Vertical Bar)
7d	125	} (Right/ Closing Brace)
7e	126	~ (Tilde)
7f	127	DEL (Delete)

## Unicode Key Maps

6E	70	71	72	73	74	75	76	77	78	79	7A	7B	7C	7D	7E	•	•	•		
01	02	03	04	05	06	07	08	09	0A	0B	0C	0D	0F	4B	50	55	5A	5F	64	69
10	11	12	13	14	15	16	17	18	19	1A	1B	1C	1D	4C	51	56	5B	60	65	6A
1E	1F	20	21	22	23	24	25	26	27	28	29	2B				5C	61	66		
2C	2E	2F	30	31	32	33	34	35	36	37	39			53			5D	62	67	6C
3A	3B	3C	3D					3E	3F	38	40	4F	54	59	63	68				

104 Key U.S. Style Keyboard

6E	70	71	72	73	74	75	76	77	78	79	7A	7B	7C	7D	7E	•	•	•		
01	02	03	04	05	06	07	08	09	0A	0B	0C	0D	0F	4B	50	55	5A	5F	64	69
10	11	12	13	14	15	16	17	18	19	1A	1B	1C	2B	4C	51	56	5B	60	65	6A
1E	1F	20	21	22	23	24	25	26	27	28	29	1D				5C	61	66		
2C	2D	2E	2F	30	31	32	33	34	35	36	37	39		53			5D	62	67	6C
3A	3B	3C	3D					3E	3F	38	40	4F	54	59	63	68				

105 Key European Style Keyboard



# Newland

SCANNING MADE SIMPLE

---

Newland EMEA HQ  
+31 (0) 345 87 00 33  
[info@newland-id.com](mailto:info@newland-id.com)  
[newland-id.com](http://newland-id.com)

Need more info? Contact us or one of  
our partners at [newland-id.com/partners](http://newland-id.com/partners)