

# Dell Thunderbolt Dock

WD22TB4

User Guide

## Notes, cautions, and warnings

 **NOTE:** A NOTE indicates important information that helps you make better use of your product.

 **CAUTION:** A CAUTION indicates either potential damage to hardware or loss of data and tells you how to avoid the problem.

 **WARNING:** A WARNING indicates a potential for property damage, personal injury, or death.

# Contents

<b>Chapter 1: Introduction.....</b>	<b>5</b>
<b>Chapter 2: What's in the box.....</b>	<b>6</b>
<b>Chapter 3: Hardware requirements.....</b>	<b>7</b>
<b>Chapter 4: Views of Dell Thunderbolt Dock - WD22TB4.....</b>	<b>8</b>
Top.....	8
Front.....	8
Right.....	8
Back.....	8
Bottom.....	9
<b>Chapter 5: Important Information.....</b>	<b>10</b>
<b>Chapter 6: Setting up your docking station.....</b>	<b>11</b>
<b>Chapter 7: Setup of External Monitors.....</b>	<b>13</b>
Configuring your Monitors.....	13
Video connectors for multiple display setup.....	14
Display bandwidth.....	16
Display Resolution Table.....	16
<b>Chapter 8: Replacing the USB Type-C cable module.....</b>	<b>20</b>
Upgrading your WD19 docks.....	24
<b>Chapter 9: Technical specifications.....</b>	<b>26</b>
Product specifications.....	26
Power adapter specifications.....	27
Port disablement .....	27
<b>LED Status Indicators</b> .....	<b>30</b>
<b>Power Adapter LED</b> .....	<b>30</b>
<b>Docking Status Indicator</b> .....	<b>30</b>
Dell ExpressCharge and ExpressCharge Boost overview.....	31
Docking specifications.....	31
<b>Chapter 10: Dell docking station firmware update .....</b>	<b>32</b>
<b>Chapter 11: Frequently asked questions.....</b>	<b>35</b>
<b>Chapter 12: Troubleshooting the Dell Thunderbolt Dock - WD22TB4.....</b>	<b>36</b>
Symptoms and solutions.....	36

**Chapter 13: Getting help and contacting Dell.....40**

# Introduction

The Dell Thunderbolt Dock - WD22TB4 is a device that links all your electronic devices to your system using a Thunderbolt 4 (Type-C) cable interface. Connecting the system to the docking station allows you to easily connect multiple peripherals (mouse, keyboard, stereo speakers, external hard-drives, and high-resolution displays) without having to plug each one into the system.

**CAUTION:** Update your system's BIOS, graphic drivers and the Dell Thunderbolt Dock drivers to the latest versions available at [www.dell.com/support](http://www.dell.com/support) BEFORE using the docking station. Older BIOS versions and drivers could result in your system not recognizing the docking station or not functioning optimally. Always check if any recommended firmware is available for your docking station at [www.dell.com/support](http://www.dell.com/support).

## What's in the box

Your docking station ships with the components shown below:

1. Docking station
2. Power adapter and power cord
3. Documentation (Quick Start Guide, Safety, Environmental, and Regulatory Information)

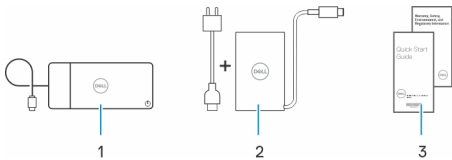

**NOTE:** Contact Dell support if any of the listed items are missing from your box.

## Hardware requirements

Before using the docking station, ensure that your system has a USB Type-C with DisplayPort Alt Mode (supported) or Thunderbolt port (recommended) over USB Type-C that is designed to support the docking station.

# Views of Dell Thunderbolt Dock - WD22TB4

## Top

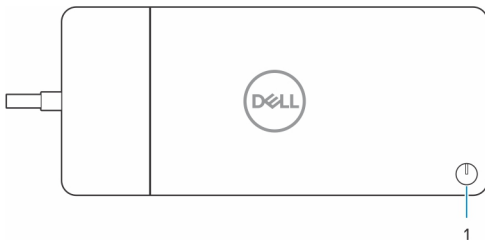

1. Sleep/Wake up/Power button

**i NOTE:** The dock button is designed to replicate your system's power button. If you connect the Dell Thunderbolt Dock WD22TB4 to supported Dell computers, the dock button works like your computer's power button and you can use it to power on/sleep/force shutdown the computer.

**i NOTE:** The dock button is only operational when connected to supported Dell computers.

## Front

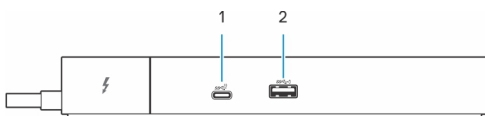

1. USB 3.2 Gen 2 Type-C port
2. USB 3.2 Gen 1 port with PowerShare

## Right

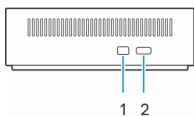

1. Wedge-shaped lock slot
2. Kensington security-cable slot

## Back

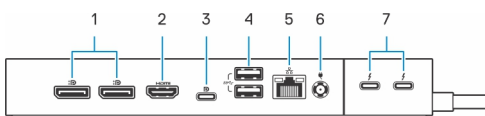

1. DisplayPort 1.4 ports
2. HDMI 2.0 port
3. USB 3.2 Gen 2 Type-C port with DisplayPort 1.4 Alt Mode
4. USB 3.2 Gen 1 ports



5. Network connector (RJ-45)
6. Power connector
7. Thunderbolt 4 ports

## Bottom

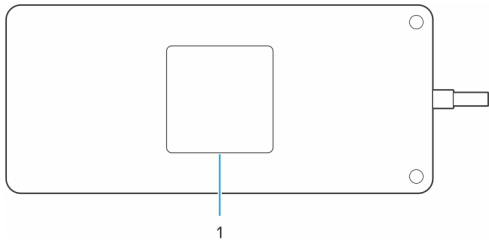

1. Service tag label

## Important Information

### Updating drivers on your system

It is recommended to update the following drivers on your system before using the docking station:

1. System BIOS
2. Graphics driver
3. Thunderbolt driver and Thunderbolt firmware
4. Ethernet driver

 **CAUTION: Older BIOS versions and drivers could result in the docking station not being recognized by your system or not functioning optimally.**

For Dell systems, you can visit [www.dell.com/support](http://www.dell.com/support) and enter the Service Tag or Express Service Code to find all relevant drivers. For more information on how to find the Service Tag for your computer, see [Locate the Service Tag on your computer](#).

For non-Dell systems, please visit the respective manufacturers support page to find the latest drivers.

### Updating the Dell Thunderbolt Dock - WD22TB4 driver set

To ensure that the Dock functions correctly, it is recommended installing the latest firmware available for the WD22TB4.

All available drivers can be found on [www.dell.com/support](http://www.dell.com/support).

### Drivers and Downloads FAQ

When troubleshooting, downloading or installing drivers it is recommended that you read the Dell Knowledge Based article, Drivers and Downloads FAQ [000123347](#).

# Setting up your docking station

## Steps

1. Update your system's BIOS, graphics, thunderbolt and network drivers from [www.dell.com/support/drivers](http://www.dell.com/support/drivers).

**NOTE:** Thunderbolt driver updates are only for systems that are natively configured with Thunderbolt hardware and is not applicable for Non-thunderbolt systems.

**CAUTION:** Ensure that the system is connected to a power source while installing the BIOS and drivers.

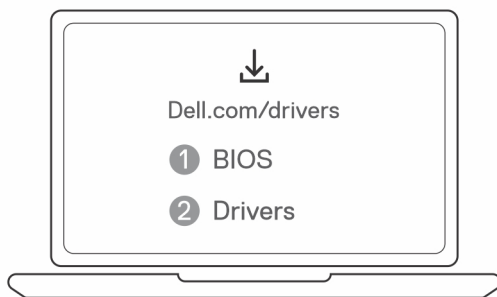

2. Connect the AC adapter to a power outlet. Then, connect the AC adapter to the 7.4 mm DC-in power input on the Dell Thunderbolt Dock - WD22TB4.

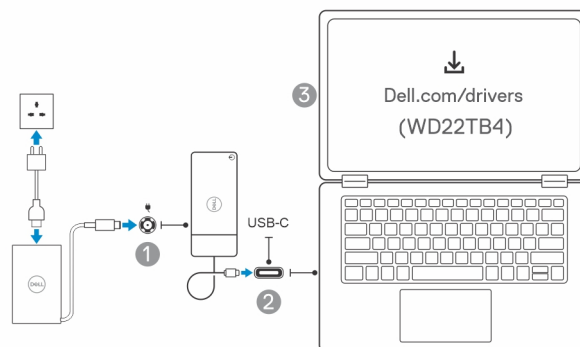

3. Connect the USB Type-C connector to the system.  
Update the Dell Thunderbolt Dock firmware from [www.dell.com/support/drivers](http://www.dell.com/support/drivers).
4. Connect multiple displays to the docking station, as needed.

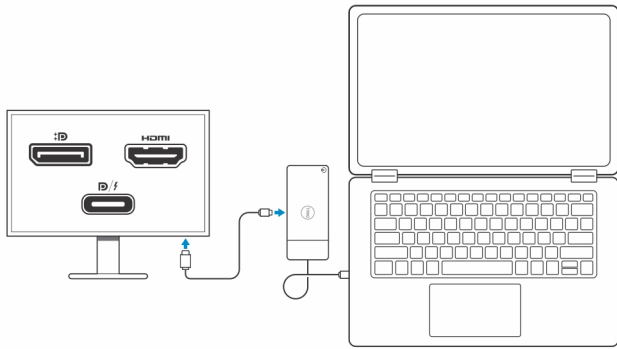

1		2		1			2		3			1				2		3			4			
DP + DP		DP + DP		DP + DP + HDMI			DP + DP + HDMI		DP + DP + DP + DP			DP + DP + DP + DP				DP + DP		DP + DP + DP			DP + DP + DP + DP			
DP + HDMI		DP + DP		DP + DP + DP			DP + DP + DP		DP + DP + DP + DP			DP + DP + DP + DP				DP + DP		DP + DP + DP			DP + DP + DP + DP			
DP + DP		DP + DP		DP + DP + DP			DP + DP + DP		DP + DP + DP + DP			DP + DP + DP + DP				DP + DP		DP + DP + DP			DP + DP + DP + DP			
DP + DP		DP + DP		DP + DP + DP			DP + DP + DP		DP + DP + DP + DP			DP + DP + DP + DP				DP + DP		DP + DP + DP			DP + DP + DP + DP			
HDMI + DP		DP + DP		DP + DP + DP			DP + DP + DP		DP + DP + DP + DP			DP + DP + DP + DP				DP + DP		DP + DP + DP			DP + DP + DP + DP			
DP + DP		DP + DP		DP + DP + DP			DP + DP + DP		DP + DP + DP + DP			DP + DP + DP + DP				DP + DP		DP + DP + DP			DP + DP + DP + DP			
DP + DP		DP + DP		DP + DP + DP			DP + DP + DP		DP + DP + DP + DP			DP + DP + DP + DP				DP + DP		DP + DP + DP			DP + DP + DP + DP			

The above table shows the different video port combinations available to connect multiple displays to the Dell WD22TB4 dock. For more details on supported display resolutions, please see [Display Resolution](#).

# Setup of External Monitors

## Configuring your Monitors

If connecting two displays, follow these steps:

### Steps

1. Click the **Start** button, and then select **Settings**.
2. Click **System** and select **Display**.

3. Under the **Multiplay displays** section, modify the display configuration as needed.

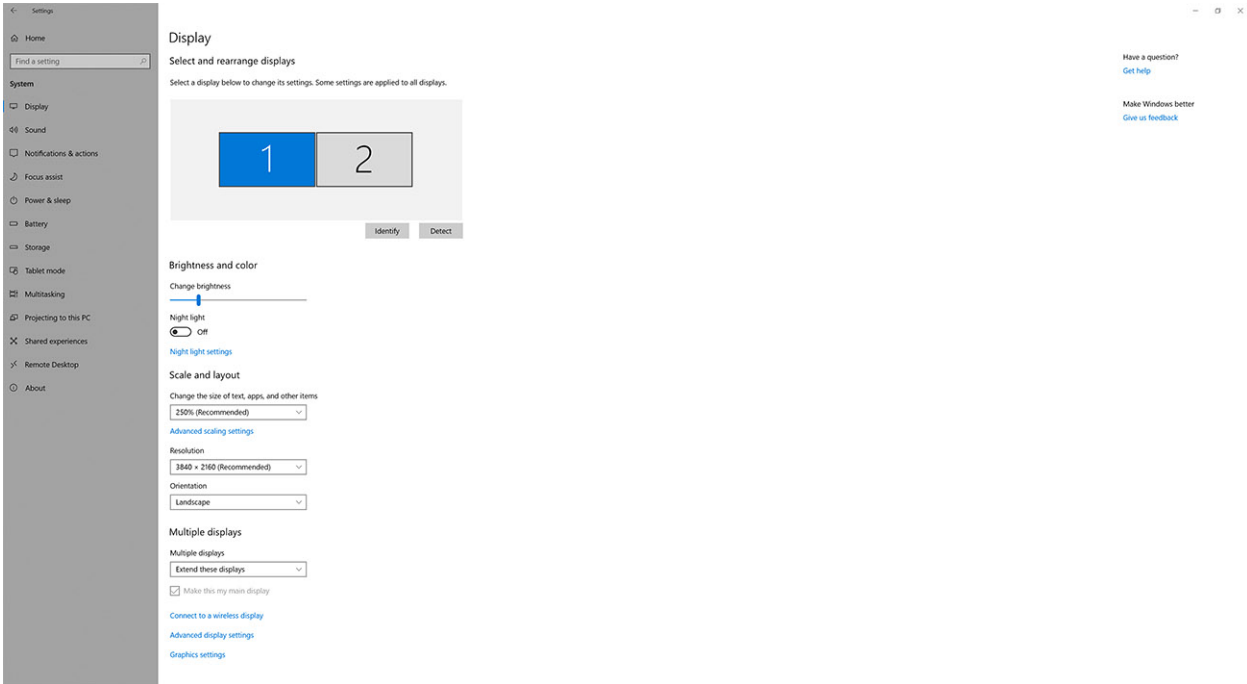

**NOTE:** The display topology can be configured, by moving around the displays in the "Select and rearrange displays" section, to change where the operating system assumes these monitors are located.

## Video connectors for multiple display setup

This topic provides details of the various video output configurations supported by your docking station.

### Important information

The Dell WD22TB4 dock supports multiple video output configurations with 2, 3 and 4 external displays.

**NOTE:** The HDMI and MFDP USB Type-C ports on the back of the WD22TB4 are muxed. Only one of these two ports can be used at a time. If the HDMI port is in use, the USB Type-C port will still retain USB functionality.

**NOTE:** The WD22TB4 supports non-Thunderbolt devices, but the connected devices will not support Thunderbolt features. Non-Thunderbolt devices connected to the two Thunderbolt ports at the back of the WD22TB4 supports USB 3.0 speeds.

**NOTE:** When connected to a Thunderbolt compatible device, the two ports support 40 Gbps speeds.

## Dual-display setup

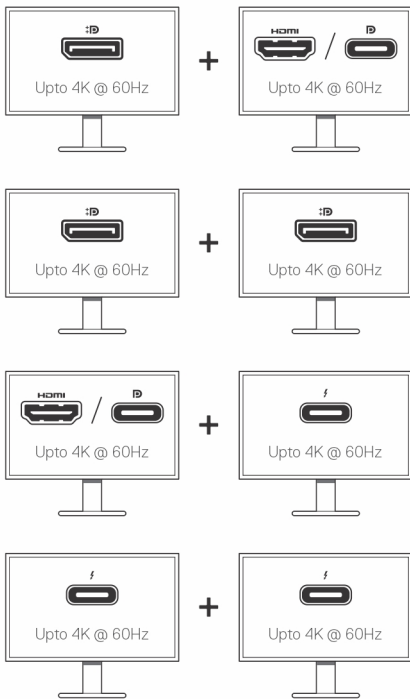

**Table 1. Dual-display connection**

Number of displays	Connector one	Connector two
Two (4K @60Hz)	DisplayPort 1.4	HDMI 2.0/MFDP Type-C
	DisplayPort 1.4	DisplayPort 1.4
	HDMI/MFDP Type-C	Thunderbolt Type-C port
	Thunderbolt Type-C ports	Thunderbolt Type-C port

## Triple-display setup

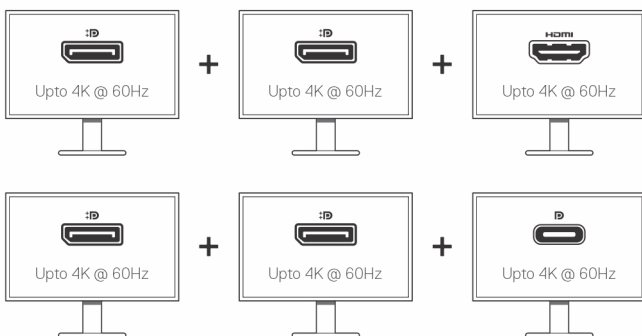

**Table 2. Triple-display connection**

Number of displays	Connector one	Connector two	Connector three
Three (4K @60Hz)	DisplayPort 1.4	DisplayPort 1.4	HDMI 2.0
	DisplayPort 1.4	DisplayPort 1.4	MFDP Type-C

## Quad-display setup

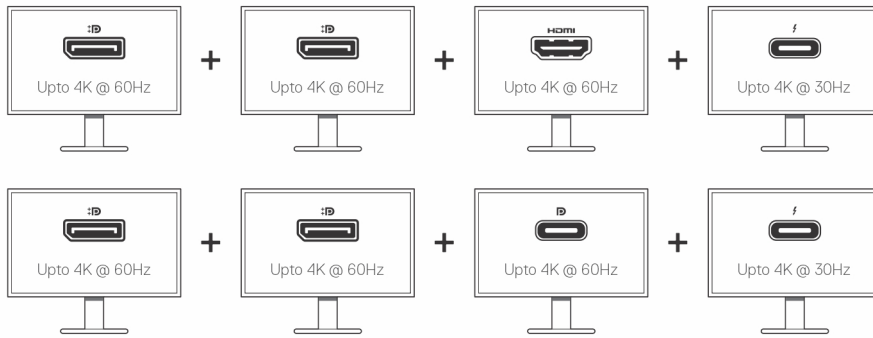

**Table 3. Quad-display connection**

Number of displays	Connector one	Connector two	Connector three	Connector four
Four (4K @60Hz)	DisplayPort 1.4	DisplayPort 1.4	HDMI 2.0	Thunderbolt Type-C
	DisplayPort 1.4	DisplayPort 1.4	MFDP Type-C	Thunderbolt Type-C

## Display bandwidth

External monitors require a certain amount of bandwidth to work properly. Monitors with higher resolution require more bandwidth.

- DisplayPort High Bit Rate 2 (HBR2) is 5.4 Gbps maximum link rate per lane. With DP overhead, the effective data rate is 4.3 Gbps per lane.
- DisplayPort High Bit Rate 3 (HBR3) is 8.1 Gbps maximum link rate per lane. With DP overhead, the effective data rate is 6.5 Gbps per lane.

**Table 4. Display bandwidth**

Resolution	Minimum bandwidth required
1 x FHD (1920 x 1080) display @60 Hz	3.2 Gbps
1 x QHD (2560 x 1440) display @60 Hz	5.6 Gbps
1 x 4K (3840 x 2160) display @30 Hz	6.2 Gbps
1 x 4K (3840 x 2160) display @60 Hz	12.5 Gbps

## Display Resolution Table

### WD22TB4 for Non-Thunderbolt systems

**Table 5. WD22TB4 for Non-Thunderbolt systems**

Display Port Available Bandwidth	Single Display (maximum resolution)	Dual Display (maximum resolution)	Triple Display (maximum resolution)	Quad Display (maximum resolution)
HBR2 (HBR2 x2 lanes - 8.6 Gbps)	DP 1.4/HDMI 2.0/MFDP Type-C/TBT	<ul style="list-style-type: none"> <li>• DP 1.4 + DP 1.4: FHD (1920 x 1080) @60 Hz</li> </ul>	<ul style="list-style-type: none"> <li>• DP 1.4 + DP 1.4 + HDMI 2.0:</li> </ul>	NA



**Table 5. WD22TB4 for Non-Thunderbolt systems (continued)**

Display Port Available Bandwidth	Single Display (maximum resolution)	Dual Display (maximum resolution)	Triple Display (maximum resolution)	Quad Display (maximum resolution)
	Type-C: 4K (3840 x 2160) @30 Hz	<ul style="list-style-type: none"> <li>• DP 1.4 + HDMI 2.0: FHD (1920 x 1080) @60 Hz</li> <li>• DP 1.4 + MFDP Type-C: FHD (1920 x 1080) @60 Hz</li> </ul>	<ul style="list-style-type: none"> <li>○ 1 x FHD (1920 x 1080) @60 Hz</li> <li>○ 2 x HD (1280 x 720) @60 Hz</li> <li>• DP 1.4 + DP 1.4 + MFDP Type-C: <ul style="list-style-type: none"> <li>○ 1 x FHD (1920 x 1080) @60 Hz</li> <li>○ 2 x HD (1280 x 720) @60 Hz</li> </ul> </li> </ul>	
HBR3 (HBR3 x2 lanes - 12.9 Gbps)	DP 1.4/HDMI 2.0/ MFDP Type-C/TBT Type-C: 4K (3840 x 2160) @30 Hz	<ul style="list-style-type: none"> <li>• DP 1.4 + DP 1.4: QHD (2560 x 1440) @60 Hz</li> <li>• DP 1.4 + HDMI 2.0: QHD (2560 x 1440) @60 Hz</li> <li>• DP 1.4 + MFDP Type-C: QHD (2560 x 1440) @60 Hz</li> </ul>	<ul style="list-style-type: none"> <li>• DP 1.4 + DP 1.4 + HDMI 2.0: FHD (1920 x 1080) @60 Hz</li> <li>• DP 1.4 + DP 1.4 + MFDP Type-C: FHD (1920 x 1080) @60 Hz</li> </ul>	<ul style="list-style-type: none"> <li>• DP 1.4 + DP 1.4 + HDMI 2.0: <ul style="list-style-type: none"> <li>○ 4 x SXGA (1280 x 1024) @60 Hz**</li> </ul> </li> <li>• DP 1.4 + DP 1.4 + MFDP Type-C: <ul style="list-style-type: none"> <li>○ 4 x SXGA (1280 x 1024) @60 Hz **</li> </ul> </li> </ul>
HBR3 with DSC (Display Stream Compression)	DP 1.4/HDMI 2.0/ MFDP Type-C: 4K (3840 x 2160) @60 Hz <b>OR</b> TBT Type-C 4K (3840 x 2160) @30 Hz	<ul style="list-style-type: none"> <li>• DP 1.4 + DP 1.4: QHD (2560 x 1440) @60 Hz</li> <li>• DP 1.4 + HDMI 2.0: QHD (2560 x 1440) @60 Hz</li> <li>• DP 1.4 + MFDP Type-C: QHD (2560 x 1440) @60 Hz</li> </ul>	<ul style="list-style-type: none"> <li>• DP 1.4 + DP 1.4 + HDMI 2.0: QHD (2560 x 1440) @60 Hz</li> <li>• DP 1.4 + DP 1.4 + MFDP Type-C: QHD (2560 x 1440) @60 Hz</li> </ul>	<ul style="list-style-type: none"> <li>• DP 1.4 + DP 1.4 + HDMI 2.0: <ul style="list-style-type: none"> <li>○ 3 x QHD (2560 x 1440) @60 Hz + 1 x HD (1280 x 720) @ 60 Hz **</li> </ul> </li> <li>• DP 1.4 + DP 1.4 + MFDP Type-C: <ul style="list-style-type: none"> <li>○ 3 x QHD (2560 x 1440) @60 Hz + 1 x HD (1280 x 720) @ 60 Hz **</li> </ul> </li> </ul>

\*\*Fourth display must be daisy chained through one of the monitors connected to DP 1.4 ports.

## WD22TB4 for Thunderbolt systems

**Table 6. WD22TB4 for Thunderbolt systems**

Display Port Available Bandwidth	Single Display (maximum resolution)	Dual Display (maximum resolution)	Triple Display (maximum resolution)	Quad Display (maximum resolution)
HBR2 (HBR2 x8 lanes - 34.5 Gbps)	DP1.4 /HDMI 2.0/ MFDP Type-C/USB Type-C TB: 4K (3840 x 2160) @60 Hz	<ul style="list-style-type: none"> <li>• DP 1.4 + DP 1.4: QHD (2560 x 1440) @60 Hz</li> <li>• DP 1.4 + HDMI 2.0: QHD (2560 x 1440) @60 Hz</li> <li>• DP 1.4 + MFDP Type-C: QHD (2560 x 1440) @60 Hz</li> </ul>	<ul style="list-style-type: none"> <li>• DP 1.4 + DP 1.4 + HDMI 2.0: 2 x QHD (2560 x 1440) @60 Hz + 1 x FHD (1920 x 1080)</li> <li>• DP 1.4 + DP 1.4 + MFDP Type-C: 2 x QHD (2560 x 1440) @60 Hz 1 x FHD (1920 x 1080)</li> <li>• DP 1.4 + DP 1.4 + TBT Type-C : 3 x QHD (2560 x 1440) @60 Hz</li> </ul>	NA

**Table 6. WD22TB4 for Thunderbolt systems (continued)**

Display Port Available Bandwidth	Single Display (maximum resolution)	Dual Display (maximum resolution)	Triple Display (maximum resolution)	Quad Display (maximum resolution)
		<ul style="list-style-type: none"> <li>• DP 1.4 + TBT Type-C: 4K (3840 x 2160) @60 Hz</li> <li>• HDMI 2.0 + TBT Type-C: 4K (3840 x 2160) @60 Hz</li> <li>• MFDP Type-C + TBT Type-C: 4K (3840 x 2160) @60 Hz</li> </ul>	<ul style="list-style-type: none"> <li>• DP 1.4 + MFDP Type-C + TBT Type-C: 3 x QHD (2560 x 1440) @60 Hz</li> <li>• DP 1.4 + HDMI 2.0 + TBT Type-C: 3 x QHD (2560 x 1440) @60 Hz</li> </ul>	
HBR3 (HBR3 x4 lanes + HBR3 x1 - 32.4 Gbps)	DP 1.4/HDMI 2.0/MFDP Type-C/TBT Type-C: 4K (3840x4320) @60Hz	<ul style="list-style-type: none"> <li>• DP 1.4 + DP 1.4: 4K (3840 x 2160) @60 Hz</li> <li>• DP 1.4 + HDMI 2.0: 4K (3840 x 2160) @60 Hz</li> <li>• DP 1.4 + MFDP Type-C: 4K (3840 x 2160) @60 Hz</li> <li>• DP 1.4 + TBT Type-C: <ul style="list-style-type: none"> <li>○ 1 x 4K (3840 x 2160) @60 Hz</li> <li>○ 1 x QHD (2560 x 1440) @60 Hz</li> </ul> </li> <li>• HDMI 2.0 + TBT Type-C: <ul style="list-style-type: none"> <li>○ 1 x 4K (3840 x 2160) @60 Hz</li> <li>○ 1 x QHD (2560 x 1440) @60 Hz</li> </ul> </li> <li>• MFDP Type-C + TBT Type-C: <ul style="list-style-type: none"> <li>○ 1 x 4K (3840 x 2160) @60 Hz</li> <li>○ 1 x QHD (2560 x 1440) @60 Hz</li> </ul> </li> </ul>	<ul style="list-style-type: none"> <li>• DP 1.4 + DP 1.4 + HDMI 2.0: <ul style="list-style-type: none"> <li>○ 1 x 4K (3840 x 2160) @60 Hz</li> <li>○ 2 x QHD (2560 x 1440) @60 Hz</li> </ul> </li> <li>• DP 1.4 + DP 1.4 + MFDP Type-C: <ul style="list-style-type: none"> <li>○ 1 x 4K (3840 x 2160) @60 Hz</li> <li>○ 2 x QHD (2560 x 1440) @60 Hz</li> </ul> </li> <li>• DP 1.4 + DP 1.4 + TBT Type-C: <ul style="list-style-type: none"> <li>○ 2 x 4K (3840 x 2160) @60 Hz</li> <li>○ 1 x QHD (2560 x 1440) @60 Hz</li> </ul> </li> <li>• DP 1.4 + MFDP Type-C + TBT Type-C: <ul style="list-style-type: none"> <li>○ 2 x 4K (3840 x 2160) @60 Hz</li> <li>○ 1 x QHD (2560 x 1440) @60 Hz</li> </ul> </li> <li>• DP 1.4 + HDMI 2.0 + TBT Type-C: <ul style="list-style-type: none"> <li>○ 2 x 4K (3840 x 2160) @60 Hz</li> <li>○ 1 x QHD (2560 x 1440) @60 Hz</li> </ul> </li> </ul>	<ul style="list-style-type: none"> <li>• DP 1.4 + DP 1.4 + HDMI 2.0 + TBT Type-C: QHD (2560 x 1440) @60 Hz</li> <li>• DP 1.4 + DP 1.4 + MFDP Type-C + TBT Type-C: QHD (2560 x 1440) @60 Hz</li> </ul>
HBR3 with DSC (Display Stream Compression)	DP 1.4/HDMI 2.0/MFDP Type-C/TBT Type-C: 4K (3840x4320) @60Hz	<ul style="list-style-type: none"> <li>• DP 1.4 + DP 1.4: 4K (3840 x 2160) @60 Hz</li> <li>• DP 1.4 + HDMI 2.0: 4K (3840 x 2160) @60 Hz</li> <li>• DP 1.4 + MFDP Type-C: 4K (3840 x 2160) @60 Hz</li> <li>• DP 1.4 + TBT Type-C: <ul style="list-style-type: none"> <li>○ 1 x 4K (3840 x 2160) @60 Hz</li> </ul> </li> </ul>	<ul style="list-style-type: none"> <li>• DP 1.4 + DP 1.4 + HDMI 2.0: <ul style="list-style-type: none"> <li>○ 3 x 4K (3840 x 2160) @60 Hz</li> </ul> </li> <li>• DP 1.4 + DP 1.4 + MFDP Type-C: <ul style="list-style-type: none"> <li>○ 3 x 4K (3840 x 2160) @60 Hz</li> </ul> </li> <li>• DP 1.4 + DP 1.4 + TBT Type-C: <ul style="list-style-type: none"> <li>○ 2 x 4K (3840 x 2160) @60 Hz</li> <li>○ 1 x QHD (2560 x 1440) @60 Hz</li> </ul> </li> </ul>	<ul style="list-style-type: none"> <li>• DP 1.4 + DP 1.4 + HDMI 2.0 + TBT Type-C: 3 x 4K (3840 x 2160) @60 Hz + 1 x QHD (2560 x 1440) @60 Hz</li> </ul> <p><b>OR</b></p> <ul style="list-style-type: none"> <li>3 x 4K (3840 x 2160) @60 Hz + 1 x 4K (3840 x 2160) @30 Hz</li> </ul> <ul style="list-style-type: none"> <li>• DP 1.4 + DP 1.4 + MFDP Type-C + TBT Type-C:</li> </ul>

**Table 6. WD22TB4 for Thunderbolt systems (continued)**

Display Port Available Bandwidth	Single Display (maximum resolution)	Dual Display (maximum resolution)	Triple Display (maximum resolution)	Quad Display (maximum resolution)
		<ul style="list-style-type: none"> <li>○ 1 x QHD (2560 x 1440) @60 Hz</li> <li>● HDMI 2.0 + TBT Type-C:                             <ul style="list-style-type: none"> <li>○ 1 x 4K (3840 x 2160) @60 Hz</li> <li>○ 1 x QHD (2560 x 1440) @60 Hz</li> </ul> </li> <li>● MFDP Type-C + TBT Type-C:                             <ul style="list-style-type: none"> <li>○ 1 x 4K (3840 x 2160) @60 Hz</li> <li>○ 1 x QHD (2560 x 1440) @60 Hz</li> </ul> </li> </ul>	<ul style="list-style-type: none"> <li>● DP 1.4 + MFDP Type-C + TBT Type-C:                             <ul style="list-style-type: none"> <li>○ 2 x 4K (3840 x 2160) @60 Hz</li> <li>○ 1 x QHD (2560 x 1440) @60 Hz</li> </ul> </li> <li>● DP 1.4 + HDMI 2.0 + TBT Type-C:                             <ul style="list-style-type: none"> <li>○ 2 x 4K (3840 x 2160) @60 Hz</li> <li>○ 1 x QHD (2560 x 1440) @60 Hz</li> </ul> </li> </ul>	3 x 4K (3840 x 2160) @60 Hz + 1 x QHD (2560 x 1440) @60 Hz  <b>OR</b>  3 x 4K (3840 x 2160) @60 Hz + 1 x 4K (3840 x 2160) @30 Hz

## Port disablement

**Table 7. Port disablement**

Ports connected to display	Ports disabled
<ul style="list-style-type: none"> <li>● Two DisplayPort 1.4 ports (rear)</li> <li>● One HDMI 2.0 port (rear)</li> <li>● One Thunderbolt 4 port (rear)</li> </ul>	Second Thunderbolt 4 Type-C port supports data only (rear)
Two Thunderbolt 4 Type-C port (rear)	<ul style="list-style-type: none"> <li>● Two DisplayPort 1.4 ports (rear)</li> <li>● One HDMI 2.0 port (rear)</li> <li>● One USB 3.2 Gen 2 Type-C port with DisplayPort 1.4 Alt Mode</li> </ul>

## Important

- NOTE:** HDMI 2.0 and MFDP (Multi-Function DisplayPort) Type-C ports on the back of are toggled. HDMI 2.0 and MFDP Type-C cannot support dual monitors simultaneously. Only one of these ports can be used at a time.
- NOTE:** If higher resolution monitors are used, the Graphics driver makes a judgment based on monitor specifications and display configurations. Some resolutions may not be supported and so will be removed from the Windows Display Control Panel.
- NOTE:** Linux operating system is unable to physically turn-off built-in display, the external display numbers will be one less than the display numbers listed in above tables.
- NOTE:** Resolution support is also dependent on the monitor's Extended Display Identification Data (EDID) resolution.

# Replacing the USB Type-C cable module

## Prerequisites

The Dell Thunderbolt Dock - WD22TB4 ships with a serviceable cable module. The USB Type-C cable module on the docking station can be removed and replaced by following these steps:

## Steps

1. Turn over the docking station.

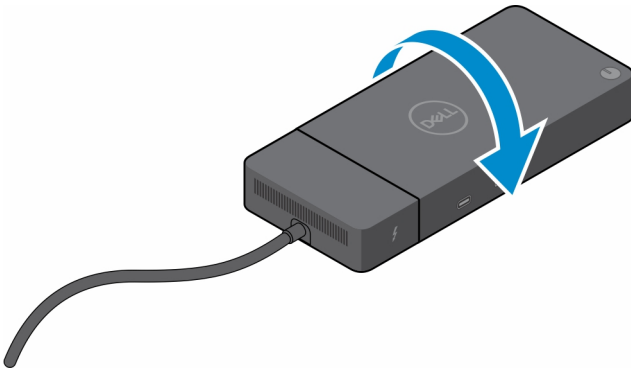

2. Remove the two (M2.5 x 5) screws from the bottom plate of the docking station.

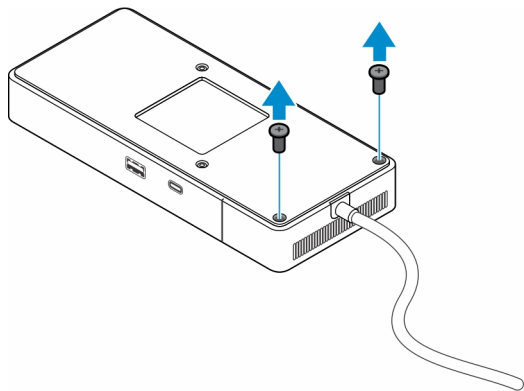

3. Using a plastic scribe, gently pull the cable module away from the docking station.

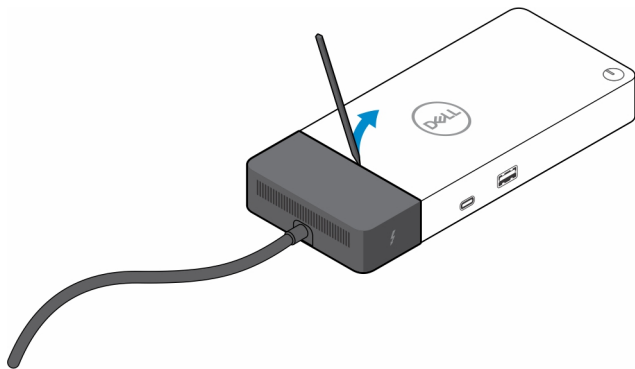

4. Gently wiggle and remove the USB Type-C cable module from its connector on the docking station.

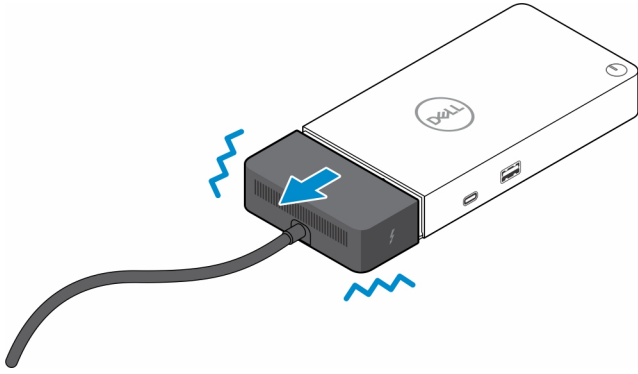

5. Take the replacement cable module out of its packaging.

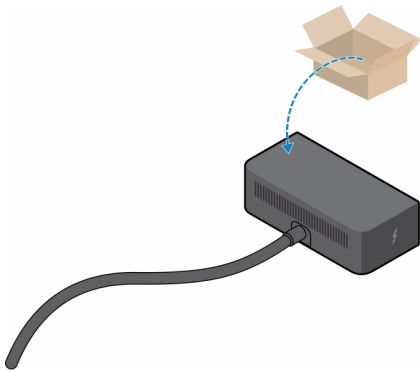

6. Align and place the cable module on to the docking station.

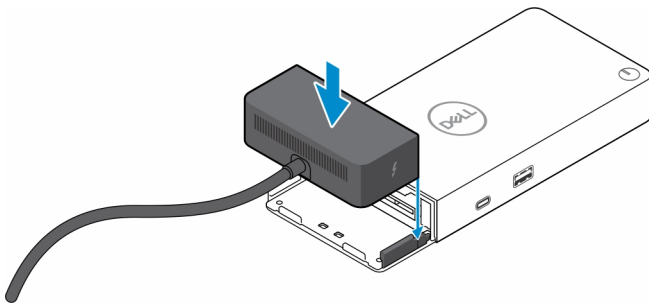

7. Slide and push the cable module to connect the cable module to the connectors on the docking station.

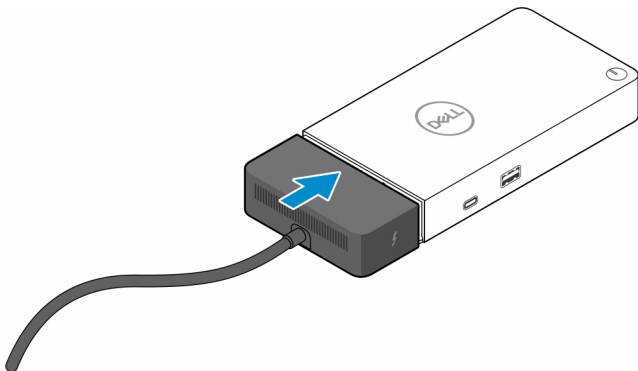

8. Replace the two (M2.5 x 5) screws to the bottom plate of the docking station.

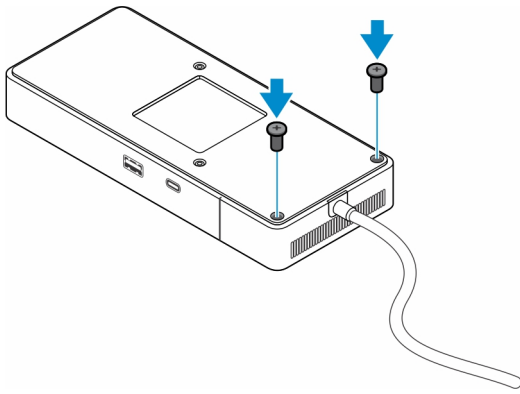

9. Turn the docking station over.

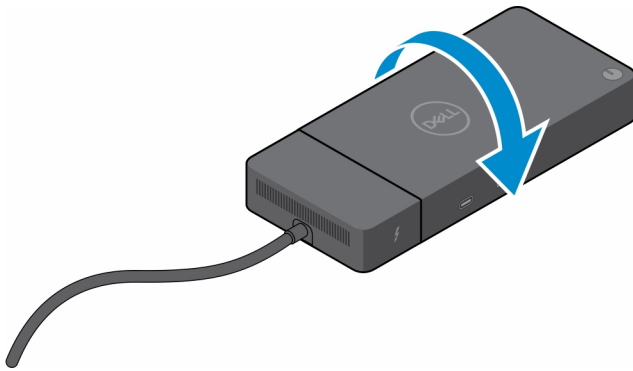

## Upgrading your WD19 docks

The following topics describes the process to upgrade the WD19 series docking stations.

### Upgrade the cable module to Thunderbolt 4

The following docking stations are compatible with Thunderbolt 4 cable module as on the Dell Thunderbolt Dock - WD22TB4:

1. Dell Dock - WD19
2. Dell Dock - WD19S
3. Dell Thunderbolt Dock - WD19TB
4. Dell Thunderbolt Dock - WD19TBS
5. Dell Performance Dock - WD19DC
6. Dell Performance Dock - WD19DCS

**NOTE:** Before the cable module is replaced on these models, the dock firmware must be updated to the latest version available for WD22TB4 at [www.dell.com/support](http://www.dell.com/support). If this is not done, the docking stations will not function or may run with Thunderbolt 4 capabilities disabled.

**NOTE:** Once the cable module is replaced, the firmware on the docking stations must be updated again to the latest available for the Dell Thunderbolt Dock - WD22TB4.

**NOTE:** A few WD19 docking stations variants ship with a 130 W AC adapter. After upgrading to the Thunderbolt 4 cable module, the docking station will require a 180 W AC adapter to function as the Dell Thunderbolt Dock - WD22TB4.

**Table 8. Firmware update requirements when upgrading to the WD22TB4 cable module**

Original dock	New module	Firmware update before upgrading cable module	Firmware update after upgrading cable module
1. Dell Dock - WD19 2. Dell Dock - WD19S	WD22TB4 cable module	Required	Required



**Table 8. Firmware update requirements when upgrading to the WD22TB4 cable module (continued)**

<b>Original dock</b>	<b>New module</b>	<b>Firmware update before upgrading cable module</b>	<b>Firmware update after upgrading cable module</b>
<b>3.</b> Dell Thunderbolt Dock - WD19TB <b>4.</b> Dell Thunderbolt Dock - WD19TBS <b>5.</b> Dell Performance Dock - WD19DC <b>6.</b> Dell Performance Dock - WD19DCS			
Dell Thunderbolt Dock - WD22TB4	WD22TB4 cable module	Not required	Not required
Dell Thunderbolt Dock - WD22TB4	WD19 cable module	Not required	Not required

# Technical specifications

## Product specifications

Table 9. Product specifications

Feature	Specifications
Model	WD22TB4
Video ports	<ul style="list-style-type: none"> <li>1 x USB 3.2 Gen2 Type-C with DisplayPort 1.4 Alt Mode</li> <li>2 x DisplayPort 1.4</li> <li>1 x HDMI 2.0</li> <li>2 x Type-C with Thunderbolt 4 port (connected to a Thunderbolt 4 host)</li> </ul>
External displays supported	Up to 4
USB Type-A ports	<ul style="list-style-type: none"> <li>2 x USB 3.2 Gen1</li> <li>1 x USB 3.2 Gen1 with PowerShare</li> </ul>
USB Type-C ports	<ul style="list-style-type: none"> <li>1 x USB 3.2 Gen2 Type-C</li> <li>2 x Type-C with Thunderbolt 4 port (connected to a Thunderbolt 4 host)</li> <li> <b>NOTE:</b> On non-thunderbolt systems, the ports function as USB Type-C ports.</li> <li>1 x USB 3.2 Gen2 Type-C with DisplayPort 1.4 Alt Mode</li> </ul>
Network	<p>Gigabit Ethernet (RJ-45)</p> <p>Support Wake On LAN from S0, S3, S4, or S5 sleep state with select Dell systems. See platform setup guide for more details.</p> <p>Support MAC Address Pass-Through with select Dell systems. See platform setup guide for more details.</p>
LED indicators	<ul style="list-style-type: none"> <li>Power button LED</li> <li>Power adapter LED</li> <li>Docking cable connector LED</li> <li>RJ-45 LEDs</li> </ul>
AC adapter options	180 W
Dimensions	<p>205 mm x 90 mm x 29 mm</p> <p>8.07 in. x 3.54 in. x 1.14 in.</p>
Weight	650 g (1.43 lb)
DC-in Port	7.4 mm
Cable	0.8 m for WD22TB4
Power delivery	<ul style="list-style-type: none"> <li>130 W to Dell systems with 180 W AC-adapter</li> <li>90 W to Non-Dell system with 180 W AC-adapter</li> </ul>

**Table 9. Product specifications (continued)**

Feature	Specifications
System requirements	Compatible with USB Type-C Thunderbolt systems and USB Type-C systems with DisplayPort Alt Mode
Power button function	Sleep/Wakeup/Power button <b>i</b> <b>NOTE:</b> On compatible Dell systems, the power button mimics the host power button behavior.
Operating systems	<ul style="list-style-type: none"> <li>Windows 10</li> <li>Windows 11</li> <li>Ubuntu 20.04 and later version</li> </ul>
Systems management	<ul style="list-style-type: none"> <li>Wireless vPro supported by the notebook, tablet, or workstation</li> <li>Kernel Direct Memory Access (DMA) protection</li> </ul>
MAC address	Pass-through MAC address <b>i</b> <b>NOTE:</b> On Dell systems, check the BIOS to confirm MAC address pass-through support.

## Power adapter specifications

**Table 10. Power adapter specifications**

Dell AC Adapter Specifications	180 W
Input voltage	100 to 240 VAC
Input current (max)	2.34 A
Input frequency	50 to 60 Hz
Output current	9.23 A (continuous)
Rated output voltage	19.5 VDC
Weight (lb)	1.32
Weight (kg)	0.60
Dimensions (in.)	1.18 x 3.0 x 6.1
Dimensions (mm)	30 x 76.2 x 155
Temperature range operating	0°C to 40°C 32°F to 104°F
Storage	-40°C to 70°C -40°F to 158°F

## Port disablement

Port Disablement is a system feature that enables user to selectively disable DisplayPort or Thunderbolt protocols over USB Type-C ports.

- The feature is offered through BIOS and requires user to boot to BIOS Setup Menu to activate/deactivate the feature.
- Port Disablement is handled at low level and cannot be deactivated by operating system.
- The Port Disablement is extended to Dell Docks by importing system configuration and applying the settings locally.

## New Gen MFDP (Multi-Function Display Port) Systems

New generation of systems with MFDP Type-C ports offers following configuration options in BIOS:

1. Enable/Disable External USB Port to enable/disable USB protocol over USB Type-A and Type-C ports.
2. Enable/Disable Integrated NIC (this setting will be imported by Dock).

The table below illustrates how those settings will affect functionality of the Dock:

**Table 11. New Gen MFDP (Multi-Function Display Port) Systems**

	MFDP system		Docked system configuration		Dell WD22TB4 Dock					
	BIOS setup options				Thunderbolt Module	Base				
Case	Enable external USB ports	Disable USB4 PCIe Tunneling	Dock Override	System Dock port power delivery modes	Thunderbolt port	LAN	Video ports	Type-C MFDP port	Type-C USB port	Type-A USB port
1	Off	NA	Off	Power only	Power only	Disabled	Disabled	Disabled	Disabled	Disabled
			On	USB4/DP/USB	DP	By system setup	DP/HDMI	DP	Disabled	Disabled
2	On	Off	Off	USB4/DP/USB	USB4/DP/USB	Enabled	DP/HDMI	DP/USB	USB3/USB2	USB3/USB2
			On	USB4/DP/USB	USB4/DP/USB	By system setup	DP/HDMI	DP/USB	USB3/USB2	USB3/USB2
		On	Off	USB4/DP/USB	USB4/DP/USB	Enabled	DP/HDMI	DP/USB	USB3/USB2	USB3/USB2
			On	USB4/DP/USB	USB4/DP/USB	By system setup	DP/HDMI	DP/USB	USB3/USB2	USB3/USB2

## New Gen TBT (Thunderbolt) Systems

New generation of systems with Thunderbolt ports offers following configuration options in BIOS:

1. Enable/Disable Thunderbolt to activate Thunderbolt Controller and enable Thunderbolt protocol over USB Type-C port.
2. Enable/Disable External USB Port to enable USB protocol over USB Type-A and Type-C ports.
3. Enable/Disable Integrated NIC (this setting will be imported by Dock).

The table below illustrates how those settings will affect functionality of the Dock:

**Table 12. New Gen TBT (Thunderbolt) Systems**

	MFDP system				Docked system configuration		Dell WD22TB4 Dock					
	BIOS setup options						Thunderbolt Module	Base				
Case	Enable external USB ports	Video & power only	Enable Thunderbolt	Disable USB4 PCIe Tunneling	Dock Override	System Dock port power delivery	Thunderbolt port	LAN	Video ports	Type-C MFDP port	Type-C USB port	Type-A USB port

**Table 12. New Gen TBT (Thunderbolt) Systems (continued)**

	MFDP system				Docked system configuration	Dell WD22TB4 Dock							
	BIOS setup options					Thunderbolt Module	Base						
						Power modes							
1	Off	NA	NA	NA	Off	Power only	Power only	Disabled	Disabled	Disabled	Disabled	Disabled	Disabled
					On	USB4/DP/USB	DP	By system setup	DP/HDMI	DP	Disabled	Disabled	
2	On	On	NA	NA	Off	DP	DP	Disabled	DP/HDMI	DP	Disabled	Disabled	
					On	USB4/TBT/DP/USB	DP	By system setup	DP/HDMI	DP	Disabled	Disabled	
3	On	Off	On	Off	Off	USB4/TBT/DP/USB	USB4/TBT/DP/USB	Enabled	DP/HDMI	DP/USB	USB3/USB2	USB3/USB2	
					On	USB4/TBT/DP/USB	USB4/TBT/DP/USB	By system setup	DP/HDMI	DP/USB	USB3/USB2	USB3/USB2	
4a	On	Off	Off	Off	Off	USB4/TBT/DP/USB	USB4/TBT/DP/USB	Enabled	DP/HDMI	DP/USB	USB3/USB2	USB3/USB2	
					On	USB4/TBT/DP/USB	USB4/TBT/DP/USB	By system setup	DP/HDMI	DP/USB	USB3/USB2	USB3/USB2	
4b	On	Off	On	On	Off	USB4/TBT/DP/USB	USB4/TBT/DP/USB	Enabled	DP/HDMI	DP/USB	USB3/USB2	USB3/USB2	
					On	USB4/TBT/DP/USB	USB4/TBT/DP/USB	By system setup	DP/HDMI	DP/USB	USB3/USB2	USB3/USB2	

**NOTE:** PCIe tunneling is disabled so downstream PCIe devices won't be functional, no native Thunderbolt3 devices will be active.

**NOTE:** With Disable PCIe Tunneling Enabled, Dock Override shouldn't be allowed.

## Legacy Thunderbolt systems

Legacy systems offer one extra option that was rarely used but made configuration very complex:

1. Enable/Disable Thunderbolt to activate Thunderbolt Controller and enable Thunderbolt protocol over USB Type-C port.
2. Enable/Disable External USB Port to enable USB protocol over USB Type-A and Type-C ports.

3. Enable Dell Docks - dynamic override to extend system settings to boundary of the dock (dock port connected to Dell Dock was fully functional and Dock took care about handling dock port disablement locally).
4. Enable/Disable Integrated NIC (this setting will be imported by Dock).

The table below illustrates how those settings would affect functionality of the WD22TB4 Dock (for reference only, please consult Dell Customer service for more details):

**Table 13. Legacy Thunderbolt systems**

	TBT system			Docked system configuration	Dell WD22TB4 Dock						
	BIOS setup options				Thunderbolt Module, Downstream port			Base			
Case	External USB	Thunderbolt	Override to allow Dell dock	System Dock port power delivery modes	Type-C Thunderbolt port	DP	USB	LAN	Video ports	Type-C MFDP port	Type A and Type-C USB ports
1	On	On	N/A	TBT/DP/USB	Working	Working	Working	By system setup	Enabled	DP/USB	Enabled
2	On	Off	On	TBT/DP/USB	No function	Working	Working	By system setup	Enabled	DP/USB	Enabled
<b>3</b>	<b>Off</b>	<b>On</b>	<b>On</b>	<b>TBT/DP/USB</b>	<b>Working</b>	<b>Working</b>	<b>No function</b>	<b>By system setup</b>	<b>Enabled</b>	<b>DP mode</b>	<b>Disabled</b>
4	Off	Off	On	TBT/DP/USB	No function	Working	No function	By system setup	Enabled	DP mode	Disabled
5	On	Off	Off	TBT/DP/USB	No function	Working	Working	By system setup	Enabled	DP/USB	Enabled
<b>6</b>	<b>Off</b>	<b>On</b>	<b>Off</b>	<b>TBT/DP/USB</b>	<b>Working</b>	<b>Working</b>	<b>No function</b>	<b>By system setup</b>	<b>Enabled</b>	<b>DP mode</b>	<b>Disabled</b>
7	Off	Off	Off	TBT/DP/USB	No function	Working	No function	Disabled	Enabled	DP mode	Disabled

## LED Status Indicators

### Power Adapter LED

**Table 14. Power Adapter LED indicator**

State	LED Behavior
Power Adapter is plugged into wall socket	Flash three times

### Docking Status Indicator

**Table 15. Docking Station LED Indicators**

State	LED Behavior
Docking station is receiving power from power adapter	Flash three times

**Table 16. Cable LED Indicators**

State	LED Behavior
USB Type-C host supports video + data + power	On
USB Type-C host does not support video + data + power	Off (will not illuminate)

**Table 17. RJ-45 LED Indicators**

Link Speed Indicators	Ethernet Activity Indicator
10 Mb = Green	Amber Flashing
100 Mb = Amber	
1 Gb = Green + Orange	

## Dell ExpressCharge and ExpressCharge Boost overview

- Dell ExpressCharge enables an empty battery to charge to 80% in about one hour when the system is turned off and to 100% in approximately two hours.
- Dell ExpressCharge Boost enables an empty battery to charge to 35% in 15 minutes.
- Metrics are created for **system off** given charge time with the system on has varied results.
- Customers must enable ExpressCharge mode in the BIOS or through Dell Power Manager to take advantage of these features.
- Check your Dell Latitude, XPS or Precision system for the battery size using the table to determine compatibility.

**Table 18. Dell ExpressCharge compatibility**

Power Delivery to System	Max Battery Size for ExpressCharge	Max Battery Size for ExpressCharge Boost
90 W with 130 W adapter	92 Whr	53 Whr
130 W with 180 W adapter	100 Whr	76 Whr

## Docking specifications

**Table 19. Operating and storage environment**

Description	Operating	Storage
Temperature range	0°C–35°C (32°F–95°F)	<ul style="list-style-type: none"> <li>• Storage: -20°C to 60°C (-4°F to 140°F)</li> <li>• Shipping: -20°C to 60°C (-4°F to 140°F)</li> </ul>
Relative humidity (maximum)	10% to 80% (non-condensing)	<ul style="list-style-type: none"> <li>• Storage: 5% to 90% (non-condensing)</li> <li>• Shipping: 5% to 90% (non-condensing)</li> </ul>
<p> <b>CAUTION:</b> Operating and storage temperature ranges may differ among components, so operating or storing the device outside these ranges may impact the performance of specific components.</p>		

# Dell docking station firmware update

## Standalone Dock Firmware Update utility

**NOTE:** Information that is provided is for Windows users running the executable tool. For other operating systems or further detailed instructions see the WD22TB4 admin guide available on [www.dell.com/support](http://www.dell.com/support).

Download the Dell WD22TB4 dock driver and firmware update from [www.dell.com/support](http://www.dell.com/support). Connect the dock to the system and start the tool in administrative mode.

1. Wait for all the information to be entered in the various Graphical User Interface (GUI) panes.

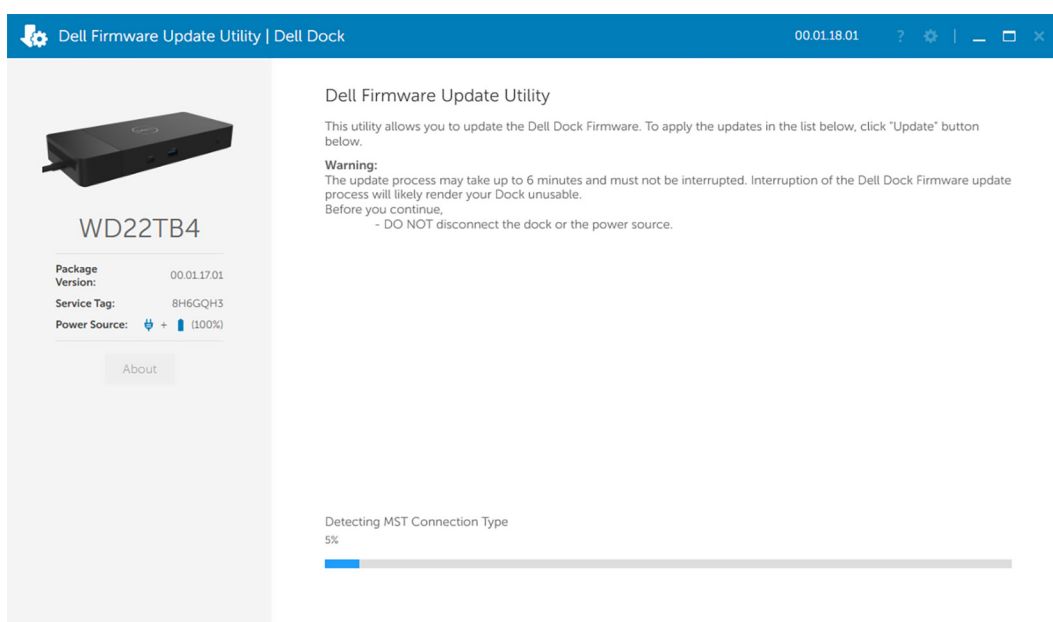

2. **Update** and **Exit** buttons are displayed in the bottom-right corner. Click the **Update** button.

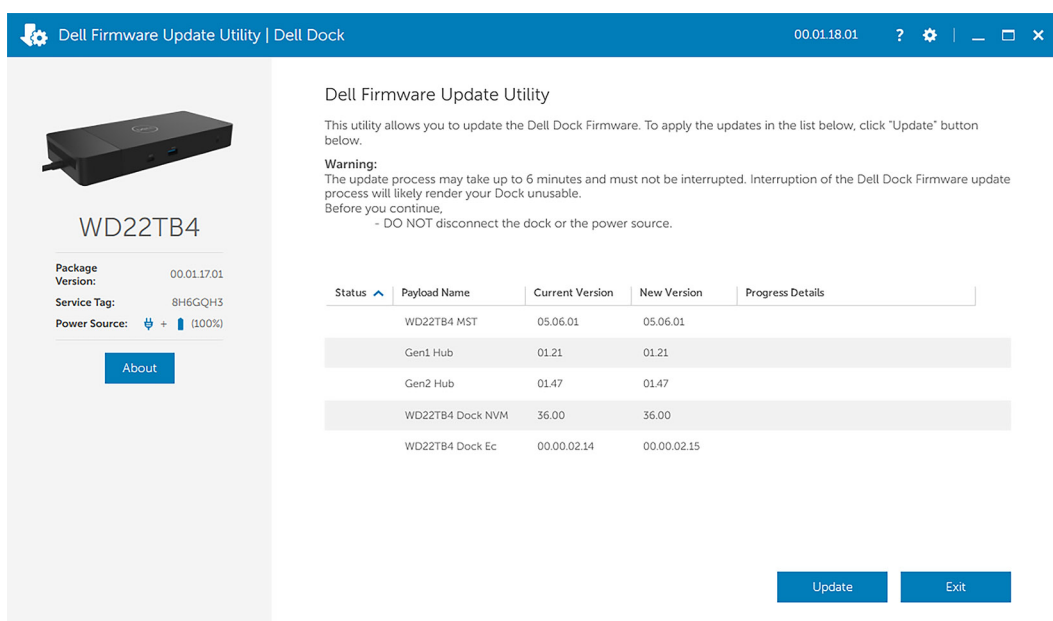



3. Wait for all the component firmware update to complete. A progress bar is displayed in the bottom.

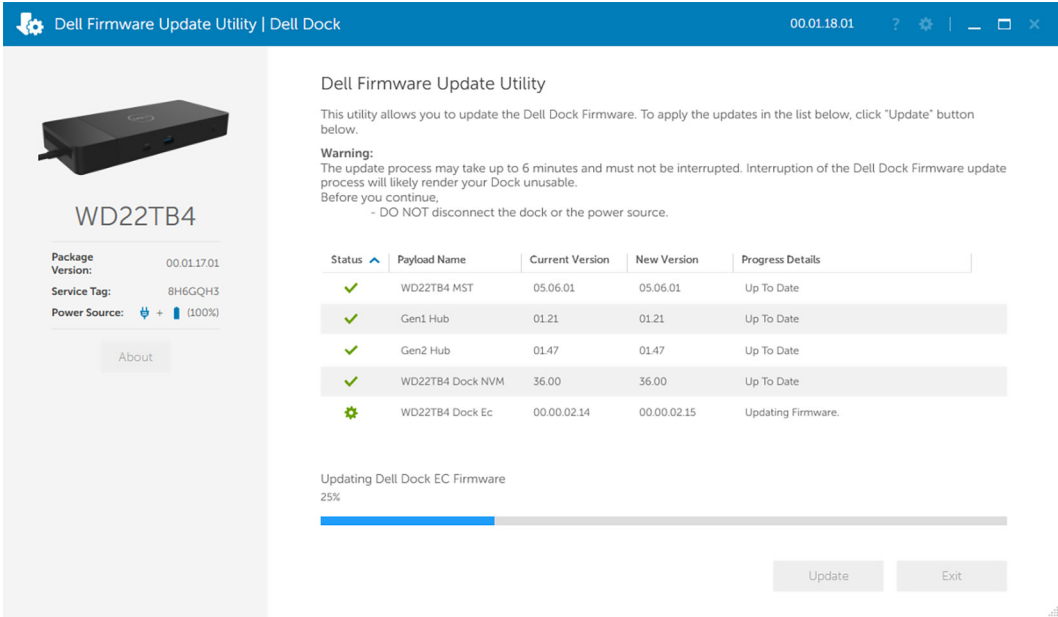

4. The update status is displayed above the payload information.

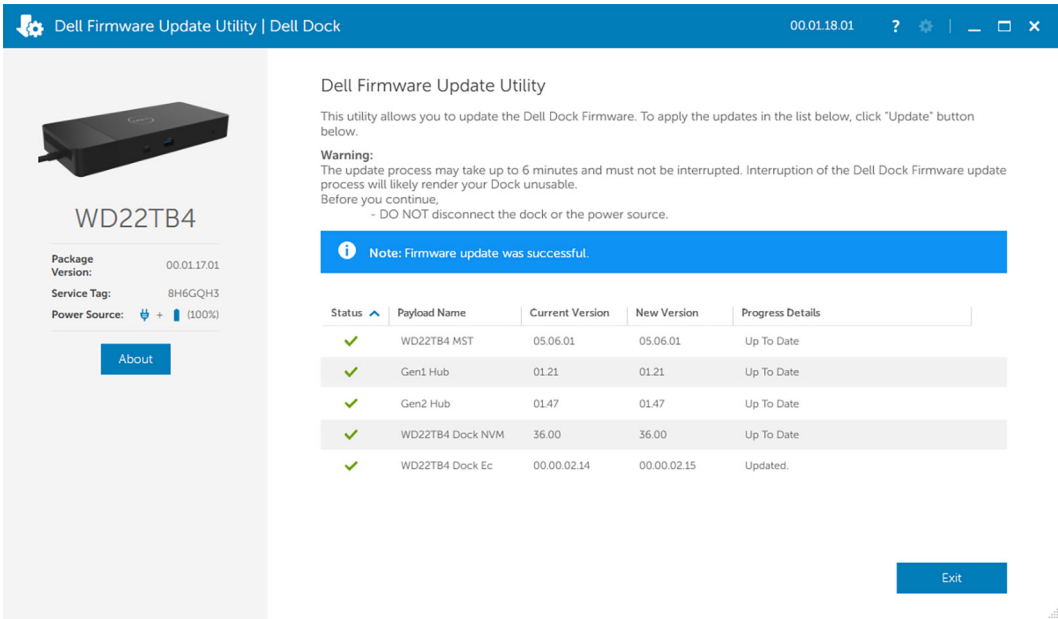

**Table 20. Command-Line Options**

Command lines	Function
/? or /h	Usage.
/s	Silent.
/l=<filename>	Log file.
/verflashexe	Display utility version.
/componentsvers	Display current version of all dock firmware components.

For IT professionals and engineers, to get more information about the following technical topics, see the Dell Docking Station Admin's Guide:

- Step-by-step standalone DFU (Dock Firmware Update) and driver update utilities.
- Using DCU (Dell Command | Update) for driver download.

- Dock asset management locally and remotely through DCM (Dell Command | Monitor) and SCCM (System Center Configuration Manager).

# Frequently asked questions

## 1. Fans not working, abnormal, or loud fan noise, overheating:

Fans that continue to spin quickly and make abnormally loud noises might indicate a problem. Common causes for fans not working, abnormal, or loud fan noise, overheating:

- Fans or air vents that are obstructed
- Dust accumulation on vents or fans
- Not enough ventilation
- Physical damage
- Out-of-date BIOS and device drivers

## 2. Fan noise heard when the AC adapter is plugged into the dock:

- When plugging in the AC adapter and powering on the docking station, the fan turns on for sometime and subsequently powers down. This is by design and the docking stations is working as expected.

## 3. What is the charging station feature?

- The Dell Thunderbolt Dock WD22TB4 can charge your phone or other USB powered devices even without being connected to the system. However, the AC adapter must be connected to the docking stations for this to work.

## 4. Why am I asked to approve Thunderbolt Devices after the Windows logon and what should I do?

- This is for Thunderbolt security. You are asked to approve a Thunderbolt device because the Thunderbolt Security level on your unit is set to "User Authorization" or "Secure Connect" in BIOS Setup. You will not see this page if the Thunderbolt Security level on your system is set to "No Security" or "DisplayPort Only". Also, if you checked "Enable Thunderbolt Boot Support" in the BIOS Setup and power-on the system with the WD22TB4 dock attached, you will not see this page because the Security level is overridden to "No Security" in this case. When you are asked to approve a Thunderbolt device, you may select "Always Connect" if you do not have any security concerns to always allow the Thunderbolt device connection to your system. Or you may select "Connect Only Once" or "Do Not Connect" if you do have concerns.

## 5. Why does the hardware installation window show up when I plug in a USB device to the docking stations ports?

- When a new device is plugged in, the USB hub driver notifies the Plug and Play (PnP) manager that a new device was detected. The PnP manager queries the hub driver for all of the device's hardware IDs and then notifies the Windows OS that a new device needs to be installed. In this scenario, the user will see a hardware installation window.

## 6. Why do the peripheral devices connected to the dock station become unresponsive after recovering from a power loss?

- The docking station is designed to operate on AC power only and it does not support system power source back (powered by system Type-C port). A power loss event will disconnect all devices connected to the dock . Even when you restore the AC power, the dock may still not function properly because the dock still needs to negotiate proper power contract with the system's Type-C port and establish a system EC-to-dock-EC connection.
- Disconnect and reconnect the AC adapter from the back of the docking station to fix this issue.

## 7. Entering the BIOS setup using F2 or F12 does not work at POST from an external keyboard attached to the dock. It boots to the operating system and the keyboard and mouse only work after the operating system boots.

- To enable pre-boot setup options using F2 and F12 from the dock, you must enable boot support for thunderbolt devices and must set fast boot to **Enabled** or **Auto Enabled** in the BIOS.

# Troubleshooting the Dell Thunderbolt Dock - WD22TB4

## Symptoms and solutions

Table 21. Symptoms and solutions

Symptoms	Suggested solutions
<p>1. No video on the monitors attached to the High Definition Multimedia Interface (HDMI), or DisplayPort (DP) port on the docking station.</p>	<ul style="list-style-type: none"> <li>• Ensure that the latest BIOS and drivers for your computer and the docking station are installed on your computer.</li> <li>• Make sure your computer is connected to the docking station securely. Try to disconnect and reconnect the docking station to the notebook computer.</li> <li>• Disconnect both ends of the video cable and check for damaged/bent pins. Securely re-connect the cable to the monitor and docking station.</li> <li>• Make sure the video cable (HDMI, or DisplayPort) is connected properly to the monitor and the docking station. Ensure to select the correct video source on your monitor (refer to your monitor's documentation for more information about changing the video source).</li> <li>• Check the resolution settings on your computer. Your monitor may support higher resolutions than what the docking station is able to support. Please see the <a href="#">Display Resolution Table</a> for more information on maximum resolution capacity.</li> <li>• If your monitor is connected to the docking station, the video output on your computer may be disabled. You can enable the video output using the Intel Graphics Control Panel or refer to the User Guide of your computer.</li> <li>• If only one monitor is shown, while the other is not, go to Windows Display Properties, and under <b>Multiple Displays</b>, select the output for the second monitor.</li> <li>• Using Intel graphics and using the system LCD, only two displays can be supported.</li> <li>• For Nvidia or AMD discrete graphics, the dock supports three external displays plus the system LCD.</li> <li>• Try with a different monitor and cable that is known to be good, if possible.</li> </ul>
<p>2. The video on the attached monitor is distorted or flickering.</p>	<ul style="list-style-type: none"> <li>• Reset the monitor to Factory Defaults. Refer to the User Guide of your monitor for more information on how to reset the monitor to factory defaults.</li> <li>• Ensure that the video cable (HDMI, or DisplayPort) is connected securely to the monitor and the docking station.</li> <li>• Disconnect and reconnect the monitor/s from the docking station.</li> <li>• First power off the docking station by disconnecting the Type-C cable and then removing the power adapter from the dock. Then, power on the docking station by connecting power adapter to the dock before connecting the Type-C cable to your computer.</li> </ul>

**Table 21. Symptoms and solutions (continued)**

Symptoms	Suggested solutions
	<ul style="list-style-type: none"> <li>• Undock and reboot the system if, the above steps do not work.</li> </ul>
<p>3. The video on the attached monitor is not displaying as an Extended Monitor.</p>	<ul style="list-style-type: none"> <li>• Ensure that the Intel HD Graphics driver is installed in the Windows Device Manager.</li> <li>• Ensure that the nVidia or AMD Graphics driver is installed in the Windows Device Manager.</li> <li>• Open the Windows Display Properties and go to <b>Multiple Displays</b> control to set the display to the extended mode.</li> </ul>
<p>4. The USB ports are not functioning on the docking station.</p>	<ul style="list-style-type: none"> <li>• Ensure that the latest BIOS and drivers for your computer and the docking station are installed on your computer.</li> <li>• If your BIOS Setup has a USB Enabled/Disabled option, make sure it is set to <b>Enabled</b>.</li> <li>• Verify if the device is detected in Windows Device Manager and that the correct device drivers are installed.</li> <li>• Ensure that the docking station is connected securely to the notebook computer. Try to disconnect and reconnect the docking station to the computer.</li> <li>• Check the USB ports. Try plugging the USB device into another port.</li> <li>• First power off the docking station by disconnecting the Type-C cable and then removing the power adapter from the dock. Then, power on the docking station by connecting the power adapter to the dock before connecting the Type-C cable to your computer.</li> </ul>
<p>5. The High-Bandwidth Digital Content Protection (HDCP) content is not displayed on the attached monitor.</p>	<ul style="list-style-type: none"> <li>• Dell Dock supports HDCP upto HDCP 2.2.</li> </ul> <p> <b>NOTE:</b> User's monitor/display must support HDCP 2.2</p>
<p>6. The LAN port is not functioning.</p>	<ul style="list-style-type: none"> <li>• Ensure that the latest BIOS and drivers for your computer and the docking station are installed on your computer.</li> <li>• Ensure that the RealTek Gigabit Ethernet Controller is installed in the Windows Device Manager.</li> <li>• If your BIOS Setup has a LAN/GBE Enabled/Disabled option, make sure it is set to <b>Enabled</b></li> <li>• Ensure that the Ethernet cable is connected securely on the docking station and the hub/router/firewall.</li> <li>• Check the status LED of the Ethernet cable to confirm connectivity. Re-connect both ends of the Ethernet cable if the LED is not lit.</li> <li>• First power off the docking station by disconnecting the Type-C cable and then removing the power adapter from the dock. Then, power on the docking station by connecting the power adapter to the dock before connecting the Type-C cable to your computer.</li> </ul>
<p>7. Cable LED is not ON after it is connected to your host.</p>	<ul style="list-style-type: none"> <li>• Make sure the WD22TB4 is connected to AC power.</li> <li>• Make sure the laptop is connected with the docking station. Try to disconnect and re-connect again with the docking station.</li> <li>• Make sure that the host port supports MFDP.</li> </ul>
<p>8. USB port has no function in a pre-OS environment.</p>	<ul style="list-style-type: none"> <li>• Check the <b>BIOS &gt; Integrated Devices</b> for USB/Thunderbolt Configuration options, and make sure the following options are checked:             <ul style="list-style-type: none"> <li>• 1. Enable USB Boot Support</li> <li>• 2. Enable External USB Port</li> <li>• 3. Enable Thunderbolt Boot Support</li> </ul> </li> </ul>

**Table 21. Symptoms and solutions (continued)**

Symptoms	Suggested solutions
9. PXE boot on dock does not function.	<ul style="list-style-type: none"> <li>● Check the <b>BIOS &gt; System Management</b> for integrated NIC options, and select <b>Enabled w/PXE</b>.</li> <li>● If your BIOS Setup on your computer has an USB/Thunderbolt Configuration page, please make sure the following options are checked:               <ul style="list-style-type: none"> <li>● 1. Enable USB Boot Support</li> <li>● 2. Enable Thunderbolt Boot Support</li> </ul> </li> </ul>
10. USB Boot does not function.	<ul style="list-style-type: none"> <li>● If your BIOS has an USB/Thunderbolt Configuration page, please make sure the following options are checked:               <ul style="list-style-type: none"> <li>● 1. Enable USB Boot Support</li> <li>● 2. Enable External USB Port</li> <li>● 3. Enable Thunderbolt Boot Support</li> </ul> </li> </ul>
11. AC Adapter is displayed as “Not Installed” in the Battery Information page of the Dell BIOS Setup when the Type-C/Thunderbolt 3 Type-C cable is connected.	<ul style="list-style-type: none"> <li>● 1. Make sure the WD22TB4 is connected properly to its own adapter (130 W).</li> <li>● 2. Make sure the cable LED of your docking station is ON.</li> <li>● 3. Disconnect and then re-connect the Type-C/Thunderbolt 4 (Type-C) cable to your computer.</li> </ul>
12. Peripherals connected to the docking station do not work in a pre-OS environment.	<ul style="list-style-type: none"> <li>● Thunderbolt Boot Support is by default disabled in BIOS Setup on your Dell computer. With such default setting the docking station and the peripherals connected to the docking station do not work in a pre-OS environment.</li> <li>● If the BIOS Setup on your computer has an USB/Thunderbolt Configuration page, check the following options to enable docking station function in a pre-OS environment:               <ul style="list-style-type: none"> <li>● Enable External USB Port</li> <li>● Enable Thunderbolt Boot Support</li> </ul> </li> </ul>
13. Alert message “You have attached an undersized power adapter to your system or Undersized adapter” is displayed when the docking station is connected to your computer.	<ul style="list-style-type: none"> <li>● Make sure the docking station is connected properly to its own power adapter. Computers that require more than 130 W power input must also be connected to their own power adapter for charging and optimal performance.</li> </ul>
14. Undersized power adapter warning message displayed and cable LED is off.	<ul style="list-style-type: none"> <li>● The docking connector has disconnected from the system's USB/Thunderbolt ports. Please reconnect the docking cable from the system, wait for 15 seconds or more, and then dock again.</li> </ul>
15. No external display. USB or data and cable LED is off.	<ul style="list-style-type: none"> <li>● The docking connector has disconnected from the system's USB/Thunderbolt ports. Please reconnect the docking connector.</li> <li>● Undock and reboot the system if the above steps do not work.</li> </ul>
16. When system or dock is moved the cable LED turns off.	<ul style="list-style-type: none"> <li>● Avoid moving the system/dock when the docking cable is connected to the system.</li> </ul>
17. With Ubuntu 18.04 LTS, WIFI will be turned off when the docking station is connected to the system and the WIFI turns On again after rebooting the system.	<ul style="list-style-type: none"> <li>● Please uncheck the option <b>Control WLAN radio</b> in BIOS.</li> <li>● Option is available in - Settings -&gt; Power Management -&gt; Wireless Radio Control</li> </ul>
18. When WD22TB4 dock has no power.	<ul style="list-style-type: none"> <li>● Disconnect USB Type-C from the system and the WD22TB4 power adapter.</li> <li>● Re-plug the WD22TB4 AC adapter.</li> <li>● WD22TB4 dock LED blinks 3 times.</li> </ul>
19. When WD22TB4 dock is not working even when BIOS, firmware and drivers are up to date.	<p>Check BIOS/Firmware/Driver is updated.</p> <p>If Yes:</p>

**Table 21. Symptoms and solutions (continued)**



<b>Symptoms</b>	<b>Suggested solutions</b>
	<ul style="list-style-type: none"><li>● Restart the dock.</li></ul> If Yes: <ul style="list-style-type: none"><li>● Re-plug the docking AC adapter</li><li>● Restart the dock.</li></ul> If Yes: <ul style="list-style-type: none"><li>● Re-plug the docking AC adapter</li><li>● Restart the dock. If the dock does not respond</li><li>● Enable WD22TB4 display support matrix</li><li>● Restart the dock</li></ul>

# Getting help and contacting Dell

## Self-help resources

You can get information and help on Dell products and services using these self-help resources:

**Table 22. Self-help resources**

Self-help resources	Resource location
Information about Dell products and services	<a href="http://www.dell.com">www.dell.com</a>
My Dell app	
Tips	
Contact Support	In Windows search, type <code>Contact Support</code> , and press Enter.
Online help for operating system	<a href="http://www.dell.com/support/windows">www.dell.com/support/windows</a>
Access top solutions, diagnostics, drivers and downloads, and learn more about your computer through videos, manuals and documents.	Your Dell computer is uniquely identified by a Service Tag or Express Service Code. To view relevant support resources for your Dell computer, enter the Service Tag or Express Service Code at <a href="http://www.dell.com/support">www.dell.com/support</a> .  For more information on how to find the Service Tag for your computer, see <a href="#">Locate the Service Tag on your computer</a> .
Dell knowledge base articles for a variety of computer concerns	<ol style="list-style-type: none"> <li>1. Go to <a href="http://www.dell.com/support">www.dell.com/support</a>.</li> <li>2. On the menu bar at the top of the Support page, select <b>Support &gt; Knowledge Base</b>.</li> <li>3. In the Search field on the Knowledge Base page, type the keyword, topic, or model number, and then click or tap the search icon to view the related articles.</li> </ol>

## Contacting Dell

To contact Dell for sales, technical support, or customer service issues, see [www.dell.com/contactdell](http://www.dell.com/contactdell).

 **NOTE:** Availability varies by country/region and product, and some services may not be available in your country/region.

 **NOTE:** If you do not have an active Internet connection, you can find contact information about your purchase invoice, packing slip, bill, or Dell product catalog.