

# HDBaseT Scaler with HDMI and Analog Audio Outputs

*AT-HDVS-150-RX*

User Manual

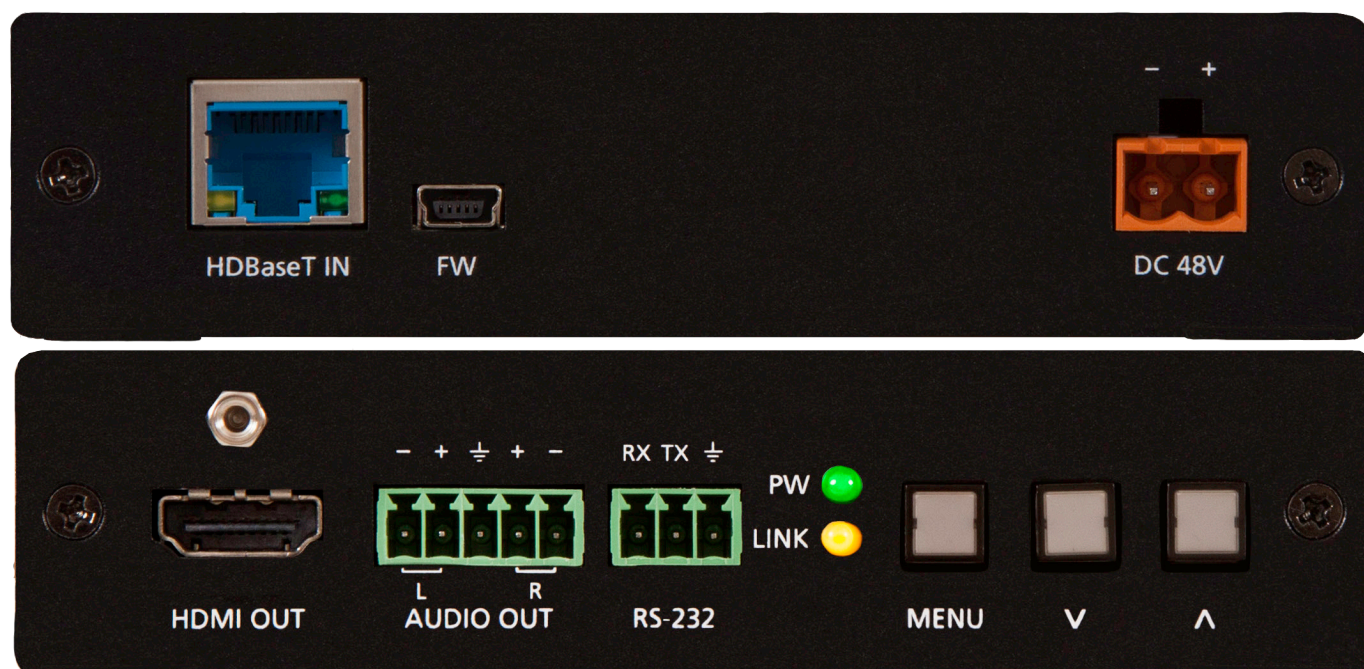

Please check <http://www.atlona.com/products/AT-HDVS-150-RX/> for the most recent **firmware update** or **manual**

## Table of Contents

1. Introduction	3
2. Package Contents	3
3. Features	3
4. Panel Descriptions	
a. Front Panel	4
b. Rear Panel	4
5. OSD Menu	5-6
6. RS-232 & Software	7-11
7. Connection Diagram	12
8. Specifications	13
9. Safety Information	14
10. Warranty	15-16
11. Atlona Product Registration	16

**Note:** To ensure compatibility, please be certain both transmitter and receiver have blue HDBaseT ports. This ensures both products are PoE (48V) compliant. The HDVS-200-TX is not compatible with PoCC (black RJ45, 24V) devices

## Introduction

Atlona HDVS receiver was designed to smooth the transition from analog to digital displays in schools and businesses, allowing advanced HDMI display devices to be used with the many VGA computers still in use. Many displays don't support the resolutions and refresh rates typical of VGA sources. In addition, the HDVS-150-RX is compatible with Atlona PoE switchers with HDBaseT outputs and is a good solution when scaling is required for a specific display.

When used with a matching HDVS-150-TX or HDVS-150-TX-WP, projector control is enabled. HDBaseT and Power over Ethernet (PoE) allow signal and power over a single category cable, with RS-232 control capability.

**Note:** To ensure compatibility, please be certain both transmitter and receiver have blue HDBaseT ports. This ensures both products are PoE (48V) compliant. The HDVS-200-TX is not compatible with PoCC (black RJ45, 24V) devices

## Package Contents

- 1 x AT-HDVS-150-RX
- 3 x Captive screw female connector (5 pin: audio, 3 pin: RS-232, 2 pin: power)
- 1 x 48V DC captive screw power adapter
- 1 x User manual

## Features

- Scales incoming signals at a variety of common resolutions up to 1080p or 1920x1200
- Complete control of video brightness, contrast, saturation, hue, and more
- Extends common resolutions up to 1080p or 1920x1200 to distances as long as 230ft (70 meters)
- Front panel on-screen menu control for ease of use
- Set preferred input resolution to match display requirements
- 2 channel balanced analog audio output to an amplifier (e.g. AT-PA100-G2)
- PoE (Power over Ethernet) sends power to compatible transmitters
  - **e.g.** AT-HDVS-150-TX-WP or AT-HDVS-150-TX
- Ability to switch HDCP reporting between compliant, noncompliant, and auto
- Firmware upgradable for easy field service through USB

## Panel Description

### Front Panel

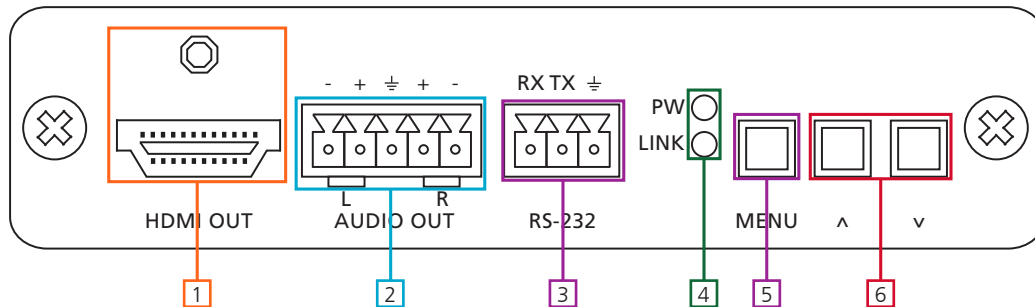

1. **HDMI OUT:** Connect to display
  2. **AUDIO OUT:** Connect to amplifier (e.g. AT-PA100-G2)
  3. **RS-232:** Connect to PC or control system to program RS-232 control then connect to a display for on / off command control
  4. **Status LEDs:**
    - POWER LED - Illuminates when receiving power
    - LINK LED - Lights up when HDBaseT link is functioning properly
  5. **MENU** button: Use to enter, exit, and select within the on-screen display menu
  6. **Navigation** buttons: Navigate through OSD menu or use to set output resolutions
    - "Menu" and "-": Set output resolution to 720p@50Hz
    - "-" and "+": Factory resets receiver and sets output resolution to 720p@60Hz
- Note:** Pressing the "+" button while the OSD menu is closed and a VGA source is selected will cause the video to auto adjust

### Back Panel

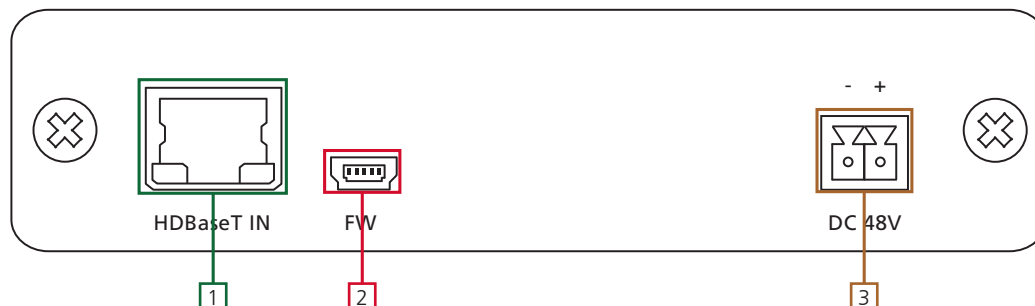

1. **HDBaseT IN** (blue): Connect HDBaseT source here
2. **FIRMWARE:** Connect to a PC using a mini USB to USB for firmware updating
3. **DC 48V:** Connect included 48V DC adapter to power HDVS-150-RX and compatible transmitters

**Note:** To ensure compatibility, please be certain both transmitter and receiver have blue HDBaseT ports. This ensures both products are PoE (48V) compliant. The HDVS-200-TX is not compatible with PoCC (black RJ45, 24V) devices

## OSD Menu

Menu Option	Sub-Menu Option	Adjust	
Input Select	VGA		
	HDMI		
	HDMI 2		(AT-HDVS-150-TX)
	Menu Back		
Input Resolution	800x600	1280x800	1920x1200
	1024x768	1366x768	
	1280x720	1920x1080	
Output Resolution	1024x768	720p59.94	1080p60
	1280x800	720p60	Native
	1280x1024	1080i50	Menu Back
	1366x768	1080i59.94	
	1400x1050	1080i60	
	1600x1200	1080p23.98	
	1680x1050	1080p24	
	1920x1200	1080p25	
	720p35	1080p29.97	
	720p29.97	1080p30	
	720p30	1080p50	
	720p50	1080p59.94	
	VGA Adjust		
Picture Adjust	Brightness	0 to 100	
	Contrast	0 to 100	
	Saturation	0 to 100	
	Hue	0 to 100	
	Sharpness	0 to 100	
	Picture Reset		
	Menu Back		
Aspect	Full	Full Screen	
	16:9 TV		
	16:10 TV		
	4:3 TV		
	Keep Ratio		
	Menu Back		
Overscan	Enable	Yes or No	
	H Size %	0 to 50%	
	V Size %	0 to 50%	
	Menu Back		
Audio	Audio On/Off	On or Off (mute)	
	HDMI Audio	On or Off	
	L/R Audio	On or Off	
	Menu Back		

Menu Option	Sub-Menu Option	Adjust
OSD	Position	Left-Top, Right-Top, Right-Bottom, Left-Bottom, Center
	Transparency	0 (transparent) to 15 (solid)
	Info. Timer	5 to 100 seconds
	Menu Timer	5 to 100 seconds
	Info. Display	Always On, Auto, or Always Off
	Background	Grey, Cyan, Magenta, or Yellow
	Menu Back	
Others	In Auto Switch	On or Off
	Display HDCP	Compliant, Noncompliant, Auto
	Mirror-V	On or Off
	ASP Background	Grey, Black
	Display Mode	DispSW AVon, DispSW AVSW, AV SW, Always On
	Disp. Key Lock	0 to 15 seconds
	Auto Disp. On	On or Off
	Auto Disp. Off	On or Off
	ProJSW Mode	5 to 300 (increases by 5)
	Standby (min.)	0 to 15
	Menu Back	
Information	Source Name Product	
	Sink Model Native 1 Native 2	
	F/W TX: RX: Menu Back	
System Reset	No	
	Yes	
	Menu Back	
Menu Exit		

**Note:** Display Mode does a variety of changes, see below

**DispSW AVon:** Display switches on/off, source audio/video signal always on

**DispSW AVSW:** Display switches on/off, source audio/video signal switches on/off

**AV SW:** Display is always on, source audio/video signal switches on/off

**Always On:** Default, no function

**Note:** Unit must be in DispSW AVon or DispSW AVSW for RS-232 display control to work

**ProJSW Mode:** Used with a projector whose lamp cannot be turned on for up to 5 minutes after being shut off. Keeps control in same state as projector. Match settings with lamp delay on projector in 5 to 300 seconds. The LED will blink for the full amount of the delay time (ex. 40 seconds)

**Standby (min.):** Adjusts period of time before scaler goes into standby following loss of signal. Default is 0 minutes (standby off)

**Note:** Standby must be active for Display Off to work - Standby time will set display off time as well.

## RS-232

### Connection

RS-232 pin out is determined by the connected device and connects as RX (receiver), TX (transmitter), and  $\perp$  (ground). (See picture 1)

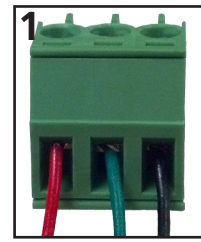
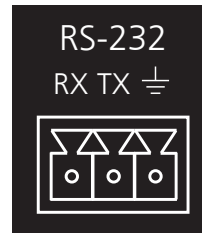

Wire color differs by cable manufacturer.

RS-232 is often connected through a DB 9-pin to captive screw connector. The pins have specific signals associated with them, some are unassigned.

**Note:** Typical DB9 connectors use pin 2 for TX, pin 3 for RX, and pin 5 for ground. On some devices, the functions of pins 2 and 3 are reversed.

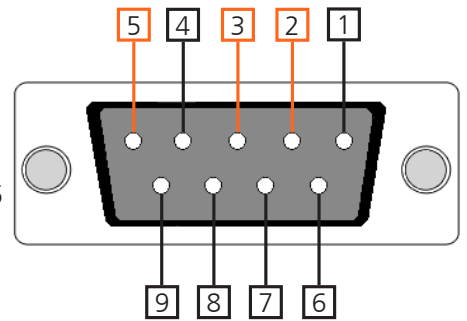

### Set up and Control Software

Set up and control software can be found on the AT-HDVS-150-RX webpage on atlona.com.

URL: <http://www.atlona.com/products/AT-HDVS-150-RX.html> (software found under the "Downloads" tab)

### Set Up

1. Connect the HDVS-150-RX to a PC using a DB9 to DB9 and DB9 to USB adaptor cable

**Note:** A gender changer and/or null modem may be needed between some connections

a. Remove the DB9 connector, strip and connect the wires to the included captive screw connector (as explained above), then connect the captive screw connector to the switcher

**Note:** Receiver must be disconnected from the display for RS-232 set up

2. Go to the device manager folder (see picture A) on your computer

3. Find the receiver COM port.

**Note:** If unsure which COM port is connected, unplug the USB cable and plug it back in. It will disappear and reappear on the COM port list.

4. Open the software, select the correct COM port, and press connect. (see picture B)

**Note:** You can test the connection by pressing READ

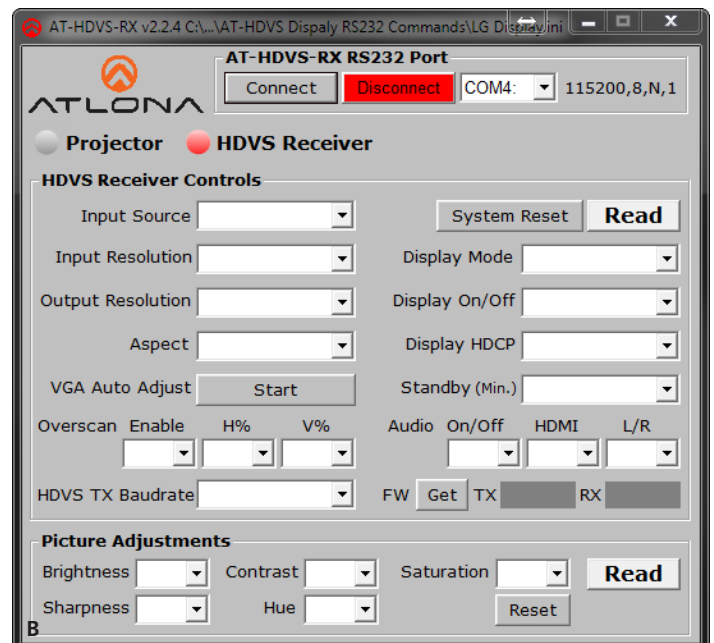
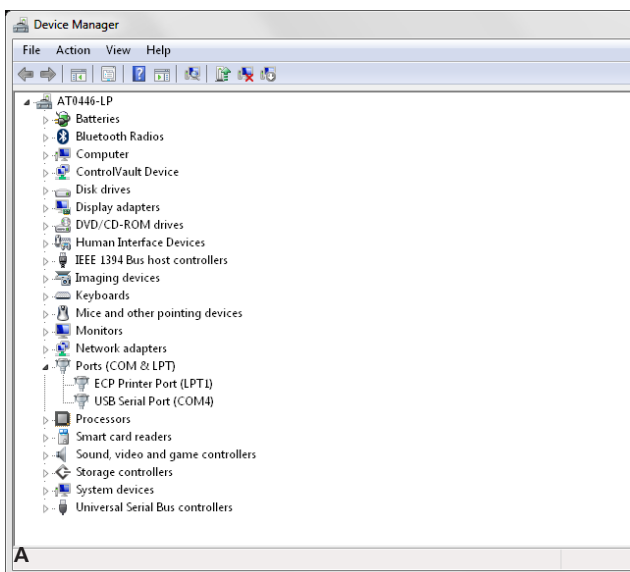



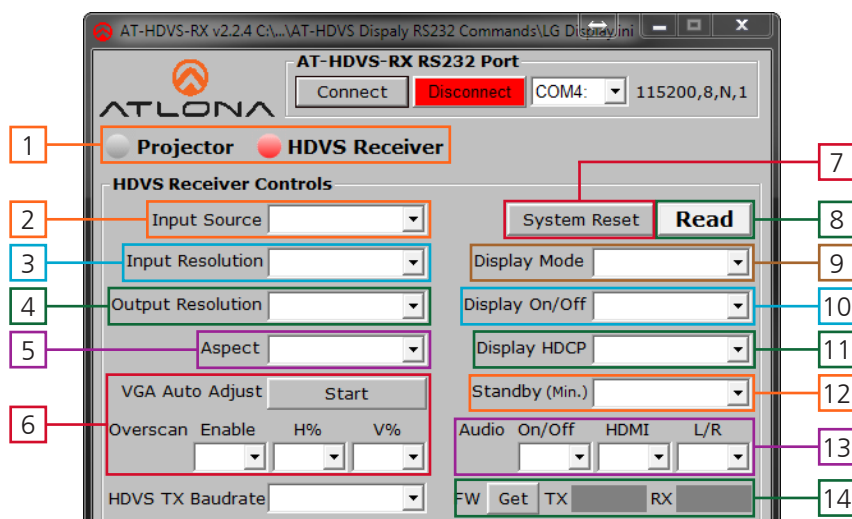

1. **Control** selection: Switch between projector on/off controls and the HDVS-RX controls
2. **Input Source** selection: Choose between the HDMI and VGA ports
3. **Input Resolution**: Switch between the preferred resolutions  
800x600, 1024x768, 1280x720, 1280x800, 1366x768, 1920x1080, 1920x1200
4. **Output Resolution**: Switch between the output resolutions and native resolution  
VESA: 1024x768, 1280x800, 1280x1024, 1366x768, 1400x1050, 1600x1200, 1680x1050, 1920x1200  
Video: 720p@30/50/59.94/60, 1080i@50/59.95/60, 1080p@24/25/29.97/30/50/59.94/60
5. **Aspect**: Changes the HDVS's ratio to work with the connected display
6. **VGA Auto Adjust** and **Overscan**: Adjust the picture timing and positioning on the display  
**Note**: It is recommended to set the HDVS to 0% for PCs and Overscan for BluRay players
7. **HDVS TX Baudrate**: Toggles the HDVS-150-TX's baudrate between 9600 and 115200
7. **System Reset**: Sets the HDVS back to the default settings  
**Note**: Saving (see page 9) is recommended before using the system reset
8. **Read**: Displays the current HDVS settings
9. **Display Mode**: Display on/off button operation selection for the HDVS-TX/TX-WP  
DispSW AVon - Display switches on/off, source audio/video signal always on (default)  
DispSW AVSW - Display switches on/off, source audio/video signal switches on/off  
AV SW - Display is always on, source audio/video signal switches on/off  
Always On - No function  
**Note**: Must be in DispSW AVon or DispSW AVSW for RS-232 display control to work
10. **Display On/Off**: Video signal to display is turned on/off
11. **Display HDCP**: set HDCP reporting to Compliant, Non-compliant, or Auto  
Compliant - Tells the source it is connected to an HDCP compliant device  
Noncompliant - Tells the source it is connected to an HDCP noncompliant device  
Auto - Will report compliant or noncompliant to the source depending on what the display reports.
12. **Standby (Min.)**: select how long it takes before the RX goes into standby  
Adjusts period of time before the scaler goes into standby following loss of signal. Default has standby mode off  
**Note**: Standby must be active for Display Off to work - Standby time will set display off time as well.
13. **Audio**:  
On/Off - Use to turn all audio on and off  
HDMI - Use to toggle HDMI output audio on/off  
L/R - Turn analog audio output on and off
14. **FW**: Press the "GET" button to display the current firmware of the RX and TX units





1. **Picture settings:** Set the brightness, contrast, saturation, sharpness, and hue for the output  
**Note:** Calibrate the display before using the HDVS-150-RX picture settings to adjust the output
2. **Read:** Press to populate the HDVS settings
3. **Reset:** Resets the picture to factory default settings

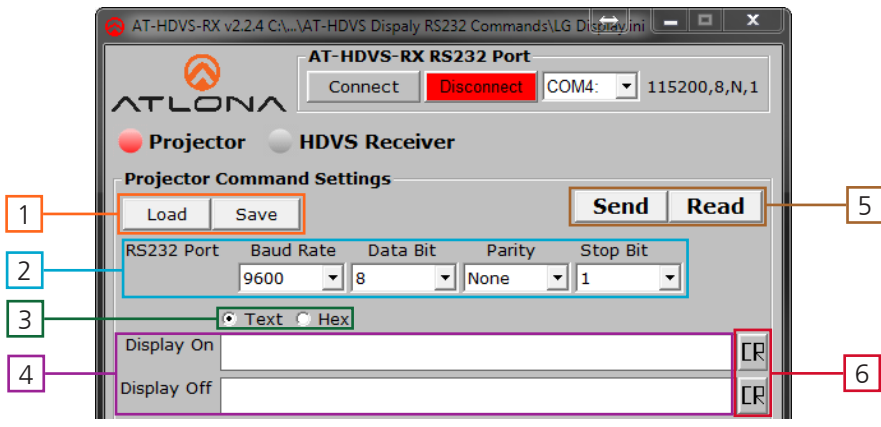

1. **Save:** Allows a display's RS-232 settings to be saved to the PC for easy set up in the future  
**Load:** A previously saved display's settings from your PC
2. **RS-232 port:** Set to display's port settings  
 (See display's manual for the recommended device settings)
3. Select between text (ASCII) and hex commands input for display on and off
4. Type commands for display on and display off in these fields
5. **Send:** Once the information is entered, press send to transmit command to RX to set up control  
**Read:** Verifies commands are correctly stored on the HDVS-RX
6. Use these buttons to add a carriage return at the end of the command  
**Note:** Carriage return will show a square and circle to confirm the carriage return (see picture A)  
**Note:** When switching back to text, any non-ASCII HEX will display as bullets (see picture B)

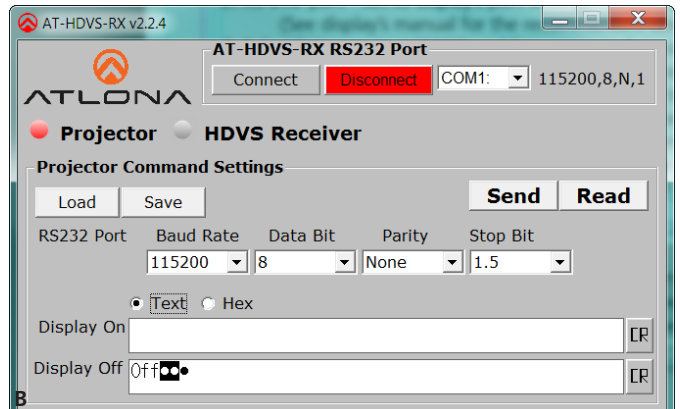
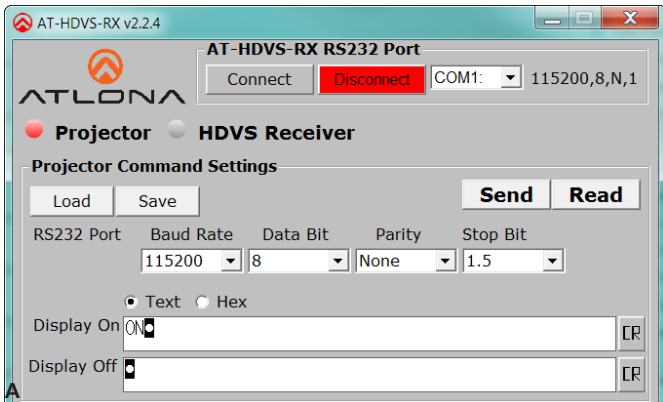

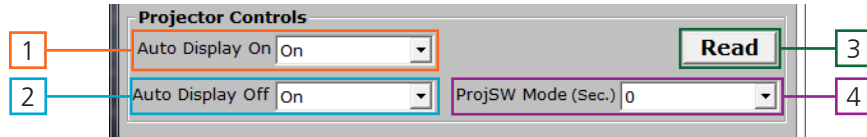

1. **Auto Display On:** Select on or off  
On - Turns the display on when a source is detected
2. **Auto Display Off:** Select on or off  
On - Turns the display off when no signal has been detected for the amount of time selected under standby mode
3. **Read:** displays the current settings
4. **ProjSW mode (Sec.):** Locks the front panel keys (after display off command) for the amount of time specified. Sets time from 0 to 300 seconds (in increments of 5)

### Commands

The command codes are case sensitive, do not change capitalization, spacing, or lettering.

Command	Parameters	Description
WP_DisplaySet[a,b,c,d]\$ WP_DisplaySet[?]\$	<b>[a]</b> baud rate: 2400 , 9600 , 19200 , 38400 , 56000 , 57600 , 115200 <b>[b]</b> data bit: 5 , 6 , 7 , 8 <b>[c]</b> parity: N (None) , O (Odd) , E (Even) , M (Mark) , S (Space) <b>[d]</b> stop bit: 1 , 1.5 , 2	Set projector's RS-232 port
WP_DisplayOn[a,b]\$ WP_DisplayOn[?]\$	<b>[a]</b> command length. carriage return is computed, if it has one. Max. command length is 50 <b>[b]</b> command string. Include carriage return, if it has one. Supports multi-command in a command string. Supports delay-command COMMA (a comma=5 sec)	Set projector's Display On command
WP_DisplayOff[a,b]\$ WP_DisplayOff[?]\$	<b>[a]</b> command length. carriage return is computed, if it has one. Max. command length is 50 <b>[b]</b> command string. Include carriage return, if it has one Supports multi-command in a command string. Supports delay-command COMMA (a comma=5 sec)	Set projector's Display Off command
WP_IdentifyTx[a]\$	<b>[a]</b> ?	Identify Tx model; reply TX=AT-HDVS-TX, TXWP=AT-HDVS-TX-WP
WP_Input[a]\$	<b>[a]</b> ? , Hdmi1 , Hdmi2 , Vga	Select input source
WP_Input[a]\$	<b>[a]</b> ? , Hdmi , Vga	Select input source
WP_InputPrefer[a]\$	<b>[a]</b> ? , 0 , 1 , 2 ... *	Select preferred input resolution
WP_Display[a]\$	<b>[a]</b> ? , On , Off	Display On/Off control
WP_DisplayMode[a]\$	<b>[a]</b> ? , DispSWAVOn , DispSWAVSW , AVSW , AlwaysOn	Set display mode
WP_Aspect[a]\$	<b>[a]</b> ? , Full , 16:9 , 16:10 , 4:3 , Keep	Select output aspect ratio
WP_AutoSwitch[a]\$	<b>[a]</b> ? , On , Off	Input Auto Switch enable/disable

**Input Resolutions:** 0 = 800x600, 1 = 1024x768, 2 = 1280x720, 3 = 1280x800,  
4 = 1366x768, 5 = 1920x1080, 6 = 1920x1200

## Commands cont.

WP_AutoDispOn[a]\$	[a] ? , On , Off	Set auto [Dispaly On] enable/disable
WP_AutoDispOff[a]\$	[a] ? , On , Off	Set auto [Dispaly Off] enable/disable
WP_Hdcplnput[a]\$	[a] ? , HDCP , NotHDCP , Auto	HDCP input mode
WP_VgaAuto[a]\$	[a] Go	Run VGA source auto-adjust
WP_VgaClock[a]\$	[a] ? , Normal , Inverse	Set VGA ADC clock polarity
WP_Info[a]\$	[a] ?	Get RX firmware version
WP_InfoTx[a]\$	[a] ?	Get TX / TX-WP firmware version
WP_Output[a]\$	[a] ? , 0 , 1 , 2 ... (map osd menu Output list)	Select output resolution
WP_OverscanEn[a]\$	[a] ? , Yes , No	Set overscan enable/disable
WP_OverscanH[a]\$	[a] ? , 0 ~ 50	Set overscan H size (%)
WP_OverscanV[a]\$	[a] ? , 0 ~ 50	Set overscan V size (%)
WP_AudioEn[a]\$	[a] ? , On , Off	Set audio out On/Off
WP_AudioHdmi[a]\$	[a] ? , On , Off	Set hdmi audio out On/Off
WP_AudioLR[a]\$	[a] ? , On , Off	Set analog L/R audio out On/Off
WP_SystemRst[a]\$	[a] Go	Run system reset
WP_PictureBri[a]\$	[a] ? , + , - , 0 ~ 100	Set picture brightness
WP_PictureCon[a]\$	[a] ? , + , - , 0 ~ 100	Set picture contrast
WP_PictureSat[a]\$	[a] ? , + , - , 0 ~ 100	Set picture saturation
WP_PictureHue[a]\$	[a] ? , + , - , 0 ~ 100	Set picture hue
WP_PictureSha[a]\$	[a] ? , + , - , 0 ~ 100	Set picture sharpness
WP_PictureRst[a]\$	[a] Go	Run picture reset
WP_ProjSW[a]\$	[a] ? , 0 , 5 , 10 , ~ 300	
WP_Standby[a]\$	[a] ? , 0 ~ 10	Standby timer in minute
]\$		Abort command, Feedback is COMMAND FAIL

### Note:

1. Each command and feedback is terminated with a carriage return.
2. Spaces aren't allowed except in projector display on/off command strings.
3. AT-HDVS-150-RX RS-232 port settings:  
115200 bps, 8 bit data length, No parity bit, 1 bit stop-bit, No flow control.
4. Feedback for a command repeats the original command.
5. If a command fails or is aborted, the feedback will be "COMMAND FAIL".
6. Some commands support query function by parameter [?]  
Example: To get projector's display on command -> WP\_DisplayOn[?]  
To get input status -> WP\_Input[?]

## HDCP Reporting

The HDVS-RX has three HDCP reporting modes: compliant, noncompliant, and auto.

**Note:** HDVS-150 does not alter the signal in any way

**Note:** HDVS-150 will not pass HDCP compliant content to a non-HDCP device or display

### Compliant

Reports to the source it is connected to an HDCP compliant device

**Note:** Will pass all HDCP compliant and non-compliant source signals to an HDCP compliant display

### Non-Compliant

Reports to the source it is connected to an HDCP non-compliant device

**Note:** Some Apple products (and other PCs) will encrypt non-HDCP content, stopping non-HDCP compliant displays from receiving even personal files such as: PowerPoint, Excel, or Word files. Use this mode to pass non-HDCP content (**e.g.** to codecs or video streaming devices)

**Note:** Blu-Ray content, Apple TV, and other HDCP compliant source signals will not pass when set to non-compliant

### Auto

Will report compliant or noncompliant to the source depending on what the display reports.

**Note:** This mode is made to work with direct connection to a display and will not work with Atlona matrices

## Connection and Installation

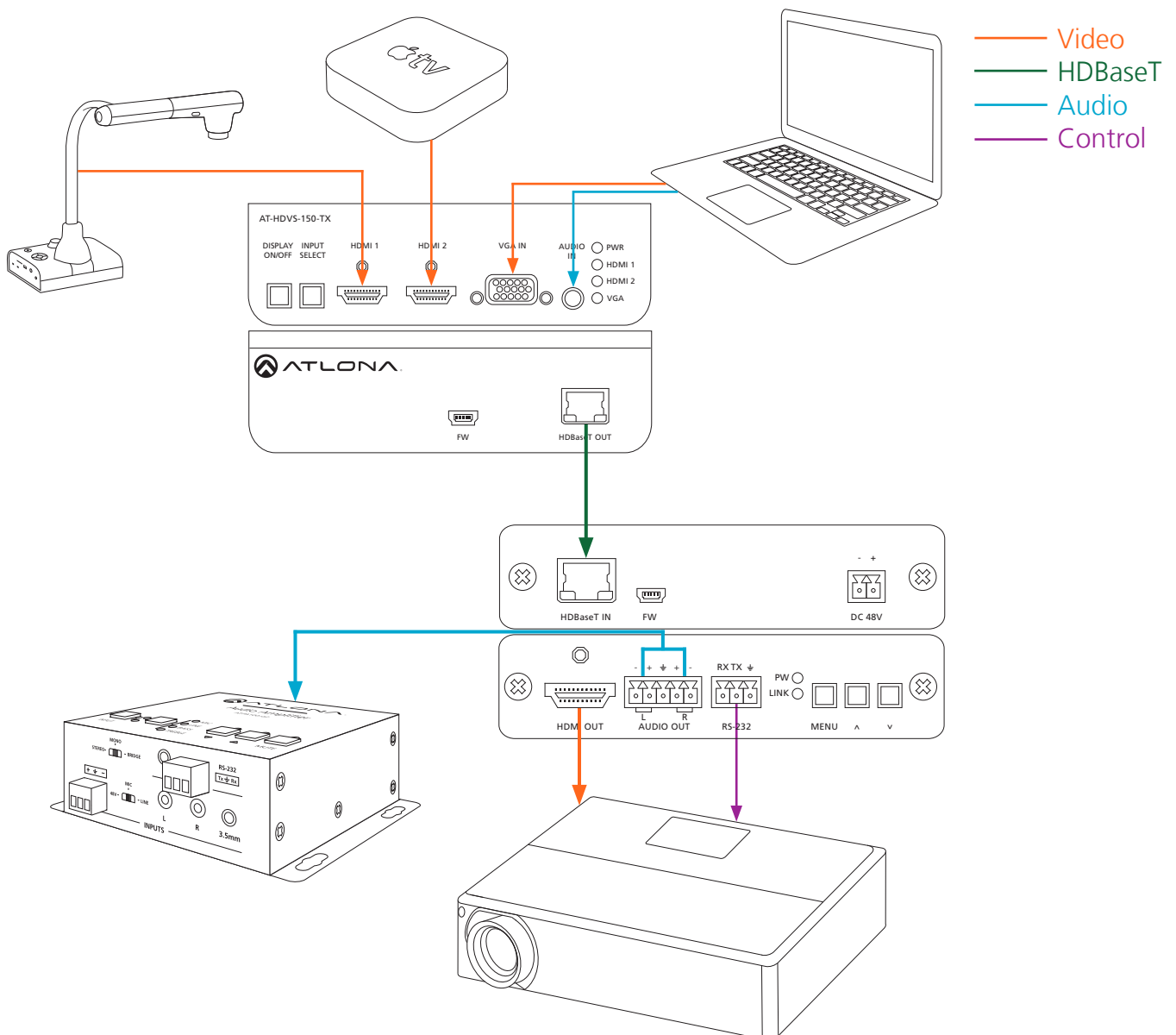

## Specifications

### Video Resolutions

IN	480i, 480p, 576i, 576p, 720p@25/29/30/50/59/60Hz, 1080i@50/59/60Hz, 1080p@23/24/25/29/30/50/59/60Hz
	640x480, 720x400, 800x600, 1024x768, 1152x864, 1280x768, 1280x800, 1280x960, 1280x1024, 1366x768, 1400x1050 1440x900, 1600x900, 1600x1200, 1680x1050, 1920x1200RB
OUT	1080p@23/24/25/29/30/50/59/60, 1080i@50/59/60, 720p@25/29/30/50/59/60
	1920x1200RB, 1680x1050, 1600x1200, 1600x900RB, 1400x1050, 1366x768, 1280x1024, 1280x800, 1024x768, 800x600
Colorspace	RGB, YCbCr 444, YCbCr 422
Color Depth	10-bit, 12-bit, 16-bit

### Audio

Analog OUT	PCM 2Ch
HDMI / HDBaseT	PCM 2Ch, LPCM 5.1, LPCM 7.1, Dolby Digital, DTS 5.1, Dolby Digital Plus, Dolby TrueHD
Sample Rate	44.1kHz, 48kHz, 96kHz, 192kHz

### Distance

HDMI	10 m	30 ft
CAT5e/6	60 m	197 ft
CAT6a/7	70 m	230 ft

### Signal

Bandwidth	6.75 Gbps
CEC	No
HDCP	Compliant

### Temperature

Operating	0°C to 40°C	32°F to 104°F
Storage	-20°C to 60°C	-4°F to 140°F
Humidity	20 to 90% non-condensing	

### Power

Consumption	15W (varies per paired transmitter)
Supply	Input: AC100-240V ~ 50/60Hz Output: DC 48V/0.83A

### Dimension

H x W x D	30 x 122 x 125 (mm)	1.18 x 4.8 x 4.92 (inch)
-----------	---------------------	--------------------------

### Weight

Device	0.31 kg	0.67 lbs
--------	---------	----------

### Certification

Unit	CE, FCC
Power Supply	CE, FCC, Level VI, RoHS, cULus, RCM, CCC

**Note:** To ensure compatibility, please be certain both transmitter and receiver have blue HDBaseT ports. This ensures both products are PoE (48V) compliant. The HDVS-200-TX is not compatible with PoCC (black RJ45, 24V) devices

## Safety Information

### Safeguards



To reduce the risk of electric shock, do not expose this product to rain or moisture



Do not modify the wall plug. Doing so will void the warranty and safety features.



If the wall plug does not fit into your local power socket, hire an electrician to replace your obsolete socket.



This equipment should be installed near the socket outlet and the device should be easily accessible in the case it requires disconnection.

### Precautions

FCC regulations state that any unauthorized changes or modifications to this equipment, not expressly approved by the manufacturer, could void the user's authority to operate this equipment.

Operate this product using only the included external power supply. Use of other power supplies could impair performance, damage the product, or cause fires.

In the event of an electrostatic discharge this device may automatically turn off. If this occurs, unplug the device and plug it back in.

Protect and route power cords so they will not be stepped on or pinched by anything placed on or against them. Be especially careful of plug-ins or cord exit points from this product.

Avoid excessive humidity, sudden temperature changes or temperature extremes.

Keep this product away from wet locations such as bathtubs, sinks, laundries, wet basements, fish tanks, and swimming pools.

Use only accessories recommended by Atlona to avoid fire, shock, or other hazards.

Unplug the product before cleaning. Use a damp cloth for cleaning and not cleaning fluid or aerosols. Such products could enter the unit and cause damage, fire, or electric shock. Some substances may also mar the finish of the product.

Never open, remove unit panels, or make any adjustments not described in this manual. Attempting to do so could expose you to dangerous electrical shock or other hazards. It may also cause damage to your product. Opening the product will void the warranty.

Do not attempt to service the unit. Disconnect the product and contact your authorized Atlona reseller or contact Atlona directly.



## Atlona, Inc. ("Atlona") Limited Product Warranty Policy

### Coverage

Atlona warrants its products will substantially perform to their published specifications and will be free from defects in materials and workmanship under normal use, conditions and service.

Under its Limited Product Warranty, Atlona, at its sole discretion, will either:

- A) repair or facilitate the repair of defective products within a reasonable period of time, restore products to their proper operating condition and return defective products free of any charge for necessary parts, labor and shipping
- OR**
- B) replace and return, free of charge, any defective products with direct replacement or with similar products deemed by Atlona to perform substantially the same function as the original products
- OR**
- C) refund the pro-rated value based on the remaining term of the warranty period, not to exceed MSRP, in cases where products are beyond repair and/or no direct or substantially similar replacement products exist.

Repair, replacement or refund of Atlona's products is the purchaser's exclusive remedy and Atlona's liability does not extend to any other damages, incidental, consequential or otherwise.

This Limited Product Warranty extends to the original end-user purchaser of Atlona's products and is non-transferrable to any subsequent purchaser(s) or owner(s) of these products.

### Coverage Periods

Atlona's Limited Product Warranty Period begins on the date of purchase by the end-purchaser. The date contained on the end-purchaser's sales or delivery receipt is the proof purchase date.

#### **Limited Product Warranty Terms – New Products**

- 10 years from proof of purchase date for hardware/electronics products purchased on or after June 1, 2013
- 3 years from proof of purchase date for hardware/electronics products purchased before June 1, 2013
- Lifetime Limited Product Warranty for all cable products

#### **Limited Product Warranty Terms – Refurbished (B-Stock) Products**

- 3 years from proof of purchase date for all Refurbished (B-Stock) hardware and electronic products purchased on or after June 1, 2013

### Remedy

Atlona recommends that end-purchasers contact their authorized Atlona dealer or reseller from whom they purchased their products. Atlona can also be contacted directly. Visit [www.atlona.com](http://www.atlona.com) for Atlona's contact information and hours of operation. Atlona requires that a dated sales or delivery receipt from an authorized dealer, reseller or end-purchaser is provided before Atlona extends its warranty services. Additionally, a return merchandise authorization (RMA) and/or case number, is required to be obtained from Atlona in advance of returns.

Atlona requires that products returned are properly packed, preferably in the original carton, for shipping. Cartons not bearing a return authorization or case number will be refused. Atlona, at its sole discretion, reserves the right to reject any products received without advanced authorization. Authorizations can be requested by calling 1-877-536-3976 (US toll free) or 1-408-962-0515 (US/international) or via Atlona's website at [www.atlona.com](http://www.atlona.com).

### Exclusions

This Limited Product Warranty excludes:

- Damage, deterioration or malfunction caused by any alteration, modification, improper use, neglect, improper packing or shipping (such claims must be presented to the carrier), lightning, power surges, or other acts of nature.
- Damage, deterioration or malfunction resulting from the installation or removal of this product from any installation, any unauthorized tampering with this product, any repairs attempted by anyone unauthorized by Atlona to make such repairs, or any other cause which does not relate directly to a defect in materials and/or workmanship of this product.
- Equipment enclosures, cables, power supplies, batteries, LCD displays, and any accessories used in conjunction with the product(s).
- Products purchased from unauthorized distributors, dealers, resellers, auction websites and similar unauthorized channels of distribution.

### **Disclaimers**

This Limited Product Warranty does not imply that the electronic components contained within Atlona's products will not become obsolete nor does it imply Atlona products or their electronic components will remain compatible with any other current product, technology or any future products or technologies in which Atlona's products may be used in conjunction with. Atlona, at its sole discretion, reserves the right not to extend its warranty offering in instances arising outside its normal course of business including, but not limited to, damage inflicted to its products from acts of god.

### **Limitation on Liability**

The maximum liability of Atlona under this limited product warranty shall not exceed the original Atlona MSRP for its products. To the maximum extent permitted by law, Atlona is not responsible for the direct, special, incidental or consequential damages resulting from any breach of warranty or condition, or under any other legal theory. Some countries, districts or states do not allow the exclusion or limitation of relief, special, incidental, consequential or indirect damages, or the limitation of liability to specified amounts, so the above limitations or exclusions may not apply to you.

### **Exclusive Remedy**

To the maximum extent permitted by law, this limited product warranty and the remedies set forth above are exclusive and in lieu of all other warranties, remedies and conditions, whether oral or written, express or implied. To the maximum extent permitted by law, Atlona specifically disclaims all implied warranties, including, without limitation, warranties of merchantability and fitness for a particular purpose. If Atlona cannot lawfully disclaim or exclude implied warranties under applicable law, then all implied warranties covering its products including warranties of merchantability and fitness for a particular purpose, shall provide to its products under applicable law. If any product to which this limited warranty applies is a "Consumer Product" under the Magnuson-Moss Warranty Act (15 U.S.C.A. §2301, ET SEQ.) or other applicable law, the foregoing disclaimer of implied warranties shall not apply, and all implied warranties on its products, including warranties of merchantability and fitness for the particular purpose, shall apply as provided under applicable law.

### **Other Conditions**

Atlona's Limited Product Warranty offering gives legal rights, and other rights may apply and vary from country to country or state to state. This limited warranty is void if (i) the label bearing the serial number of products have been removed or defaced, (ii) products are not purchased from an authorized Atlona dealer or reseller. A comprehensive list of Atlona's authorized distributors, dealers and resellers can be found at [www.atlona.com](http://www.atlona.com).

## **Atlona, Inc Product Registration**

Thank you for purchasing this Atlona product. - We hope you enjoy it and will take an extra few moments to register your new purchase.

Registration creates an ownership record if your product is lost or stolen and helps ensure you'll receive notification of performance issues and firmware updates.

At Atlona we respect and protect your privacy, assuring you that your registration information is completely secure. Atlona product registration is completely voluntary and failure to register will not diminish your limited warranty rights.

To register go to: <http://www.atlona.com/registration>