

RT10

RUGGED 10-INCH TABLET

Configuration Guide



THE
FUTURE
IS
WHAT
WE
MAKE IT

Honeywell

TABLE OF CONTENTS

- 2 RT10 FEATURE OVERVIEW**
 - INDOOR DISPLAY - N6703 STANDARD RANGE
 - OUTDOOR DISPLAY - N6703 STANDARD RANGE
 - INDOOR DISPLAY - N6803 FLEXRANGE™
 - OUTDOOR DISPLAY - N6803 FLEXRANGE™

- 6 RT10 CONFIGURATION MAP**
 - ANDROID
 - WINDOWS 10 IOT ENTERPRISE

- 8 HONEYWELL EDGE SERVICES**
 - GOLD REPAIR SERVICES - 3 YEAR
 - PLATINUM REPAIR SERVICES - 3 YEAR
 - GOLD REPAIR SERVICES - 5 YEAR
 - PLATINUM REPAIR SERVICES - 5 YEAR
 - RT10 - REPAIR SERVICES COVERAGE

- 11 RT10 SOFTWARE**
 - RT10 CLIENT PACK OPTIONS

- 12 RT10 DESKTOP COMMUNICATIONS**
 - OPTION 1 – PORTABLE
 - OPTION 2 – FIXED - COMMUNICATIONS DOCK
 - OPTION 3 - DISPLAY DOCK

- 14 RT10 VEHICLE INSTALL**
 - OPTION 1 - PORTABLE/ SUB CONTRACTOR INSTALL
 - OPTION 2 - PORTABLE/ SUB CONTRACTOR INSTALL
 - VEHICLE DOCK OPTIONS
 - VEHICLE DOCK 360 DEGREE VIEW
 - POWER ADAPTER CABLE

- 19 RT10 FORKLIFT INSTALL**
 - OPTION 1 - WWAN - KEYBOARD - TETHERED SCANNER
 - OPTION 2 - WWAN - KEYBOARD - BLUETOOTH SCANNER
 - OPTION 3 - WWAN - TETHERED SCANNER
 - OPTION 4 - WWAN - BLUETOOTH SCANNER

- 23 RT10 PORTS**
 - RT10W AND RT10A I/O PORTS

- 24 RT10 BATTERY PACK**
 - STANDARD OR EXTENDED BATTERY

- 25 RT10 BATTERY CHARGER**
 - 2 BAY BATTERY CHARGING

- 26 RT10 ACCESSORIES**
 - SMART CARD READER

- 27 RT10 VESA MOUNT**
 - STATIONARY MOUNTING

- 28 GRANIT SCANNER OPTIONS**
 - GRANIT 1981I BLUETOOTH ACCESSORIES
 - GRANIT 1980I - SERIAL CABLE TYPES
 - GRANIT 1980I - USB CABLE TYPES

- 31 MISCELLANEOUS**
 - HAND STRAP
 - SHOULDER STRAP
 - STYLUS
 - CARRY BAG
 - OPTIONAL PARTS
 - MICRO-SD CARDS
 - AC CORDS

RT10 FEATURE OVERVIEW

Indoor Display - N6703 Standard Range

**INDOOR
800 NIT**

Display



4G LTE / GPS



WiFi / BT

**N6703
7th GEN**

Scanner



N6703 Standard Range

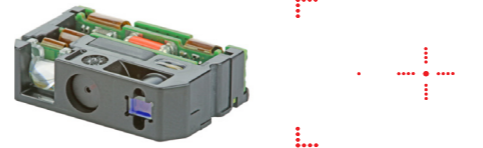

Included in the box:

- RT10 Rugged Tablet
- Battery (RT10-BAT-STD1)
- Stylus
- RT10A - USB Type C Cable
- AC Power Supply (No Power Cord)

(AC Power Cord is required, order separately RT10-PWR-CABLE-xx See Page 34 for Country Specific Power Cords)



RT10W - Windows 10 - 4G WWAN - N6703 - 8GB RAM/ 128GB SSD

RT10W-L10-17C12S0x RT10W 10 inch Windows Rugged Tablet / 8GB/128GB / WWAN / Standard/Indoor Screen / N6703 Standard Range Imager / Front & Rear Cameras / Standard Battery / Windows 10 IoT Enterprise / 802.11abgnac / Bluetooth / Enterprise Client Pack (ECP), No Power Cord

RT10W - Windows 10 - WiFi Only - N6703 - 8GB RAM/ 128GB SSD

RT10W-L00-17C12S0x RT10W 10 inch Windows Rugged Tablet / 8GB/128GB / WLAN / Standard/Indoor Screen / N6703 Standard Range Imager / Front & Rear Cameras / Standard Battery / Windows 10 IoT Enterprise / 802.11abgnac / Bluetooth / Enterprise Client Pack (ECP), No Power Cord

RT10A - Android - 4G WWAN - N6703 - 4GB RAM/ 32GB Flash

RT10A-L1N-17C12S0x RT10A 10 inch Android Rugged Tablet / WWAN / Standard/Indoor Screen / N6703 Standard Range Imager / Front & Rear Cameras / Standard Battery / Android GMS / DCP (Device Client Pack) / 802.11abgnac / Bluetooth, No Power Cord

RT10A - Android - WiFi Only - N6703 - 4GB RAM/ 32GB Flash

RT10A-L0N-17C12S0x RT10A 10 inch Android Rugged Tablet / WLAN / Standard/Indoor Screen / N6703 Standard Range Imager / Front & Rear Cameras / Standard Battery / Android GMS / DCP (Device Client Pack) / 802.11abgnac / Bluetooth, No Power Cord

(Note: x = Domain, select appropriate Domain from Configuration Map on pages 6 & 7)

Honeywell Repair Services

SVCRT10-SG3N

RT10, Edge Service, Gold Maintenance Contract, 3 Year, New Contract

ADD SVCREPLACE-MOB3

AddOn, Edge Service, Device Replacement, Mobility, 3 Year

RT10 FEATURE OVERVIEW

Outdoor Display - N6703 Standard Range

**OUTDOOR
800 NIT
ANTI-GLARE**

Display



4G LTE / GPS



WiFi / BT

**N6703
7th GEN**

Scanner



N6703 Standard Range

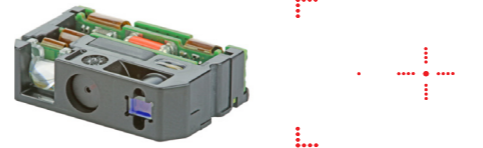

Included in the box:

- RT10 Rugged Tablet
- Battery (RT10-BAT-STD1)
- Stylus
- RT10A - USB Type C Cable
- AC Power Supply (No Power Cord)

(AC Power Cord is required, order separately RT10-PWR-CABLE-xx See Page 34 for Country Specific Power Cords)



RT10W – Windows 10 - 4G WWAN - N6703 - 8GB RAM/ 128GB SSD

RT10W-L10-17C12S1x

RT10W 10 inch Windows Rugged Tablet / 8GB/128GB / WWAN / Outdoor Screen / N6703 Standard Range Imager / Front & Rear Cameras / Standard Battery / Windows 10 IoT Enterprise / 802.11abgnac / Bluetooth / Enterprise Client Pack (ECP), No Power Cord

RT10A – Android - 4G WWAN - N6703 - 4GB RAM/ 32GB Flash

RT10A-L1N-17C12S1x

RT10A 10 inch Android Rugged Tablet / WWAN / Outdoor Screen / N6703 Standard Range Imager / Front & Rear Cameras / Standard Battery / Android GMS / DCP (Device Client Pack) / 802.11abgnac / Bluetooth, No Power Cord

(Note: x = Domain, select appropriate Domain from Configuration Map on pages 6 & 7)

Honeywell Repair Services

SVCRT10-SG3N

RT10, Edge Service, Gold Maintenance Contract, 3 Year, New Contract

ADD SVCREPLACE-MOB3

AddOn, Edge Service, Device Replacement, Mobility, 3 Year

RT10 FEATURE OVERVIEW

Indoor Display – N6803 FlexRange™

**INDOOR
800 NIT**

Display



4G LTE / GPS



WiFi / BT

**N6803
8th GEN**

Scanner



N6803 FlexRange™

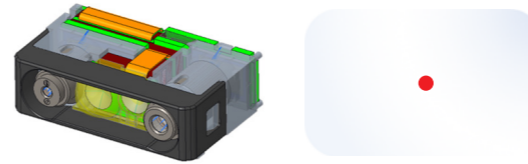

Included in the box:

- RT10 Rugged Tablet
- Battery (RT10-BAT-STD1)
- Stylus
- RT10A - USB Type C Cable
- AC Power Supply (No Power Cord)

(AC Power Cord is required, order separately RT10-PWR-CABLE-xx See Page 34 for Country Specific Power Cords)



RT10W – Windows 10 - 4G WWAN – N6803 FlexRange – 8GB RAM/ 128GB SSD

RT10W-L10-18C12S0x RT10W 10 inch Windows Rugged Tablet / 8GB/128GB / WWAN / Standard/Indoor Screen / N6803 FlexRange Imager / Front & Rear Cameras / Standard Battery / Windows 10 IoT Enterprise / 802.11abgnac / Bluetooth / Enterprise Client Pack (ECP), No Power Cord

RT10W – Windows 10 - WiFi Only – N6803 FlexRange – 8GB RAM/ 128GB SSD

RT10W-L00-18C12S0x RT10W 10 inch Windows Rugged Tablet / 8GB/128GB / WLAN / Standard/Indoor Screen / N6803 FlexRange Imager / Front & Rear Cameras / Standard Battery / Windows 10 IoT Enterprise / 802.11abgnac / Bluetooth / Enterprise Client Pack (ECP), No Power Cord

RT10A – Android - 4G WWAN – N6803 FlexRange – 4GB RAM/ 32GB Flash

RT10A-L1N-18C12S0x RT10A 10 inch Android Rugged Tablet / WWAN / Standard/Indoor Screen / N6803 FlexRange Imager / Front & Rear Cameras / Standard Battery / Android GMS / DCP (Device Client Pack) / 802.11abgnac / Bluetooth, No Power Cord

RT10A – Android - WiFi Only – N6803 FlexRange – 4GB RAM/ 32GB Flash

RT10A-L0N-18C12S0x RT10A 10 inch Android rugged tablet / WLAN / Standard/Indoor Screen / N6803 FlexRange Imager / Front & Rear Cameras / Standard Battery / Android GMS / DCP (Device Client Pack) / 802.11abgnac / Bluetooth, No Power Cord

(Note: x = Domain, select appropriate Domain from Configuration Map on pages 6 & 7)

Honeywell Repair Services

SVCRT10-SG3N

RT10, Edge Service, Gold Maintenance Contract, 3 Year, New Contract

ADD SVCREPLACE-MOB3

AddOn, Edge Service, Device Replacement, Mobility, 3 Year

RT10 FEATURE OVERVIEW

Outdoor Display - N6803 FlexRange™

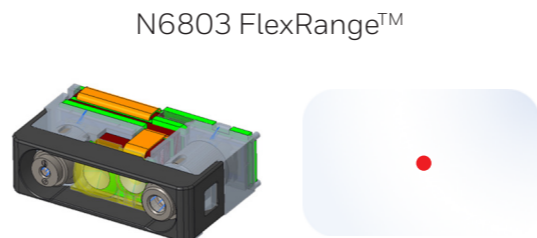

Included in the box:

- RT10 Rugged Tablet
- Battery (RT10-BAT-STD1)
- Stylus
- RT10A - USB Type C Cable
- AC Power Supply (No Power Cord)

(AC Power Cord is required, order separately RT10-PWR-CABLE-xx See Page 34 for Country Specific Power Cords)

RT10W – Windows 10 - 4G WWAN - N6803 FlexRange - 8GB RAM/ 128GB SSD

RT10W-L10-18C12S1x

RT10W 10 inch Windows Rugged Tablet / 8GB/128GB / WWAN / Outdoor Screen / N6803 FlexRange Imager / Front & Rear Cameras / Standard Battery / Windows 10 IoT Enterprise / 802.11abgnac / Bluetooth / Enterprise Client Pack (ECP), No Power Cord

RT10A – Android - 4G WWAN - N6803 FlexRange - 4GB RAM/ 32GB Flash

RT10A-L1N-18C12S1x

RT10A 10 inch Android Rugged Tablet / WWAN / Outdoor Screen / N6803 FlexRange Imager / Front & Rear Cameras / Standard Battery / Android GMS / DCP (Device Client Pack) / 802.11abgnac / Bluetooth, No Power Cord

(Note: x = Domain, select appropriate Domain from Configuration Map on pages 6 & 7)

Honeywell Repair Services

SVCRT10-SG3N



RT10, Edge Service, Gold Maintenance Contract, 3 Year, New Contract

ADD SVCREPLACE-MOB3

AddOn, Edge Service, Device Replacement, Mobility, 3 Year

RT10A CONFIGURATION MAP



Android

RT10A-												DESCRIPTION	NOTES
BLUETOOTH/WIFI	WWAN	NFC	MEMORY	IMAGER	CAMERA	OPERATING-SYSTEM	APPLICATION	BATTERY	CUSTOM	DOMAIN			
L												802.11 a/b/g/n/ac + Bluetooth 5.0	2x2 MIMO IEEE 802.11 a/b/g/n/ac/r/k/mc ; Wi-Fi certified V5.0 Bluetooth and BLE Supported Bluetooth Profiles: HFP,PBAP, A2DP, AVRCP, OPP, SPP, GATT
	0											No WWAN	
	1											LTE (4G) GPS, UMTS/HSPA+ (3G) GSM/GPRS/EDGE	WWAN RADIO (ATT/VZW/SPRINT/TMO/NA/EU) LTE (FDD) – BANDS 1,2,3,4,5,7,8,12,13,17,19,20,25,26,28,29 LTE (TDD) – BANDS 38,39,40,41 UMTS/HSPA+ (3G) – BANDS 1, 2, 4, 5, 6, 8, 9, 19 / GSM/GPRS/EDGE QUAD-BAND (850/900/1800/1900 MHZ)
		N										Near Field Communications (NFC)	
			--										
			1									4GB RAM, 32GB Flash Memory	2.2 GHz Qualcomm Snapdragon™ 660 octa-core
				7								1D/2D Imager (N6703) – Standard Range	
				8								1D/2D Imager (N6803) – FlexRange™	
					C							Camera	8MP Front and 13MP Rear
					N							No Camera	
						1						Android (GMS)	Google Mobile Services (GMS) certified – Play Store
						2						Android (Non-GMS)	
							2					Device Client Pack (DCP)	Enterprise Browser, Basic TE and Honeywell Launcher
								S				Standard Battery	RT10-BAT-STD1 Standard (5,900mAh)
								E				Extended Battery	RT10-BAT-EXT1 Extended (10,280mAh)
									0			Indoor Display 800 NIT Display	
									1			Outdoor Display 800 NIT Display (Anti-Reflective Film)	Anti-Reflective Film is applied at Manufacturing, not field installable.
										C		China	China
										E		World Wide	Argentina, Australia, Austria, Belgium, Brazil, Bulgaria, Columbia, Croatia, Cyprus, Czech Republic, Denmark, Dominican Republic, Egypt, Estonia, Finland, France, Germany, Greece, Honduras, Hong Kong, Iceland, India, Indonesia, Ireland, Italy, Japan, Jordan, Kuwait, Latvia, Liechtenstein, Lithuania, Luxembourg, Malaysia, Malta, Morocco, Netherlands, New Zealand, Norway, Oman, Poland, Portugal, Qatar, Romania, Russia, Saudi Arabia, Singapore, Slovakia, Slovenia, South Africa, South Korea, Spain, Sri Lanka, Sweden, Switzerland, Thailand, UAE, Ukraine, United Kingdom, Vietnam
										F		FCC	USA, Canada, Guatemala, Mexico, Panama, Paraguay, Puerto Rico, Taiwan, Venezuela



RT10W CONFIGURATION MAP

Windows 10 IoT Enterprise

											DESCRIPTION	NOTES		
BLUETOOTH/WIFI	WWAN	NFC	MEMORY	IMAGER	CAMERA	OPERATING SYSTEM	APPLICATION	BATTERY	CUSTOM	DOMAIN				
RT10W-														
L												802.11 a/b/g/n/ac + Bluetooth 5.0		
	0											No WWAN		
		1										LTE (4G) GPS, UMTS/HSPA+ (3G)	WWAN RADIO LTE (FDD) – BANDS 1,2,3,4,5,7,8,12,13,20,25,26,29,30 / LTE (TDD) – BAND 41 UMTS/HSPA+ (3G) – BANDS 1, 2, 3, 4, 5, 8	
			0									No Near Field Communications (NFC)		
				--										
				1								8GB RAM, 128GB SSD	Intel® Pentium® N4200 Apollo Lake Processor 1.10 GHz, up to 2.50 GHz with turbo boost technology	
					7							1D/2D Imager (N6703) – Standard Range		
						8						1D/2D Imager (N6803) – FlexRange™		
							C					Camera	2MP Front and 8MP Rear	
								N				No Camera		
									1			Windows® 10 IoT Enterprise (64-bit)		
										2		Enterprise Client Pack (ECP)	Windows Enterprise Terminal Emulator (ETE) + Launcher + Enterprise Browser	
											S	Standard Battery	RT10-BAT-STD1 Standard (5,900mAh)	
												E	Extended Battery	RT10-BAT-EXT1 Extended (10,280mAh)
												0	Indoor Display 800 NIT Display	
												1	Outdoor Display 800 NIT Display (Anti-Reflective Film)	Anti-Reflective Film is applied at Manufacturing, not field installable.
												C	China	China
												E	World Wide	Argentina, Australia, Austria, Belgium, Brazil, Bulgaria, Columbia, Croatia, Cyprus, Czech Republic, Denmark, Dominican Republic, Egypt, Estonia, Finland, France, Germany, Greece, Honduras, Hong Kong, Iceland, India, Indonesia, Ireland, Italy, Japan, Jordan, Kuwait, Latvia, Liechtenstein, Lithuania, Luxembourg, Malaysia, Malta, Morocco, Netherlands, New Zealand, Norway, Oman, Poland, Portugal, Qatar, Romania, Russia, Saudi Arabia, Singapore, Slovakia, Slovenia, South Africa, South Korea, Spain, Sri Lanka, Sweden, Switzerland, Thailand, UAE, Ukraine, United Kingdom, Vietnam
												F	FCC	USA, Canada, Guatemala, Mexico, Panama, Paraguay, Puerto Rico, Taiwan, Venezuela



HONEYWELL EDGE SERVICES

RT10 – Repair Services

Honeywell Edge Services give you the confidence of having leading-class technologies combined with service and support plans that are designed to keep you operational for longer.

Gold Repair Services – 3 Year

The most flexible contract in the industry. The Edge Services Gold Support contract allows you to select the right coverage for your organization, and includes 5-Day Depot Repairs and:

Service Overview

- Repair or replacement of damaged components, wear and tear, and accidental damage.
- Flexibility to add any Add-On Service

PART NUMBER	DESCRIPTION
SVCRT10-SG3N	RT10, Edge Service, GOLD Maintenance Contract, 5 Day Turnaround, 3 Year , New Contract

Add-On Accessory Replacement Service

Provides replacement chargers, docks, charging cables, or scan handles should they be damaged or stop working.

ADD SVCACC-MOB3	AddOn, Edge Service, Accessory Service , Mobility, 3 Year . Service covers docks, charger cradles, scan handles
------------------------	--

Add-On Battery Replacement Service

Provides replacement batteries every 18 months after purchase.

ADD SVCBATTERY-MOB3	AddOn, Edge Service, Battery Service, Mobility, 3 Year , 1 Replacement Battery over life of contract
----------------------------	---

Add-On Device Replacement Service

Replacement devices should a device be damaged beyond repair.

ADD SVCREPLACE-MOB3	AddOn, Edge Service, Device Replacement, Mobility, 3 Year
----------------------------	--

Add-On Image Management Service

Ensures that when a device returns from being repaired, it has all the proper applications loaded back on the device.

ADD SVCIMAGEMGMT-MOB3	AddOn, Edge Service, Image Service, Mobility, 3 Year
------------------------------	---

Add-On Spare Management Service

Manages every aspect of your spare pool.

ADD SVCSPAREMGMT-MOB3	AddOn, Edge Service, Advanced Exchange, Mobility, 3 Year . Customer owned spare pool, Minimum Purchase required, contact your local Honeywell Service Representative for more information.
------------------------------	---

Add-On Sentinel Extended Service

Security patches and minor enhancements to legacy Android operating systems, typically added after year 3.

ADD SVCSENTINEL-MOB1	Sentinel Service, 1 Year Android Support Contract
-----------------------------	--

ADD SVCSENTINEL-MOB2	Sentinel Service, 2 Year Android Support Contract
-----------------------------	--

Platinum Repair Services – 3 Year

The Edge Services Platinum Support contract is the only total support contract in the industry today offering 2-Day Depot Repairs or Spare Pool Management with 3-year contract, that includes:

Service Overview

- Repair or replacement of damaged components
- SVCREPLACE-MOB3 - Replacement devices should a device be damaged beyond repair
- SVCACC-MOB3 - Accessory replacement service
- SVCBATTERY-MOB3 - Battery replacement service
- PPSW-OPINTEL-PMP36 - Operational Intelligence Performance Professional licenses
- SVCSPAREMGMT-MOB3 - Spare pool management (optional, minimum quantity required)
- Telephone-based technical support
- Sentinel Extended Service that protects customers for future security updates on Android.

PART NUMBER	DESCRIPTION
SVCRT10-SP3N	RT10, Edge Service, PLATINUM, 2 Day Turnaround, 3 Year, New Contract

OPERATIONAL INTELLIGENCE SETUP MUST BE ORDERED WITH PLATINUM EDGE SERVICE CONTRACT

RT10A PPPS-OIPLI-SETUP	OpIntel Free Platinum Installation Basic & Professional
-------------------------------	---



HONEYWELL EDGE SERVICES

RT10 – Repair Services

Honeywell Edge Services give you the confidence of having leading-class technologies combined with service and support plans that are designed to keep you operational for longer.

Gold Repair Services – 5 Year

The most flexible contract in the industry. The Edge Services Gold Support contract allows you to select the right coverage for your organization, and includes 5-Day Depot Repairs and:

Service Overview

- Repair or replacement of damaged components, wear and tear, and accidental damage.
- Flexibility to add any Add-On Service

PART NUMBER	DESCRIPTION
SVCRT10-SG5N	RT10, Edge Service, GOLD Maintenance Contract, 5 Day Turnaround, 5 Year , New Contract

Add-On Accessory Replacement Service

Provides replacement chargers, docks, charging cables, or scan handles should they be damaged or stop working.

ADD SVCACC-MOB5	AddOn, Edge Service, Accessory Service , Mobility, 5 Year . Service covers docks, charger cradles, scan handles
------------------------	--

Add-On Battery Replacement Service

Provides replacement batteries every 18 months after purchase.

ADD SVCBATTERY-MOB5	AddOn, Edge Service, Battery Service, Mobility, 5 Year , 2 Replacement Battery over life of contract
----------------------------	---

Add-On Device Replacement Service

Replacement devices should a device be damaged beyond repair.

ADD SVCREPLACE-MOB5	AddOn, Edge Service, Device Replacement, Mobility, 5 Year
----------------------------	--

Add-On Image Management Service

Ensures that when a device returns from being repaired, it has all the proper applications loaded back on the device.

ADD SVCIMAGEMGMT-MOB5	AddOn, Edge Service, Image Service, Mobility, 5 Year
------------------------------	---

Add-On Spare Management Service

Manages every aspect of your spare pool.

ADD SVCSPAREMGMT-MOB5	AddOn, Edge Service, Advanced Exchange, Mobility, 5 Year . Customer owned spare pool, Minimum Purchase required, contact your local Honeywell Service Representative for more information.
------------------------------	---

Add-On Sentinel Extended Service

Security patches and minor enhancements to legacy Android operating systems, typically added after year 3.

ADD SVCSENTINEL-MOB1	Sentinel Service, 1 Year Android Support Contract
ADD SVCSENTINEL-MOB2	Sentinel Service, 2 Year Android Support Contract

Platinum Repair Services – 5 Year

The Edge Services Platinum Support contract is the only total support contract in the industry today offering 2-Day Depot Repairs or Spare Pool Management with 5-year contract, that includes:

Service Overview

- Repair or replacement of damaged components
- SVCREPLACE-MOB5 - Replacement devices should a device be damaged beyond repair
- SVCACC-MOB5 - Accessory replacement service
- SVCBATTERY-MOB5 - Battery replacement service
- PPSW-OPINTEL-PMP60 - Operational Intelligence Performance Professional licenses
- SVCSPAREMGMT-MOB5 - Spare pool management (optional, minimum quantity required)
- Telephone-based technical support
- Sentinel Extended Service that protects customers for future security updates on Android. RT10A - The 5 year Sentinel coverage provides extended Android updates in years 4 and 5.

PART NUMBER	DESCRIPTION
SVCRT10-SP5N	RT10, Edge Service, PLATINUM, 2 Day Turnaround, 5 Year, New Contract
OPERATIONAL INTELLIGENCE SETUP MUST BE ORDERED WITH PLATINUM EDGE SERVICE CONTRACT	
RT10A PPPS-OIPLI-SETUP	OpIntel Free Platinum Installation Basic & Professional



HONEYWELL REPAIR SERVICES

RT10 – Repair Services Coverage

For Best-In-Class Service

RT10



Warranty Cover Against Product Defect

BASIC Service

Gold Coverage:

- Accidental Damage
- Wear & Tear

Includes Replacement of:

- Stylus



Flexible GOLD Add-Ons ordered separately

- SVCACC-MOB3 Accessories
- SVCBATTERY-MOB3 Batteries
- SVCREPLACE-MOB3 Device Replacement
- SVCIMAGEMGMT-MOB3 Image Service
- SVCSPAREMGMT-MOB3 Advanced Exchange

GOLD Service

Platinum Coverage

- Battery Replacement
- Coverage for Docks/ Chargers
- Sentinel Extended Service for Android Security Updates
- Accidental Damage
- Device Replacement
- Wear & Tear



Battery Chargers



Vehicle Dock



Car Chargers



Battery
(3 Year – 1 replacement battery per RT10)
(5 Year – 2 replacement batteries per RT10)



Docks



Dock Power Supplies

PLATINUM Service

PART NUMBER	DESCRIPTION
SVCRT10-EXW2	RT10, BASIC, 10-15 Day Turnaround, 2 Years (1 Year Factory Warranty + 1 Year Extended)
SVCRT10-SG3N	RT10, Edge Service, GOLD Maintenance Contract, 5 Day Turnaround, 3 Year, New Contract
ADD SVCACC-MOB3	AddOn, Edge Service, Accessory Service , Mobility, 3 Year. Service covers docks, charger cradles, scan handles and car adapter
ADD SVCBATTERY-MOB3	AddOn, Edge Service, Battery Service, Mobility, 3 Year, 1 Replacement Battery over life of contract
ADD SVCREPLACE-MOB3	AddOn, Edge Service, Device Replacement, Mobility, 3 Year
ADD SVCIMAGEMGMT-MOB3	AddOn, Edge Service, Image Service, Mobility, 3 Year
ADD SVCSPAREMGMT-MOB3	AddOn, Edge Service, Advanced Exchange, Mobility, 3 Year. Customer owned spare pool, Minimum Purchase required.
SVCRT10-SP3N	RT10, Edge Service, PLATINUM, 2 Day Turnaround, 3 Year, New Contract

RT10 SOFTWARE

RT10 Client Pack Options

The RT10A (Android) and RT10W (Windows 10) options for Client Pack are listed below.

RT10A - Android



All RT10A units will ship with Device Client Pack pre-licensed which includes first year maintenance and support..

SmartTE is Pre-Loaded, but requires license SMARTTE-001 to be purchased separately.

RT10A - Device Client Pack



PART NUMBER

DCP-SFT1
DCP-SFT3



DESCRIPTION

Device Client Pack - 1 Year Maintenance (Launcher, Enterprise Browser & BasicTE)
Device Client Pack - 3 Year Maintenance (Launcher, Enterprise Browser & BasicTE)

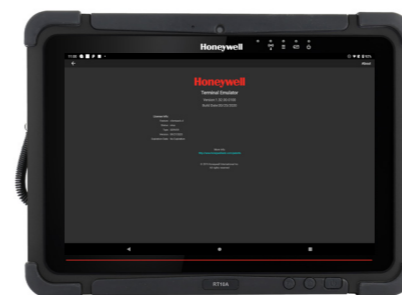

Order Separately



PART NUMBER

SMARTTE-001
SMARTTE-SFT3
SMARTTE-SFT5

DESCRIPTION

SMARTTE - SINGLE PATH W-1 Year Maintenance
SMARTTE - 3 Year Software Maintenance
SMARTTE - 5 Year Software Maintenance

RT10W - Enterprise Client Pack

RT10W - Windows 10



All RT10W units will ship with Enterprise Client Pack pre-licensed which includes first year maintenance.



PART NUMBER

CLIENTPACK-SFT1
CLIENTPACK-SFT3

DESCRIPTION

Software Maintenance - Client Pack - 1 Year Maintenance (Launcher, Enterprise Browser & Windows TE)
Software Maintenance - Client Pack - 3 Year Maintenance (Launcher, Enterprise Browser & Windows TE)



RT10 DESKTOP COMMUNICATIONS

Option 1 – Portable

USB Communication to PC/ Mac OR Snap-On Charging



IEC-C6 Connector

PART NUMBER **DESCRIPTION**

1	RT10-PWR	Spare Power Adaptor. 100-240VAC to 19VDC at 3.42A. Requires Country Specific Power Cord.
2	CBL-500-120-S00-05	USB type A to type C, 1.2 m (3.9 ft)
3	**	AC Power Cord – See Page 34 for Country Specific Power Cords

Option 2 – Fixed – Communications Dock

Ports: 2x USB 2.0 Side, 2x USB 2.0 Rear, RS232, 1x RJ45 Ethernet, VGA.



Rear View



PART NUMBER **DESCRIPTION**

1	RT10-CD	Communications Dock, 12-19V DC Power Supply Included. Requires AC Power Cord.
2	**	AC Power Cord – See Page 34 for Country Specific Power Cords
OPTIONAL	CBL-500-120-S00-05	USB type A to type C, 1.2 m (3.9 ft)

RT10 DESKTOP COMMUNICATIONS

Option 3 – Display Dock

Connect USB peripherals (keyboard, mouse) and External Monitor via HDMI



POWER USB A Ethernet HDMI
Rear View



PART NUMBER	DESCRIPTION
1 RT10-DD	Display Dock for connecting to external monitor. Ports: 1x RJ45 Ethernet, 3x USB-A, 1x HDMI, RT10 pogo-pin dock connector. Kit includes Display Base, Power Supply, must order Power Cord and HDMI cable separately.
2 **	AC Power Cord – See Page 34 for Country Specific Power Cords

RT10 VEHICLE INSTALL

Option 1 - Portable/ Sub Contractor Install

Simple Vehicle Charging, portable between vehicles



PART NUMBER **DESCRIPTION**

1 RT10-MC Vehicle charger / cigarette lighter adapter. 11-32V DC input, 19V / 3.42A DC output.

Option 2 - Portable/ Sub Contractor Install

Ports: 4x USB-A, 1x RS-232, 1x RJ45 Ethernet, 1x GPS antenna



RT10-VD Vehicle Dock I/O Ports
Bottom View



- | Includes:
- | 1 x Terminal Block Plug
- | 1 x Power Cable (Cigarette Receptacle to Terminal Block)
- | 4 x Screws (M4-6mm) for VESA mount



PART NUMBER **DESCRIPTION**

1 RT10-VC Vehicle Cradle - **Power Only**. 3-pin terminal block 9-36V power supply.

OR RT10-VD Vehicle Dock, 3-pin terminal block 9-36V power supply. Easy insert and release with key-lock. Ports: 4x USB-A, 1x RS-232, 1x RJ45 Ethernet, 1x GPS antenna

2 RT10-MNT-RAM 75x75mm VESA Plate with 2.25" diameter rubber ball "D" size.

RT10 VEHICLE INSTALL

Vehicle Dock Options

Choose between Power Only Cradles or Vehicle Dock with I/O Communications.



PART NUMBER **DESCRIPTION**

RT10-VC Vehicle Cradle - **Power Only**. 3-pin terminal block 9-36V power supply. Easy insert and release with key-lock. Ports: 2x USB-A



PART NUMBER **DESCRIPTION**

RT10-VD Vehicle Dock, 3-pin terminal block 9-36V power supply. (RS232 port NOT compatible with Granit, use RT10-EVD) Easy insert and release with key-lock. Ports: 4x USB-A, 1x RS-232, 1x RJ45 Ethernet, 1x GPS antenna

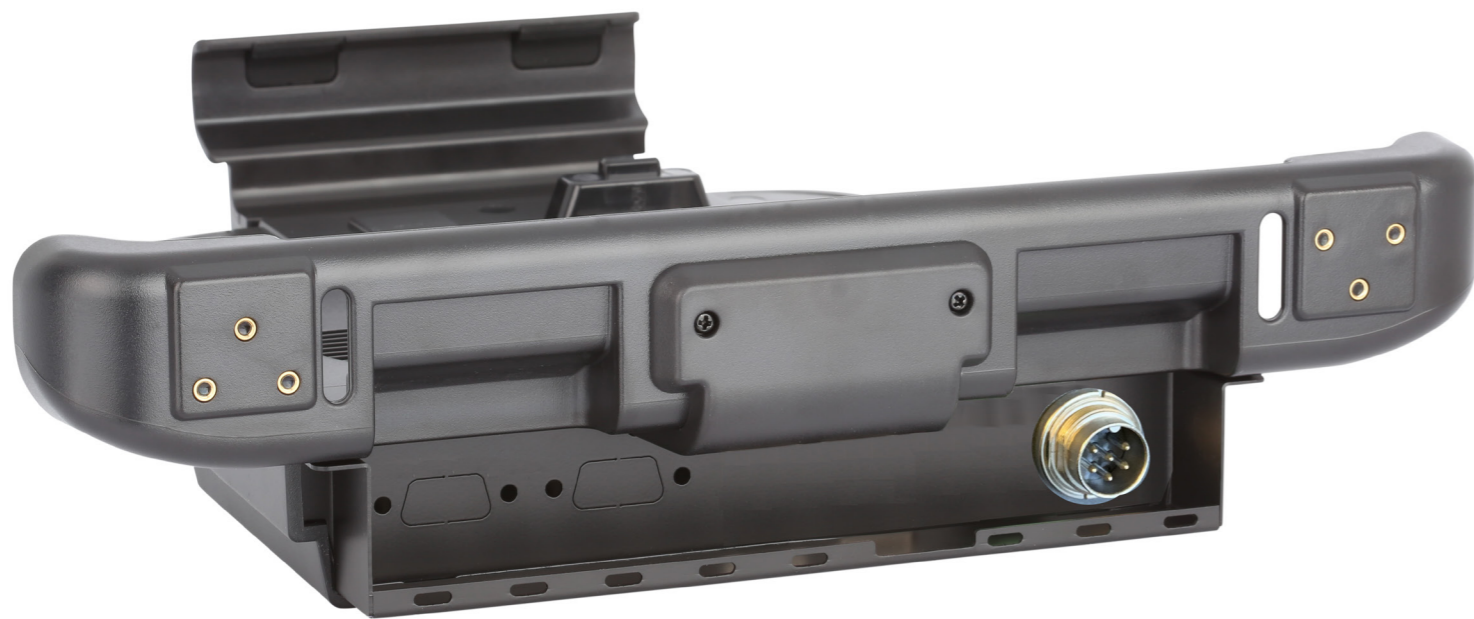

PART NUMBER **DESCRIPTION**

RT10-EVC Enhanced Vehicle Cradle - power only. VM compatible 10-60V power supply. Easy insert and release with key-lock.



PART NUMBER **DESCRIPTION**

RT10-EVD Enhanced Vehicle Dock. VM compatible 10-60V power supply. Easy insert and release with key-lock. Ports: 2x USB-A, 2x RS-232, 1x D-9 USB, RJ45 Ethernet
COM1 RS232 Port provides +5V DC (500mA max) on Pin 9 and is compatible with Granit Scanners

RT10 VEHICLE INSTALL

Vehicle Dock 360 degree view



Side View



Rear View

Recommended Screws
M4 6mm



Angle View

RT10 VEHICLE INSTALL

Vehicle Dock 360 degree view



Rear View

RT10-MNT-RAM 75mm x 75mm (4 holes) Mounting Pattern Overlay



RT10 VEHICLE INSTALL

Power Adapter Cable

3-Pin Terminal Block to VMx Adapter Cable

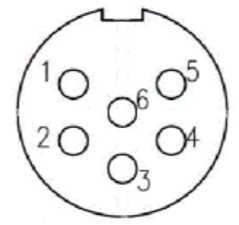
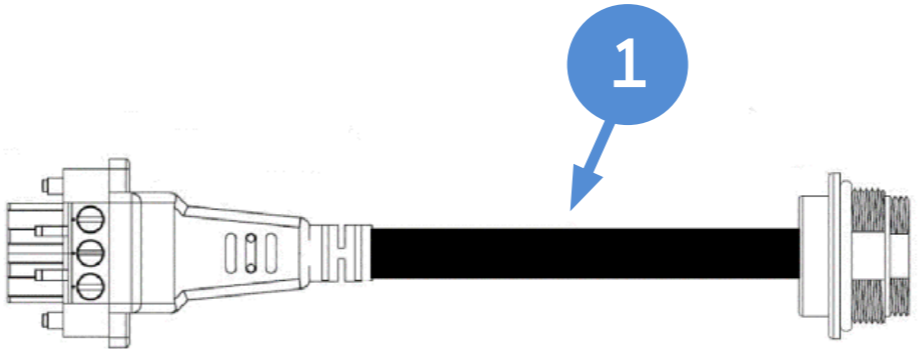

PART NUMBER	DESCRIPTION
1	RT10-VM-POWER-CVRT VM to 3-Pin Power Adapter Cable (Adapt VM1055CABLE to 3-Pin)

RT10 FORKLIFT INSTALL

Option 1 - WWAN - Keyboard - Tethered Scanner



PART NUMBER DESCRIPTION

1	RT10A-L1N-18C11SOx	RT10 WWAN / FlexRange / Device Client Pack
2	RT10-EVD	Enhanced Vehicle Dock, 10 to 60 VDC (Requires VM1055CABLE)
3A	RT10-2012BRKTKIT	RAM mount kit, keyboard, Round Base, Medium arm 8.5inch (215 mm)
4	9000160KEYBRD	Windows Laptop Style 95 key rugged keyboard with integrated 2 button mouse, DB9M USB Interface
5	VM1055CABLE	VM1, VM2, VM3 DC power cable right angle (spare)
6	1980iFR-3SER	1980iFR-3: 1D/2D, FR focus (EX20), red scanner (1980iFR-3), RS232
OPTIONAL	7	TOOLBAL Scanner take up reel/balancer
OPTIONAL	8	VMHOLDER3K Vehicle Mount Kit

SERVICE

SVCRT10-SG3N	RT10, Edge Service, GOLD Maintenance Contract, 5 Day Turnaround, 3 Year, New Contract
SVCACC-MOB3	AddOn, Edge Service, Accessory Service, Mobility, 3 Year.
3B	RT10-2015BRKTKIT RAM mount kit, keyboard, Clamp Base, Medium arm 8.5inch (215 mm)
SVC1980i-SG3N	Granit, Edge Service, GOLD, 1 Day, 3 Year, New Contract

RT10 FORKLIFT INSTALL

Option 2 - WWAN - Keyboard - Bluetooth Scanner



PART NUMBER DESCRIPTION

1	RT10A-L1N-18C11SOx	RT10 WWAN / FlexRange / Device Client Pack
2	RT10-EVD	Enhanced Vehicle Dock, 10 to 60 VDC (Requires VM1055CABLE)
3A	RT10-2012BRKTKIT	RAM mount kit, keyboard, Round Base, Medium arm 8.5inch (215 mm)
4	9000160KEYBRD	Windows Laptop Style 95 key rugged keyboard with integrated 2 button mouse, DB9M USB Interface
5	VM1055CABLE	VM1, VM2, VM3 DC power cable right angle (spare)
6	1981IFR-3	Scanner, 1D/2D, FR focus (EX20), red, Bluetooth Class 1, with vibrator**
OPTIONAL	7	TOOLBAL Scanner take up reel/balancer
OPTIONAL	8	VMHOLDER3K Vehicle Mount Kit

SERVICE

SVCRT10-SG3N	RT10, Edge Service, GOLD Maintenance Contract, 5 Day Turnaround, 3 Year, New Contract
SVCACC-MOB3	AddOn, Edge Service, Accessory Service, Mobility, 3 Year.
3B RT10-2015BRKTKIT	RAM mount kit, keyboard, Clamp Base, Medium arm 8.5inch (215 mm)
SVC1981i-SG3N	Granit, Edge Service, GOLD, 1 Day, 3 Year, New Contract

RT10 FORKLIFT INSTALL

Option 3 - WWAN - Tethered Scanner



PART NUMBER DESCRIPTION

1	RT10A-L1N-18C11SOx	RT10 WWAN / FlexRange / Device Client Pack
2	RT10-EVD	Enhanced Vehicle Dock, 10 to 60 VDC (Requires VM1055CABLE)
3A	RT10-MNT-RAM	75x75mm VESA Plate with 2.25" diameter rubber ball "D" size.
	VX89A030RAMBALL	Ball, "D"-size 2.25in., Round Base 3.68in. base, typically mounts to vehicle.
	VX89A501RAMARM	RAM medium arm, 8.5in. (215mm) for "D"-size 2.25in. balls.
4	VM1055CABLE	VM1, VM2, VM3 DC power cable right angle (spare)
5	1980IFR-3SER	1980iFR-3: 1D/2D, FR focus (EX20), red scanner (1980iFR-3), RS232
OPTIONAL 6	TOOLBAL	Scanner take up reel/balancer
OPTIONAL 7	VMHOLDER3K	Vehicle Mount Kit

SERVICE

SVCRT10-SG3N	RT10, Edge Service, GOLD Maintenance Contract, 5 Day Turnaround, 3 Year, New Contract
SVCACC-MOB3	AddOn, Edge Service, Accessory Service, Mobility, 3 Year.
3B	RT10-MNT-RAM
	VX89A031RAMBALL
	VX89A501RAMARM
SVC1980i-SG3N	Granit, Edge Service, GOLD, 1 Day, 3 Year, New Contract

RT10 FORKLIFT INSTALL

Option 4 - WWAN - Bluetooth Scanner

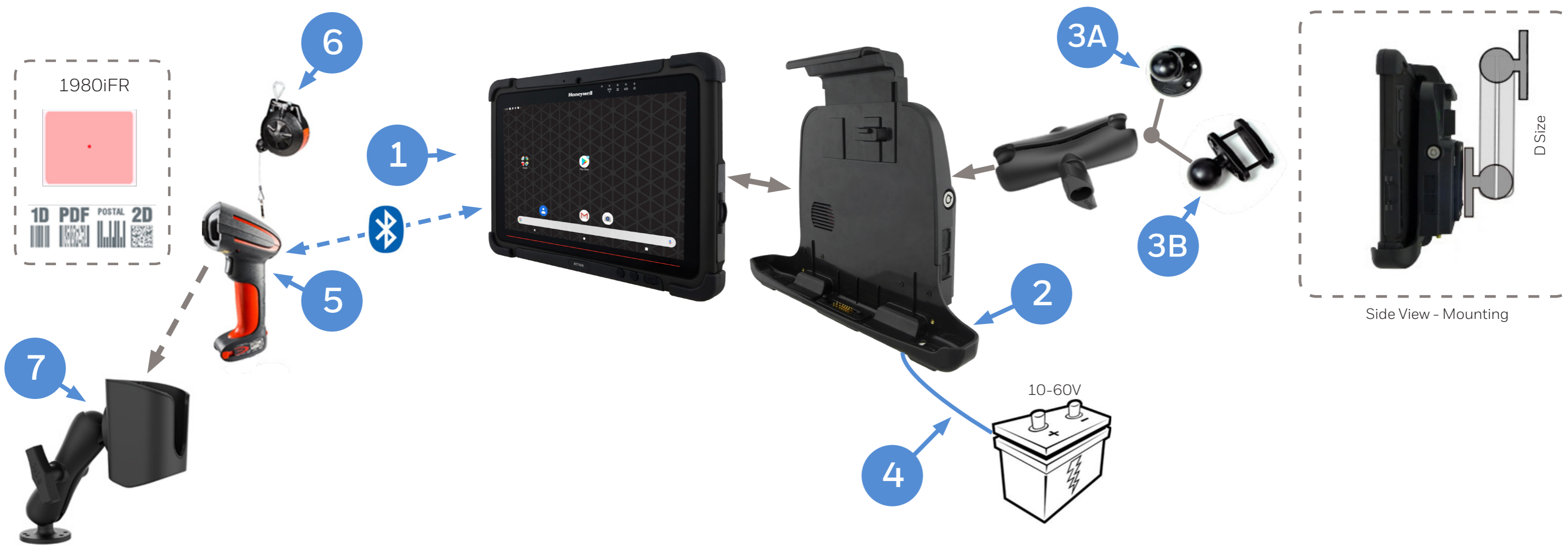

PART NUMBER DESCRIPTION

1	RT10A-L1N-18C11SOx	RT10 WWAN / FlexRange / Device Client Pack
2	RT10-EVD	Enhanced Vehicle Dock, 10 to 60 VDC (Requires VM1055CABLE)
3A	RT10-MNT-RAM	75x75mm VESA Plate with 2.25" diameter rubber ball "D" size.
	VX89A030RAMBALL	Ball, "D"-size 2.25in., Round Base 3.68 in.W typically mounts to vehicle.
	VX89A501RAMARM	RAM medium arm, 8.5in. (215mm) for "D"-size 2.25in. balls.
4	VM1055CABLE	VM1, VM2, VM3 DC power cable right angle (spare)
5	1981IFR-3	Scanner, 1D/2D, FR focus (EX20), red, Bluetooth Class 1, with vibrator**
OPTIONAL	6	TOOLBAL Scanner take up reel/balancer
OPTIONAL	7	VMHOLDER3K Vehicle Mount Kit

SERVICE

SVCRT10-SG3N	RT10, Edge Service, GOLD Maintenance Contract, 5 Day Turnaround, 3 Year, New Contract
SVCACC-MOB3	AddOn, Edge Service, Accessory Service, Mobility, 3 Year.
3B	RT10-MNT-RAM 75x75mm VESA Plate with 2.25" diameter rubber ball "D" size.
	VX89A031RAMBALL Ball, "D"-size 2.25in., Flat 2.5in. Clamp Base , typically mounts to vehicle.
	VX89A501RAMARM RAM medium arm, 8.5in. (215mm) for "D"-size 2.25in. balls.
SVC1981i-SG3N	Granit, Edge Service, GOLD, 1 Day, 3 Year, New Contract

RT10 PORTS

RT10W and RT10A I/O Ports



RT10W



RT10A



- 1x Micro HDMI
- 1x Micro SDXC slot
- 1x USB 3.0 (Type C)
- 1x USB 3.0 (Type A)
- 1x 3.5mm Audio Combo Connector (Mic in or line out)
- 1x DC jack



- 1x Micro SDXC slot
- 1x USB 3.0 (Type C)
- 1x USB 3.0 (Type A)
- 1x 3.5mm Audio Combo Connector (Mic in or line out)
- 1x DC jack

RT10 BATTERY PACK

Standard or Extended Battery

Select the battery pack to suit the deployment.

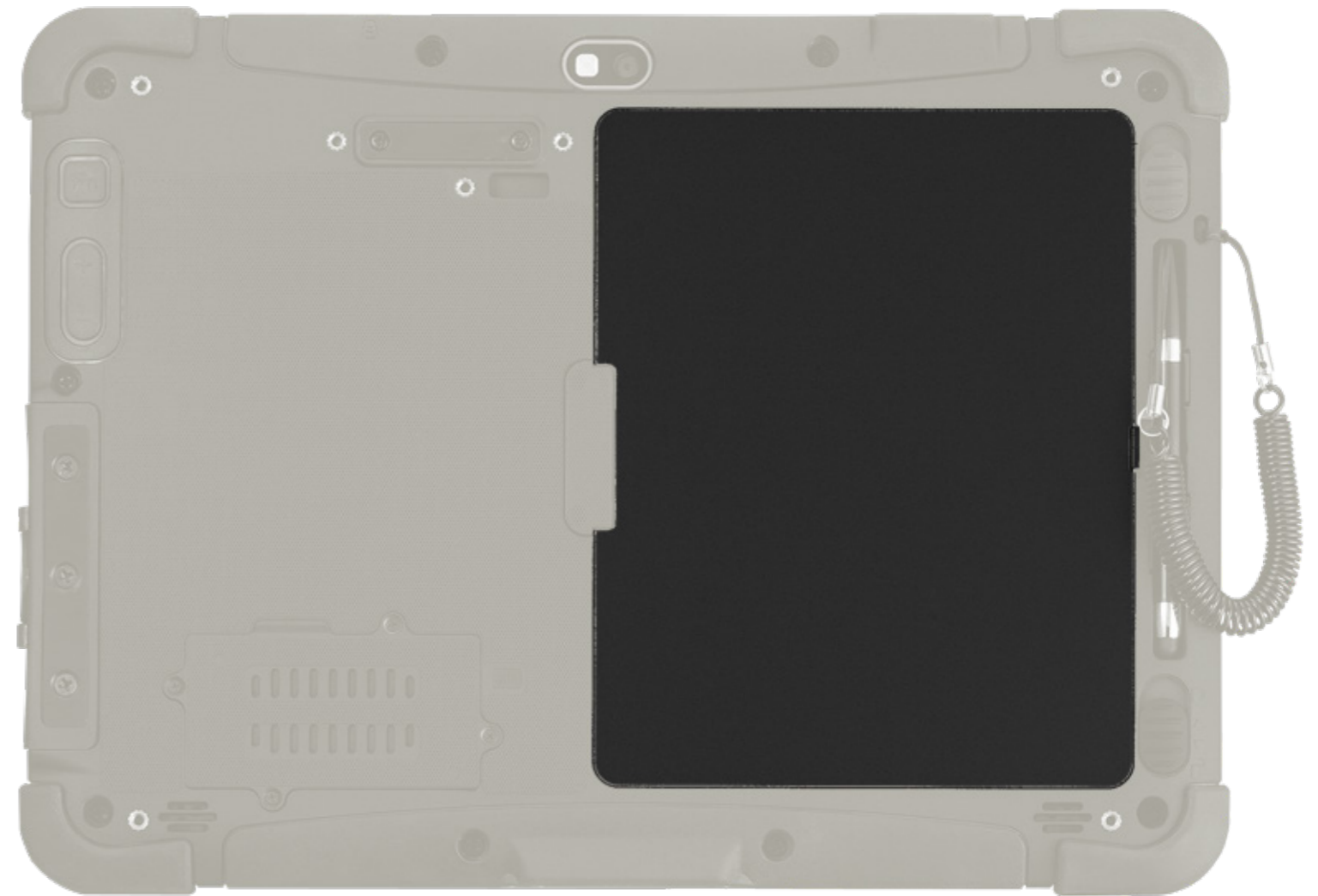

Rear View
RT10 Battery Location

PART NUMBER	DESCRIPTION
1	RT10-BAT-STD1 Spare Standard Battery. 7.4V 5,900 mAh Li-Polymer Battery, 276g weight, 11mm thickness.
2	RT10-BAT-EXT1 Spare Extended Battery. 7.4V 10,280 mAh Li-Polymer Battery, 474g weight, 16.5mm thickness.

RT10 BATTERY CHARGER

2 Bay Battery Charging

Supports Batteries: RT10-BAT-STD1 Spare Standard Battery. 7.4V 5,900 mA
 RT10-BAT-EXT1 Spare Extended Battery. 7.4V 10,280 mAh



Batteries inserted in charger

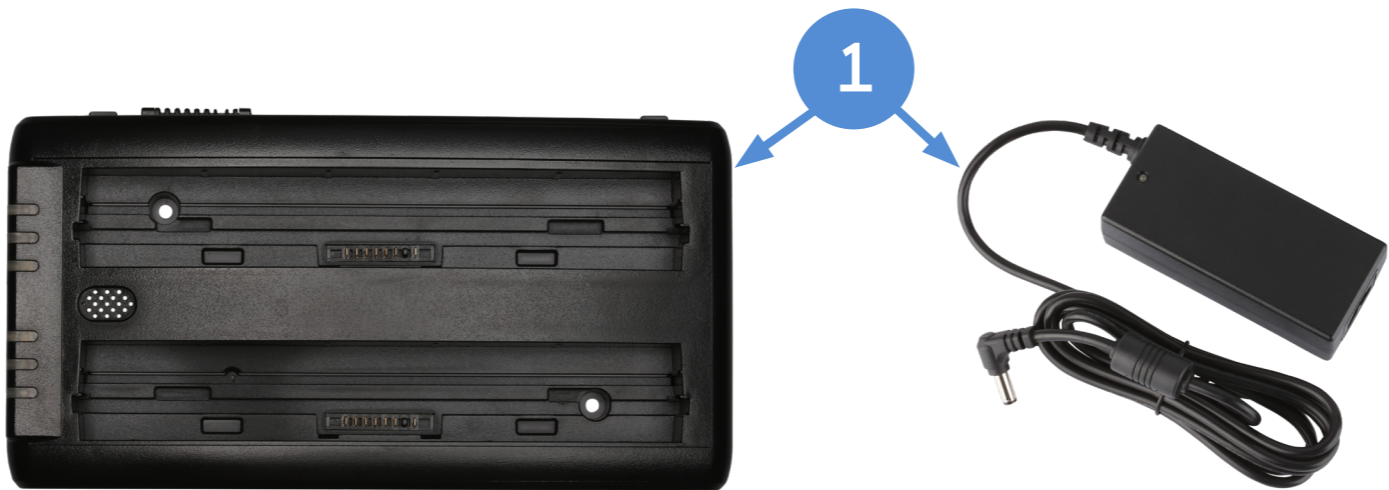

	PART NUMBER	DESCRIPTION
1	RT10-BC-2	2-bay battery charger for standard or extended batteries. 12-19V DC in power. Standard battery charges in 3hrs, Extended battery charges in 6hrs. Kit includes: 1 x 2-bay battery charger, 1 x 19V AC adapter. Requires country specific cord.
	**	AC Power Cord – See Page 34 for Country Specific Power Cords

RT10 ACCESSORIES

Smart Card Reader

Smart Card Reader Attachment.



PART NUMBER

DESCRIPTION

1

RT10-CAC

Smart card reader. Snaps onto the back of the tablet.

RT10 VESA MOUNT

Stationary Mounting

VESA Mount for permanent mounting of the RT10, used in combination with power supply as the plate restricts access to the battery.

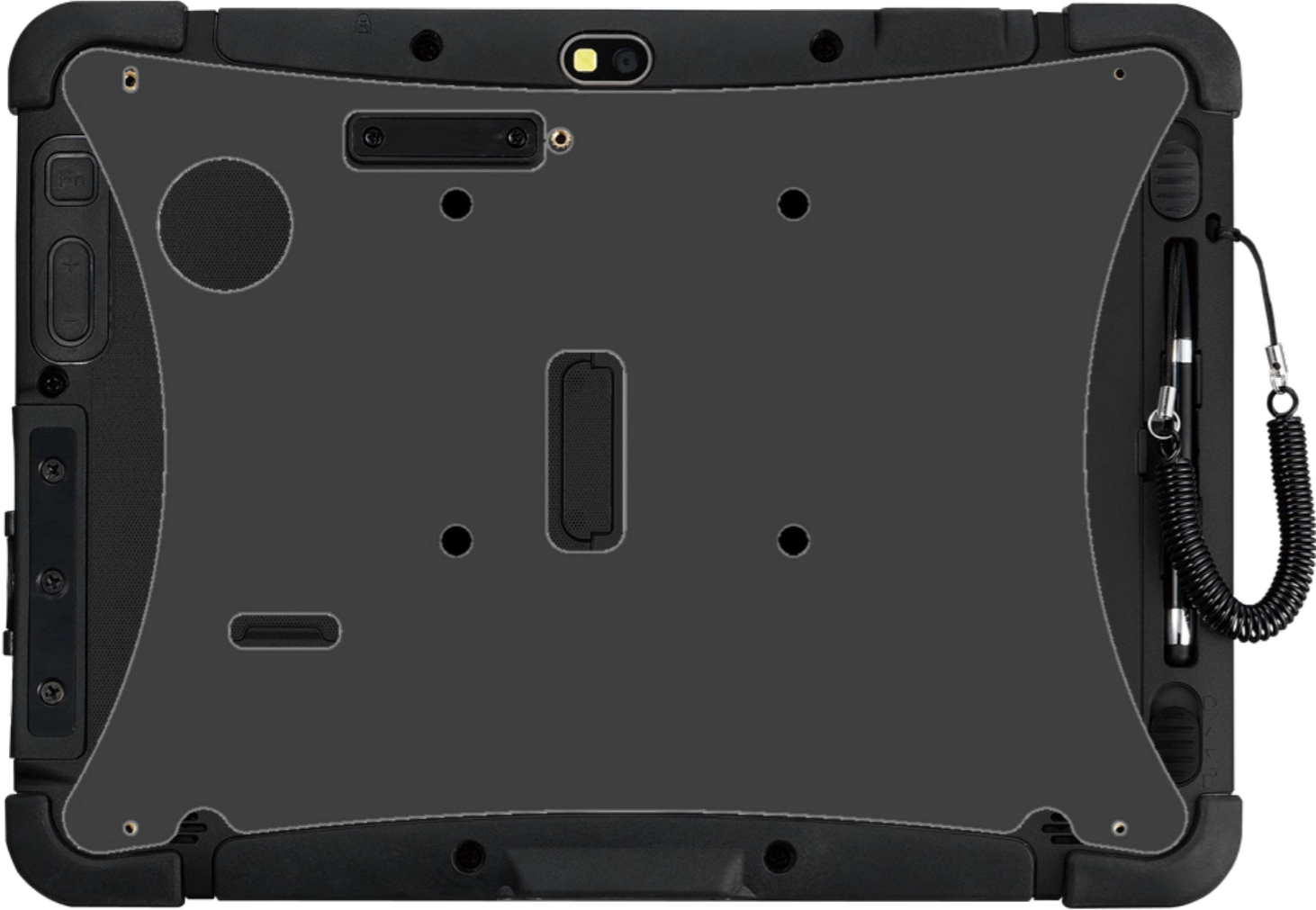

PART NUMBER	DESCRIPTION
1	RT10-MNT-VS 75x75mm VESA mount kit. SGCC grade steel. Includes 5x M4 6mm round screws, 5x M3 5mm round screws.

GRANIT SCANNER OPTIONS

Granit 1981i Bluetooth Accessories

1981i Bluetooth Spare Battery/ Charging



PART NUMBER **DESCRIPTION**

BAT-SCN01A Battery: Lithium-ion battery for Voyager 1202, 1452g, Xenon 1902, Granit 1911i, Granit 1981i, 3820 and 3820i cordless scanners (3.75V 2400mAh 9Wh)



PART NUMBER **DESCRIPTION**

HOLSTER-INDUSTRIAL When clipped to a user's belt holster enables storage of Granit 1911i and 1981i cordless imagers while leaving hands-free to accomplish other tasks (scanner sold separately)



PART NUMBER **DESCRIPTION**

MB4-BAT-SCN01NAWO Charger: 4-bay battery charger (NA) for use with Voyager 1202g, 1452g, Xenon 1902, Granit 1911i, Granit 1981i, 3820, 3820i, Lithium-ion batteries, NA wallmount power supply (PS-050-4000W-NA), two mounting screws (100006897), and Instructions (MBC-INST)



PART NUMBER **DESCRIPTION**

50110266-001FRE END CAP, CORDLESS, 1911i & 1981i



PART NUMBER **DESCRIPTION**

COB02 Charge-Only Base: only 1 scanner can be charged at a time, power supply must be purchased separately. Select appropriate regional Power Supply PS-05-1000W-x

PS-05-1000W-A Power Supply: North America plug, 1.0A @ 5.2 VDC 90-255VAC @ 50-60Hz

PS-05-1000W-C Power Supply: EU plug, 1.0A @ 5.2VDC 90-255VAC @ 50-60Hz

PS-05-1000W-U Power Supply: UK plug, 1.0A @ 5.2VDC 90-255VAC @ 50-60Hz

PS-05-1000W-I Power Supply: Australia, New Zealand plug, 1.0A @ 5.2 VDC 90-255VAC @ 50-60Hz

GRANIT SCANNER OPTIONS

Granit 1980i - Serial Cable Types

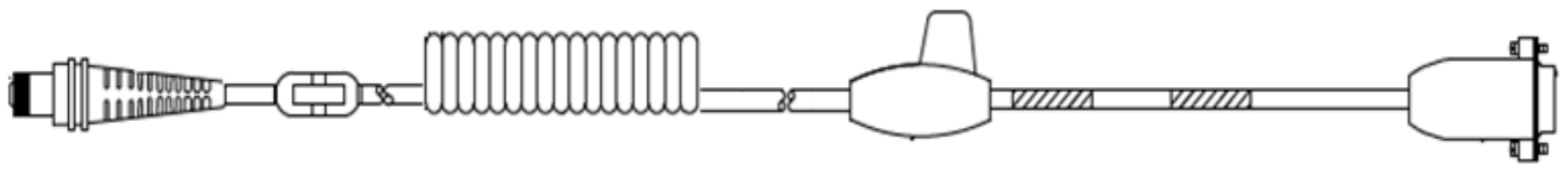
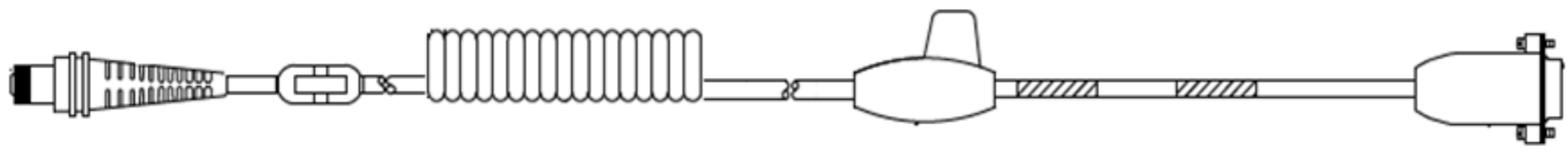
SERIAL					
CBL-020-300-C00-01	Cable - Industrial: RS232 (5V signals), black, DB9 Female, 3m (9.8'), coiled, 5V external power with option for host power on pin 9	3m	COILED		
					
CBL-020-500-C00-01	Cable - Industrial: RS232 (5V signals), black, DB9 Female, 5m (16.4'), coiled, 5V external power with option for host power on pin 9	5m	COILED		
					

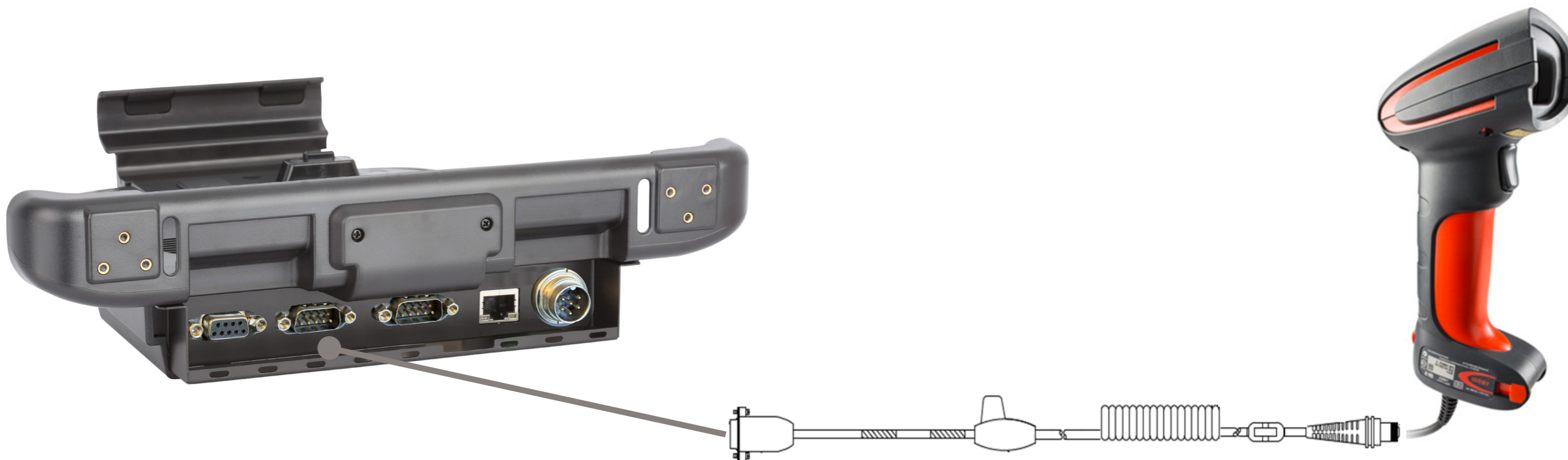

GRANIT SCANNER OPTIONS

Granit 1980i - USB Cable Types

USB				
CBL-501-300-S00	CABLE, USB,9PIN DB9 MALE 5V, INDUSTRIAL	3m	STRAIGHT	Connect direct to the Smart Dock to DB9F USB/USB1 Port



Note: This cable only supports USB Keyboard (PC) interface.

MISCELLANEOUS

Hand Strap

Adjustable buckle for changing battery easily.

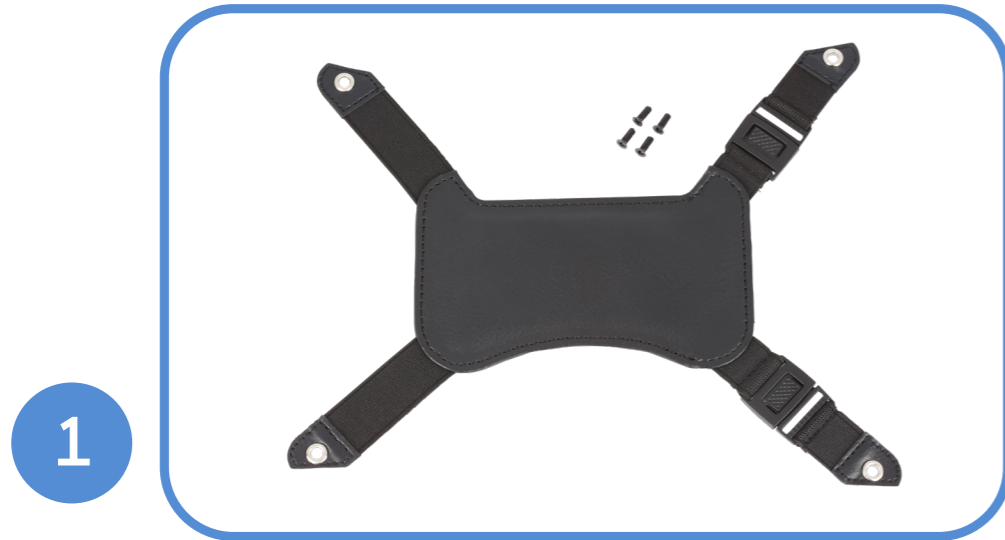

1



PART NUMBER **DESCRIPTION**

1 RT10-HS-1 Hand strap kit including screws. Adjustable for Standard or Extended battery sizes.

Shoulder Strap

Strap length adjustable (85cm ~ 165cm).



1



PART NUMBER **DESCRIPTION**

1 RT10-SS-1 Shoulder strap kit including screws. Adjustable cross body strap with pad.

MISCELLANEOUS

Stylus



1

PART NUMBER	DESCRIPTION
1 RT10-STY-1	Replacement capacitive stylus with tether.

Carry Bag



1

PART NUMBER	DESCRIPTION
1 RT10-CASE	Carry bag with hand carrier and adjustable shoulder strap. Separated pocket for accessories.

MISCELLANEOUS

Optional Parts

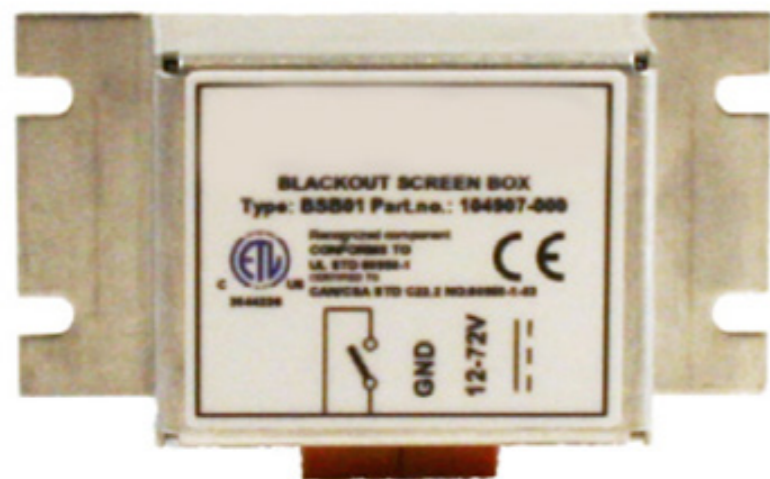

PART NUMBER	DESCRIPTION
VX89351PWRSPLY	Screen Blanking Switch Box Requires VM1080CABLE



PART NUMBER	DESCRIPTION
VM1080CABLE	Screen Blanking Box Cable VM1 screen blanking box cable D9F to bare wires, 6ft. (1.8m).



PART NUMBER	DESCRIPTION
RT10-SCREEN-FILM1	RT10 Screen Protectors (Pack of 1)



PART NUMBER	DESCRIPTION
RT10-KEYBD-PLATE	RT10 keyboard plate adapter (C-Size RAM mount or keyboard are not included)



PART NUMBER	DESCRIPTION
RT10-MNT-RAM	75x75mm VESA Plate with 2.25" diameter rubber ball "D" size.

MISCELLANEOUS

Micro-SD Cards

Honeywell Recommended – ATP Industrial Grade Micro SD Cards



Why ATP Industrial Grade SD?

ATP's SIP (System-In-Packaging) manufacturing process encapsulates all exposed components and points of failure to ensure the products are fully waterproof, shockproof, and ESD (Electro-Static Discharge) proof. ATP Industrial Grade SD/SDHC Cards can withstand at least an operating/storage temperature range of at least -40 to 85 degrees Celsius. In addition to this temperature range, the cards are completely waterproof, dustproof, and ESD (Electro-Static Discharge) proof. All ATP Industrial Grade SD/SDHC cards are produced under a stringent RoHs and Green Package compliant manufacturing process to guarantee a consistent high level of build quality and performance. ATP Industrial SD cards deliver outstanding performance with read speed (seq) up to 18MB/sec and write speed (seq) up to 16MB/sec. All ATP Industrial Grade CF, SD, USB drives, and SSDs are constructed using best-in-class SLC(Single-Level Cell) components with enhanced Error Correction Code(ECC) functions and wear levelling algorithms. This results in MTBF ratings over 2 million hours and the highest write cycle lifetimes in the industry.

	PART NUMBER	DESCRIPTION
1	856-065-004	MICRO-SD CARD, 1GB , AFIGUDI, ROHS
OR	856-065-005	MICRO-SD CARD, 2GB , AFIGUDI, ROHS
OR	856-065-006	MICRO-SD CARD, 4GB , AFIGUDI, ROHS
OR	856-065-007	MICRO-SD CARD, 8GB , AFIGUDI, ROHS

AC Cords

Regional Power Cords



AC Power - C6 Type Connector

PART NUMBER	DESCRIPTION
RT10-PWR-CABLE-US	C6 type power cable, USA
RT10-PWR-CABLE-EU	C6 type power cable, Europe
RT10-PWR-CABLE-DMK	C6 type power cable, Denmark 3-pin
RT10-PWR-CABLE-ITAL	C6 type power cable, Italy 3-pin
RT10-PWR-CABLE-SWIZ	C6 type power cable, Switzerland 3-pin
RT10-PWR-CABLE-UK	C6 type power cable, UK 3-blade
RT10-PWR-CABLE-AUS	C6 type power cable, Australia

MISCELLANEOUS

Disclaimer

Honeywell International Inc. (“HII”) reserves the right to make changes in specification and other information contained in this document without prior notice, and the reader should in all cases consult HII to determine whether any such changes have been made. The information in this publication does not represent a commitment on the part of HII.

HII shall not be liable for technical or editorial errors or omissions contained herein; nor for incidental or consequential damages resulting the furnishing, performance, or use of this material.

This document contains proprietary information that is protected by copyright. All rights are reserved. No part of this document may be photocopied, reproduced, or translated into another language with-out prior written consent of HII.

Web Address: www.honeywellaidc.com

The Bluetooth trademarks are owned by Bluetooth SIG, Inc., U.S.A and licensed to Honeywell.

Thor and Mobility Edge are trademarks or registered trademarks of Honeywell International Inc. in the United States and/or other countries.

Android is a trademark or registered trademark of Google Inc. in the United States and/or other countries. Windows is a trademark or registered trademark of Microsoft Corporation.

Qualcomm and Snapdragon are trademarks or registered trademarks of Qualcomm Incorporated in the United States and/or other countries.

Intel and Pentium are trademarks or registered trademarks of Intel Corporation.

Other product names mentioned in the manual may be trademarks of registered trademarks of their respective companies and are the property of their respective owners.

All rights reserved.

For more information

www.honeywellaidc.com

Honeywell Safety and Productivity Solutions

9680 Old Bailes Road

Fort Mill, SC 29707

800-582-4263

www.honeywell.com