

DCS-8635LH

2K QHD Pan & Zoom Outdoor Wi-Fi Camera

D-Link[®]



User Manual



07/01/2021

Hardware: A1
Manual Version: 1.01

Manual Overview

D-Link reserves the right to revise this publication and to make changes in the content hereof without obligation to notify any person or organization of such revisions or changes. Information in this document may become obsolete as our services and websites develop and change. Please refer to the www.mydlink.com website for the most current information.

Manual Revisions

| Revision | Date | Description |
|----------|------------|-----------------|
| 1.00 | 04/09/2021 | Initial release |

Trademarks

D-Link and the D-Link logo are trademarks or registered trademarks of D-Link Corporation or its subsidiaries in the United States or other countries. All other company or product names mentioned herein are trademarks or registered trademarks of their respective companies.

Copyright © 2021 by D-Link Corporation, Inc.

All rights reserved. This publication may not be reproduced, in whole or in part, without prior expressed written permission from D-Link Corporation, Inc.

Table of Contents

| | |
|---|-----------|
| Product Overview | 1 |
| Package Contents..... | 1 |
| Introduction | 2 |
| System Requirements..... | 2 |
| Hardware Overview..... | 3 |
| Front..... | 3 |
| Bottom..... | 4 |
| LED Behavior | 5 |
| Installation | 6 |
| Safety | 6 |
| Before You Begin..... | 6 |
| Wireless Installation Considerations..... | 7 |
| mydlink App Camera Setup..... | 8 |
| Device Placement..... | 10 |
| Mounting the Camera..... | 11 |
| Pole Mounting | 11 |
| Wall/ Ceiling Mounting..... | 12 |
| Using the mydlink App | 14 |
| Controlling Your Device | 14 |
| Device Settings..... | 16 |
| Troubleshooting | 18 |
| Technical Specifications | 19 |
| Regulatory Information | 21 |

Product Overview

Package Contents



2K QHD Pan & Zoom Outdoor Wi-Fi Camera

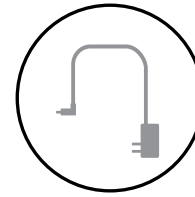

Power Adapter

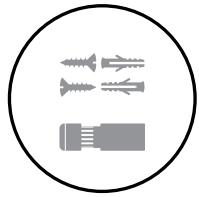

Accessories

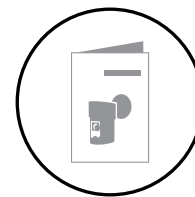

Quick Installation Guide

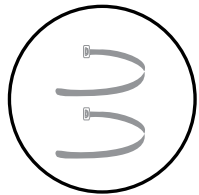

Cable Ties

If any of the above items are missing, please contact your reseller.

Note: Using a power supply with a different voltage rating than the one included with your product will cause damage and void the warranty for this product.

Introduction

No more struggles to find the perfect angle, the DCS-8635LH lets you adjust your camera a full 270-degrees. With vivid QHD 1440p resolution @ 25fps per second, you'll never miss a moment, and what's more – built-in AI-based Person Detection cleverly identifies human motion, so you only get alerts when it matters most. Enhanced sound and motion detection help with the heavy lifting and with built-in Bluetooth Low Energy (BLE) technology - it's one of our easiest cameras to set up yet!

System Requirements

| | |
|----------------------------------|---|
| Network Requirements | <ul style="list-style-type: none">• 10/100 Ethernet network or 802.11n/ac wireless network• An Internet connection• A router connected to your broadband modem |
| mydlink™ App Requirements | <ul style="list-style-type: none">• iOS or Android device (please refer to the mobile app's store page to check whether your device is compatible)• Email account (for mydlink service registration) |

Hardware Overview

Front



| | |
|---------------------|---|
| Status LED | See LED Behavior on page 5 for more information. |
| Microphone | Picks up sound near your camera. |
| Light Sensor | The IR-Cut removable sensor monitors lighting conditions and switches between color and infrared accordingly. |
| Camera Lens | Records video of the surrounding area. |



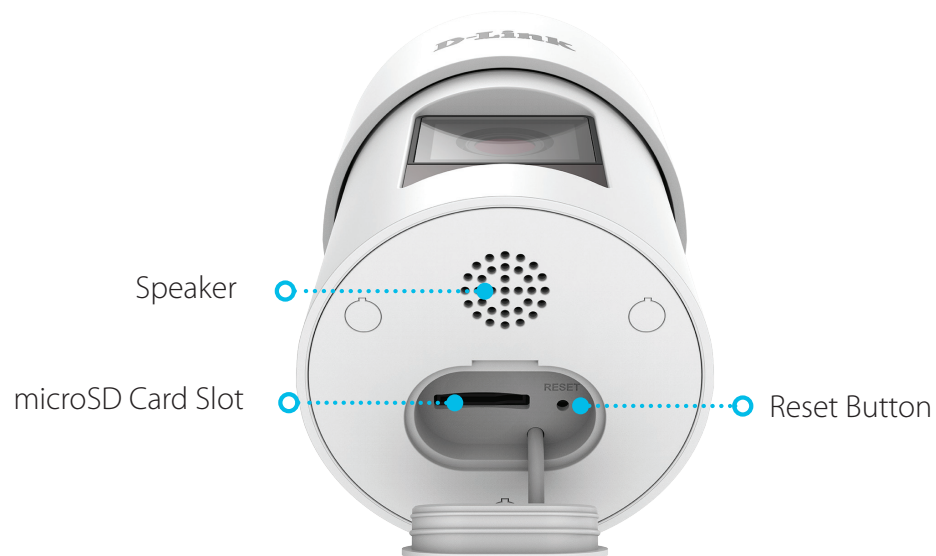

Bottom



| | |
|--------------------------|--|
| Speaker | Provides audio playback for the two-way audio feature. |
| microSD Card Slot | microSD card slot, supports up to 256 GB. |
| Reset Button | Hold the recessed button down to reset the camera to factory default settings. |

LED Behavior



| | | |
|-------------------|---|---|
| Status LED |  | Connected to the network and mydlink. |
| |  | Booting up. |
| |  | Ready for set up. |
| |  | Firmware being updated - do not power off. |
| |  | Timeout for setup - please power cycle the device |

Installation Safety

Please read all of the safety and operating instructions before using device:

- Do not open the device or attempt to repair it.
- Do not submerge the device in liquid or attempt to clean it with liquids or solvents. To clean the device, disconnect it from the power outlet and use a damp towel to gently wipe it down.

Before You Begin

Plan the location of your camera:

- Verify that your camera is electrically rated to operate with the power available in your location.
- Connect the camera's power adapter into an electrical outlet that is not controlled by a wall switch. This will help avoid accidentally turning off power to the device.
- Be sure to plug the device into a properly grounded electrical outlet in order to help prevent against electrical shock.
- Make sure that the device is firmly mounted.

Wireless Installation Considerations

The DCS-8635LH 2K QHD Pan & Zoom Outdoor Wi-Fi Camera lets you view video footage from virtually anywhere within the operating range of your wireless network. Keep in mind that the number, thickness and location of walls, ceilings, or other objects that the wireless signals must pass through may limit the range. Typical ranges vary depending on the types of materials and background RF (radio frequency) noise in your home or business. The key to maximizing wireless range is to follow these basic guidelines:

1. Keep the number of walls and ceilings between the camera and wireless access point to a minimum - each wall or ceiling can reduce your camera's range from 1 to 30 meters (3 to 90 feet). Position your devices so that the number of walls or ceilings is minimized.
2. Be aware of the direct line between network devices. A wall that is 0.5 meters (1.5 feet) thick, at a 45-degree angle appears to be almost 1 meter (3 feet) thick. At a 2-degree angle it looks over 14 meters (42 feet) thick! Position devices so that the signal will travel straight through a wall or ceiling (instead of at an angle) for better reception.
3. Building materials make a difference. A solid metal door or aluminum studs may have a negative effect on range. Try to position access points, wireless routers, and cameras so that the signal passes through drywall or open doorways. Materials and objects such as glass, steel, metal, walls with insulation, water (fish tanks), mirrors, file cabinets, brick, and concrete will degrade your wireless signal.
4. Keep your product away at least 1 to 2 meters (3 to 6 feet) from electrical devices or appliances that generate RF noise.

mydlink App Camera Setup

- 1/ Download the mydlink app from the App Store (iOS) or Google Play (Android) by scanning the QR code.

Note: Ensure that your device is wirelessly connected to the network that the DCS-8635LH will be in.



- 2/ Launch the mydlink app and create a new account or sign in to your existing account.

Note: If you are asked about allowing the app to access your location or to send notifications, select **Allow**. Make sure location services and Bluetooth are turned on in your phone's settings.



3/ Power on the device and wait for the Status LED to flash orange.

Note: Make sure that your mobile device's Bluetooth is on.



4/ Place your device next to your mobile device. A prompt will appear - tap **Add Device**, then follow the app instructions.

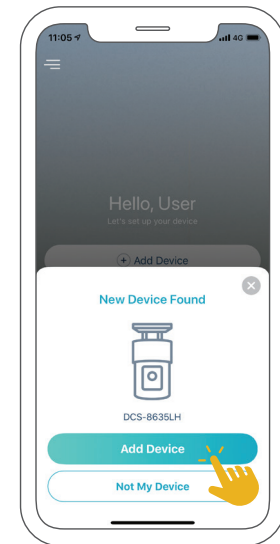

Device Placement

To get the most out of your camera's view and features, please take the following placement guidelines into consideration.

Height: Install the camera 2 to 2.5 meters (6.5 to 8 feet) from the ground. Higher or lower installation points will greatly decrease person detection accuracy.

Person Detection: Person detection works properly when the subject is between 2 to 7 meters (6.5 to 23 feet) away from the camera. Detection accuracy decreases outside of this range.

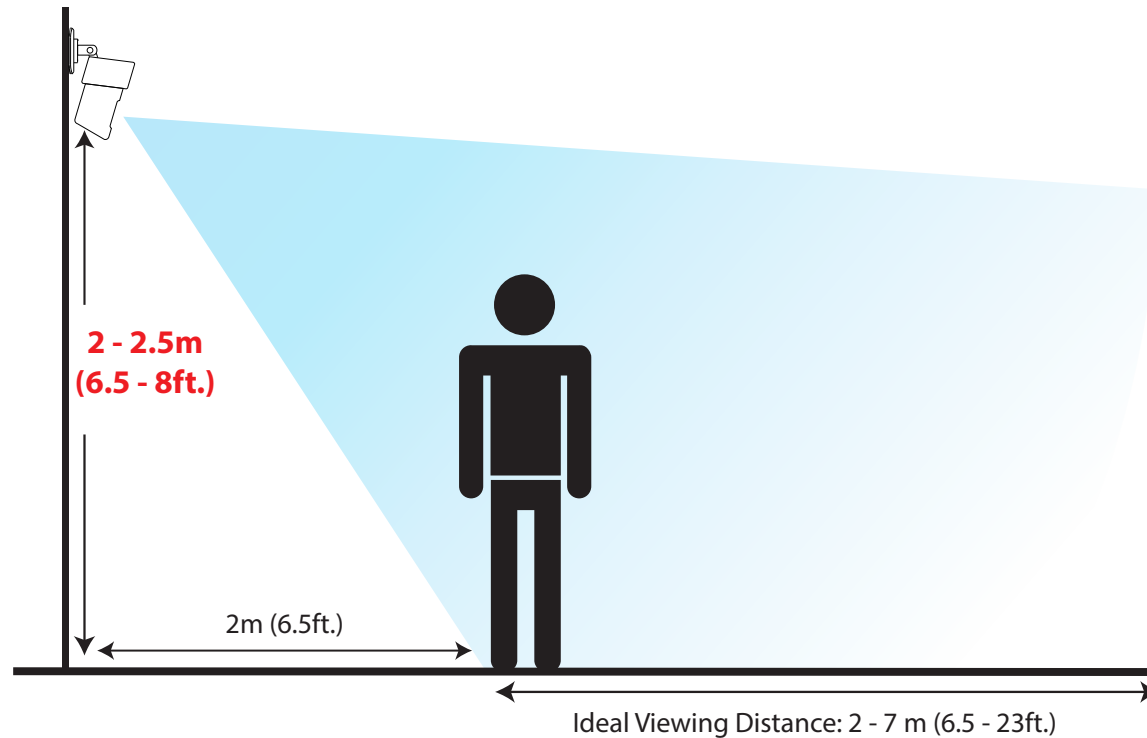

Mounting the Camera Pole Mounting

- 1/ Place the base plate against the pole and make sure the arrow  is pointing upwards.

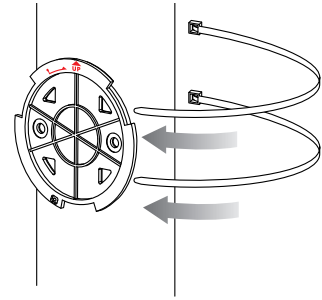

- 2/ Thread the cable ties through the slots on the base plate. Make sure the textured side of the cable ties is facing the pole to avoid slippage. Then fasten the plastic ties around the pole to secure the base plate.

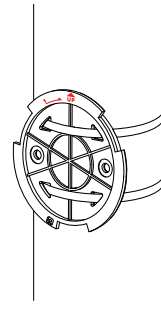

- 3/ Align the arrow on the camera base with the dot on the base plate and turn clockwise to secure them together.

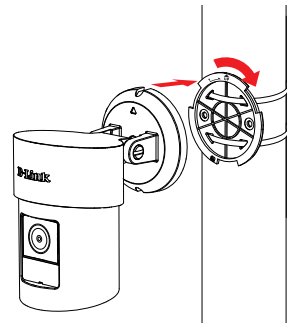

Wall/ Ceiling Mounting

The device can be mounted on a wall or on the ceiling.

- 1/ Stick the alignment sticker on the location where you want to mount the camera, and **ensure the holes are level**. Then use a 6 mm drill bit to drill two 26 mm deep holes.

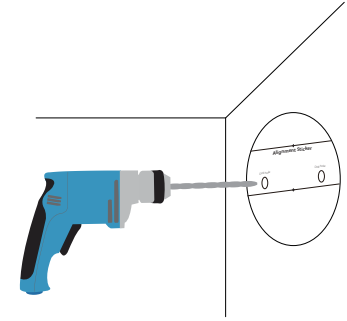

- 2/ Hammer in the plastic wall anchors to support the screws.

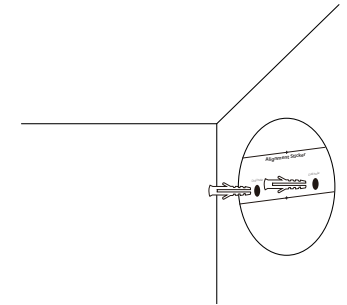

- 3/ Align the base plate over the holes and secure it tightly with screws.

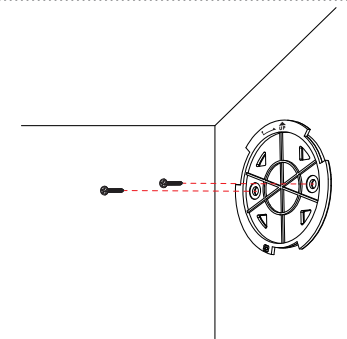

- 4/ Align the arrow on the camera base with the dot on the base plate and turn clockwise to secure them together.

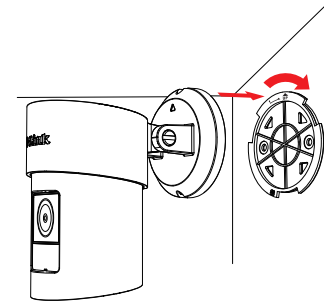

- 5/ Adjust the camera to your desired position.

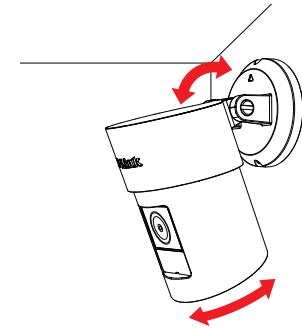













Using the mydlink App

Controlling Your Device







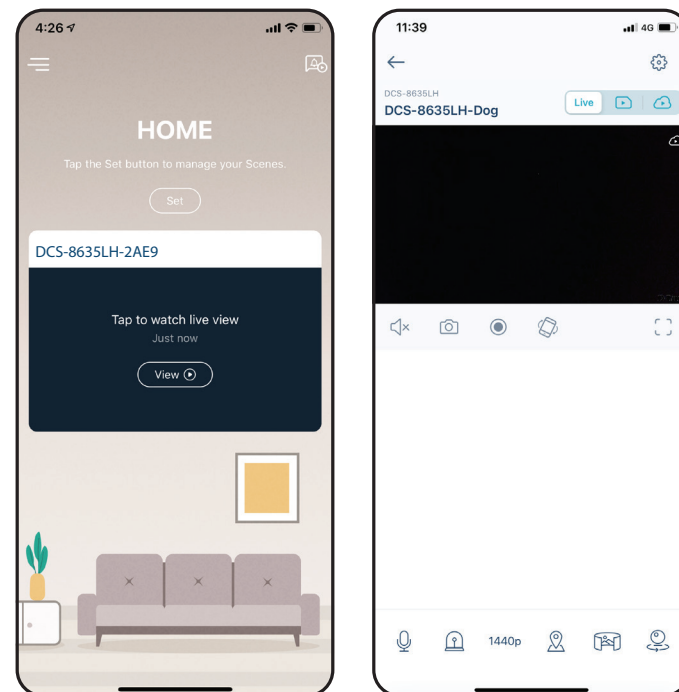

Note: Screenshots are representative only. The mydlink app is constantly being updated and so may appear different.

After setting up your DCS-8635LH 2K QHD Pan & Zoom Outdoor Wi-Fi Camera with a mydlink account in the mydlink app, you will be able to remotely access your camera through the app. After signing into your mydlink account, you will see a screen similar to the one on the right.

To access the device control options, tap to watch the live view, then tap again to access the control page. The following controls are available:

| | | |
|---|---------------------|--|
|  | Audio | Tap  to disable audio. Tap  to enable audio. |
|  | Snapshot | Tap  to take a snapshot of the video stream. |
|  | Recording | Tap  to enable video stream recording. |
|  | Tilt to move | Tap  to move your device sideways to control your camera. |
|  | Two Way Talk | Tap  to send your voice to the camera's built-in speaker. |
|  | Siren | Tap  to turn the siren on and off. The siren will turn off automatically after the timeout period has been reached. |



| | | |
|---|-------------------------|---|
| 1440p | Video Resolution | Tap 1440p to use 1440p resolution video. Tap 720P to use 720p resolution video. |
|  | Camera Presets | Save and quickly access up to 5 different camera views. The  button is your Home Point. To set other viewpoints, tap the  button, then tap the live view screen and use the arrows to set your view preset. Long press on the  button to save a snapshot of that location. |
|  | Point to Go | Use the  icon to tap anywhere on the panorama in order to change your live view. |
|  | Check Around | Tap  to move the field-of-view |

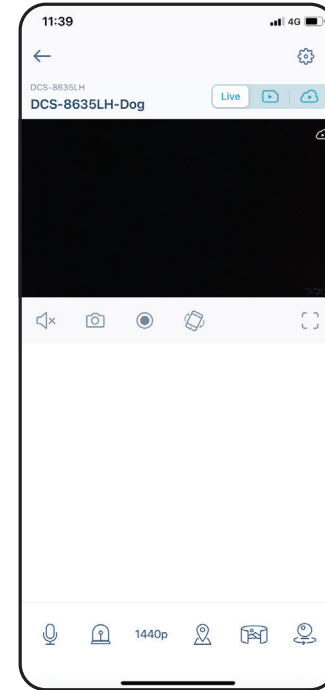

Device Settings

To access the Device Settings page:

1. Tap ☰.
2. Tap **Device Settings**.
3. Tap the device you want to access the settings for.

The device page contains several options for you to configure your camera.

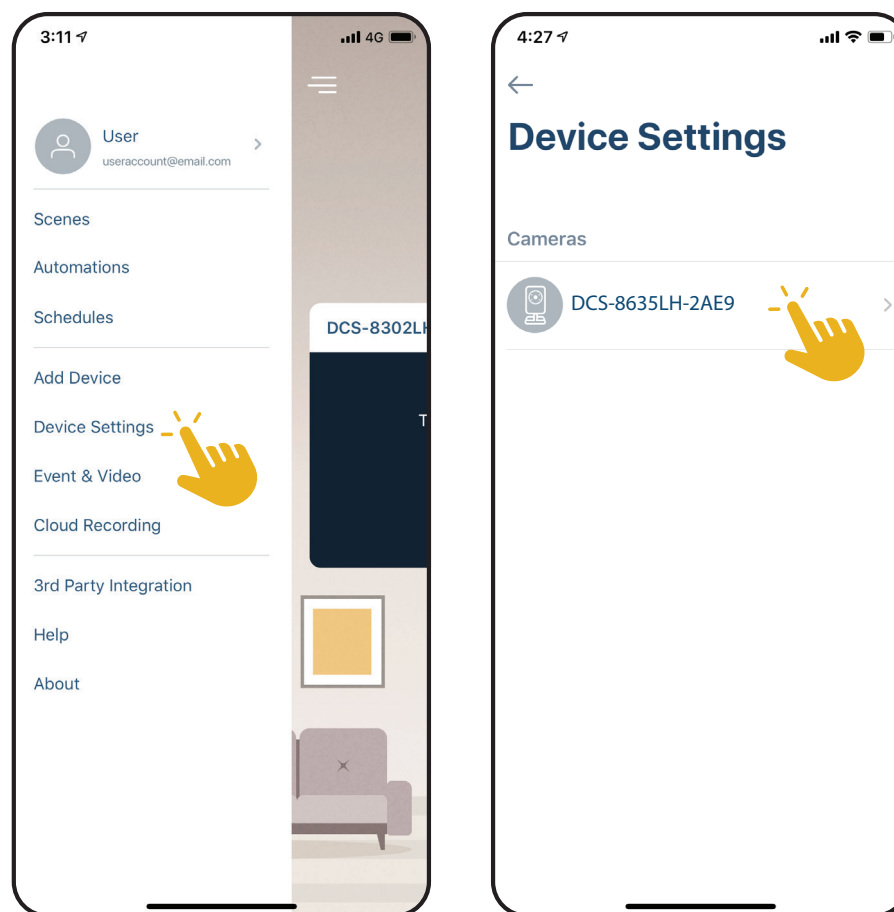

| | | |
|----|------------------------------------|---|
| 1 | Device Name | Tap to change the device's name. |
| 2 | Privacy Mode | Tap to enable. Privacy mode will disable the camera feed. |
| 3 | Motion and Person Detection | Tap to set the Motion and Person Detection area and sensitivity settings. |
| 4 | Point to Go | This photo is what you will see when you control your viewpoint in the camera's Point to Go live-view. Tap Rescan to scan a new panorama. |
| 5 | Auto Home | Enable to automatically return your camera to the set 'Home Point' after 60 seconds of inactivity. |
| 6 | Siren Timeout | Set the auto-off timer for the siren. This setting will apply to manual operation and Automations. |
| 7 | Storage | Tap to change the video clips storage location from the microSD card to the cloud. You can also subscribe to mydlink Cloud from here and view your current subscription plan. |
| 8 | Camera Microphone | Tap to enable or disable picking up sound near your camera in live view and recordings. |
| 9 | Color Night Vision | Tap to change night vision detection to On , Off or Auto . Color Night Vision is enabled by default and allows you to see color images while viewing the live feed in low light scenarios. |
| 10 | Anti-Flicker | Reduces flicker in the video. Tap 50 Hz or 60 Hz depending on the frequency of your lights. |
| 11 | Pan-Tilt Control | Choose whether to control your camera's Point to Go live-view pan-tilt control by swiping or tapping. |
| 12 | Status LED | Disabling this will turn off the LED until you turn it back on. |
| 13 | Designated Contact | Tap here to add, remove, or edit designated contacts that appear in the rich notification. |
| 14 | Wi-Fi | Tap to change the wireless network this device will use to connect to the Internet. Note: The network must be the same as all your other mydlink devices that you wish to use the same account for. |
| 15 | Time Zone | Select the time zone to calibrate your device to. |
| 16 | Firmware | This displays the installed version of the firmware on your device. Tap to enter the update settings. You can choose the most suitable time for automatic updates. |
| 17 | MAC ID | Identifies the device for support issues. |
| 18 | Restart Device | Tap this button to restart the device |
| 19 | Remove Device | Tap this button to disconnect this device from your mydlink account. |

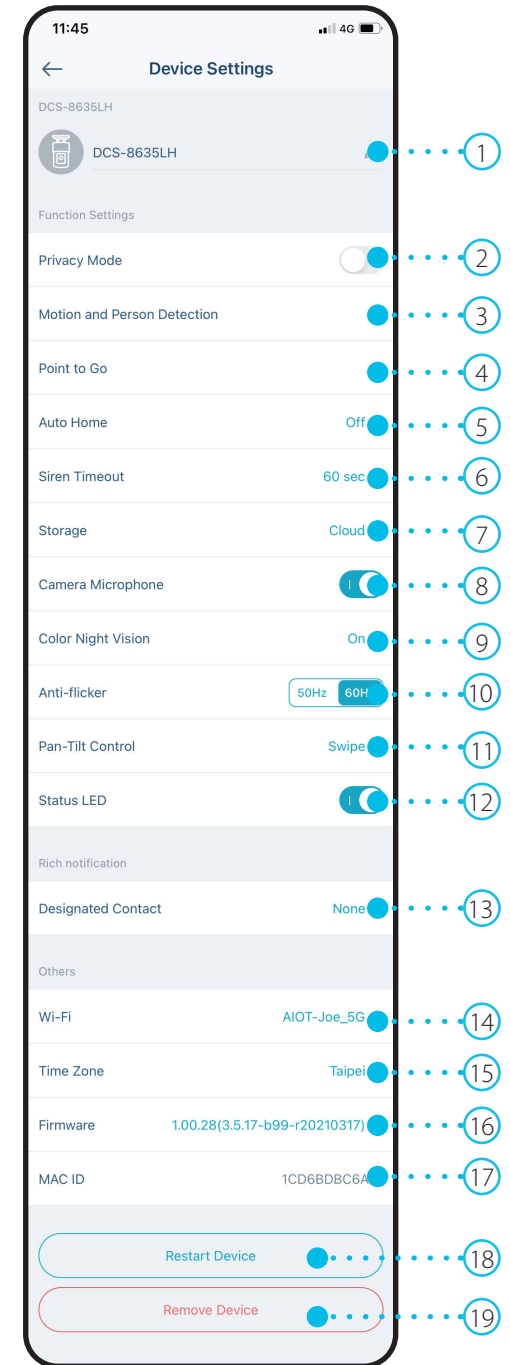

Troubleshooting

What do I do if my device is not working properly?

Reset the device and reinstall it. To reset your device, use a paper clip to press and hold the recessed Reset button until the LED turns solid red.

During installation, ensure that:

- your router is connected to the Internet and has Wi-Fi enabled
- your mobile device has Bluetooth enabled
- your mydlink device is in range of your Wi-Fi network

How can I use voice commands to control my device?

The device will work with both Amazon Alexa and the Google Assistant. For setup instructions on these services, visit the following websites:

Alexa: dlink.com/en/alexa

The Google Assistant: dlink.com/en/google-assistant

Why is my microSD card not working/not supported?

The microSD card must be formatted with the correct file system (FAT32) before it can be used with this product. This can be done in the mydlink app by selecting the Format function in the storage menu under the **Device Settings**.

What is my username and password for setting up my device with an ONVIF system?

To connect your device to an ONVIF system, enter “admin” as the username and use the PIN code of your mydlink device as the password. You can find the PIN code on your device’s label.

Technical Specifications

| General | |
|------------------------|--|
| Video Compression | • H.265 & H.264 |
| Max. Resolution | • 4 Megapixel (QHD) |
| Max. Frame | • 1440p (2560 x 1440) |
| Image Sensor | • 1/2.7" Progressive CMOS sensor |
| Day & Night - IR LED | • 7 m (23 ft) |
| Focal Length | • 3.3 mm |
| Aperture | • F2.0 |
| Angle of View | • (H) 105.4° (V) 56.4° (D) 125° |
| Motorized Pan | • Yes (-135° to +135° total 270°) |
| Audio | • Built-in microphone and speaker |
| Audio Codec | • MPEG-2 AAC LC |
| Functionality | |
| Wireless IEEE Standard | • 802.11n/ac wireless, 2T2R |
| Wi-Fi Operation Band | • Dual band 2.4 GHz & 5 GHz |
| Security Protocol | • WPA3, TLS |
| Bluetooth | • Bluetooth Low Energy 5.0 |
| Network Protocols | • IPv4, IPv6, DHCP/DHCPv6 Client, Bonjour (mDNS and DNS-SD), ONVIF Profile S/T, RTSP, SRTP, RTP, HTTPS |
| Software | |
| Device Management | • mydlink app (iOS and Android), mydlink Portal |
| Features | • Motion detection, person detection, sound detection, vehicle detection, glass break detection |
| Recording | • mydlink Cloud Recording, microSD card recording (Up to 256 GB capacity) |
| Notifications | • Push notifications with a snapshot and quick action buttons (2 designated contact numbers and live view) |
| Voice Assistants | • Amazon Alexa, the Google Assistant |
| Physical | |
| Power Input | • 100 to 240 V AC, 50/60 Hz |
| Power Output | • 12V 1A |
| Max. Power Consumption | • 7 W |
| Cable Length | • Device: 1 m (3.28 ft) • Adapter: 3 m (9.84 ft) |
| Indoor/Outdoor | • For outdoor use |

Appendix A - Technical Specifications

| | |
|----------------------------|--|
| Operating Temperature | • -25 to 45°C (-13 to 113°F) |
| Storage Temperature | • -20 to 70°C (-4 to 158°F) |
| Operating/Storage Humidity | • Max. 90% non-condensing |
| Weight | • 342 g (12 oz) |
| Dimensions | • 71 x 111.8 x 70 mm (2.8 x 4.4 x 2.75 in) |
| Certifications | • CE, FCC, IC, RCM, NCC, BSMI |

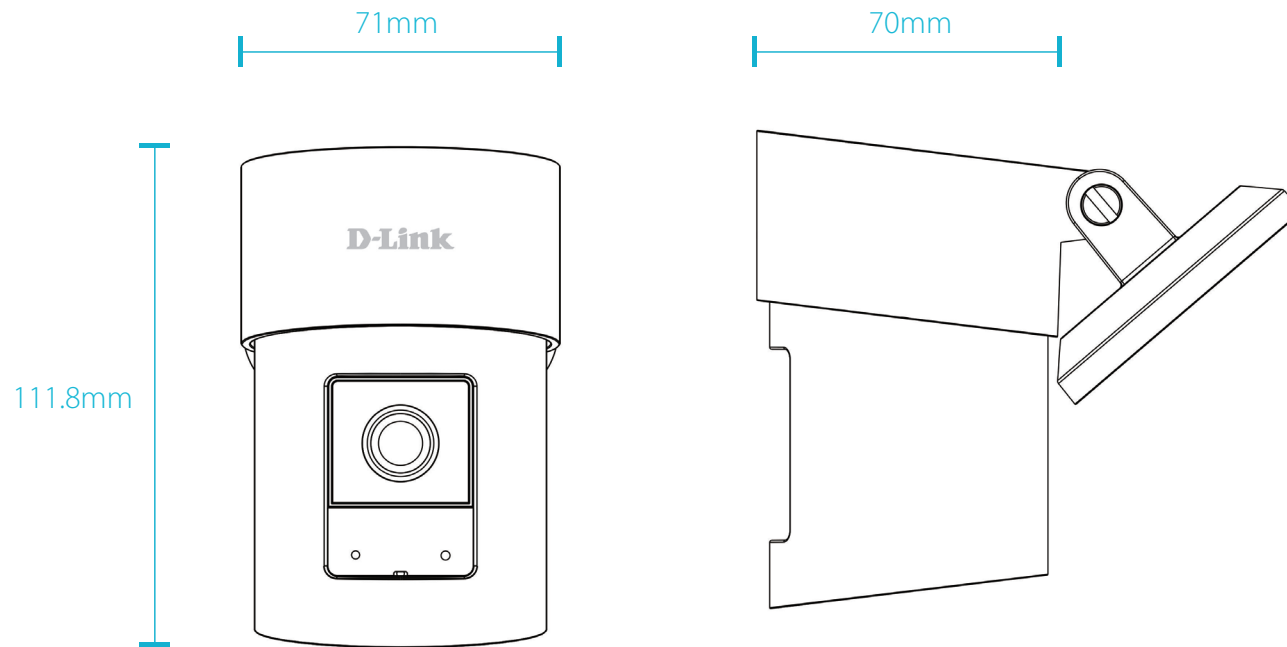

¹ Use of audio or video equipment for recording the image or audio of a person without their knowledge and consent is prohibited in certain states or jurisdictions. The end-user assumes all liability for compliance with applicable state, local and federal laws. ² microSD card not included. Supports capacity up to 256 GB.

Regulatory Information

Federal Communication Commission Interference Statement

This equipment has been tested and found to comply with the limits for a Class B digital device, pursuant to part 15 of the FCC Rules. These limits are designed to provide reasonable protection against harmful interference in a residential installation. This equipment generates, uses and can radiate radio frequency energy and, if not installed and used in accordance with the instructions, may cause harmful interference to radio communications. However, there is no guarantee that interference will not occur in a particular installation. If this equipment does cause harmful interference to radio or television reception, which can be determined by turning the equipment off and on, the user is encouraged to try to correct the interference by one or more of the following measures:

- Reorient or relocate the receiving antenna.
- Increase the separation between the equipment and receiver.
- Connect the equipment into an outlet on a circuit different from that to which the receiver is connected.
- Consult the dealer or an experienced radio/TV technician for help.

FCC Radiation Exposure Statement

This device complies with FCC radiation exposure limits set forth for an uncontrolled environment and it also complies with Part 15 of the FCC RF Rules. This equipment must be installed and operated in accordance with provided instructions and the antenna(s) used for this transmitter must be installed to provide a separation distance of at least 20 cm from all persons and must not be co-located or operating in conjunction with any other antenna or transmitter. End-users and installers must be provide with antenna installation instructions and consider removing the no-collocation statement.

This device complies with Part 15 of the FCC Rules. Operation is subject to the following two conditions:

1. This device may not cause harmful interference, and
2. This device must accept any interference received, including interference that may cause undesired operation.

Caution:

Any changes or modifications not expressly approved by the party responsible for compliance could void the user's authority to operate the equipment.

IC:

This device contains licence-exempt transmitter(s)/receiver(s) that comply with Innovation, Science and Economic Development Canada's licence-exempt RSS(s). Operation is subject to the following two conditions:

- (1) This device may not cause interference.
- (2) This device must accept any interference, including interference that may cause undesired operation of the device.

L'émetteur/récepteur exempt de licence contenu dans le présent appareil est conforme aux CNR d'Innovation, Sciences et Développement économique Canada applicables aux appareils radio exempts de licence. L'exploitation est autorisée aux deux conditions suivantes :

- 1) L'appareil ne doit pas produire de brouillage;
- 2) L'appareil doit accepter tout brouillage radioélectrique subi, même si le brouillage est susceptible d'en compromettre le fonctionnement.

The device meets the exemption from the routine evaluation limits in section 2.5 of RSS 102 and compliance with RSS-102 RF exposure, users can obtain Canadian information on RF exposure and compliance.

Le dispositif rencontre l'exemption des limites courantes d'évaluation dans la section 2.5 de RSS 102 et la conformité à l'exposition de RSS-102 rf, utilisateurs peut obtenir l'information canadienne sur l'exposition et la conformité de rf.

This transmitter must not be co-located or operating in conjunction with any other antenna or transmitter. This equipment should be installed and operated with a minimum distance of 20 centimeters between the radiator and your body.

Cet émetteur ne doit pas être Co-placé ou ne fonctionnant en même temps qu'aucune autre antenne ou émetteur. Cet équipement devrait être installé et actionné avec une distance minimum de 20 centimètres entre le radiateur et votre corps.

1. the device for operation in the band 5150–5250 MHz is only for indoor use to reduce the potential for harmful interference to co-channel mobile satellite systems;
2. for devices with detachable antenna(s), the maximum antenna gain permitted for devices in the bands 5250-5350 MHz and 5470-5725 MHz shall be such that the equipment still complies with the e.i.r.p. limit;
3. for devices with detachable antenna(s), the maximum antenna gain permitted for devices in the band 5725-5850 MHz shall be such that the equipment still complies with the e.i.r.p. limits specified for point-to-point and non-point-to-point operation as appropriate.

- 1.les dispositifs fonctionnant dans la bande 5150-5250 MHz sont réservés uniquement pour une utilisation à l'intérieur afin de réduire les risques de brouillage préjudiciable aux systèmes de satellites mobiles utilisant les mêmes canaux;
- 2.le gain maximal d'antenne permis pour les dispositifs utilisant les bandes 5250-5350 MHz et 5470-5725 MHz doit se conformer à la limite de p.i.r.e.;
- 3.le gain maximal d'antenne permis (pour les dispositifs utilisant la bande 5725-5850 MHz) doit se conformer à la limite de p.i.r.e. spécifiée pour l'exploitation point à point et non point à point, selon le cas.

以下警語適用台灣地區

取得審驗證明之低功率射頻器材，非經核准，公司、商號或使用者均不得擅自變更頻率、加大功率或變更原設計之特性及功能。低功率射頻器材之使用不得影響飛航安全及干擾合法通信；經發現有干擾現象時，應立即停用，並改善至無干擾時方得繼續使用。前述合法通信，指依電信管理法規定作業之無線電通信。低功率射頻器材須忍受合法通信或工業、科學及醫療用電波輻射性電機設備之干擾。

應避免影響附近雷達系統之操作。高增益指向性天線只得應用於固定式點對點系統。



| | Frequency Band(s) Frequenzband Fréquence bande(s) Bandas de Frecuencia Frequenza/e Frequentie(s) | Max. Output Power (EIRP) Max. Output Power Consommation d'énergie max. Potencia máxima de Salida Potenza max. Output Max. Output Power |
|-------|---|---|
| 2.4 G | 2.4 – 2.4835 GHz | 100 mW |

European Community Declaration of Conformity:

| | |
|--------------------|---|
| Česky [Czech] | Tímto D-Link Corporation prohlašuje, že tento produkt, jeho příslušenství a software jsou v souladu se směrnicí 2014/53/EU. Celý text ES prohlášení o shodě vydaného EU a o firmwaru produktu lze stáhnout na stránkách k produktu www.dlink.com . |
| Dansk [Danish] | D-Link Corporation erklærer herved, at dette produkt, tilbehør og software er i overensstemmelse med direktiv 2014/53/EU. Den fulde tekst i EU-overensstemmelseserklæringen og produktfirmware kan wnloades fra produktsiden hos www.dlink.com . |
| Deutsch [German] | Hiermit erklärt die D-Link Corporation, dass dieses Produkt, das Zubehör und die Software der Richtlinie 2014/53/EU entsprechen. Der vollständige Text der Konformitätserklärung der Europäischen Gemeinschaft sowie die Firmware zum Produkt stehen Ihnen zum Herunterladen von der Produktseite im Internet auf www.dlink.com zur Verfügung. |
| Eesti [Estonian] | Käesolevaga kinnitab D-Link Corporation, et see toode, tarvikud ja tarkvara on kooskõlas direktiiviga 2014/53/EL. Euroopa Liidu vastavusdeklaratsiooni täistekst ja toote püsivara on allalaadimiseks saadaval tootelehel www.dlink.com . |
| English | Hereby, D-Link Corporation, declares that this product, accessories, and software are in compliance with directive 2014/53/EU. The full text of the EU Declaration of Conformity and product firmware are available for download from the product page at www.dlink.com |
| Español [Spanish] | Por la presente, D-Link Corporation declara que este producto, accesorios y software cumplen con las directivas 2014/53/UE. El texto completo de la declaración de conformidad de la UE y el firmware del producto están disponibles y se pueden descargar desde la página del producto en www.dlink.com . |
| Ελληνική [Greek] | Με την παρούσα, η D-Link Corporation δηλώνει ότι αυτό το προϊόν, τα αξεσουάρ και το λογισμικό συμμορφώνονται με την Οδηγία 2014/53/ΕΕ. Το πλήρες κείμενο της δήλωσης συμμόρφωσης της ΕΕ και το υλικολογισμικό του προϊόντος είναι διαθέσιμα για λήψη από τη σελίδα του προϊόντος στην τοποθεσία www.dlink.com . |
| Français [French] | Par les présentes, D-Link Corporation déclare que ce produit, ces accessoires et ce logiciel sont conformes aux directives 2014/53/UE. Le texte complet de la déclaration de conformité de l'UE et le icroprogramme du produit sont disponibles au téléchargement sur la page des produits à www.dlink.com . |
| Italiano [Italian] | Con la presente, D-Link Corporation dichiara che questo prodotto, i relativi accessori e il software sono conformi alla direttiva 2014/53/UE. Il testo completo della dichiarazione di conformità UE e il firmware del prodotto sono disponibili per il download dalla pagina del prodotto su www.dlink.com . |

| | |
|------------------------|--|
| Latviski [Latvian] | Ar šo uzņēmums D-Link Corporation apliecina, ka šis produkts, piederumi un programmatūra atbilst direktīvai 2014/53/ES. ES atbilstības deklarācijas pilno tekstu un produkta aparātprogrammatūru var lejupielādēt attiecīgā produkta lapā vietnē www.dlink.com . |
| Lietuvių [Lithuanian] | Šiuo dokumentu „D-Link Corporation“ pareiškia, kad šis gaminys, priedai ir programinė įranga atitinka direktyvą 2014/53/ES. Visą ES atitikties deklaracijos tekstą ir gaminio programinę aparatinę įrangą galima atsisiųsti iš gaminio puslapio adresu www.dlink.com . |
| Nederlands [Dutch] | Hierbij verklaart D-Link Corporation dat dit product, accessoires en software voldoen aan de richtlijnen 2014/53/EU. De volledige tekst van de EU conformiteitsverklaring en productfirmware is beschikbaar voor download van de productpagina op www.dlink.com . |
| Malti [Maltese] | Bil-preżenti, D-Link Corporation tiddikjara li dan il-prodott, l-aċċessorji, u s-software huma konformi mad-Direttiva 2014/53/UE. Tista' tniżżel it-test sħiħ tad-dikjarazzjoni ta' konformità tal-UE u l-firmware tal-prodott mill-paġna tal-prodott fuq www.dlink.com . |
| Magyar [Hungarian] | Ezennel a D-Link Corporation kijelenti, hogy a jelen termék, annak tartozékai és szoftvere megfelelnek a 2014/53/EU sz. rendeletnek. Az EU Megfelelőségi nyilatkozat teljes szövege és a termék firmware a termék oldaláról tölthető le a www.dlink.com címen. |
| Polski [Polish] | D-Link Corporation niniejszym oświadcza, że ten produkt, akcesoria oraz oprogramowanie są zgodne z dyrektywami 2014/53/EU. Pełen tekst deklaracji zgodności UE oraz oprogramowanie sprzętowe do produktu można pobrać na stronie produktu w witrynie www.dlink.com . |
| Português [Portuguese] | Desta forma, a D-Link Corporation declara que este produto, os acessórios e o software estão em conformidade com a diretiva 2014/53/UE. O texto completo da declaração de conformidade da UE e do firmware |
| Slovensko[Slovenian] | Podjetje D-Link Corporation s tem izjavlja, da so ta izdelek, dodatna oprema in programska oprema skladni z direktivami 2014/53/EU. Celotno besedilo izjave o skladnosti EU in vdelana programska oprema sta na voljo za prenos na strani izdelka na www.dlink.com . |
| Slovensky [Slovak] | Spoločnosť D-Link týmto vyhlasuje, že tento produkt, príslušenstvo a softvér sú v súlade so smernicou 214/53/EÚ. Úplné znenie vyhlásenia EÚ o zhode a firmvéri produktu sú k dispozícii na prevzatie zo stránky produktu www.dlink.com . |
| Suomi [Finnish] | D-Link Corporation täten vakuuttaa, että tämä tuote, lisävarusteet ja ohjelmisto ovat direktiivin 2014/53/EU vaatimusten mukaisia. Täydellinen EU-vaatimustenmukaisuusvakuutus samoin kuin tuotteen laiteohjelmisto ovat ladattavissa osoitteesta www.dlink.com . |

| | |
|----------------------|---|
| Svenska [Swedish] | D-Link Corporation försäkrar härmed att denna produkt, tillbehör och programvara överensstämmer med direktiv 2014/53/EU. Hela texten med EU-försäkran om överensstämmelse och produkt-firmware kan hämtas från produktsidan på www.dlink.com . |
| Íslenska [Icelandic] | Hér með lýsir D-Link Corporation því yfir að þessi vara, fylgihlutir og hugbúnaður eru í samræmi við tilskipun 2014/53/EB. Sækja má ESB-samræmisýfirlýsinguna í heild sinni og fastbúnað vörunnar af vefsíðu vörunnar á www.dlink.com . |
| Norsk [Norwegian] | Herved erklærer D-Link Corporation at dette produktet, tilbehøret og programvaren er i samsvar med direktivet 2014/53/EU. Den fullstendige teksten i EU-erklæring om samsvar og produktets fastvare er tilgjengelig for nedlasting fra produktsiden på www.dlink.com . |

Warning Statement:

The power outlet should be near the device and easily accessible.

NOTICE OF WIRELESS RADIO LAN USAGE IN THE EUROPEAN COMMUNITY (FOR WIRELESS PRODUCT ONLY):

- This device is restricted to indoor use when operated in the European Community using channels in the 5.15-5.35 GHz band to reduce the potential for interference.
- This device is a 2.4 GHz wideband transmission system (transceiver), intended for use in all EU member states and EFTA countries. This equipment may be operated in AL, AD, BE, BG, DK, DE, FI, FR, GR, GW, IS, IT, HR, LI, LU, MT, MK, MD, MC, NL, NO, AT, PL, PT, RO, SM, SE, RS, SK, ES, CI, HU, and CY.

Usage Notes:

- To remain in conformance with European National spectrum usage regulations, frequency and channel limitations will be applied on the products according to the country where the equipment will be deployed.
- This device is restricted from functioning in Ad-hoc mode while operating in 5 GHz. Ad-hoc mode is direct peer-to-peer communication between two client devices without an Access Point.
- Access points will support DFS (Dynamic Frequency Selection) and TPC (Transmit Power Control) functionality as required when operating in 5 GHz band within the EU.
- Please refer to the product manual or datasheet to check whether your product uses 2.4 GHz and/or 5 GHz wireless.

HINWEIS ZUR VERWENDUNG VON DRAHTLOS-NETZWERK (WLAN) IN DER EUROPÄISCHEN GEMEINSCHAFT (NUR FÜR EIN DRAHTLOSES PRODUKT)

- Der Betrieb dieses Geräts in der Europäischen Gemeinschaft bei Nutzung von Kanälen im 5,15-5,35 GHz Frequenzband ist ausschließlich auf Innenräume beschränkt, um das Interferenzpotential zu reduzieren.
- Bei diesem Gerät handelt es sich um ein zum Einsatz in allen EU-Mitgliedsstaaten und in EFTA-Ländern - ausgenommen Frankreich. Der Betrieb dieses Geräts ist in den folgenden Ländern erlaubt: AL, AD, BE, BG, DK, DE, FI, FR, GR, GW, IS, IT, HR, LI, LU, MT, MK, MD, MC, NL, NO, AT, PL, PT, RO, SM, SE, RS, SK, ES, CI, HU, CY

Gebrauchshinweise:

- Um den in Europa geltenden nationalen Vorschriften zum Nutzen des Funkspektrums weiterhin zu entsprechen, werden Frequenz und Kanalbeschränkungen, dem jeweiligen Land, in dem das Gerät zum Einsatz kommt, entsprechend, auf die Produkte angewandt.
- Die Funktionalität im Ad-hoc-Modus bei Betrieb auf 5 GHz ist für dieses Gerät eingeschränkt. Bei dem Ad-hoc-Modus handelt es sich um eine Peer-to-Peer-Kommunikation zwischen zwei Client-Geräten ohne einen Access Point.
- Access Points unterstützen die Funktionen DFS (Dynamic Frequency Selection) und TPC (Transmit Power Control) wie erforderlich bei Betrieb auf 5 GHz innerhalb der EU.
- Bitte schlagen Sie im Handbuch oder Datenblatt nach, ob Ihr Gerät eine 2,4 GHz und / oder 5 GHz Verbindung nutzt.

AVIS CONCERNANT L'UTILISATION DE LA RADIO SANS FIL LAN DANS LA COMMUNAUTÉ EUROPÉENNE (UNIQUEMENT POUR LES PRODUITS SANS FIL)

- Cet appareil est limité à un usage intérieur lorsqu'il est utilisé dans la Communauté européenne sur les canaux de la bande de 5,15 à 5,35 GHz afin de réduire les risques d'interférences.
- Cet appareil est un système de transmission à large bande (émetteur-récepteur) de 2,4 GHz, destiné à être utilisé dans tous les États-membres de l'UE et les pays de l'AELE. Cet équipement peut être utilisé dans les pays suivants : AL, AD, BE, BG, DK, DE, FI, FR, GR, GW, IS, IT, HR, LI, LU, MT, MK, MD, MC, NL, NO, AT, PL, PT, RO, SM, SE, RS, SK, ES, CI, HU, CY

Notes d'utilisation:

- Pour rester en conformité avec la réglementation nationale européenne en matière d'utilisation du spectre, des limites de fréquence et de canal seront appliquées aux produits selon le pays où l'équipement sera déployé.
- Cet appareil ne peut pas utiliser le mode Ad-hoc lorsqu'il fonctionne dans la bande de 5 GHz. Le mode Adhoc fournit une communication directe pair à pair entre deux périphériques clients sans point d'accès.
- Les points d'accès prendront en charge les fonctionnalités DFS (Dynamic Frequency Selection) et TPC (Transmit Power Control) au besoin lors du fonctionnement dans la bande de 5 GHz au sein de l'UE.
- Merci de vous référer au guide d'utilisation ou de la fiche technique afin de vérifier si votre produit utilise 2.4 GHz et/ou 5 GHz sans fil.

AVISO DE USO DE LA LAN DE RADIO INALÁMBRICA EN LA COMUNIDAD EUROPEA (SOLO PARA EL PRODUCTO INALÁMBRICO)

- El uso de este dispositivo está restringido a interiores cuando funciona en la Comunidad Europea utilizando canales en la banda de 5,15-5,35 GHz, para reducir la posibilidad de interferencias.
- Este dispositivo es un sistema de transmisión (transceptor) de banda ancha de 2,4 GHz, pensado para su uso en todos los estados miembros de la UE y en los países de la AELC. Este equipo se puede utilizar en AL, AD, BE, BG, DK, DE, FI, FR, GR, GW, IS, IT, HR, LI, LU, MT, MK, MD, MC, NL, NO, AT, PL, PT, RO, SM, SE, RS, SK, ES, CI, HU, CY

Notas de uso:

- Para seguir cumpliendo las normas europeas de uso del espectro nacional, se aplicarán limitaciones de frecuencia y canal en los productos en función del país en el que se pondrá en funcionamiento el equipo.
- Este dispositivo tiene restringido el funcionamiento en modo Ad-hoc mientras funcione a 5 Ghz. El modo Ad-hoc es la comunicación directa de igual a igual entre dos dispositivos cliente sin un punto de acceso.
- Los puntos de acceso admitirán la funcionalidad DFS (Selección de frecuencia dinámica) y TPC (Control de la potencia de transmisión) si es necesario cuando funcionan a 5 Ghz dentro de la UE.
- Por favor compruebe el manual o la ficha de producto para comprobar si el producto utiliza las bandas inalámbricas de 2.4 GHz y/o la de 5 GHz.

AVVISO PER L'USO DI LAN RADIO WIRELESS NELLA COMUNITÀ EUROPEA (SOLO PER PRODOTTI WIRELESS)

- Nella Comunità europea, l'uso di questo dispositivo è limitato esclusivamente agli ambienti interni sui canali compresi nella banda da 5,15 a 5,35 GHz al fine di ridurre potenziali interferenze. Questo dispositivo è un sistema di trasmissione a banda larga a 2,4 GHz (ricetrasmittente), destinato all'uso in tutti gli stati membri dell'Unione europea e nei paesi EFTA.
- Questo dispositivo può essere utilizzato in AL, AD, BE, BG, DK, DE, FI, FR, GR, GW, IS, IT, HR, LI, LU, MT, MK, MD, MC, NL, NO, AT, PL, PT, RO, SM, SE, RS, SK, ES, CI, HU, CY

Note per l'uso

- Al fine di mantenere la conformità alle normative nazionali europee per l'uso dello spettro di frequenze, saranno applicate limitazioni sulle frequenze e sui canali per il prodotto in conformità alle normative del paese in cui il dispositivo viene utilizzato.
- Questo dispositivo non può essere attivato in modalità Ad-hoc durante il funzionamento a 5 GHz. La modalità Ad-hoc è una comunicazione diretta peer-to-peer fra due dispositivi client senza un punto di accesso.
- I punti di accesso supportano le funzionalità DFS (Dynamic Frequency Selection) e TPC (Transmit Power Control) richieste per operare a 5 GHz nell'Unione europea.
- Ti invitiamo a fare riferimento al manuale del prodotto o alla scheda tecnica per verificare se il tuo prodotto utilizza le frequenze 2,4 GHz e/o 5 GHz.

KENNISGEVING VAN DRAADLOOS RADIO LAN-GEbruik IN DE EUROPESE GEMEENSCHAP (ALLEEN VOOR DRAADLOOS PRODUCT)

- Dit toestel is beperkt tot gebruik binnenshuis wanneer het wordt gebruikt in de Europese Gemeenschap gebruik makend van kanalen in de 5.15-5.35 GHz band om de kans op interferentie te beperken.
- Dit toestel is een 2.4 GHz breedband transmissiesysteem (transceiver) dat bedoeld is voor gebruik in alle EU lidstaten en EFTA landen. Deze uitrusting mag gebruikt worden in AL, AD, BE, BG, DK, DE, FI, FR, GR, GW, IS, IT, HR, LI, LU, MT, MK, MD, MC, NL, NO, AT, PL, PT, RO, SM, SE, RS, SK, ES, CI, HU, CY

Gebruiksaanwijzingen:

- Om de gebruiksvoorschriften van het Europese Nationale spectrum na te leven, zullen frequentie- en kanaalbeperkingen worden toegepast op de producten volgens het land waar de uitrusting gebruikt zal worden.
- Dit toestel kan niet functioneren in Ad-hoc mode wanneer het gebruikt wordt in 5 GHz. Ad-hoc mode is directe peer-to-peer communicatie tussen twee klantenapparaten zonder een toegangspunt.
- Toegangspunten ondersteunen DFS (Dynamic Frequency Selection) en TPC (Transmit Power Control) functionaliteit zoals vereist bij gebruik in 5 GHz binnen de EU.
- Raadpleeg de handleiding of de datasheet om te controleren of uw product gebruik maakt van 2.4 GHz en/of 5 GHz.

SAFETY INSTRUCTIONS

The following general safety guidelines are provided to help ensure your own personal safety and protect your product from potential damage. Remember to consult the product user instructions for more details.

- Static electricity can be harmful to electronic components. Discharge static electricity from your body (i.e. touching grounded bare metal) before touching the product.
- Do not attempt to service the product and never disassemble the product. For some products with a user replaceable battery, please read and follow the instructions in the user manual.
- Do not spill food or liquid on your product and never push any objects into the openings of your product.
- Do not use this product near water, areas with high humidity, or condensation unless the product is specifically rated for outdoor application.
- Keep the product away from radiators and other heat sources.
- Always unplug the product from mains power before cleaning and use a dry lint free cloth only.

SICHERHEITSVORSCHRIFTEN

Die folgenden allgemeinen Sicherheitsvorschriften dienen als Hilfe zur Gewährleistung Ihrer eigenen Sicherheit und zum Schutz Ihres Produkts. Weitere Details finden Sie in den Benutzeranleitungen zum Produkt.

- Statische Elektrizität kann elektronischen Komponenten schaden. Um Schäden durch statische Aufladung zu vermeiden, leiten Sie elektrostatische Ladungen von Ihrem Körper ab, (z. B. durch Berühren eines geerdeten blanken Metallteils), bevor Sie das Produkt berühren.
- Unterlassen Sie jeden Versuch, das Produkt zu warten, und versuchen Sie nicht, es in seine Bestandteile zu zerlegen. Für einige Produkte mit austauschbaren Akkus lesen Sie bitte das Benutzerhandbuch und befolgen Sie die dort beschriebenen Anleitungen.
- Vermeiden Sie, dass Speisen oder Flüssigkeiten auf Ihr Produkt gelangen, und stecken Sie keine Gegenstände in die Gehäuseschlitze oder -öffnungen Ihres Produkts.
- Verwenden Sie dieses Produkt nicht in unmittelbarer Nähe von Wasser und nicht in Bereichen mit hoher Luftfeuchtigkeit oder Kondensation, es sei denn, es ist speziell zur Nutzung in Außenbereichen vorgesehen und eingestuft.
- Halten Sie das Produkt von Heizkörpern und anderen Quellen fern, die Wärme erzeugen.
- Trennen Sie das Produkt immer von der Stromzufuhr, bevor Sie es reinigen und verwenden Sie dazu ausschließlich ein trockenes fusselfreies Tuch.

CONSIGNES DE SÉCURITÉ

Les consignes générales de sécurité ci-après sont fournies afin d'assurer votre sécurité personnelle et de protéger le produit d'éventuels dommages. Veuillez consulter les consignes d'utilisation du produit pour plus de détails.

- L'électricité statique peut endommager les composants électroniques. Déchargez l'électricité statique de votre corps (en touchant un objet en métal relié à la terre par exemple) avant de toucher le produit.
- N'essayez pas d'intervenir sur le produit et ne le démontez jamais. Pour certains produits contenant une batterie remplaçable par l'utilisateur, veuillez lire et suivre les consignes contenues dans le manuel d'utilisation.
- Ne renversez pas d'aliments ou de liquide sur le produit et n'insérez jamais d'objets dans les orifices.
- N'utilisez pas ce produit à proximité d'un point d'eau, de zones très humides ou de condensation sauf si le produit a été spécifiquement conçu pour une application extérieure.
- Éloignez le produit des radiateurs et autres sources de chaleur.
- Débranchez toujours le produit de l'alimentation avant de le nettoyer et utilisez uniquement un chiffon sec non pelucheux.

INSTRUCCIONES DE SEGURIDAD

Las siguientes directrices de seguridad general se facilitan para ayudarle a garantizar su propia seguridad personal y para proteger el producto frente a posibles daños. No olvide consultar las instrucciones del usuario del producto para obtener más información.

- La electricidad estática puede resultar nociva para los componentes electrónicos. Descargue la electricidad estática de su cuerpo (p. ej., tocando algún metal sin revestimiento conectado a tierra) antes de tocar el producto.
- No intente realizar el mantenimiento del producto ni lo desmonte nunca. Para algunos productos con batería reemplazable por el usuario, lea y siga las instrucciones del manual de usuario.
- No derrame comida o líquidos sobre el producto y nunca deje que caigan objetos en las aberturas del mismo.
- No utilice este producto cerca del agua, en zonas con humedad o condensación elevadas a menos que el producto esté clasificado específicamente para aplicación en exteriores.
- Mantenga el producto alejado de los radiadores y de otras fuentes de calor.
- Desenchufe siempre el producto de la alimentación de red antes de limpiarlo y utilice solo un paño seco sin pelusa.

ISTRUZIONI PER LA SICUREZZA

Le seguenti linee guida sulla sicurezza sono fornite per contribuire a garantire la sicurezza personale degli utenti e a proteggere il prodotto da potenziali danni. Per maggiori dettagli, consultare le istruzioni per l'utente del prodotto.

- L'elettricità statica può essere pericolosa per i componenti elettronici. Scaricare l'elettricità statica dal corpo (ad esempio toccando una parte metallica collegata a terra) prima di toccare il prodotto.
- Non cercare di riparare il prodotto e non smontarlo mai. Per alcuni prodotti dotati di batteria sostituibile dall'utente, leggere e seguire le istruzioni riportate nel manuale dell'utente.
- Non versare cibi o liquidi sul prodotto e non spingere mai alcun oggetto nelle aperture del prodotto.
- Non usare questo prodotto vicino all'acqua, in aree con elevato grado di umidità o soggette a condensa a meno che il prodotto non sia specificatamente approvato per uso in ambienti esterni.
- Tenere il prodotto lontano da caloriferi e altre fonti di calore.
- Scollegare sempre il prodotto dalla presa elettrica prima di pulirlo e usare solo un panno asciutto che non lasci filacce.

VEILIGHEIDSINFORMATIE

De volgende algemene veiligheidsinformatie werd verstrekt om uw eigen persoonlijke veiligheid te waarborgen en uw product te beschermen tegen mogelijke schade. Denk eraan om de gebruikersinstructies van het product te raadplegen voor meer informatie.

- Statische elektriciteit kan schadelijk zijn voor elektronische componenten. Ontlaad de statische elektriciteit van uw lichaam (d.w.z. het aanraken van geaard bloot metaal) voordat u het product aanraakt.
- U mag nooit proberen het product te onderhouden en u mag het product nooit demonteren. Voor sommige producten met door de gebruiker te vervangen batterij, dient u de instructies in de gebruikershandleiding te lezen en te volgen.
- Mors geen voedsel of vloeistof op uw product en u mag nooit voorwerpen in de openingen van uw product duwen.
- Gebruik dit product niet in de buurt van water, gebieden met hoge vochtigheid of condensatie, tenzij het product specifiek geclassificeerd is voor gebruik buitenshuis.
- Houd het product uit de buurt van radiators en andere warmtebronnen.
- U dient het product steeds los te koppelen van de stroom voordat u het reinigt en gebruik uitsluitend een droge pluisvrije doek.

Disposing of and Recycling Your Product

ENGLISH

EN



This symbol on the product or packaging means that according to local laws and regulations this product should not be disposed of in household waste but sent for recycling. Please take it to a collection point designated by your local authorities once it has reached the end of its life, some will accept products for free. By recycling the product and its packaging in this manner you help to conserve the environment and protect human health.

D-Link and the Environment

At D-Link, we understand and are committed to reducing any impact our operations and products may have on the environment. To minimise this impact D-Link designs and builds its products to be as environmentally friendly as possible, by using recyclable, low toxic materials in both products and packaging.

D-Link recommends that you always switch off or unplug your D-Link products when they are not in use. By doing so you will help to save energy and reduce CO2 emissions.

To learn more about our environmentally responsible products and packaging please visit www.dlinkgreen.com.

DEUTSCH

DE



Dieses Symbol auf dem Produkt oder der Verpackung weist darauf hin, dass dieses Produkt gemäß bestehender örtlicher Gesetze und Vorschriften nicht über den normalen Hausmüll entsorgt werden sollte, sondern einer Wiederverwertung zuzuführen ist. Bringen Sie es bitte zu einer von Ihrer Kommunalbehörde entsprechend amtlich ausgewiesenen Sammelstelle, sobald das Produkt das Ende seiner Nutzungsdauer erreicht hat. Für die Annahme solcher Produkte erheben einige dieser Stellen keine Gebühren. Durch ein auf diese Weise durchgeführtes Recycling des Produkts und seiner Verpackung helfen Sie, die Umwelt zu schonen und die menschliche Gesundheit zu schützen.

D-Link und die Umwelt

D-Link ist sich den möglichen Auswirkungen seiner Geschäftstätigkeiten und seiner Produkte auf die Umwelt bewusst und fühlt sich verpflichtet, diese entsprechend zu mindern. Zu diesem Zweck entwickelt und stellt D-Link seine Produkte mit dem Ziel größtmöglicher Umweltfreundlichkeit her und verwendet wiederverwertbare, schadstoffarme Materialien bei Produktherstellung und Verpackung.

D-Link empfiehlt, Ihre Produkte von D-Link, wenn nicht in Gebrauch, immer auszuschalten oder vom Netz zu nehmen. Auf diese Weise helfen Sie, Energie zu sparen und CO2-Emissionen zu reduzieren.

Wenn Sie mehr über unsere umweltgerechten Produkte und Verpackungen wissen möchten, finden Sie entsprechende Informationen im Internet unter www.dlinkgreen.com.

FRANÇAIS**FR**

Ce symbole apposé sur le produit ou son emballage signifie que, conformément aux lois et réglementations locales, ce produit ne doit pas être éliminé avec les déchets domestiques mais recyclé. Veuillez le rapporter à un point de collecte prévu à cet effet par les autorités locales; certains accepteront vos produits gratuitement. En recyclant le produit et son emballage de cette manière, vous aidez à préserver l'environnement et à protéger la santé de l'homme.

D-Link et l'environnement

Chez D-Link, nous sommes conscients de l'impact de nos opérations et produits sur l'environnement et nous engageons à le réduire. Pour limiter cet impact, D-Link conçoit et fabrique ses produits de manière aussi écologique que possible, en utilisant des matériaux recyclables et faiblement toxiques, tant dans ses produits que ses emballages.

D-Link recommande de toujours éteindre ou débrancher vos produits D-Link lorsque vous ne les utilisez pas. Vous réaliserez ainsi des économies d'énergie et réduirez vos émissions de CO₂.

Pour en savoir plus sur les produits et emballages respectueux de l'environnement, veuillez consulter le www.dlinkgreen.com.

ESPAÑOL**ES**

Este símbolo en el producto o el embalaje significa que, de acuerdo con la legislación y la normativa local, este producto no se debe desechar en la basura doméstica sino que se debe reciclar. Llévelo a un punto de recogida designado por las autoridades locales una vez que ha llegado al fin de su vida útil; algunos de ellos aceptan recogerlos de forma gratuita. Al reciclar el producto y su embalaje de esta forma, contribuye a preservar el medio ambiente y a proteger la salud de los seres humanos.

D-Link y el medio ambiente

En D-Link, comprendemos y estamos comprometidos con la reducción del impacto que puedan tener nuestras actividades y nuestros productos en el medio ambiente. Para reducir este impacto, D-Link diseña y fabrica sus productos para que sean lo más ecológicos posible, utilizando materiales reciclables y de baja toxicidad tanto en los productos como en el embalaje.

D-Link recomienda apagar o desenchufar los productos D-Link cuando no se estén utilizando. Al hacerlo, contribuirá a ahorrar energía y a reducir las emisiones de CO₂.

Para obtener más información acerca de nuestros productos y embalajes ecológicos, visite el sitio www.dlinkgreen.com.

ITALIANO**IT**

La presenza di questo simbolo sul prodotto o sulla confezione del prodotto indica che, in conformità alle leggi e alle normative locali, questo prodotto non deve essere smaltito nei rifiuti domestici, ma avviato al riciclo. Una volta terminato il ciclo di vita utile, portare il prodotto presso un punto di raccolta indicato dalle autorità locali. Alcuni questi punti di raccolta accettano gratuitamente i prodotti da riciclare. Scegliendo di riciclare il prodotto e il relativo imballaggio, si contribuirà a preservare l'ambiente e a salvaguardare la salute umana.

D-Link e l'ambiente

D-Link cerca da sempre di ridurre l'impatto ambientale dei propri stabilimenti e dei propri prodotti. Allo scopo di ridurre al minimo tale impatto, D-Link progetta e realizza i propri prodotti in modo che rispettino il più possibile l'ambiente, utilizzando materiali riciclabili a basso tasso di tossicità sia per i prodotti che per gli imballaggi.

D-Link raccomanda di spegnere sempre i prodotti D-Link o di scollegarne la spina quando non vengono utilizzati. In questo modo si contribuirà a risparmiare energia e a ridurre le emissioni di anidride carbonica.

Per ulteriori informazioni sui prodotti e sugli imballaggi D-Link a ridotto impatto ambientale, visitate il sito all'indirizzo www.dlinkgreen.com.

NEDERLANDS**NL**

Dit symbool op het product of de verpakking betekent dat dit product volgens de plaatselijke wetgeving niet mag worden weggegooid met het huishoudelijk afval, maar voor recyclage moeten worden ingeleverd. Zodra het product het einde van de levensduur heeft bereikt, dient u het naar een inzamelpunt te brengen dat hiertoe werd aangeduid door uw plaatselijke autoriteiten, sommige autoriteiten accepteren producten zonder dat u hiervoor dient te betalen. Door het product en de verpakking op deze manier te recyclen helpt u het milieu en de gezondheid van de mens te beschermen.

D-Link en het milieu

Bij D-Link spannen we ons in om de impact van onze handelingen en producten op het milieu te beperken. Om deze impact te beperken, ontwerpt en bouwt D-Link zijn producten zo milieuvriendelijk mogelijk, door het gebruik van recycleerbare producten met lage toxiciteit in product en verpakking.

D-Link raadt aan om steeds uw D-Link producten uit te schakelen of uit de stekker te halen wanneer u ze niet gebruikt. Door dit te doen bespaart u energie en beperkt u de CO₂-emissies.

Breng een bezoek aan www.dlinkgreen.com voor meer informatie over onze milieuverantwoorde producten en verpakkingen.

POLSKI**PL**

Ten symbol umieszczony na produkcie lub opakowaniu oznacza, że zgodnie z miejscowym prawem i lokalnymi przepisami niniejszego produktu nie wolno wyrzucać jak odpady czy śmieci z gospodarstwa domowego, lecz należy go poddać procesowi recyklingu. Po zakończeniu użytkowania produktu, niektóre odpowiednie do tego celu podmioty przyjmą takie produkty nieodpłatnie, dlatego prosimy dostarczyć go do punktu zbiórki wskazanego przez lokalne władze. Poprzez proces recyklingu i dzięki takiemu postępowaniu z produktem oraz jego opakowaniem, pomogą Państwo chronić środowisko naturalne i dbać o ludzkie zdrowie.

D-Link i środowisko

D-Link podchodzimy w sposób świadomy do ochrony otoczenia oraz jesteśmy zaangażowani w zmniejszanie wpływu naszych działań i produktów na środowisko naturalne. W celu zminimalizowania takiego wpływu firma D-Link konstruuje i wytwarza swoje produkty w taki sposób, aby były one jak najbardziej przyjazne środowisku, stosując do tych celów materiały nadające się do powtórnego wykorzystania, charakteryzujące się małą toksycznością zarówno w przypadku samych produktów jak i opakowań.

Firma D-Link zaleca, aby Państwo zawsze prawidłowo wyłączali z użytku swoje produkty D-Link, gdy nie są one wykorzystywane. Postępując w ten sposób pozwalają Państwo oszczędzać energię i zmniejszać emisje CO₂.

Aby dowiedzieć się więcej na temat produktów i opakowań mających wpływ na środowisko prosimy zapoznać się ze stroną Internetową www.dlinkgreen.com.

ČESKY**CZ**

Tento symbol na výrobku nebo jeho obalu znamená, že podle místně platných předpisů se výrobek nesmí vyhazovat do komunálního odpadu, ale odeslat k recyklaci. Až výrobek doslouží, odneste jej prosím na sběrné místo určené místními úřady k tomuto účelu. Někteřá sběrná místa přijímají výrobky zdarma. Recyklací výrobku i obalu pomáháte chránit životní prostředí i lidské zdraví.

D-Link a životní prostředí

Ve společnosti D-Link jsme si vědomi vlivu našich provozů a výrobků na životní prostředí a snažíme se o minimalizaci těchto vlivů. Proto své výrobky navrhujeme a vyrábíme tak, aby byly co nejekologičtější, a ve výrobcích i obalech používáme recyklovatelné a nízkotoxické materiály.

Společnost D-Link doporučuje, abyste své výrobky značky D-Link vypnuli nebo vytáhli ze zásuvky vždy, když je nepoužíváte. Pomůžete tak šetřit energii a snížit emise CO₂.

Více informací o našich ekologických výrobcích a obalech najdete na adrese www.dlinkgreen.com.

MAGYAR**HU**

Ez a szimbólum a terméken vagy a csomagoláson azt jelenti, hogy a helyi törvényeknek és szabályoknak megfelelően ez a termék nem semmisíthető meg a háztartási hulladékkal együtt, hanem újrahasznosításra kell küldeni. Kérjük, hogy a termék élettartamának elteltét követően vigye azt a helyi hatóság által kijelölt gyűjtőhelyre. A termékek egyes helyeken ingyen elhelyezhetők. A termék és a csomagolás újrahasznosításával segíti védeni a környezetet és az emberek egészségét.

A D-Link és a környezet

A D-Linknél megértjük és elköteleztük magunkat a műveleteink és termékeink környezetre gyakorolt hatásainak csökkentésére. Az ezen hatás csökkentése érdekében a D-Link a lehető leginkább környezetbarát termékeket tervez és gyárt azáltal, hogy újrahasznosítható, alacsony károsanyag-tartalmú termékeket gyárt és csomagolásokat alkalmaz.

A D-Link azt javasolja, hogy mindig kapcsolja ki vagy húzza ki a D-Link termékeket a tápforrásból, ha nem használja azokat. Ezzel segít az energia megtakarításában és a széndioxid kibocsátásának csökkentésében.

Környezetbarát termékeinkről és csomagolásainkról további információkat a www.dlinkgreen.com weboldalon tudhat meg.

NORSK**NO**

Dette symbolet på produktet eller forpakningen betyr at dette produktet ifølge lokale lover og forskrifter ikke skal kastes sammen med husholdningsavfall, men leveres inn til gjenvinning. Vennligst ta det til et innsamlingssted anvist av lokale myndigheter når det er kommet til slutten av levetiden. Noen steder aksepteres produkter uten avgift. Ved på denne måten å gjenvinne produktet og forpakningen hjelper du å verne miljøet og beskytte folks helse.

D-Link og miljøet

Hos D-Link forstår vi oss på og er forpliktet til å minske innvirkningen som vår drift og våre produkter kan ha på miljøet. For å minimalisere denne innvirkningen designer og lager D-Link produkter som er så miljøvennlig som mulig, ved å bruke resirkulerbare, lav-toksiske materialer både i produktene og forpakningen.

D-Link anbefaler at du alltid slår av eller frakobler D-Link-produkter når de ikke er i bruk. Ved å gjøre dette hjelper du å spare energi og å redusere CO2-utslipp.

For mer informasjon angående våre miljøansvarlige produkter og forpakninger kan du gå til www.dlinkgreen.com.

DANSK**DK**

Dette symbol på produktet eller emballagen betyder, at dette produkt i henhold til lokale love og regler ikke må bortskaffes som husholdningsaffald, mens skal sendes til genbrug. Indlever produktet til et indsamlingssted som angivet af de lokale myndigheder, når det er nået til slutningen af dets levetid. I nogle tilfælde vil produktet blive modtaget gratis. Ved at indlevere produktet og dets emballage til genbrug på denne måde bidrager du til at beskytte miljøet og den menneskelige sundhed.

D-Link og miljøet

Hos D-Link forstår vi og bestræber os på at reducere enhver indvirkning, som vores aktiviteter og produkter kan have på miljøet. For at minimere denne indvirkning designer og producerer D-Link sine produkter, så de er så miljøvenlige som muligt, ved at bruge genanvendelige materialer med lavt giftighedsniveau i både produkter og emballage.

D-Link anbefaler, at du altid slukker eller frakobler dine D-Link-produkter, når de ikke er i brug. Ved at gøre det bidrager du til at spare energi og reducere CO₂-udledningerne.

Du kan finde flere oplysninger om vores miljømæssigt ansvarlige produkter og emballage på www.dlinkgreen.com.

SUOMI**FI**

Tämä symboli tuotteen pakkauksessa tarkoittaa, että paikallisten lakien ja säännösten mukaisesti tätä tuotetta ei pidä hävittää yleisen kotitalousjätteen seassa vaan se tulee toimittaa kierrätettäväksi. Kun tuote on elinkaarensa päässä, toimita se lähimpään viranomaisten hyväksymään kierrätyspisteeseen. Kierrättämällä käytetyn tuotteen ja sen pakkauksen autat tukemaan sekä ympäristön että ihmisten terveyttä ja hyvinvointia.

D-Link ja ympäristö

D-Link ymmärtää ympäristönsuojelun tärkeyden ja on sitoutunut vähentämään tuotteistaan ja niiden valmistuksesta ympäristölle mahdollisesti aiheutuvia haittavaikutuksia. Nämä negatiiviset vaikutukset minimoidakseen D-Link suunnittelee ja valmistaa tuotteensa mahdollisimman ympäristöystävällisiksi käyttämällä kierrätettäviä, alhaisia pitoisuuksia haitallisia aineita sisältäviä materiaaleja sekä tuotteissaan että niiden pakkauksissa.

Suosittelomme, että irrotat D-Link-tuotteesi virtalähteestä tai sammutat ne aina, kun ne eivät ole käytössä. Toimimalla näin autat säästämään energiaa ja vähentämään hiilidioksiidipäästöjä.

Lue lisää ympäristöystävällisistä D-Link-tuotteista ja pakkauksistamme osoitteesta www.dlinkgreen.com.

SVENSKA**SE**

Den här symbolen på produkten eller förpackningen betyder att produkten enligt lokala lagar och föreskrifter inte skall kastas i hushållssoporna utan i stället återvinnas. Ta den vid slutet av dess livslängd till en av din lokala myndighet utsedd uppsamlingsplats, vissa accepterar produkter utan kostnad. Genom att på detta sätt återvinna produkten och förpackningen hjälper du till att bevara miljön och skydda människors hälsa.

D-Link och miljön

På D-Link förstår vi och är fast beslutna att minska den påverkan våra verksamheter och produkter kan ha på miljön. För att minska denna påverkan utformar och bygger D-Link sina produkter för att de ska vara så miljövänliga som möjligt, genom att använda återvinningsbara material med låg gifthalt i både produkter och förpackningar.

D-Link rekommenderar att du alltid stänger av eller kopplar ur dina D-Link produkter när du inte använder dem. Genom att göra detta hjälper du till att spara energi och minska utsläpp av koldioxid.

För mer information om våra miljöansvariga produkter och förpackningar www.dlinkgreen.com.

PORTUGUÊS**PT**

Este símbolo no produto ou embalagem significa que, de acordo com as leis e regulamentações locais, este produto não deverá ser eliminado juntamente com o lixo doméstico mas enviado para a reciclagem. Transporte-o para um ponto de recolha designado pelas suas autoridades locais quando este tiver atingido o fim da sua vida útil, alguns destes pontos aceitam produtos gratuitamente. Ao reciclar o produto e respectiva embalagem desta forma, ajuda a preservar o ambiente e protege a saúde humana.

A D-Link e o ambiente

Na D-Link compreendemos e comprometemo-nos com a redução do impacto que as nossas operações e produtos possam ter no ambiente. Para minimizar este impacto a D-Link concebe e constrói os seus produtos para que estes sejam o mais inofensivos para o ambiente possível, utilizando materiais recicláveis e não tóxicos tanto nos produtos como nas embalagens.

A D-Link recomenda que desligue os seus produtos D-Link quando estes não se encontrarem em utilização. Com esta acção ajudará a poupar energia e reduzir as emissões de CO₂.

Para saber mais sobre os nossos produtos e embalagens responsáveis a nível ambiental visite www.dlinkgreen.com.