

# Convert Digital Signage into Interactive Display

## KT-T Series

Existing displays can be transformed into interactive boards with minimal effort. The touch overlay KT-T series is a touch screen that easily attaches to standard digital signages. This interactivity will enhance user engagement in your locations, be they schools, companies, shops, etc.

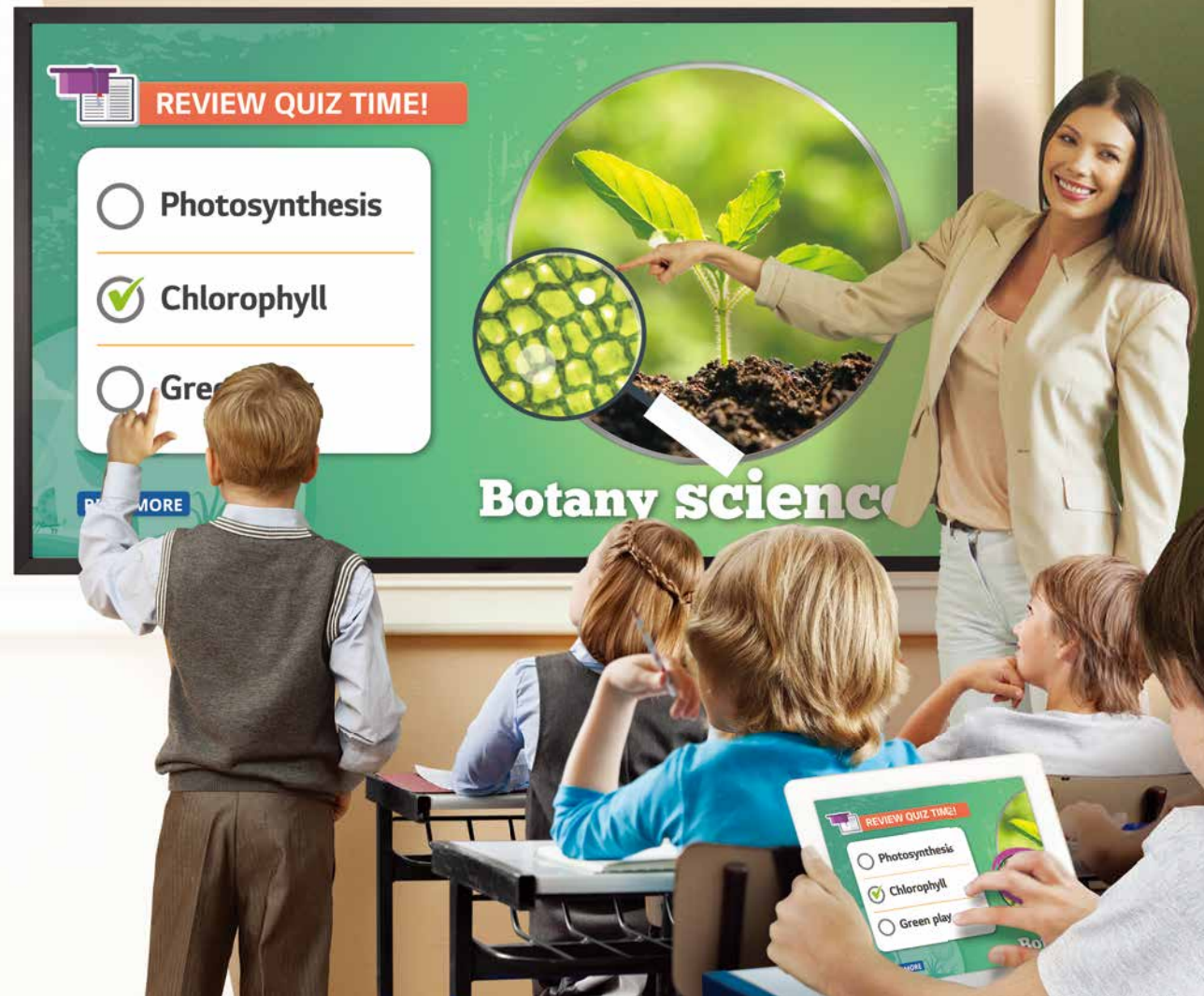

# Convert Digital Signage into Interactive Display

## KT-T Series

### Interactive Performance

#### Clean Touch Experience

LG proprietary touch technology can draw clean and accurate diagonal lines through controlling multi-touch gestures in great precision. Clean multi-touch experience with IR Spread is based on our in-house IR-Spread technology which provides better accuracy compared to conventional IR Matrix.



#### Multi Touch Experience

It provides a more realistic sense of touch since it can recognize up to 10 point-touches at once. Various touch-based customer services can be provided through the screen so that consumers will have unforgettable shopping experiences.



# Convert Digital Signage into Interactive Display

## KT-T Series

### User Convenience

#### Slim Design for a Sleek Look

With slim bezel and depth, KT-T series is designed to fit compatible displays and provide better touch accuracy. This way, the display maintains its sleek and clean look even when multi-functions are added on.

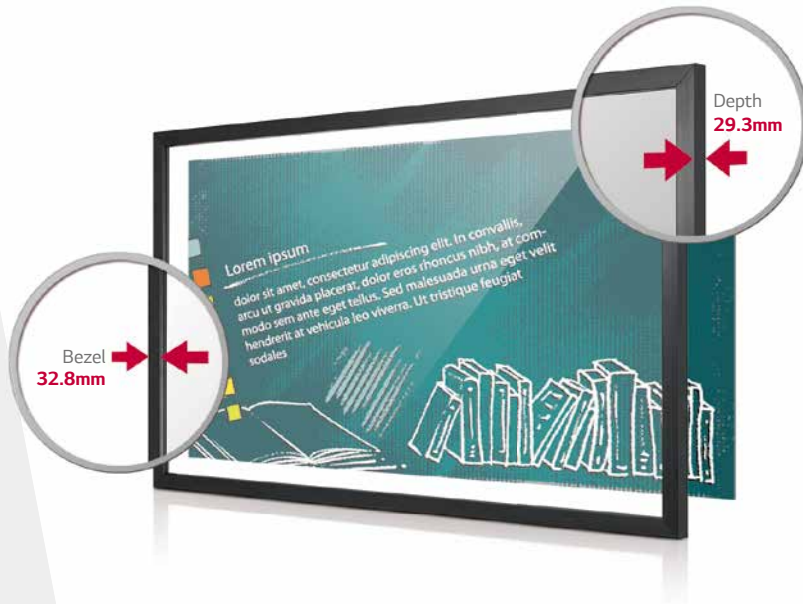

#### Simple Installation

Just a few screws and brackets are needed to attach a touch overlay kit to the display. With low cost and minimal effort, your display can have the added value of touch performance.



# Convert Digital Signage into Interactive Display

## KT-T Series

### Application

By adding touch values to standard displays, the utilization possibilities expand to a surprising variety of places. Wherever the KT-T series is installed, its two-way communication maximizes user engagement as well as user convenience.



## Dimension (Unit: mm)

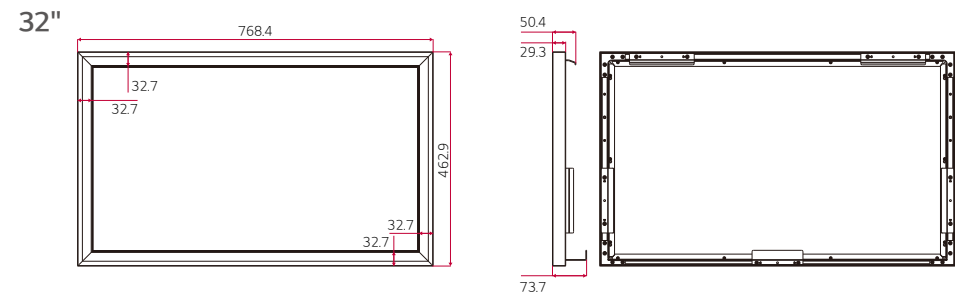
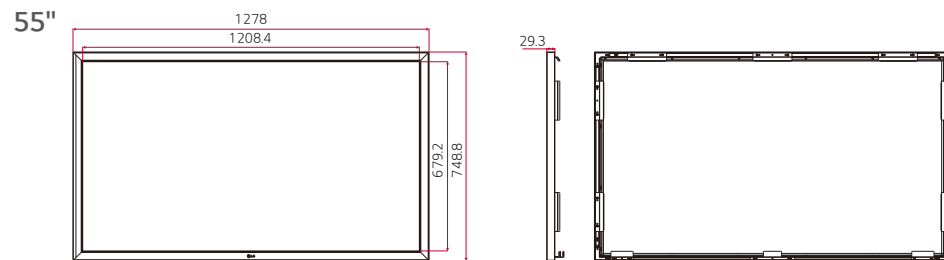
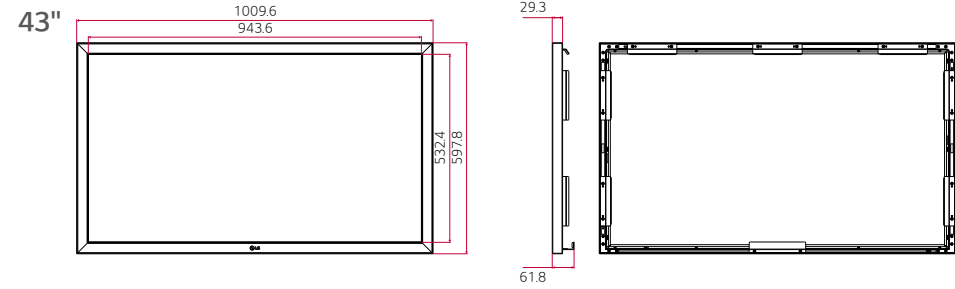
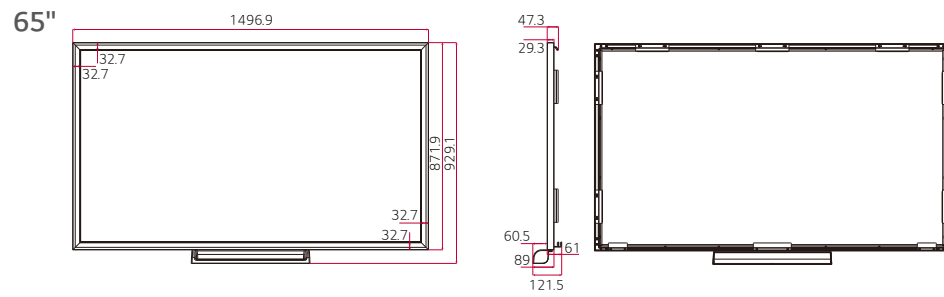
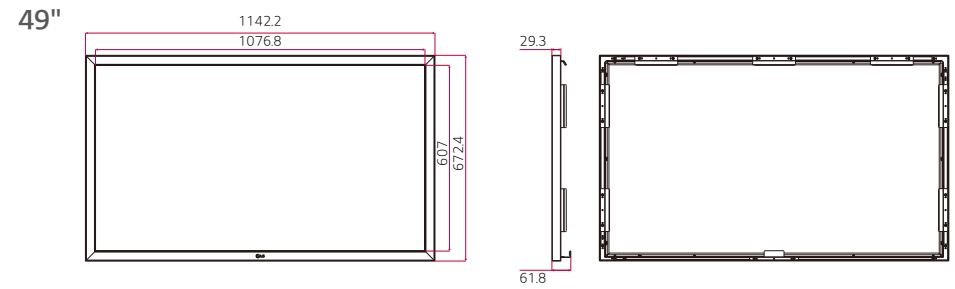
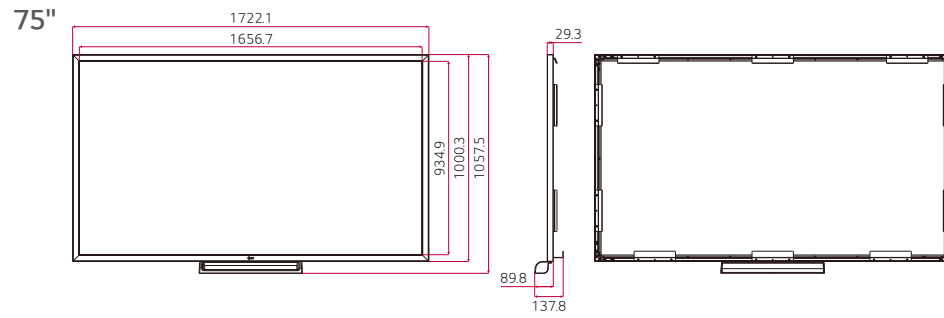

# Specifications

	KT-T75E	KT-T65E	KT-T55E	KT-T49E	KT-T43E	KT-T32E	
TOUCH	Touch Type	IR (Infrared Rays) Spread	IR (Infrared Rays) Spread	IR (Infrared Rays) Spread	IR (Infrared Rays) Spread	IR (Infrared Rays) Spread	
	Available Object Size for Touch	Ø8 mm	Ø8 mm	Ø8 mm	Ø8 mm	Ø8 mm	
	Scan Time	10 ms (1 point) - 30 ms (10 points)	10 ms (1 point) - 30 ms (10 points)	9 ms (1 point) - 15 ms (10 points)	9 ms (1 point) - 15 ms (10 points)	9 ms (1 point) - 15 ms (10 points)	9 ms (1 point) - 15 ms (10 points)
	Accuracy	1 mm	1 mm	1 mm	1 mm	1 mm	
	Interface	USB 2.0	USB 2.0	USB 2.0	USB 2.0	USB 2.0	
	Protection Glass Thickness	3.2T (Anti-Glare)	2.8T (Anti-Glare)	2.8T (Anti-Glare)	2.8T (Anti-Glare)	2.8T (Anti-Glare)	2.8T (Anti-Glare)
	Protection Glass Transmission	85 ± 5%	85 ± 5%	85 ± 5%	85 ± 5%	85 ± 5%	85 ± 5%
	Operating System Support	Windows 7, Windows 8, Windows 8.1, Windows 10 / Mac OSX (10.7 or later) / Android					
	Multi Touch Point	Max 10 Points	Max 10 Points	Max 10 Points	Max 10 Points	Max 10 Points	Max 10 Points
	Touch Resolution	1,428 × 803	1,428 × 803	1,428 × 803	1,428 × 803	1,428 × 803	1,428 × 803
PANEL	Screen Size	75"	65"	55"	49"	43"	32"
	Compatible Products	75UH5C, 75UM3C	65SM5(K)D/E, 65SE3(K)D/E	55SH7(P)E, 55SH7DD, 55SM5(K)D/E, 55SM3C, 55SE3(K)D/E, 55SE3DD, 55SL5B	49SH7(P)E, 49SH7DD, 49SM5(K)D/E, 49SM3C, 49SE3(K)D/E, 49SE3DD, 49SL5B	43SH7(P)E, 43SH7DD, 43SM5(K)D/E, 43SM3C, 43SE3(K)D/E, 43SE3DD, 43SL5B	32SM5(K)D/E, 32SE3(K)D/E
	Brightness	N/A (Max 20% Brightness Reduction with Protection Glass)					
	Orientation	Landscape & Portrait	Landscape & Portrait	Landscape & Portrait	Landscape & Portrait	Landscape & Portrait	Landscape & Portrait
CONNECTIVITY	Input	USB	USB	USB	USB	USB	
PHYSICAL SPECIFICATION	Color	Black	Black	Black	Black	Black	Black
	Bezel Width	32.7 mm	32.7 mm	32.7 mm	32.7 mm	32.7 mm	32.7 mm
	Overlay Dimension (W × H × D)	1,722.1 × 1,000.3 × 29.3 mm	1,496.9 × 871.9 × 29.3 mm	1,278.0 × 748.8 × 29.3 mm	1,142.2 × 672.4 × 29.3 mm	1,009.6 × 597.8 × 29.3 mm	768.4 × 462.9 × 29.3 mm
	Weight (Head)	17 kg	12.9 kg	10.2 kg	7.8 kg	6.4 kg	4.2 kg
	Carton Dimensions (W × H × D)	1,901.0 × 1,171.0 × 190.0 mm	1,676.0 × 1,042.0 × 190.0 mm	1,386.0 × 869.0 × 162.0 mm	1,250.0 × 792.0 × 162.0 mm	1,170.0 × 710.0 × 152.0 mm	866.0 × 575.0 × 152.0 mm
	Packed Weight	27.2 kg	21.3 kg	13.5 kg	12.7 kg	9.9 kg	7 kg
SPECIAL FEATURES	Language (Manual)	English, Spanish, Korean, Franch	English, Spanish, Korean, Franch	English, Spanish, Korean, Franch	English, Spanish, Korean, Franch	English, Spanish, Korean, Franch	English, Spanish, Korean, Franch
ENVIRONMENT CONDITIONS	Operation Temperature	0°C to 40°C	0°C to 40°C	0°C to 40°C	0°C to 40°C	0°C to 40°C	0°C to 40°C
	Operation Humidity	10% to 85%	10% to 85%	10% to 80%	10% to 80%	10% to 80%	10% to 80%
POWER	Power Supply	USB	USB	USB	USB	USB	USB
	Typ.	Max 1.8 W	1.8 W	1.31 W	1.31 W	1.31 W	1.31 W
ACCESSORIES		Overlay Manual (CD), Pen (2), Pen Tray, Install Accessories	Overlay Manual (CD), Pen (2), Pen Tray, Install Accessories	Manual (Overlay), Install Accessorie	Overlay Manual (CD), Install Accessories	Overlay Manual (CD), Install Accessories	Overlay Manual (CD), Install Accessories

Download LG Commercial Display Mobile App



- [www.lg.com/b2b](http://www.lg.com/b2b)
- [youtube.com/c/LGCommercialDisplay](https://www.youtube.com/c/LGCommercialDisplay)
- <https://www.facebook.com/LGInformationDisplay/>
- <https://www.linkedin.com/company-beta/16235211/>

LG may make changes to specifications and product descriptions without notice.  
 Copyright © 2018 LG Electronics Inc. All rights reserved. "LG Life's Good" is a registered trademark of LG Corp.  
 The names of products and brands mentioned here may be the trademarks of their respective owners.

