



PEDESTAL MOUNTS

SUPER STRONG MOUNTING SOLUTIONS
FOR INSTALLATION OF HEAVIER DEVICES



PEDESTAL MOUNTS

3	PEDESTAL MOUNTS WITH WINGNUTS
4	PEDESTAL MOUNTS WITH MOUNTING PLATE
5	PEDESTAL MOUNTS WITH TOP
6	SMALL PEDESTAL MOUNTS WITH SWIVELING TOP
6	ADJUSTABLE TABLET HOLDERS
7	PEDESTAL MOUNTS FOR CABLE ENTRY
8	EXTRA STRONG PIPE MOUNTS
8	STRONG PIPE MOUNTS
9	STANDARD PIPE MOUNTS
10	FORK LIFT MOUNTS
11	U-MOUNTS
12	HEAVY DUTY SUCTION CUP MOUNTS
13	MULTIMOVECLIP
14	EXTENSION PARTS WITH SMALL TEETH
15	EXTENSION PARTS WITH LARGE TEETH
16	MOUNTING/BASE PLATES & TOPS
17	VIBRATION DAMPERS
17	WINGNUTS & SCREWS
17	VESA MOUNTING PLATES
18	EXTENSION PARTS & PLATES FOR CABLE ENTRY
19	TOPS & BASE/FOOT FOR CABLE ENTRY



PRODUCT IS COMPATIBLE WITH SQUARE BASE/TOP



PRODUCT IS COMPATIBLE WITH ROUND BASE/TOP



PRODUCT IS COMPATIBLE WITH CABLE ENTRY



PRODUCT IS COMPATIBLE WITH MOUNTS WITH SMALL TEETH



PRODUCT IS COMPATIBLE WITH MOUNTS WITH LARGE TEETH



PRODUCT HAS A SWIVELING FEATURE



PRODUCT IS EQUIPPED WITH WINGNUT



PEDESTAL MOUNTS WITH WINGNUTS

- A versatile pedestal mount with wingnuts which allow for easy adjustment
- The joints can be angled in many steps, thanks to the small interlocking teeth
- Small interlocking teeth, makes angles of 0-180° (16 positions in steps of 11,25°)
- Square top, 50x50 mm, dual AMPS holes
- Rod diameter 30 mm
- Round base/top, diameter 64 mm, multiple AMPS holes, radial adjustment



**WITH WINGNUTS
FOR EASY ADJUSTMENT!**



PEDESTAL MOUNT WITH WINGNUTS, ROUND BASE & SQUARE TOP

<i>Item no.</i>	<i>Product</i>	<i>Total height</i>
215836	Pedestal Mount 2"	Round base, square top 62 mm
215837	Pedestal Mount 4"	Round base, square top 114 mm
215838	Pedestal Mount 6"	Round base, square top 164 mm
215937	Pedestal Mount 8"	Round base, square top 214 mm



PEDESTAL MOUNT WITH WINGNUTS, ROUND BASE & TOP

<i>Item no.</i>	<i>Product</i>	<i>Total height</i>
215839	Pedestal Mount 2"	Round base, round top 62 mm
215840	Pedestal Mount 4"	Round base, round top 114 mm
215863	Pedestal Mount 6"	Round base, round top 164 mm
215864	Pedestal Mount 8"	Round base, round top 214 mm
215865	Pedestal Mount 10"	Round base, round top 264 mm





PEDESTAL MOUNTS WITH MOUNTING PLATE

- Set the pedestal mount into desired angles
- The joints are super strong, thanks to the large interlocking teeth
- Large interlocking teeth, makes angles of 0-195° (8 positions in steps of 24°)
- Square base/top, 50x50 mm, dual AMPS holes
- Rod diameter 30 mm
- Round base/top, diameter 64 mm, multiple AMPS holes, radial adjustment



PEDESTAL MOUNT WITH SQUARE BASE & TOP

<i>Item no.</i>	<i>Product</i>	<i>Total height</i>
215532	Pedestal Mount 2"	62 mm
215525	Pedestal Mount 4"	114 mm
215526	Pedestal Mount 6"	164 mm
215533	Pedestal Mount 8"	214 mm
215550	Pedestal Mount 10"	264 mm



SUPER STRONG!



PEDESTAL MOUNT WITH ROUND BASE & TOP

<i>Item no.</i>	<i>Product</i>	<i>Total height</i>
215786	Pedestal Mount 2"	62 mm
215787	Pedestal Mount 4"	114 mm
215788	Pedestal Mount 6"	164 mm
215789	Pedestal Mount 8"	214 mm
215790	Pedestal Mount 10"	264 mm





PEDESTAL MOUNTS WITH TOP



SWIVELING PEDESTAL MOUNT

- Top part of the mount swivels 300°
- For installation of two devices back to back
- Mounting surfaces are angled 10° and 20°
- With MultiMoveClip, fits for all Brodit holders with tilt swivel
- Round base mounting plate, diameter 100 mm, thickness 9 mm, 6 holes
- Rod diameter 30 mm

<i>Item no.</i>	<i>Product</i>	<i>Total height</i>
215523	Swiveling Pedestal Mount 6"	262 mm



PEDESTAL MOUNT 4" WITH MULTIMOVECLIP

- With MultiMoveClip, fits for all Brodit holders with tilt swivel
- Round base mounting plate, diameter 100 mm, thickness 9 mm, 6 holes
- Rod diameter 30 mm

<i>Item no.</i>	<i>Product</i>	<i>Total height</i>
215518	Pedestal Mount with MultiMoveClip"	138 mm



PEDESTAL MOUNT 4" WITH BASE PLATE

- Square mounting plate, 50x50 mm, dual AMPS holes
- Round base mounting plate, diameter 100 mm, thickness 9 mm, 6 holes
- Rod diameter 30 mm

<i>Item no.</i>	<i>Product</i>	<i>Total height</i>
215563	Pedestal Mount 4"	124 mm





ca 345°

SWIVELS!

SMALL PEDESTAL MOUNTS WITH SWIVELING TOP

- A light weight, smaller size Pedestal Mount perfect for use in cramped places
- Smaller top compared to standard Pedestal Mounts, rod diameter 30 mm
- Height 117 mm + top
- Swiveling top turns approximately 345°
- Dual AMPS holes

LIGHT WEIGHT & SMALLER SIZE!

<i>Item no.</i>	<i>Product</i>	<i>Top angle</i>
215815	Swiveling Pedestal Mount	15° angled top
215816	Swiveling Pedestal Mount	30° angled top
215817	Swiveling Pedestal Mount	45° angled top
215818	Swiveling Pedestal Mount	60° angled top
215819	Swiveling Pedestal Mount	75° angled top
215820	Swiveling Pedestal Mount	90° angled top



ADJUSTABLE TABLET HOLDERS

- Adjustable tablet holder for use with devices with or without a skin/case
- Easy to place/remove device in holder
- The holder is equipped with a tilt swivel, tilts 20° and swivels 360°
- Add a MultiMoveClip for easy attachment/removal on a Pedestal Mount (only included with the sets listed below, not included with the adjustable tablet holder)
- Measure the height and thickness of your device with/without skin/case and compare with list below

ADJUSTABLE TABLET HOLDERS

<i>Item no.</i>	<i>Device height</i>	<i>Device thickness</i>
511848	120-150 mm	max 25 mm
511849	140-195 mm	max 25 mm
511850	180-230 mm	max 25 mm
511971	120-150 mm	max 30 mm
511972	140-195 mm	max 30 mm
511973	180-230 mm	max 30 mm

HOLDER FOR TABLETS WITH/WITHOUT CASE/SKIN



SET: ADJUSTABLE TABLET HOLDER & SMALL PEDESTAL MOUNT 45°

<i>Item no.</i>	<i>Device height</i>	<i>Device thickness</i>
215855	120-150 mm	max 25 mm
215856	140-195 mm	max 25 mm
215857	180-230 mm	max 25 mm





PEDESTAL MOUNTS FOR CABLE ENTRY

- Hollow Pedestal Mounts for cable entry
- For use on store counter tops, events , fairs etc.
- Available with a fixed top and a swiveling top
- Swiveling top turns approximately 345°
- Rod diameter 35 mm, hole inside diameter 25 mm
- With MultiMoveClip, fits for all Brodit holders with tilt swivel

FOR CABLE ENTRY!



PEDESTAL MOUNTS FOR CABLE ENTRY, WITH SWIVELING TOP

Top angle	15°	30°	45°	60°	75°	90°
Height 4,5" + top	215629	215630	215631	215632	215633	215634
Height 6,5" + top	215635	215636	215637	215638	215639	215640
Height 8,5" + top	215641	215642	215643	215644	215645	215646



PEDESTAL MOUNTS FOR CABLE ENTRY, WITH FIXED TOP

Top angle	15°	30°	45°	60°	75°	90°
Height 4" + top	215611	215612	215613	215614	215615	215616
Height 6" + top	215617	215618	215619	215620	215621	215622
Height 8" + top	215623	215624	215625	215626	215627	215628





EXTRA STRONG PIPE MOUNTS

- A pipe mount for round bars. Perfect for installations in heavy duty vehicles or where road conditions are rough
- For use on motorcycles, boats, carts, stands, wheelchairs, airplanes etc
- Provides a very sturdy mounting platform for tablets, rugged PDAs, smartphones, monitors etc
- Mounting plate 69x75 mm with multiple AMPS holes (M4x12 screws)



<i>Item no.</i>	<i>Product</i>	<i>Diameter</i>
215935	Pipe mount	Fits diameter 25 mm (40 mm if insert removed)
215858	Pipe mount	Fits diameter 30 mm (40 mm if insert removed)
215859	Pipe mount	Fits diameter 35 mm (40 mm if insert removed)
215860	Pipe mount	Fits diameter 40 mm



**EXTRA STRONG
PIPE MOUNT!**

STRONG PIPE MOUNTS

- The BarGrip is a pipe mount for round pipes/bars
- Easy to install, a very tight fit
- Available with fixed mounting plate or an adjustable tilting arm
- Mounting plate 50x42 mm
- Made of plastic



BARGRIP

- Fits for round pipes/bars 22-31 mm

<i>Item no.</i>	<i>Product</i>
215792	Swiveling mounting plate, tilts 210°, rotates 360°
215793	Fixed mounting plate, AMPS holes
215794	Fixed mounting plate, 4 holes for nut + bolt

BARGRIP XL

- Fits for round pipes/bars 31-50 mm

<i>Item no.</i>	<i>Product</i>
215944	Swiveling mounting plate, tilts 210°, rotates 360°
215945	Fixed mounting plate, AMPS holes
215946	Fixed mounting plate, 4 holes for nut + bolt





STANDARD PIPE MOUNTS

- For installation of devices on pipes and rods/bars
- For use on most types of vehicles, motorcycles, boats, carts, stands, wheelchairs, airplanes etc
- Item no 215664-215667 are made of ABS/Acetal plastic, Item no. 215938+215966 are made of aluminum

**MOUNT ON
ROUND OBJECTS!**



Item no. 215664



Item no. 215666



Item no. 215938



Item no. 215966

<i>Item no.</i>	<i>Product</i>	<i>Fits pipe diameter</i>	<i>Predrilled holes</i>
215664	Pipe mount, Mounting plate 50x42 mm	19-30 mm	AMPS holes
215665	Pipe mount, Mounting plate 160x50 mm	19-30 mm	6 holes
215666	Pipe mount, Mounting plate angled 45°	19-30 mm	6 holes
215667	Pipe mount, Mounting plate angled 90°	19-30 mm	6 holes
215938	Pipe mount, Mounting plate 55x42 mm	19-30 mm	Dual AMPS holes
215966	Dual pipe mount with MultiMoveClip	20 mm	





FORK LIFT MOUNTS

- For installation onto square objects, such as the rollbar of a forklift
- Fits square rods/bars 5-130 mm

**MOUNT ON
SQUARE OBJECTS!**



FORKLIFT MOUNT, AMPS

- With multiple AMPS holes
- Width between rods 87 mm

Item no. *Product*

215677 Fork lift Mount, multiple AMPS holes



FORKLIFT MOUNT WITH PEDESTAL MOUNT FOOT

- Large interlocking teeth Pedestal Mount foot
- Width between rods 36 mm

Item no. *Product*

215784 Fork lift Mount, integrated top/base





U-MOUNTS

- For installation onto square objects, such as the rollbar of a fork lift or a square pillar in a ware house
- Fits rods/bars 35-40 mm or 45-50 mm
- Dual AMPS holes

**MOUNT ON
SQUARE OBJECTS!**



<i>Item no.</i>	<i>Product</i>
215709	U-Mount. Fits bars 45-50 mm wide
215710	U-Mount. Fits bars 35-40 mm wide





HEAVY DUTY SUCTION CUP MOUNTS

- Extra strong, heavy duty suction cup mounts
- Provides a firm installation on flat surfaces such as glass or metal
- Dual AMPS holes

**EXTRA STRONG
SUCTION CUP!**



Item no. 215712



Item no. 215675



Item no. 215854

<i>Item no.</i>	<i>Product</i>
215712	Single Suction Cup Mount
215671	Dual Suction Cup Mount
215675	Triple Suction Cup Mount
215854	Dual Suction Cup Mount with Pedestal Mount 8"
215676	Wingnut + distance plate
215679	Distance plate, 5 pcs



215676



215679





MULTIMOVECLIP

- An adapter system for easy attachment and removal of a holder onto a mount
- Allows you to easily switch holders without changing the mount
- Move the holder between vehicle-warehouse-office
- Compatible with all Brodit holders with tilt swivel
- AMPS holes

SWITCH DEVICE IN SECONDS!



<i>Item no.</i>	<i>Product</i>
215699	MultiMoveClip, high strength easy open
215538	MultiMoveClip, high strength
215668	MultiMoveClip
215718	MultiMoveClip, high strength easy open high
215822	MultiMoveClip, high strength easy open high, with lock + 2 keys
215591	Screw set. 4 screws + 4 nuts + 1 torx key. Color: Black (for installing a MultiMoveClip onto a Pedestal Mount)
216591	Screw set. 4 screws + 4 nuts + 1 torx key. Color: Silver (for installing a MultiMoveClip onto a Pedestal Mount)
215527	Adapter plate, for holders without tilt swivel on MultiMoveClip

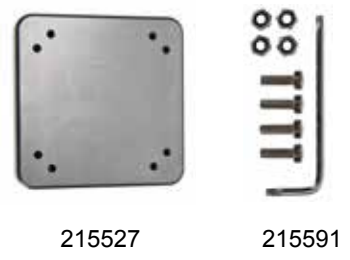

EXTENSION PARTS WITH SMALL TEETH



- Create your own unique solution by combining various Pedestal Mount parts
- The joints can be angled in many steps, thanks to the small interlocking teeth
- Small interlocking teeth, makes angles of 0-180° (16 positions in steps of 11,25°)
- Rod diameter 30 mm
- NOTE: Each part is marked 1 or 2. In order to make a straight design (angle 0°), you need to match a "part 1" with a "part 2". If you mount "part 1" onto "part 1", or "part 2" onto "part 2", it will not be possible to create a straight (angle 0°) design, but the parts will still be compatible. (Only applies for the Pedestal Mounts with small interlocking teeth.)

WITH SMALL TEETH



Item no. 215846



Item no. 215767

<i>Item no.</i>	<i>Product</i>	<i>Total length</i>	<i>Inner length</i>	<i>CC-dimension</i>
215766	Extension part 2"	82 mm	14 mm	52 mm
215846	Extension part 4"	132 mm	64 mm	102 mm
215762	Extension part 6"	182 mm	114 mm	152 mm
215847	Extension part 8"	232 mm	164 mm	202 mm
215767	Extension part 2", 90° angle	82 mm	14 mm	52 mm



Item no. 215850



Item no. 215849

<i>Item no.</i>	<i>Product</i>	<i>Total length</i>	<i>CC-dimension</i>
215850	Base/top, square mounting plate 50x50 mm ("part 2") Dual AMPS holes	46 mm	31 mm



<i>Item no.</i>	<i>Product</i>	<i>Total length</i>	<i>CC-dimension</i>
215849	Base/top, round mounting plate 64 mm diameter ("part 1") Multiple AMPS holes, radial adjustment	46 mm	31 mm
215768	Base/top, round mounting plate 64 mm diameter ("part 2") Multiple AMPS holes, radial adjustment	46 mm	31 mm

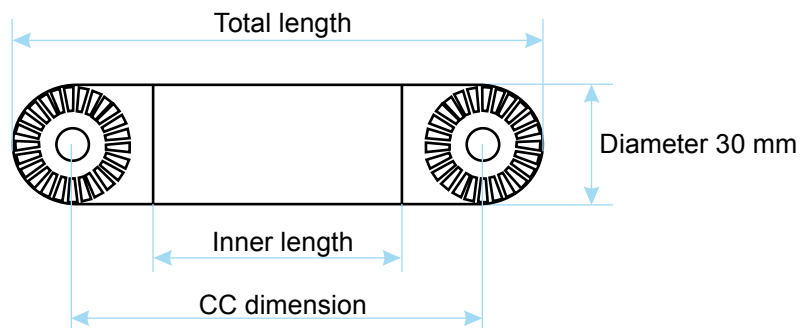

EXTENSION PARTS WITH LARGE TEETH



- Create your own unique solution by combining various Pedestal Mount parts
- The joints are super strong, thanks to the large interlocking teeth
- Large interlocking teeth, makes angles of 0-195° (8 positions in steps of 24°)
- Rod diameter 30 mm



Item no. 215514

WITH LARGE TEETH



Item no. 215724



Item no. 215674

<i>Item no.</i>	<i>Product</i>	<i>Total length</i>	<i>Inner length</i>	<i>CC-dimension</i>
215515	Extension part 2"	82 mm	14 mm	52 mm
215514	Extension part 4"	132 mm	64 mm	102 mm
215534	Extension part 6"	182 mm	114 mm	152 mm
215549	Extension part 8"	232 mm	164 mm	202 mm
215724	Extension part 2", 90° angle	82 mm	14 mm	52 mm
215674	Extension Part 4", rotatable	132 mm	64 mm	102 mm



Item no. 215516



Item no. 215785

<i>Item no.</i>	<i>Product</i>	<i>Total length</i>	<i>CC-to surface</i>
215516	Base/top, square mounting plate 50x50 mm Dual AMPS holes	46 mm	31 mm



<i>Item no.</i>	<i>Product</i>	<i>Total length</i>	<i>CC-to surface</i>
215785	Base/top, round mounting plate 46 mm diameter Multiple AMPS holes, radial adjustment	46 mm	31 mm

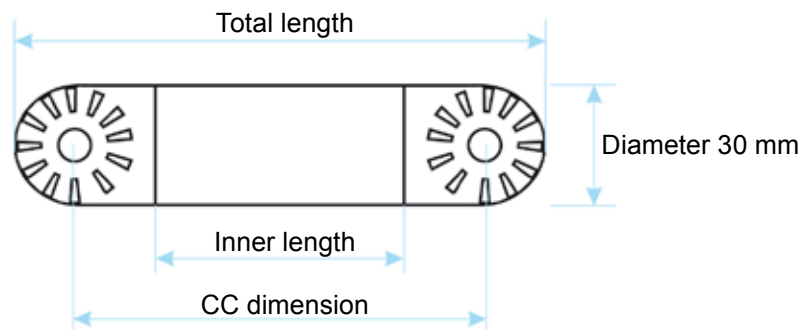

MOUNTING/BASE PLATES & TOPS

- Create your own unique solution by combining mounting plates and tops with various Pedestal Mount parts



Item no. 215522



Item no. 215597

ROUND MOUNTING/BASE PLATES

- Round mounting/base plates for added stability
- Spreads the strain on the mounting surface thanks to hole pattern over a larger area
- Thickness 9 mm

Item no.	Product	Diameter	Predrilled holes
215522	Round mounting plate	100 mm	AMPS holes + 6 holes
215807	Round mounting plate	200 mm	AMPS holes



Item no.	Product	Diameter	Predrilled holes
215597	Round mounting plate	100 mm	2x6 holes
215598	Round mounting plate	150 mm	2x6 holes
215599	Round mounting plate	200 mm	2x6 holes



Item no. 215521

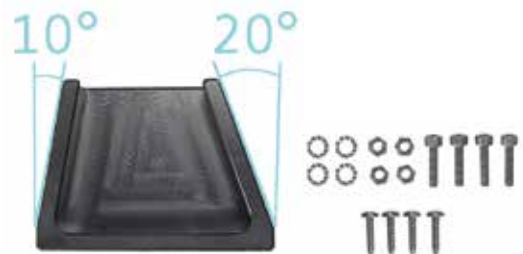

Item no. 215524

SWIVELING TOP PLATES

- For installation of equipment that needs to be turned for use from different directions
- Swivels 300°. Diameter 64 mm. Thickness 22 mm

Item no.	Product	Predrilled holes
215521	Swiveling top plate, adjustable in fixed steps	AMPS-holes + 4 holes
215905	Swiveling top plate, stepless adjustment	AMPS-holes + 4 holes



ANGLED TOP PARTS

- For installation of two devices back to back, for example a payment terminal and a printer
- Mounting surfaces are angled 10° and 20°
- Dimensions 64x64x46 mm (L+W+H)

Item no.	Product	Predrilled holes
215524	Angled top part 10° and 20°	3xAMPS holes + 1 large hole



VIBRATION DAMPERS

- Reduces vibrations and bumps, for use in a rough environment
- Mount the vibration dampers between the holder and the Pedestal Mount
- AMPS holes
- Builds 17 mm

REDUCES VIBRATIONS & BUMPS!



Item no. 215881



<i>Item no.</i>	<i>Product</i>	<i>Max weight</i>
215881	Vibration damper, hard (2 pcs)	For installations weighing up to 1500g
215882	Vibration damper, soft (2 pcs)	For installations weighing up to 300g



WINGNUTS & SCREWS

- For use on all Pedestal Mounts



Item no. 215670



Item no. 215535

<i>Item no.</i>	<i>Product</i>
215670	Wing nuts. Replaces standard nuts on Pedestal Mounts (2 pcs)
215535	Screw set. 2 screws + 2 nuts + 1 Allen key. Color: Black
216535	Screw set. 2 screws + 2 nuts + 1 Allen key. Color: Silver

VESA MOUNTING PLATES



Item no. 215756



Item no. 215748



Item no. 215753

<i>Item no.</i>	<i>Product</i>	<i>Predrilled holes</i>
215791	Single Vesa: 75 mm, rounded plate	Vesa + AMPS holes
215756	Dual Vesa: 75 mm and 100 mm, rounded plate	Dual Vesa + AMPS holes
215753	5 x Vesa: 75 mm, square plate	5 x Vesa + AMPS holes
215748	Single Vesa 75 mm, square plate	Vesa + AMPS holes



EXTENSION PARTS & PLATES FOR CABLE ENTRY

- Create your own unique solution by combining various cable entry Pedestal Mount parts
- Hollow Pedestal Mounts for cable entry
- Rod diameter 35 mm, hole inside diameter 25 mm

FOR CABLE ENTRY



EXTENSION PARTS WITH SWIVELING TOP FOR CABLE ENTRY

- Hollow Pedestal Mount extension part with swiveling top for cable entry
- 5 sets of AMPS-holes on top part
- Round mounting plate with 6 holes

<i>Item no.</i>	<i>Product</i>	<i>Total height</i>
215572	Swiveling Pedestal Mount for cable entry 4,5"	115 mm
215573	Swiveling Pedestal Mount for cable entry 6,5"	165 mm
215574	Swiveling Pedestal Mount for cable entry 8,5"	215 mm



EXTENSION PARTS FOR CABLE ENTRY

- Hollow Pedestal Mount extension parts for cable entry
- 4 sets of AMPS-holes on top part
- Round mounting plate with 6 holes

<i>Item no.</i>	<i>Product</i>	<i>Total height</i>
215564	Pedestal Mount for cable entry 4"	100 mm
215565	Pedestal Mount for cable entry 6"	150 mm
215566	Pedestal Mount for cable entry 8"	200 mm



ROUND MOUNTING/BASE PLATES FOR CABLE ENTRY

- Hollow Pedestal Mount mounting/base plates for cable entry
- Round mounting plates for added stability
- Spreads the strain on the mounting surface thanks to larger hole area
- Milled cable groove in the bottom
- Thickness 9 mm.

<i>Item no.</i>	<i>Product</i>	<i>Diameter</i>
215757	Mounting plate for cable entry	200 mm
215795	Mounting plate for cable entry	250 mm



TOPS & BASE/FOOT FOR CABLE ENTRY

- Create your own unique solution by combining various cable entry Pedestal Mount top parts.
- Hollow Pedestal Mount tops for cable entry



Item no. 215717



Item no. 215741



Item no. 215742

SWIVELING TOPS FOR CABLE ENTRY

- Square mounting plate 50x50 mm
- Tilts 180°

FOR CABLE ENTRY

Item no.	Product	Predrilled holes
215717	Top Part with 180° turnaround. Locking with handle	Dual AMPS holes + 4 holes
215741	Top Part with 180° turnaround. Locking with handle	RAM Mount holes + 4 holes
215742	Top Part with 180° turnaround. Locking with Allen Key	Dual AMPS holes + 4 holes

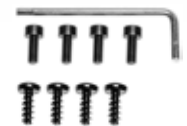
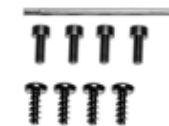
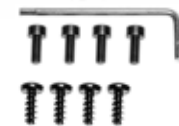
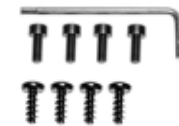
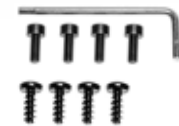
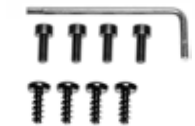

Item no. 215568

Item no. 215569

Item no. 215570

Item no. 215571

Item no. 215595

Item no. 215596

ANGLED TOPS FOR CABLE ENTRY

Item no.	Product	Top angle	Total height	Predrilled holes
215568	Angled top for cable entry	Angle: 15°	26 mm	Dual AMPS holes + 4 holes
215569	Angled top for cable entry	Angle: 30°	44 mm	Dual AMPS holes + 4 holes
215570	Angled top for cable entry	Angle: 45°	50 mm	Dual AMPS holes + 4 holes
215571	Angled top for cable entry	Angle: 60°	50 mm	Dual AMPS holes + 4 holes
215595	Angled top for cable entry	Angle: 75°	50 mm	Dual AMPS holes + 4 holes
215596	Angled top for cable entry	Angle: 90°	50 mm	Dual AMPS holes + 4 holes



BASE/FOOT FOR CABLE ENTRY

- Offers a stable mounting platform for all Pedestal Mounts
- Center hole diameter 15 mm, milled cable groove in the bottom
- 230x230x40 mm (LxWxH), 2571 g
- Made of Acetal plastic

Item no.	Product	Predrilled holes
215961	Stable base for cable entry	Multiple AMPS holes, radial adjustment



PEDESTAL MOUNTS

**SUPER STRONG MOUNTING SOLUTIONS
FOR INSTALLATION OF HEAVIER DEVICES**



- A modular system for a stable and strong installation of heavier devices
- Provides improved working environment with device within easy reach
- For use in any vehicle, flat surface, round pole or pipe, square rod
- Durable products with low weight, that withstand a lot of weight
- Contact Brodit for customized solutions on special projects
- Predrilled holes for easy attachment of a device holder
- Complete sets, or mix and match your own solution
- For professional everyday use
- Discreet design, color: black
- Solid and hollow range
- Made of aluminum
- Made in Sweden