



Zoom Bullet Series Hardware Manual

B43, B412, B415, B416, B419
I42, I48

2018/12/25



ACTi
Connecting Vision

Table of Contents

Precautions	4
Safety Instructions	6
Introduction	7
The List of Models	7
Package Contents.....	8
Physical Description	9
B43, B412, B419	9
B415, B416, I42, I48	11
Mounting Options	13
Installation Procedures	14
Step 1: Before Installation	14
Step 2: Attach the Camera Bracket	14
Step 3: Mount the Camera	15
Step 4: Pan and Tilt the Camera	16
Step 5: Waterproof the Cable Connections	18
How to Waterproof the Ethernet Cable Using the Cable Gland	19
How to Waterproof the Cable Using the Conduit Gland	23
Step 6: Connect to Network.....	26
Step 7: Access Camera Live View	26
Other Connections.....	27
Connecting a Power Adapter (Optional)	27
Connecting Digital Input / Output Devices (Optional)	30
Connecting Audio Input / Output Devices (Optional)	33
Other Adjustments and Accessories	34
How to Install / Remove a Memory Card (Optional).....	34
How to Insert the Memory Card on B43, B412, B419	34

How to Insert the Memory Card on B415, B416, I42, I48.....	34
How to Remove the Memory Card.....	35
How to Position Camera for Corridor View Format	36
How to Attach the Sunshield	38
How to Reset the Camera	39
<u>Accessing the Camera</u>	<u>40</u>
Configure the IP Addresses.....	40
Access the Camera.....	44

Precautions

Read these instructions

Read all the safety and operating instructions before using this product.

Heed all warnings

Adhere to all the warnings on the product and in the instruction manual. Failure to follow the safety instructions given may directly endanger people, cause damage to the system or to other equipment.

Servicing

Do not attempt to service this product yourself as opening or removing covers may expose you to dangerous voltage or other hazards. Refer all servicing to qualified service personnel.

Trademarks

ACTi and ACTi logo are registered trademarks of ACTi Corporation. All other names and products used in this manual are registered trademarks of their respective companies.

Liability

Every reasonable care has been taken during the writing of this manual. Please inform your local office if you find any inaccuracies or omissions. ACTi will not be held responsible for any typographical or technical errors and reserves the right to make changes to the product and manuals without prior notice.

Federal Communications Commission Statement



This equipment has been tested and found to comply with the limits for a class B digital device, pursuant to Part 15 of the FCC Rules. These limits are designed to provide reasonable protection against harmful interference in a residential installation. This equipment generates, uses, and can radiate radio frequency energy and, if not installed and used in accordance with the instructions, may cause harmful interference to radio communications. However, there is no guarantee that interference will not occur in a particular installation. If this equipment does cause harmful interference to radio or television reception, which can be determined by turning the equipment off and on, the user is encouraged to try to correct the interference by one or more of the following measures:

- Reorient or relocate the receiving antenna.
- Increase the separation between the equipment and receiver.
- Connect the equipment into an outlet on a circuit different from that to which the receiver is connected.
- Consult the dealer or an experienced radio/TV technician for help.

Warning: Changes or modifications to the equipment that are not expressly approved by the responsible party for compliance could void the user's authority to operate the equipment.

European Community Compliance Statement



This product has been tested and found to comply with the limits for Class B Information Technology Equipment according to European Standard EN 55022 and EN 55024. In a domestic environment, this product may cause radio interference in which cause the user may be required to take adequate measures.

Safety Instructions

Cleaning

Disconnect this product from the power supply before cleaning.

Accessories and Repair Parts

Use only the accessories and repair parts recommended by the manufacturer.

Water and Moisture

Install other devices (such as PoE injector, alarm, etc.) that will be used with the camera in a dry place protected from weather.

Servicing

Do not attempt to service this product yourself. Refer all servicing to qualified service personnel.

Damage Requiring service

Disconnect this product from the power supply immediately and refer servicing to qualified service personnel under the following conditions.

- 1) When the power-supply cord or plug is damaged
- 2) If liquid has been spilled, or objects have fallen into the product.
- 3) If the inner parts of product have been directly exposed to rain or water.
- 4) If the product does not operate normally by following the operating instructions in this manual.

Adjust only those controls that are covered by the instruction manual, as improper adjustment of other controls may result in damage, and will often require extensive work by a qualified technician to restore the product to its normal operation.







Safety Check

Upon completion of any service or repairs to this product, ask the service technician to perform safety checks to determine if the product is in proper operating condition.

Introduction

The List of Models

This hardware manual contains the following models:

B43		5MP Video Analytics Zoom Bullet with D/N, Adaptive IR, Extreme WDR, SLLS, 30x Zoom lens
B412		3MP Video Analytics Zoom Bullet with D/N, Adaptive IR, Extreme WDR, SLLS, 10x Zoom lens
B415		2MP Video Analytics Zoom Bullet with D/N, Adaptive IR, Extreme WDR, SLLS, 20x Zoom lens
B416		2MP Video Analytics Zoom Bullet with D/N, Adaptive IR, Extreme WDR, SLLS, 30x Zoom lens
B419		5MP, Video Analytics Zoom Bullet, Day / Night, Extreme WDR, Superior Low Light Sensitivity, 10x optical
I42		2MP Video Analytics Zoom Bullet with D/N, Adaptive IR, Extreme WDR, ELLS, 36x Zoom lens
I48		2MP Video Analytics Zoom Bullet with D/N, Adaptive IR, Extreme WDR, SLLS, 33x Zoom lens

From the installation perspective these models are very similar; therefore you can use one manual for all of them.

Package Contents

Camera	Bracket Plate	Sunshield
		
Hexagon Screwdriver	Mounting Screw Kit	Sunshield Screws
		
Female Conduit Gland	Female Cable Gland	Gland Rubber Ring x2
		
Terminal Block (for Power)	Terminal Block (for DI/DO)	Quick Installation Guide + Warranty Card
		<div data-bbox="1082 1442 1270 1554" style="border: 1px solid black; padding: 5px; text-align: center;"> QIG + Warranty Card </div>
Drill Template Sticker		
<div data-bbox="344 1697 488 1861" style="border: 1px solid black; padding: 5px; text-align: center;"> Drill Template </div>		

NOTE: The pictures are for reference only. Actual items may slightly vary.

Physical Description

B43, B412, B419



	Item	Description
1	Ethernet Port	Connects to a network using a standard Ethernet cable.
2	Audio Input (Red)	Connects to a microphone with built-in amplifier. See Connecting Audio Input / Output Devices (Optional) on page 33 for more information. NOTE 1: The microphone must have a built-in amplifier. Connecting an ordinary microphone will dwarf sounds and will result in inaudible recording. NOTE 2: If the audio connectors will not be used, leave the rubber caps on to ensure cables remain waterproof and eliminate short-circuit hazards.
	Audio Output (Green)	Connects to audio output devices, such as a speaker, etc. See Connecting Audio Input / Output Devices (Optional) on page 33 for more information. NOTE: If the audio connectors will not be used, leave the rubber caps on to ensure cables remain waterproof and eliminate short-circuit hazards.

Item		Description
3	DC 12V Power Input	In case the camera is connected to a non-PoE (Power over Ethernet) switch, use this connector to connect the camera to an external power adapter (not included). See Connecting a Power Adapter (Optional) on page 27 for more information.
4	Reset Button	Use the reset button to restore the camera to its factory default settings. See How to Reset the Camera on page 39.
5	Digital Input / Output	Connects to digital input or output devices, such as an alarm trigger, panic button, etc. Digital Input (DI) and Digital Output (DO) devices are used in applications like motion detection, event triggering, alarm notifications, etc. See Connecting Digital Input / Output Devices (Optional) on page 30 for information on how to connect DI/DO devices to your camera.
6	Memory Card Slot	The Memory Card Slot located inside the back cover is used to insert a memory card for local recording. See How to Install / Remove a Memory Card (Optional) on page 34.
7	Dehumidifier	Use to release moisture trapped inside the camera chassis.
8	Built-in Microphone	Use to monitor or record voices along with the video. Select whether to use the built-in or the line-in microphone as source of audio from the camera web configurator. See the camera Firmware Manual for details.

B415, B416, I42, I48





Item		Description
1	Ethernet Port	Connects to a network using a standard Ethernet cable.
2	Audio Input (Red)	Connects to a microphone with built-in amplifier. See Connecting Audio Input / Output Devices (Optional) on page 33 for more information. NOTE 1: The microphone must have a built-in amplifier. Connecting an ordinary microphone will dwarf sounds and will result in inaudible recording. NOTE 2: If the audio connectors will not be used, leave the rubber caps on to ensure cables remain waterproof and eliminate short-circuit hazards.
	Audio Output (Green)	Connects to audio output devices, such as a speaker, etc. See Connecting Audio Input / Output Devices (Optional) on page 33 for more information. NOTE: If the audio connectors will not be used, leave the rubber caps on to ensure cables remain waterproof and eliminate short-circuit hazards.

Item		Description
3	DC 12V Power Input	In case the camera is connected to a non-PoE (Power over Ethernet) switch, use this connector to connect the camera to an external power adapter (not included). See Connecting a Power Adapter (Optional) on page 27 for more information.
4	Reset Button	Use the reset button to restore the camera to its factory default settings. See How to Reset the Camera on page 39.
5	Digital Input / Output	Connects to digital input or output devices, such as an alarm trigger, panic button, etc. Digital Input (DI) and Digital Output (DO) devices are used in applications like motion detection, event triggering, alarm notifications, etc. See Connecting Digital Input / Output Devices (Optional) on page 30 for information on how to connect DI/DO devices to your camera.
6	Memory Card Slot	The Memory Card Slot located inside the back cover is used to insert a memory card for local recording. See How to Install / Remove a Memory Card (Optional) on page 34.
7	Power LED	The Power LED lights red when the camera is powered on and goes off once the camera boot-up process is complete. NOTE: For typical use, the power LED is hidden inside the housing and cannot be seen. However, knowing how the Power LED works is essential when troubleshooting or doing a reset.

Mounting Options

There are several mounting options that you can use to install the camera. Select the most suitable solution for your installation environment.

Mount Types	Accessories
Wall Mount	Suitable when mounting the camera directly on walls using the integrated bracket. See Installation Procedures on page 14.
Gang Box Converter	Suitable for locations which require the use of gang boxes. The Gang Box Converter is attached to the gang box while the camera with its bundled bracket is installed on the Gang Box Converter. All cables are hidden inside the gang box.
	PMAX-0806 
Vertical Pole Mount	Suitable when mounting the camera on vertical poles.
	PMAX-0504 or PMAX-0505 

NOTE:

- For more information about the mounting solutions and accessories, please check the [Mounting Accessory Selector](http://www.acti.com/mountingselector) in our website (<http://www.acti.com/mountingselector>).
- The above mounting accessories are not included in the package. Contact your sales agents to purchase.

Installation Procedures

This section describes the procedures in installing the camera on the wall using the integrated bracket.

IMPORTANT! Before installation, make sure the wall can bear more than the weight of the camera and its bracket.

NOTE: The following procedures and pictures are based on the cable going along the wall; same procedures apply when the cable will pass through the wall, unless otherwise specified.

Step 1: Before Installation

The following steps may or may not be applicable to your installation environment. However, if needed, these steps must be done before installing the camera.

1. As needed, insert the memory card into the memory card slot. See [How to Install / Remove a Memory Card \(Optional\)](#) on page 34.
2. Determine if the camera will be used in normal or corridor format. See [How to Position Camera for Corridor View Format](#) on page 36.
3. Attach the sunshield. See [How to Attach the Sunshield](#) on page 38.

Step 2: Attach the Camera Bracket

1. Attach the bracket to the camera.



2. Secure the bracket by threading the lock knot.



Step 3: Mount the Camera

1. Attach the supplied drill template sticker on the surface.
2. Determine how the cable will be routed: ***pass through a hole on the surface*** or ***along the surface***.
 - ***If the cables will pass through a hole on the surface***, drill the cable hole and the three (3) screw holes on the surface.
 - ***If the cables will be routed along the surface***, just drill the three (3) screw holes.
3. Detach the drill template sticker and insert the plastic plugs into the screw holes.
4. ***If the cables will pass through a hole on the surface***, route the cables through the hole on the wall.
If the cables will go along the wall, route the cables through the gap on the bracket.



5. Attach the camera to the surface using the three (3) supplied screws.



Step 4: Pan and Tilt the Camera

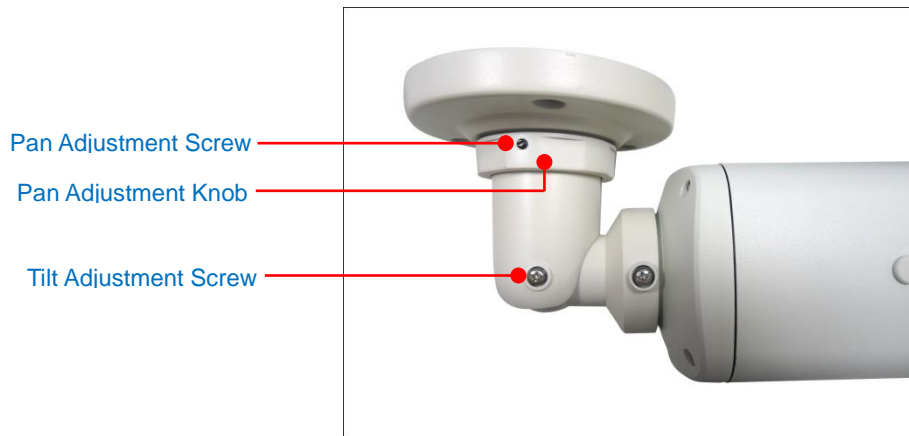

1. Slightly loosen the Pan Adjustment Knob and pan the camera.



2. When panning is done, tighten the knob. Tighten the set screw on the knob to fix the pan position.

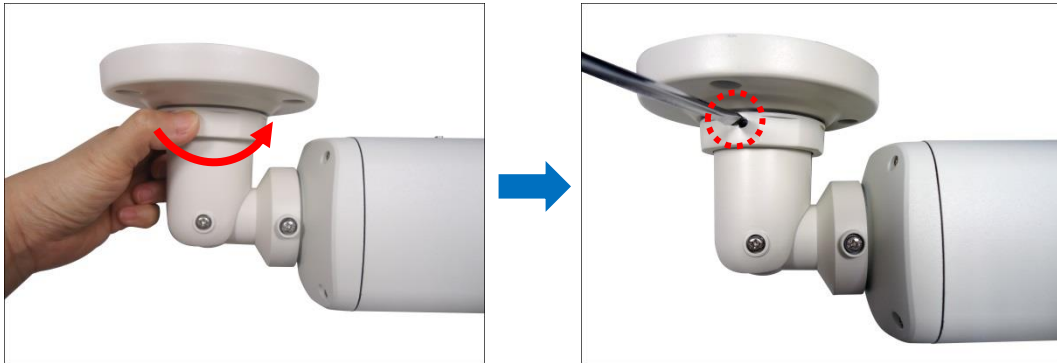

3. Loosen the Tilt Adjustment Screw to adjust the camera tilt angle. When done, tighten the Tilt Adjustment Screw to fix the tilt position.

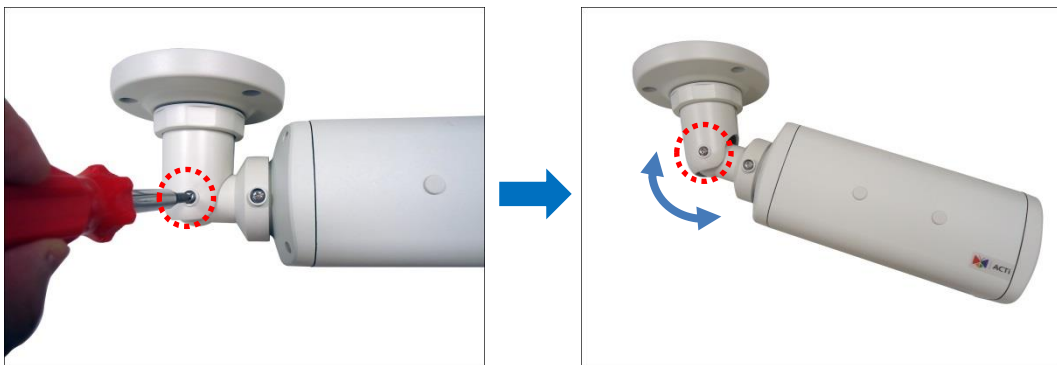

Step 5: Waterproof the Cable Connections

The camera and the cables are resistant to salt, water, weak acid, alcohol, oil, grease and other common solvents. However, users must ensure that the cable connection and the network side cable itself are also protected from different environmental factors.

There are two ways to waterproof the Ethernet port cable.

Bundled Cable Gland	Bundled Conduit Gland
 <p data-bbox="237 1043 778 1122">For use with an exterior-grade Ethernet cable (not included in the package).</p>  <p data-bbox="237 1413 778 1491">See How to Waterproof the Ethernet Cable Using the Cable Gland on page 19.</p>	 <p data-bbox="807 1028 1246 1106">For use with 1/2" flexible conduit (not included in the package).</p>  <p data-bbox="807 1413 1315 1491">See How to Waterproof the Cable Using the Conduit Gland on page 23.</p>

How to Waterproof the Ethernet Cable Using the Cable Gland

1. Prepare the following items:

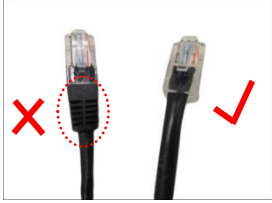
Cable Gland	Gland Rubber Ring	Exterior-Grade Ethernet Cable
		 <p>NOTE: Not included in the camera package.</p>

2. Detach the cable gland as shown below.



3. Insert the clamping nut through the Ethernet cable.



4. Insert the Ethernet cable through the sealing rubber and claw.



5. Attach one (1) supplied rubber ring on the gland body (smooth end).

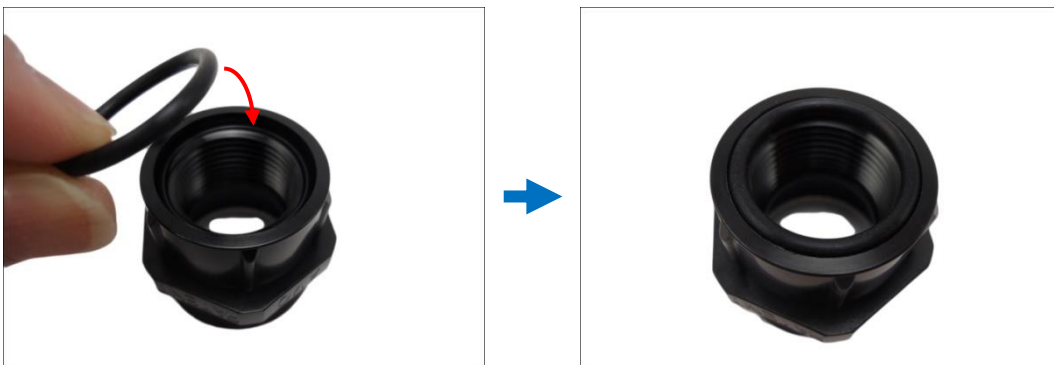

NOTE: Make sure the rubber ring is completely aligned on the gap on the gland body.

6. Attach the gland body to the Ethernet port of the camera.



IMPORTANT!

Make sure the rubber ring is completely aligned and flat on the gland body to avoid possible water leakage.

7. Connect the Ethernet connector to the Ethernet port of the camera.



8. Insert the sealing rubber and claw into the cable gland body.

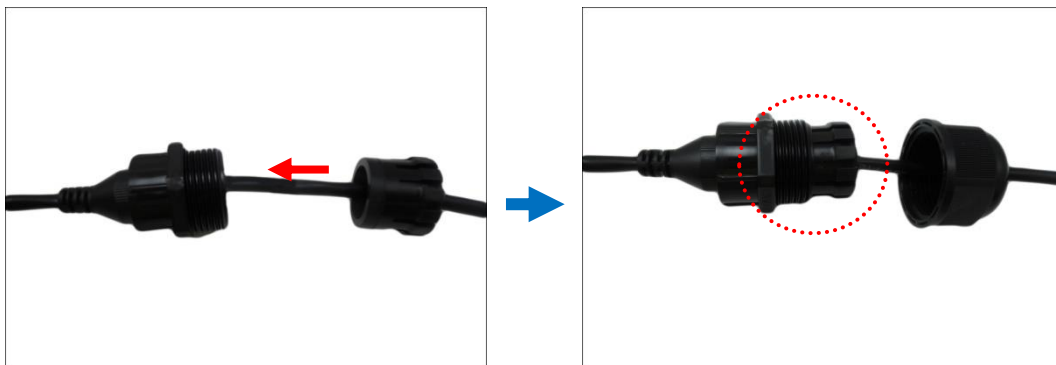

9. Attach the clamping nut to the cable gland body. Make sure the clamping nut is tightly secured and the rubber is squeezed in to avoid water leakage.

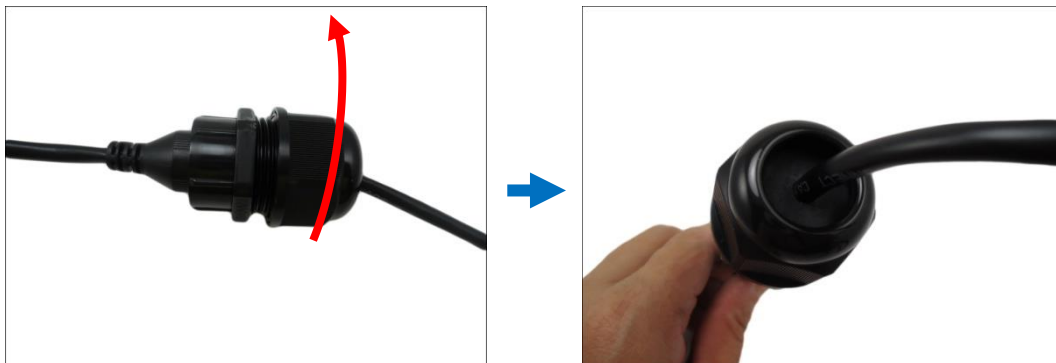

10. If connecting other devices, such as digital input/output, audio, power adapter, etc., connect the cables according to the instructions in:
 - a. To connect the power adapter, see [Connecting a Power Adapter \(Optional\)](#) on page 27.
 - b. To connect digital input or output device, see [Connecting Digital Input / Output Devices \(Optional\)](#) on page 30.
 - c. To connect audio input or output device, see [Connecting Audio Input / Output Devices \(Optional\)](#) on page 33.

NOTE: Different applications and installation environments require different types of waterproofing methods which may not be covered in this manual. Check your installation environment and adapt a suitable waterproofing method.

How to Waterproof the Cable Using the Conduit Gland

1. Prepare the following items:

Conduit Gland	Gland Rubber Ring	1/2" Flexible Conduit
		 <p>NOTE: Not included in the camera package.</p>

2. Detach the conduit gland as shown below.



3. Insert the Ethernet cable through the flexible conduit. Then insert the clamping nut through the flexible conduit.



4. Insert the sealing rubber and attach it at the end of the flexible conduit.

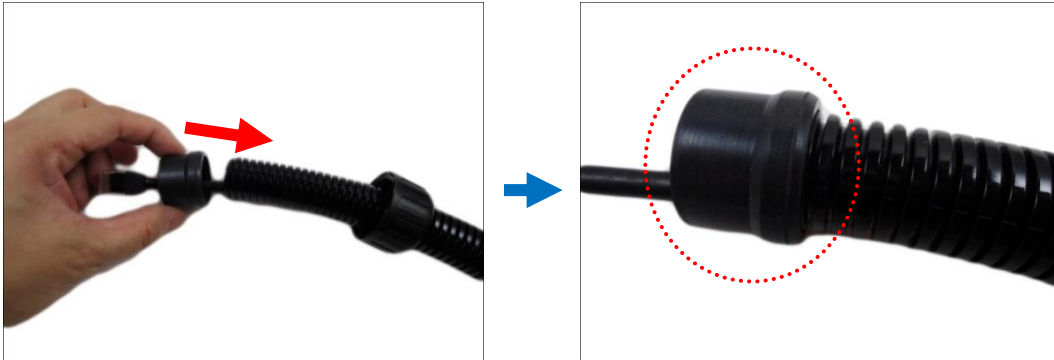

5. Attach one (1) supplied rubber ring on the gland body (smooth end).

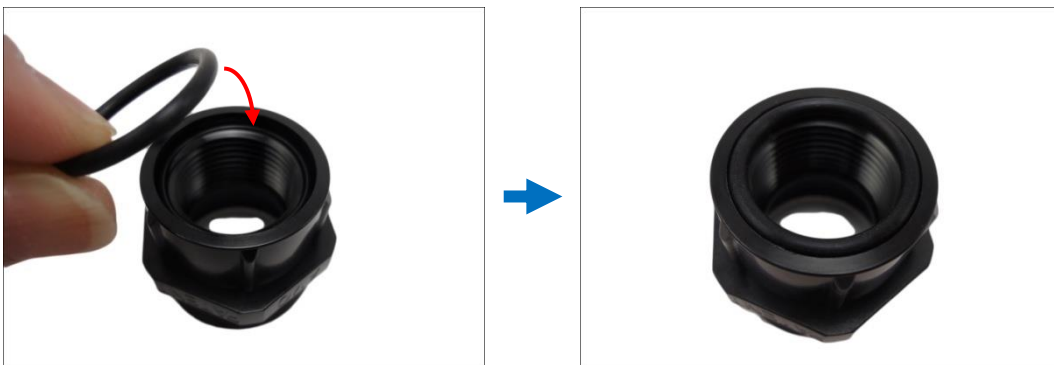

NOTE: Make sure the rubber ring is completely aligned on the gap on the gland body.

6. Attach the gland body to the Ethernet port of the camera.



IMPORTANT!

Make sure the rubber ring is completely aligned and flat on the gland body to avoid possible water leakage.

7. Connect the Ethernet connector to the Ethernet port of the camera.



8. Insert the sealing rubber into the conduit gland body.

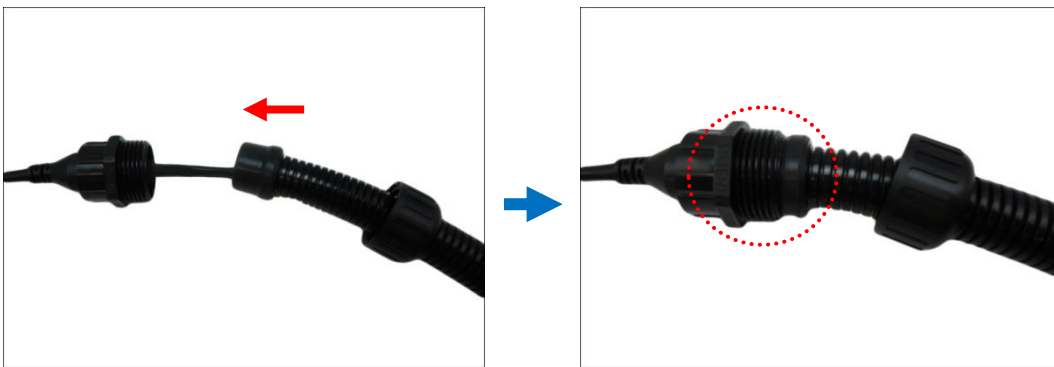

9. Attach the clamping nut to the conduit gland body. Make sure the clamping nut is tightly secure to avoid water leakage.



10. If connecting other devices, such as digital input/output, audio, power adapter, etc., connect the cables according to the instructions in:
 - a. To connect the power adapter, see [Connecting a Power Adapter \(Optional\)](#) on page 27.
 - b. To connect digital input or output device, see [Connecting Digital Input / Output Devices \(Optional\)](#) on page 30.
 - c. To connect audio input or output device, see [Connecting Audio Input / Output Devices \(Optional\)](#) on page 33.

NOTE: Different applications and installation environments require different types of waterproofing methods which may not be covered in this manual. Check your installation environment and adapt a suitable waterproofing method.

Step 6: Connect to Network

Connect the other end of the network cable to a switch or injector. Then, connect the switch or injector to a network or PC and a power source. See Power-over-Ethernet (PoE) example connection diagram below.

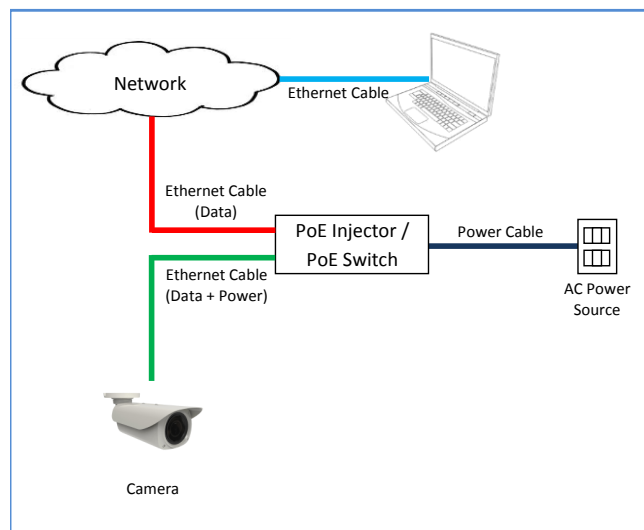

In case of using a non-PoE switch, power up the camera using a power adapter (not supplied). As needed, power up the other connected devices.

Step 7: Access Camera Live View

See [Accessing the Camera](#) on page 40 for more information on how to access the camera live view.

Other Connections

This section describes the procedures in preparing the external devices that you can connect to the camera. The camera supports DC12V power input, Digital Input and Output (DI/DO) and Audio Input and Output devices. The use of these devices, however, is optional.

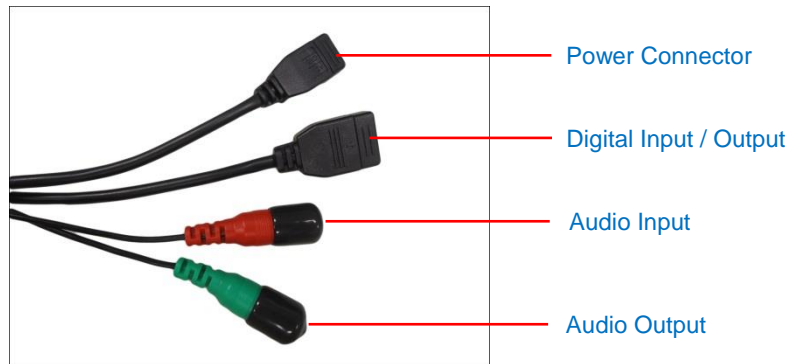

NOTE: If these connectors will not be used, leave the covers on and adapt a suitable waterproofing method to ensure cables remain protected from water and eliminate short-circuit hazards.

Connecting a Power Adapter (Optional)

In case of using a non-PoE switch or your PoE switch has limited power supply, you can purchase a power adapter and directly connect the camera to a power outlet. The power adapter must be connected to the supplied terminal block before use.

To do this, follow the procedures below:

1. Loosen the screws of the **12V** and **GND** pins of the power terminal block.



2. Take note that a standard power adapter cable has two (2) different wires:

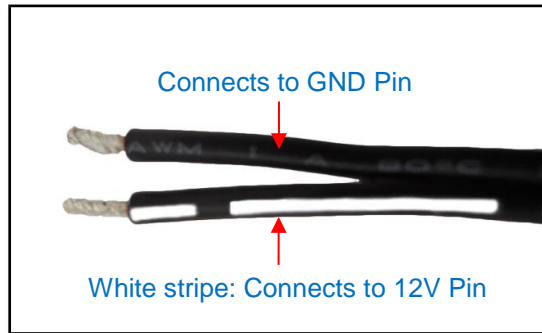

3. Connect the wire with the white stripe to the **12V** pin and the other to the **GND** pin.

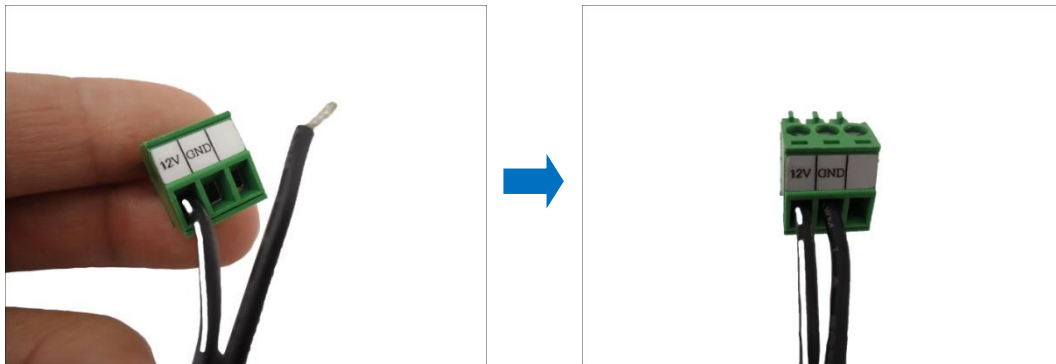

NOTE: The terminal block pictures are for reference only, note that actual label placement may vary per model.

4. Tighten the screws of the **12V** pin and the **GND** pins to secure the wire connection.



5. Below is an example of a power adapter with an attached terminal block. Connect the terminal block connector to the connector on the camera.



NOTE: The power adapter is not bundled in the package.

Connecting Digital Input / Output Devices (Optional)

Depending on your surveillance needs, you may connect digital input / output devices to your camera using the supplied terminal block.

Digital Input (DI) devices can be used to notify the camera about an activity in the camera site. DI can be triggers of events. For example, you can connect a “panic button” to the camera; as such when the panic button is pressed, the alarm signal will be sent through the camera. Other common DI device applications are emergency button, smoke detector, passive infrared sensor, etc.

Digital Output (DO) devices are external devices that are activated by the camera upon an event inside the camera. For example, you can connect an “alarm horn” to the camera; as such when an event occurs inside the camera (e.g. detected intruder), the alarm horn will sound. Other common DO device applications are motion-triggered lights, electric fence, magnetic door locks, etc.



To connect digital input / output devices (DI/DO), map the pins to one of the pin combinations below:

Device	Pin	Mapping Instructions
Digital Output (DO)	12V	Connect the wires of the output device to 12V and DO .
	DO	
Digital Input (DI)	GND	Connect the wires of the input device to GND and DI .
	DI	

Loosen the screw and insert the wire through the pin slot on the terminal block, then tighten the screw to secure the wire. Connect the terminal block to the cable connector of the camera.

After mapping the wires, connect the terminal block to the connector on the camera and make sure to wrap the cable connection using a waterproof tape.

The table below shows the DI/DO connection specifications:

Device			
DI	Connection design		TTL - compatible logic levels
	Voltage	To trigger (low)	Logic level 0: 0V ~ 0.4V
		Normal (high)	Logic level 1: 3.1V ~ 30V
	Current		10mA ~ 100mA
DO	Connection design		Transistor (Open Collector)
	Voltage & Current		< 24V DC, < 50mA

Typical Connection

Based on these specifications, if the DI device has a voltage of 0V ~ 30V or the DO device has a voltage of < 24V (< 50mA), then the camera can supply internal power to these devices and there is no need to connect the DI/DO device to an external power source.

In this case, use the **GND** and **DI** pins to connect a DI device and use the **12V** and **DO** pins to connect a DO device. See wiring scheme below:

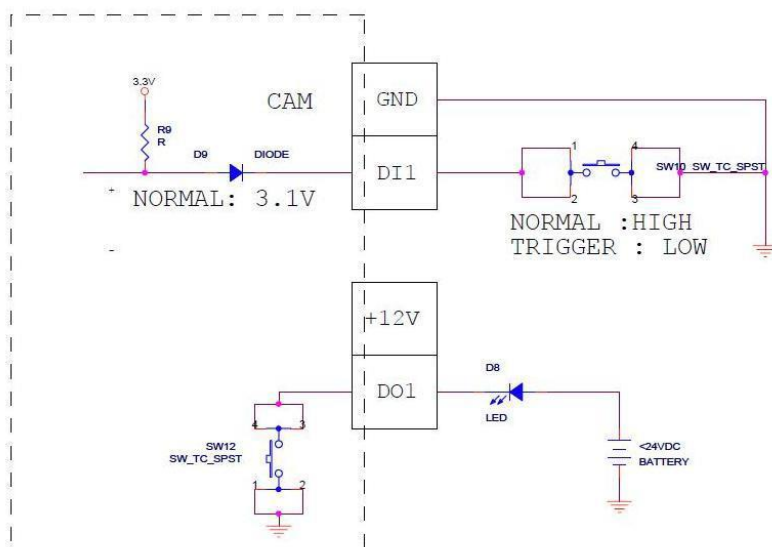

High Voltage DO Device Connection

Even though the camera provides 12V power, this may not be enough for some high voltage DO devices, such as a ceiling light or a motor that opens or closes a gate. In this case, there is a need to connect an external relay. See wiring scheme below:

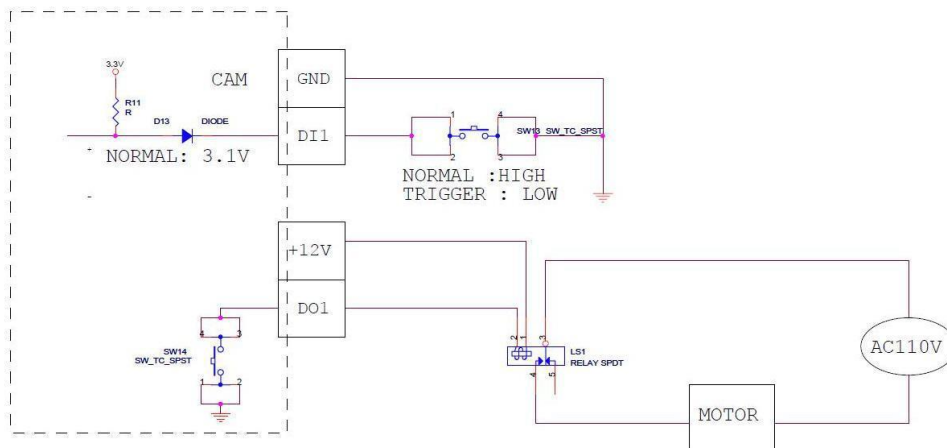

Note that when choosing an appropriate relay, please refer to its specifications and make sure they match the above design. The triggering circuit voltage has to be around 12V DC and the switch-controlled circuit voltage has to match the external power supply (e.g. 110V AC or 220V AC).

The illustration below is a graphic example of connecting a relay to a high voltage DO device.

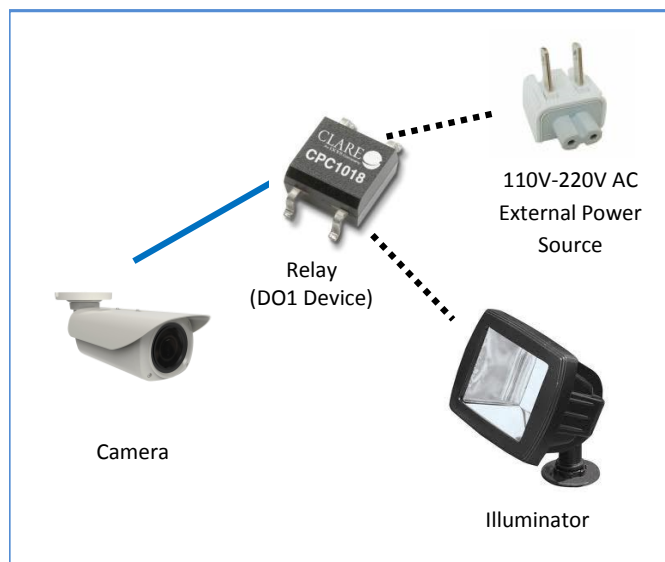

NOTE: For more information on DI/DO connections, please refer to the Knowledge Base article [All About Digital Input and Digital Output](#) downloadable from the link below (<http://Download.acti.com?id=516>).

Connecting Audio Input / Output Devices (Optional)

If using an audio input device, such as a microphone with a built-in amplifier, connect the device to the **Audio Input** jack (RED) of the camera. If using an audio output device, such as a speaker, connect the device to the **Audio Output** jack (GREEN) jack of the camera.

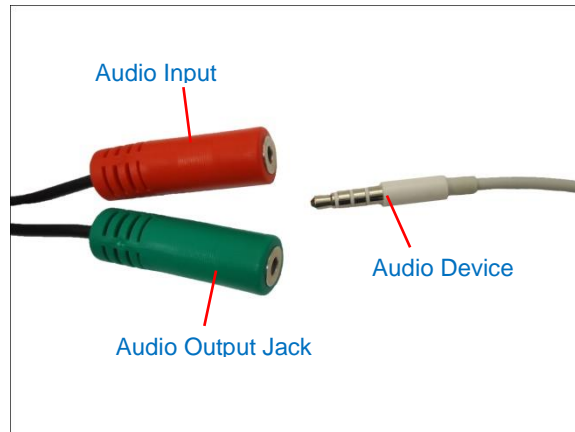

NOTE: Make sure that the connected audio input device has a built-in amplifier. Connecting an ordinary microphone will dwarf sounds and will result in inaudible recording. Enable **Audio In** and select **Line in** as the **Microphone Type** in the camera firmware to receive audio.

After connecting a device, make sure to wrap the cable connection using a waterproof tape.

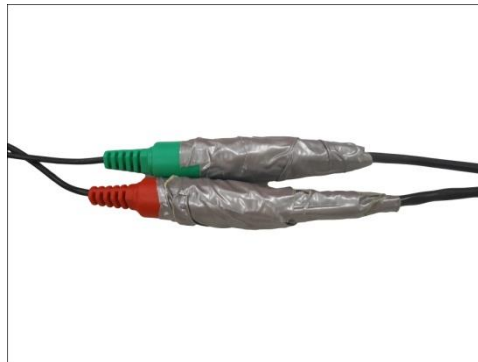

Other Adjustments and Accessories

How to Install / Remove a Memory Card (Optional)

The camera supports local video recording and saving of snapshots to a memory card.

NOTE: Supports microSDHC and microSDXC cards.

How to Insert the Memory Card on B43, B412, B419

The memory card slot on B43, B412 and B419 are located inside the front cover.

1. Loosen the four (4) screws to open the front cover of the camera.
2. Insert a memory card into the slot with the metallic contacts facing down. Push the card until it clicks into place.
3. Once the card is inserted, close the front cover.

NOTE: Make sure the rubber on the front cover is in place when closing the front cover.

How to Insert the Memory Card on B415, B416, I42, I48

1. Loosen the four (4) screws to open the back cover of the camera.

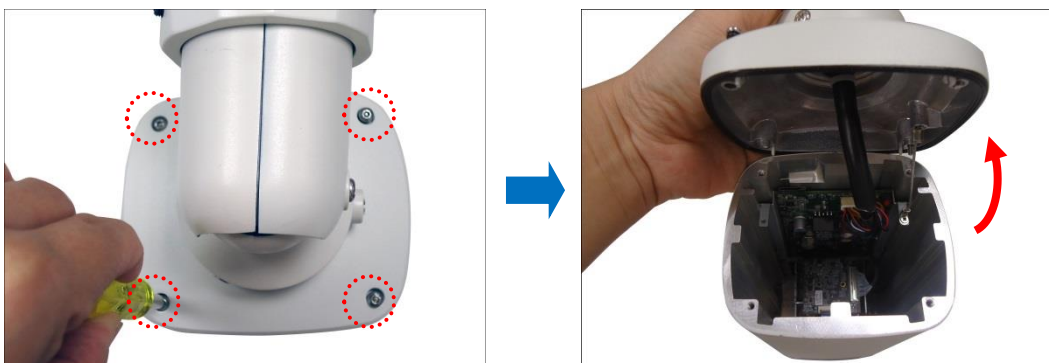

2. Insert a memory card into the card slot with the metallic contacts facing down. Push the card until it clicks into place.

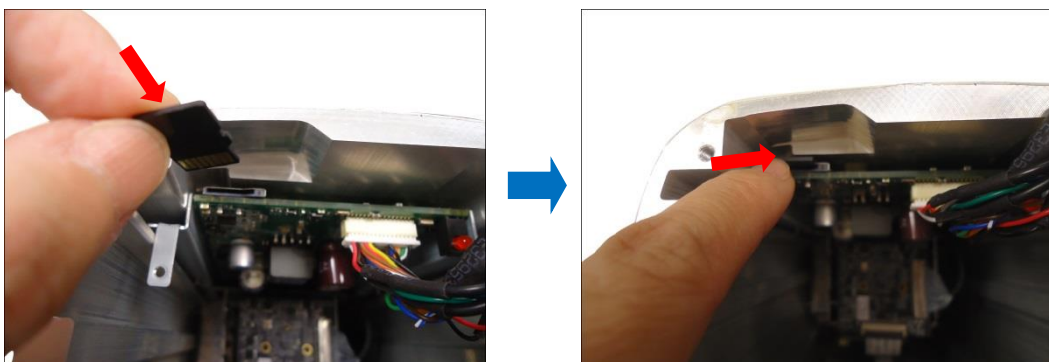

3. Once the card is inserted, close the back cover.

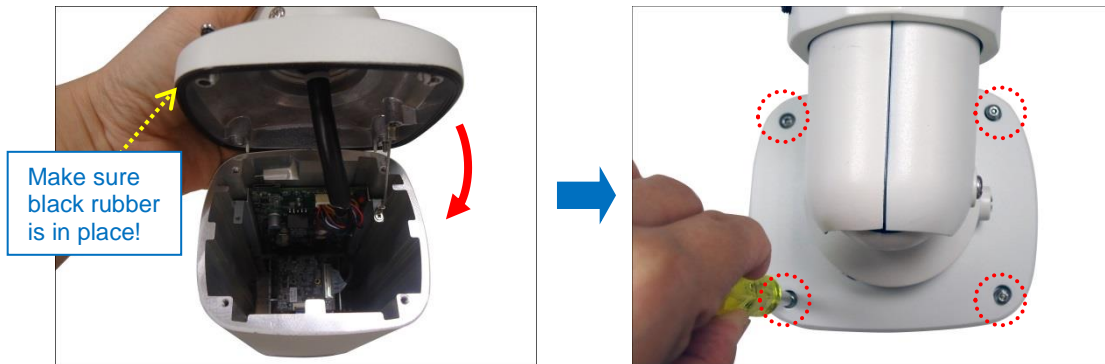

NOTE: Make sure the rubber on the back cover is in place when closing the back cover.

How to Remove the Memory Card

In case there is a need to remove the card, make sure to access the camera Web Configurator to safely “unmount” the card first (see the camera Firmware manual for more information). Once unmounted from the firmware, push the card to eject it from the slot.

How to Position Camera for Corridor View Format

The camera supports the following viewing format:

- Horizontal: The camera has a wider viewing angle horizontally.
- Corridor: The camera has wider viewing angle vertically.

The camera is set to horizontal viewing angle, by default. To change between Horizontal and Corridor format, do the following:

1. Loosen the Rotation Adjustment Screw and adjust the camera body orientation.

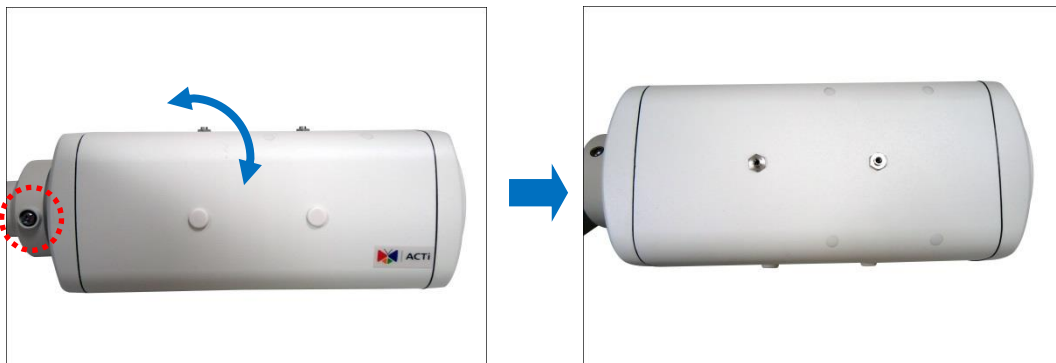

2. Tighten the Rotation Adjustment Screw to fix the camera orientation position.
3. Attach the sunshield to its position based on the camera orientation. Since the default sunshield position is for the camera normal view format, you must move the set screw position first.
4. Remove the two (2) set screws from its original position.

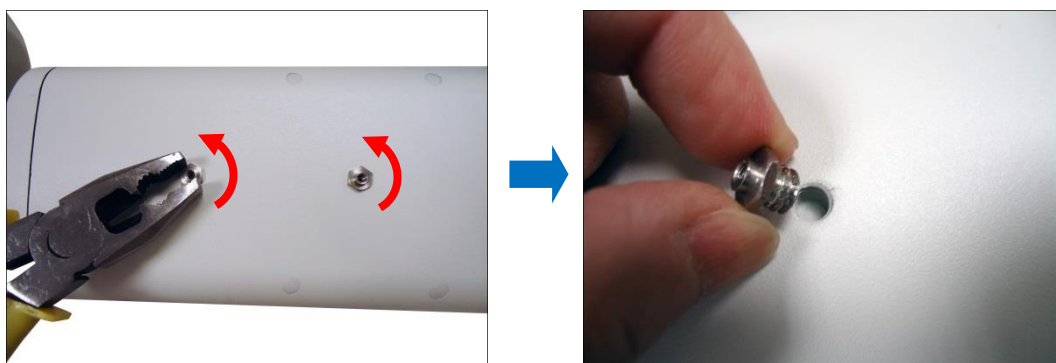

5. Remove the two (2) rubber plugs covering the screw holes to which the sunshield will be attached.

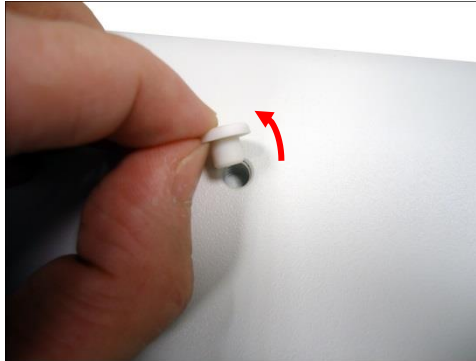

6. Attach the two (2) sunshield screws to the holes to which the sunshield will be attached.
7. Cover the unused screw holes with the two (2) rubber plugs.
8. Follow the instructions on [How to Attach the Sunshield](#) on page 38. Note that the instructional pictures may show a different camera orientation; the procedures are the same, though.

How to Attach the Sunshield

1. Loosely secure the supplied screws to attach the sunshield.



2. Slide to adjust the sunshield to cover the lens as far as possible.



NOTE: The sunshield may have to be adjusted later based on the camera live view.

3. Tighten the screws to secure the sunshield.



How to Reset the Camera

The purpose of the Reset Button is to restore the factory default settings of the camera, including the administrator's password.

The reset button can be used for following purposes:

- The administrator's password has been forgotten and therefore the camera cannot be accessed.
- In case of IP address, mask, or allow/deny filter related issues, resulting with inability to modify these settings.
- In case of connectivity issues or abnormal video quality.

To reset the camera, do the following:

1. Remove the Reset Button cover.

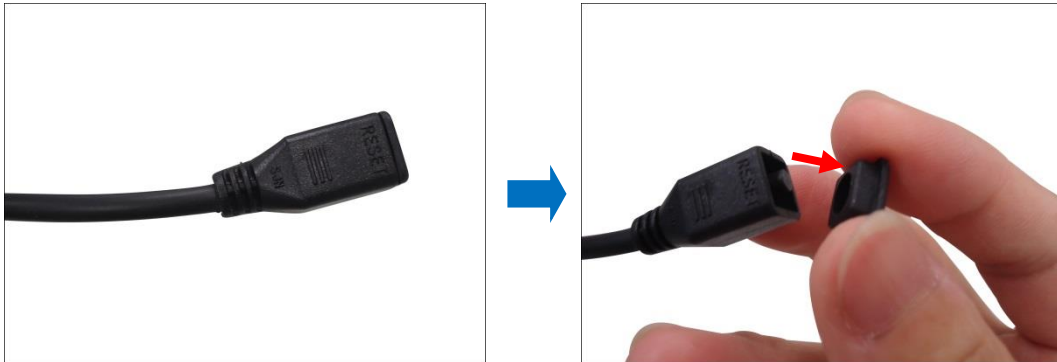

2. Press and hold the Reset button for at least 5 seconds.



Accessing the Camera

Configure the IP Addresses

In order to be able to communicate with the camera from your PC, both the camera and the PC have to be within the same network segment. In most cases, it means that they both should have very similar IP addresses, where only the last number of the IP address is different from each other. There are 2 different approaches to IP Address management in Local Area Networks – by DHCP Server or Manually.

Using DHCP server to assign IP addresses:

If you have connected the computer and the camera into the network that has a DHCP server running, then you do not need to configure the IP addresses at all – both the camera and the PC would request a unique IP address from DHCP server automatically. In such case, the camera will immediately be ready for the access from the PC. The user, however, might not know the IP address of the camera yet. It is necessary to know the IP address of the camera in order to be able to access it by using a Web browser.

The quickest way to discover the cameras in the network is to use the simplest network search, built in the Windows system – just by pressing the “Network” icon, all the cameras of the local area network will be discovered by Windows thanks to the UPnP function support of our cameras.

In the example below, we successfully found the camera model that had just connected to the network.

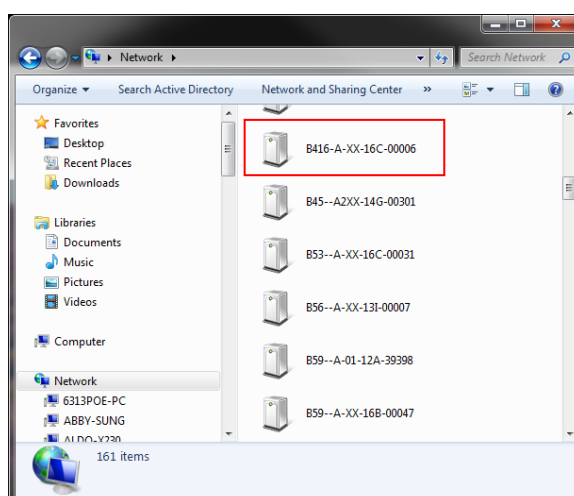

Double-click on the camera model name, the default browser of the PC is automatically launched and the IP address of the target camera is already filled in the address bar of the browser.

If you work with our cameras regularly, then **there is even a better way to discover the cameras in the network** – by using **IP Utility**. The IP Utility is a light software tool that can not only discover the cameras, but also list lots of valuable information, such as IP and MAC addresses, serial numbers, firmware versions, etc, and allows quick configuration of multiple devices at the same time.

Search and download IP Utility for free from <http://www.acti.com/DownloadCenter>.

With just one click, you can launch the IP Utility and there will be an instant report as follows:

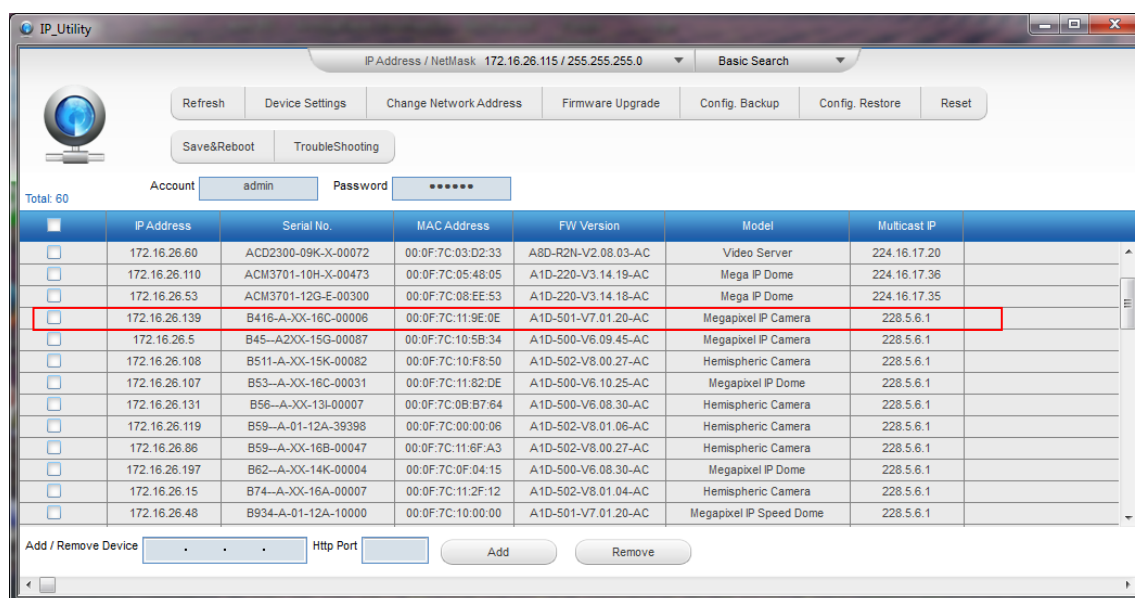

You can quickly notice the camera model in the list. Click on the IP address to automatically launch the default browser of the PC with the IP address of the target camera filled in the address bar of the browser already.

Use the default IP address of a camera:

If there is no DHCP server in the given network, the user may have to assign the IP addresses to both PC and camera manually to make sure they are in the same network segment.

When the camera is plugged into network and it does not detect any DHCP services, it will automatically assign itself a default IP:

192.168.0.100

Whereas the default port number would be **80**. In order to access that camera, the IP address of the PC has to be configured to match the network segment of the camera.

Manually adjust the IP address of the PC:

In the following example, based on Windows 7, we will configure the IP address to **192.168.0.99** and set Subnet Mask to **255.255.255.0** by using the steps below:

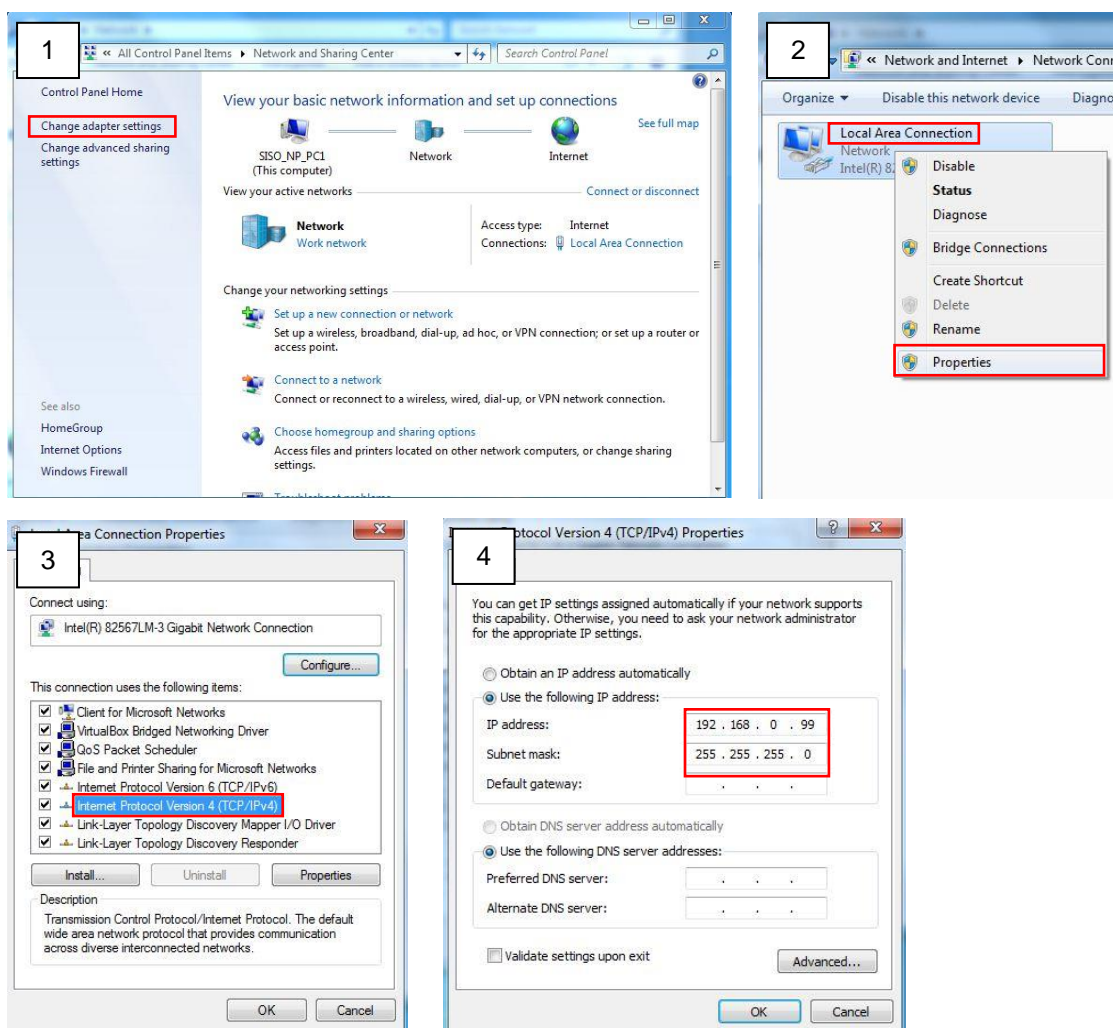

Manually adjust the IP addresses of multiple cameras:

If there are more than 1 camera to be used in the same local area network and there is no DHCP server to assign unique IP addresses to each of them, all of the cameras would then have the initial IP address of **192.168.0.100**, which is not a proper situation for network devices – all the IP addresses have to be different from each other. The easiest way to assign cameras the IP addresses is by using **IP Utility**:

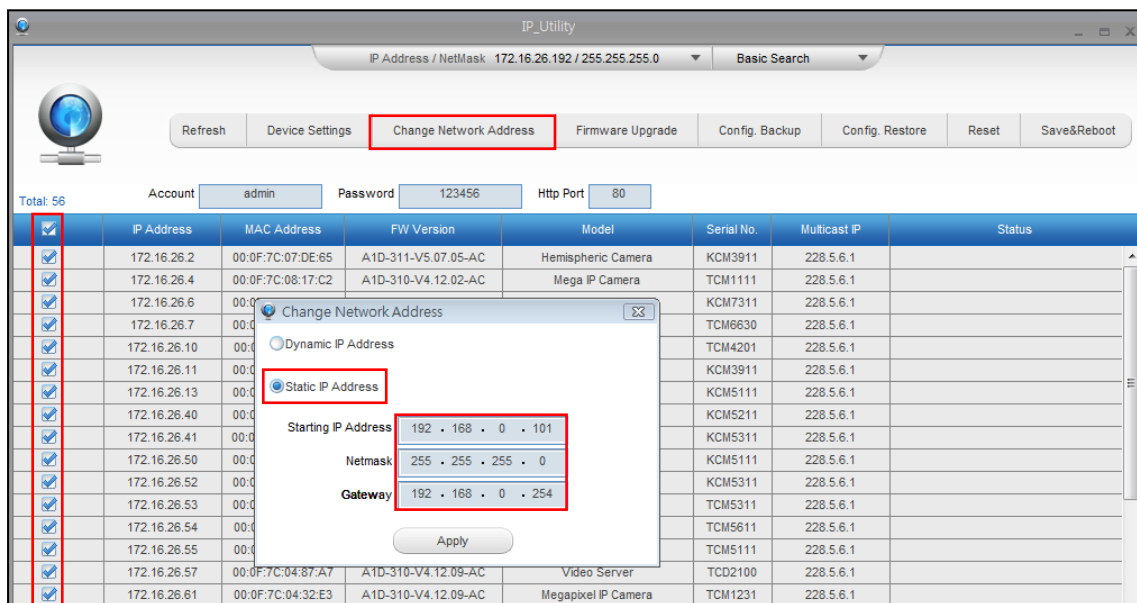

With the procedure shown above, all the cameras will have unique IP addresses, starting from 192.168.0.101. In case there are 20 cameras selected, the last one of the cameras would have the IP 192.168.0.120.

Later, by pressing the “Refresh” button of the IP Utility, you will be able to see the list of cameras with their new IP addresses.

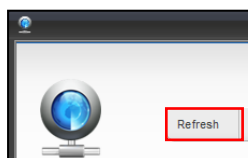

Please note that it is also possible to change the IP addresses manually by using the Web browser. In such case, please plug in only one camera at a time, and change its IP address by using the Web browser before plugging in the next one. This way, the Web browser will not be confused about two devices having the same IP address at the same time.

Access the Camera

Now that the camera and the PC are both having their unique IP addresses and are under the same network segment, it is possible to use the Web browser of the PC to access the camera.

You can use **Microsoft Internet Explorer** to access the camera.

When using Internet Explorer browser, the ActiveX control for video stream management will be downloaded from the camera directly – the user just has to accept the use of such control when prompted so. No other third party utilities are required to be installed in such case.

The examples in this manual are based on Internet Explorer browser in order to cover all functions of the camera.

Assuming that the camera's IP address is **192.168.0.100**, you can access it by opening the Web browser and typing the following address into Web browser's address bar:

http://192.168.0.100

Upon successful connection to the camera, the user interface called **Web Configurator** would appear together with the login page. The HTTP port number was not added behind the IP address since the default HTTP port of the camera is 80, which can be omitted from the address for convenience.

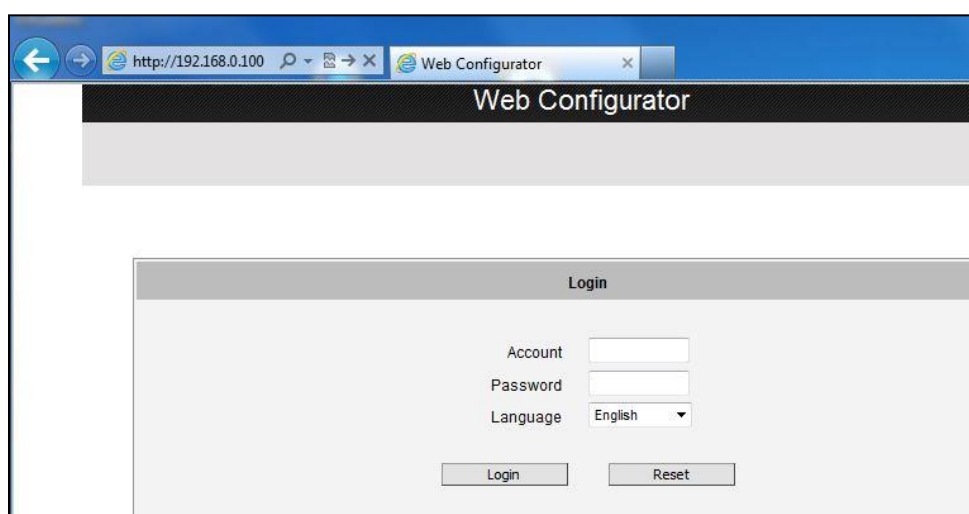

Before logging in, you need to know the factory default Account and Password of the camera.

Account: **Admin**

Password: **123456**

For further operations, please refer to the **Firmware User Manual**.



Copyright © 2016, ACTi Corporation All Rights Reserved

7F, No. 1, Alley 20, Lane 407, Sec. 2, Ti-Ding Blvd., Neihu District, Taipei, Taiwan 114, R.O.C.

TEL : +886-2-2656-2588 FAX : +886-2-2656-2599

Email: sales@acti.com