

ZQ210

Mobile Printer



User Guide



Contents

Proprietary Statements	5
Document Conventions	7
Introduction to the ZQ210 Printer	8
Unpacking and Inspection.....	9
Reporting Damage.....	9
ZQ210 Technology.....	10
Battery	10
QR Code.....	11
Made for iPhone (MFi).....	12
Near Field Communication (NFC).....	12
Printer Overview.....	13
Getting Ready to Print.....	15
Battery.....	15
Removing the Battery	15
Installing the Battery	17
Battery Safety	18
Charger Safety.....	18
Charging the Battery.....	19
AC-to-USB Charger	19
AC-to-USB Charger (cont.).....	20
Loading Media Procedure.....	22
Operator Controls	24
Standard User Controls	24
LCD Control Panel.....	24

Information Screen.....	26
Configuration Screen	27
Buttons.....	28
Power-Up Sequences.....	28
Verify the Printer is Working.....	28
Printing a Configuration Report.....	28
Connecting the Printer	29
Communication to the Printer	30
USB Communications.....	30
Zebra Setup Utilities.....	31
Wireless Communications with Bluetooth.....	31
Bluetooth Networking Overview.....	31
Bluetooth Security Modes.....	32
Bluetooth Minimum Security Modes	33
Setting Up the Software.....	35
Designing Labels	35
Using Pre-Printed Receipt Media.....	37
Black Mark Dimensions (Receipt Media).....	37
Label Areas.....	37
Label Design Examples	38
Keep-Out Areas	39
Near Field Communication (NFC).....	39
NFC Use Cases	40
Wearing the Printer	41
Swivel Belt Clip	41
Soft Case	42
Preventive Maintenance	43
Extending Battery Life.....	43
General Cleaning Instructions.....	43
LCD Control Panel Indicators	46
Troubleshooting Topics	46
Troubleshooting Tests	48
Printing a Configuration Label.....	48
Communications Diagnostics.....	48
Specifications	52
Printing Specifications.....	52

Memory and Communications Specifications 52

Label Specifications 53

Physical, Environmental and Electrical Specifications 53

CPCL Font and Bar Code Specifications and Commands 54

Printer Dimensions 55

Printer Accessories 56

Appendix A..... 57

 USB Cables 57

Appendix B..... 58

 Media Supplies 58

Appendix C..... 58

 Maintenance Supplies..... 58

Appendix D..... 59

Appendix E..... 60

 Battery Disposal 60

 Product Disposal 60

Appendix F..... 61

 Alert Messages 61

Appendix G 62

 Using Zebra.com..... 62

Appendix H..... 64

 Product Support 64

Index 65

Copyright

ZEBRA and the stylized Zebra head are trademarks of Zebra Technologies Corporation, registered in many jurisdictions worldwide. All other trademarks are the property of their respective owners. ©2019 Zebra Technologies Corporation and/or its affiliates. All rights reserved.

Information in this document is subject to change without notice.

For further information regarding legal and proprietary statements, please go to:

COPYRIGHTS AND TRADEMARKS: For complete copyright and trademark information, go to www.zebra.com/copyright
WARRANTY: For complete warranty information, go to www.zebra.com/warranty
END USER LICENSE AGREEMENT: For complete EULA information, go to www.zebra.com/eula

Terms of Use

Proprietary Statement: This manual contains proprietary information of Zebra Technologies Corporation and its subsidiaries (“Zebra Technologies”). It is intended solely for the information and use of parties operating and maintaining the equipment described herein. Such proprietary information may not be used, reproduced, or disclosed to any other parties for any other purpose without the express, written permission of Zebra Technologies.

Product Improvements: Continuous improvement of products is a policy of Zebra Technologies. All specifications and designs are subject to change without notice.
Liability Disclaimer: Zebra Technologies takes steps to ensure that its published Engineering specifications and manuals are correct; however, errors do occur. Zebra Technologies reserves the right to correct any such errors and disclaims liability resulting therefrom.

Liability Disclaimer: Zebra Technologies takes steps to ensure that its published Engineering specifications and manuals are correct; however, errors do occur. Zebra Technologies reserves the right to correct any such errors and disclaims liability resulting therefrom.

Limitation of Liability: In no event shall Zebra Technologies or anyone else involved in the creation, production, or delivery of the accompanying product (including hardware and software) be liable for any damages whatsoever (including, without limitation, consequential damages including loss of business profits, business interruption, or loss of business information) arising out of the use of, the results of use of, or inability to use such product, even if Zebra Technologies has been advised of the possibility of such damages. Some jurisdictions do not allow the exclusion or limitation of incidental or consequential damages, so the above limitation or exclusion may not apply to you.

“Made for iPod”, “Made for iPhone”, and “Made for iPad” mean that an electronic accessory has been designed to connect specifically to iPod, iPhone, or iPad, respectively, and has been certified by the developer to meet Apple performance standards. Apple is not responsible for the operation of this device or its compliance with safety and regulatory standards. Please note that the use of this accessory with iPod, iPhone, or iPad may affect wireless performance.

Bluetooth® is a registered trademark of the Bluetooth SIG.

© 1996–2009, QNX Software Systems GmbH & Co. KG. All rights reserved. Published under license by QNX Software Systems Co.

All other brand names, product names, or trademarks belong to their respective holders.
©2019 Zebra Technologies Corporation

Works with:



Windows



Certified by:



(with soft case)

Document Conventions

The following graphic icons are used throughout the documentation set. These icons and their associated meanings are described below.



Caution • Warns you of the potential for electrostatic discharge.



Caution • Warns you of a potential electric shock situation.



Caution • Warns you of a situation where excessive heat could cause a burn



Caution • Advises you that failure to take or avoid a specific action could result in physical harm to you.



Caution • Advises you that failure to take or avoid a specific action could result in physical harm to the hardware.



Important • Advises you of information that is essential to complete a task.



Note • Indicates neutral or positive information that emphasizes or supplements important points of the main text.

Introduction to the ZQ210 Printer

This user guide gives you the information you will need to operate the ZQ210 Mobile Printer. The printer uses some of the latest technologies such as USB charging (Type-C connector), an embedded Dual Mode Bluetooth 2.1 + EDR/4.1 Low Energy module, Near Field Communication (NFC) and Made for iPhone® (MFi). MFi printers provide Apple co-processor (MFi) support which allows an Apple device such as an iPhone or iPad® to authenticate and connect over Bluetooth®.



This printer uses CPCL programming language. To create and print labels using this language, refer to the Programming Guide for CPCL (p/n P1073699-001). See “Appendix G” on page 62 for instructions on how to access manuals on zebra.com.

ZQ210 Software Utilities:

- ZebraNet Bridge Enterprise™: printer configuration, fleet management
- Zebra Setup Utility: single printer configuration, quick setup
- ZebraDesigner Pro v2: label design
- ZebraDesigner Drivers: Windows® driver
- OPOS Driver: Windows driver
- Legacy SDK (part of Multiplatform SDK that supports limited legacy features.)

These utilities can be found on the Zebra website at <http://www.zebra.com/support>. (See “Appendix G” on page 62.)

Unpacking and Inspection

- Check all exterior surfaces for damage.
- Open the media cover (see “[Loading Media Procedure](#)” on page 22) and inspect the media compartment for damage.

In case shipping is required, save the carton and all packing material.



Reporting Damage

If you discover shipping damage:

- Immediately notify and file a damage report with the shipping company. Zebra Technologies Corporation is not responsible for any damage incurred during shipment of the printer and will not cover the repair of this damage under its warranty policy.
- Keep the carton and all packing material for inspection.
- Notify your authorized Zebra re-seller.

ZQ210 Technology

The ZQ210 printer uses several technologies made popular in other Zebra Mobile Printer product lines, as well as newer, state-of-the-art technologies.

Battery

The printer uses a 1500mAh 2-cell Li-Ion battery pack (p/n BTRY-MPV-15MA1-01) with a charge time of under 3.5 hours (at $<23^{\circ}\text{C} \pm 5$ while the printer is off) using a 10W USB charger or cigarette-to-USB adapter. The battery allows the printers to print reliably without recharge for three (3) work days under the following conditions: 25 stops per day and will power up the device 25 times per day; up to 600 2"x6" receipt form, 13% density via USB communication, and up to 500 2"x6" receipt form, 13% density via BT communication.

Operating Temperature	Charging Temperature	Storage Temperature
-20°C to +50°C (-4°F to 122°F) Linered	0°C to +45°C (32°F to 113°F)	-25°C to +60°C (-13°F to 140°F)
-20°C to +38°C (-4°F to 100.4°F) Linerless		



The ZQ210 printer will only function properly with genuine Zebra battery packs.



Note • Power down the printer before removing the battery to minimize the risk of corruption.

Printing Technology

The ZQ210 printer uses the Direct Thermal method to print human-readable text, graphics, and barcodes. It incorporates a sophisticated print engine for optimal printing under all operational conditions. Direct thermal printing uses heat to cause a chemical reaction on specially treated media. This reaction creates a dark mark wherever a heated element on the printhead comes in contact with the media. Because the printing elements are arranged very densely at 203 dpi (dots per inch) horizontal and 200 dpi vertical, highly legible characters and graphic elements may be created a row at a time as the media is advanced past the printhead. This technology has the advantage of simplicity, as there is no requirement for consumable supplies such as ink or toner. However, because the media is sensitive to heat, it will gradually lose legibility over long periods of time, especially if exposed to environments with relatively high temperatures or in direct sunlight.

QR Code

The QR barcode includes human readable text URL, for example www.zebra.com/ZQ210-info, which links the user to printer information and short videos on topics such as buying supplies, features overview, loading media, printing a configuration report, cleaning instructions, and accessory information.

Figure 1 • QR Code

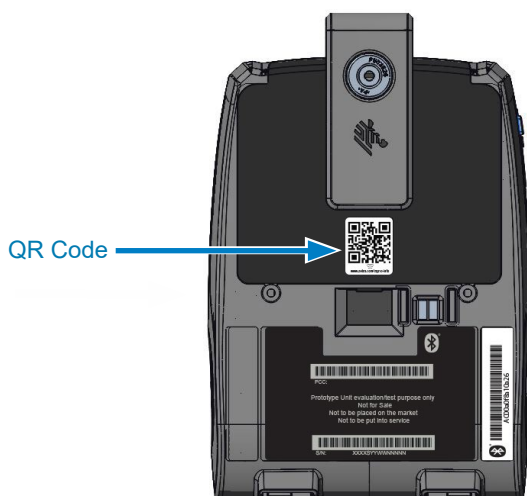

Made for iPhone (MFi)

The ZQ210 printer supports communication with Apple devices running iOS 10 or later over a standalone Bluetooth 4.1 radio.



Near Field Communication (NFC)

The printer supports a passive NFC tag which complies with the “Android Standard Tag format” because Android devices are the most common found on the market today. The NFC tag is programmed from the factory and supports Bluetooth pairing to enable a tablet, smartphone, or terminal to automatically pair with the printer via a Bluetooth connection (within the bounds of the security profile being used).

The NFC tag also supports app launching whereby an app developed either by Zebra or a third party will launch on an NFC-enabled smartphone, tablet or terminal. Similarly, the NFC tag enables launching to a web support page via a tablet, smartphone, or terminal.

Printer Overview

Figure 2 • Overview of Features

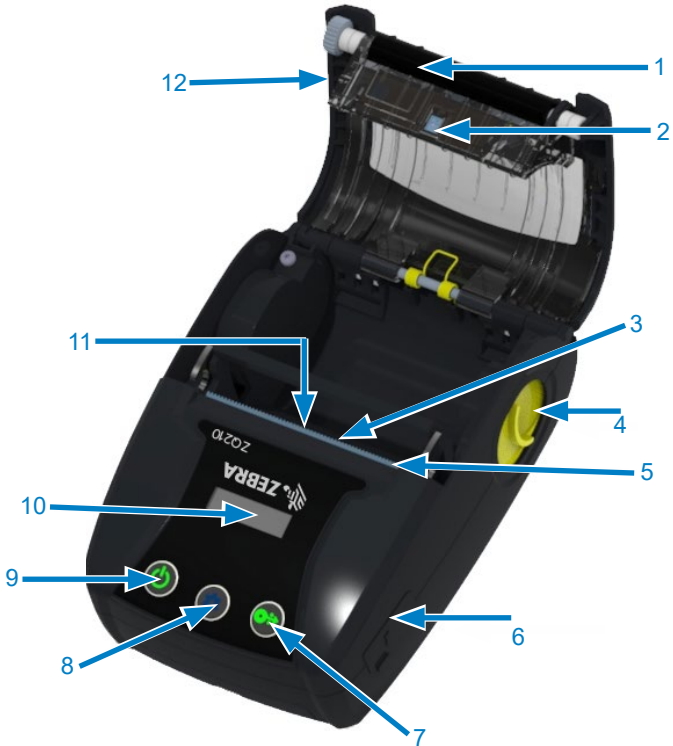

- 1. Platen Roller
- 2. Black Bar Sensor
- 3. Gap Sensor
- 4. Latch Release Lever
- 5. Tear Bar
- 6. USB Port
- 7. Feed Button
- 8. Configure Button
- 9. Power Button
- 10. LCD Display
- 11. Printhead
- 12. Media Cover

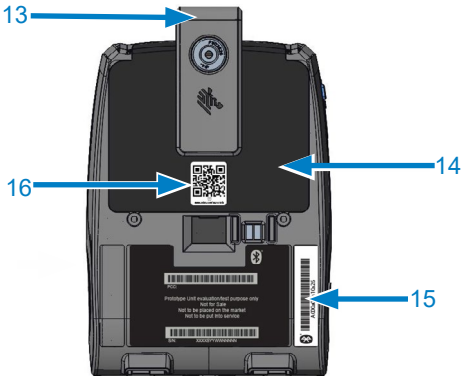

- 13. Belt Clip
- 14. Battery
- 15. MAC Address Label
- 16. QR Code
- 17. Print Touch Icon (Pg. 14)



Note • Scanning the QR code with a smartphone will provide printer specific information at www.zebra.com/ZQ210-info.



Note • Tapping the Zebra Print Touch™ icon with a Near Field Communication (NFC) enabled smartphone will provide instant access to printer-specific information. For more information about NFC and Zebra products, go to <http://www.zebra.com/nfc>. Bluetooth pairing applications via NFC is also possible. See the Zebra Legacy SDK for more information.



Getting Ready to Print

Battery

Installing/Removing Battery



Important • Batteries are shipped with a 70% State of Charge (SOC) which allows for immediate use of the printer before having to charge the battery.

Removing the Battery

1. Use a #1 Phillips driver (with or without the belt clip present) to remove the screw on the battery compartment cover where indicated.



2. Remove the battery compartment cover (and belt clip if applicable) to expose the battery.

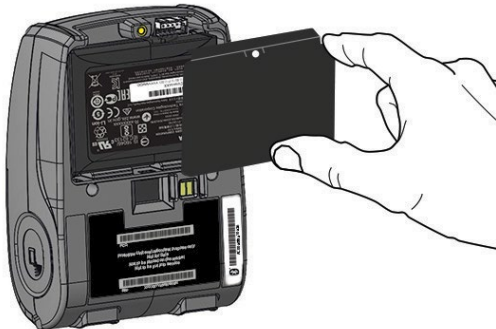

3. Unplug the 5-pin connector and lift the battery pack from the printer.

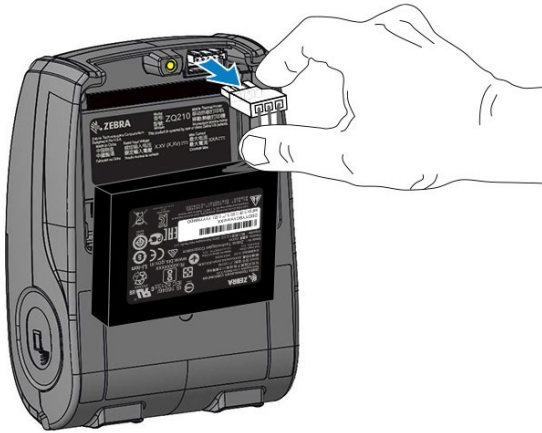

Caution • Battery can explode, leak or catch fire if improperly charged or exposed to high temperature. Do not disassemble, crush, puncture, short external contacts or dispose of in fire or water. Charge on a Zebra approved Lithium-Ion charger only.

Installing the Battery

1. Locate the battery compartment on the bottom of the printer.
2. Plug in the 5-pin connector and insert the battery in the battery compartment.

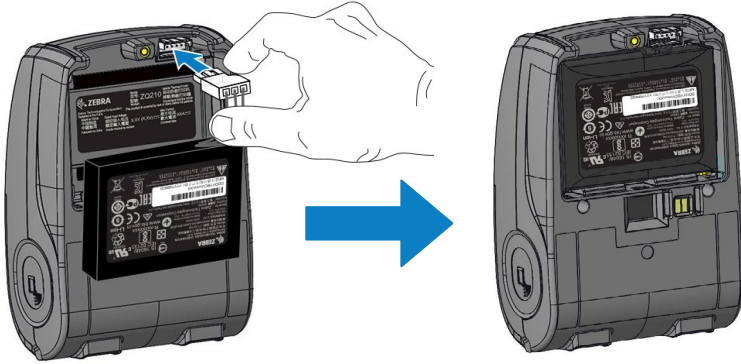

3. Insert the battery compartment cover over the battery. Secure the cover with the screw and a #1 Phillips driver. (If also using a belt clip, thread the screw through the belt clip and the cover to secure.)

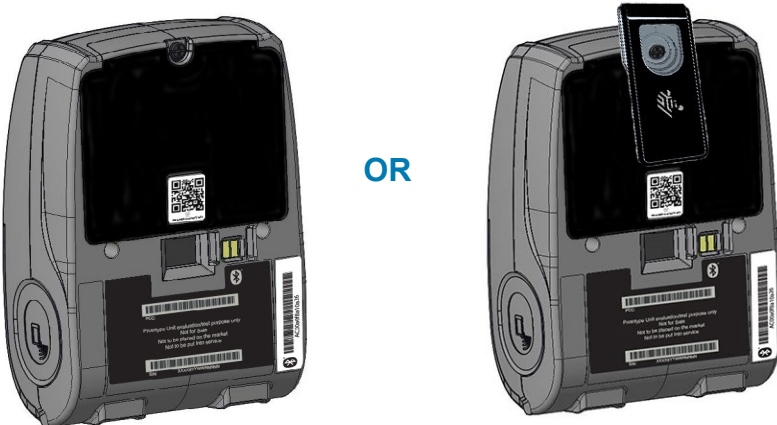

Battery Safety



Caution • Avoid accidental short circuiting of any battery. Allowing battery terminals to contact conductive material will create a short circuit, which could cause burns and other injuries or could start a fire.



Important • Always refer to the Important Safety Information data sheet shipped with each printer and the Technical Bulletin shipped with each battery pack. These documents detail procedures to ensure maximum reliability and safety while using this printer.



Important • Always dispose of used batteries properly. See “[Appendix E](#)” on [page 60](#) for more battery recycling information.



Caution • Use of any charger not approved specifically by Zebra for use with its batteries could cause damage to the battery pack or the printer and will void the warranty.



Caution • Do not incinerate, disassemble, short circuit, or expose to temperatures higher than 60°C (140°F).

Charger Safety



Do not place any charger in locations where liquids or metallic objects may be dropped into the charging bays.

Charging the Battery

AC-to-USB Charger



Important • You must charge the battery fully before using the printer for the first time.

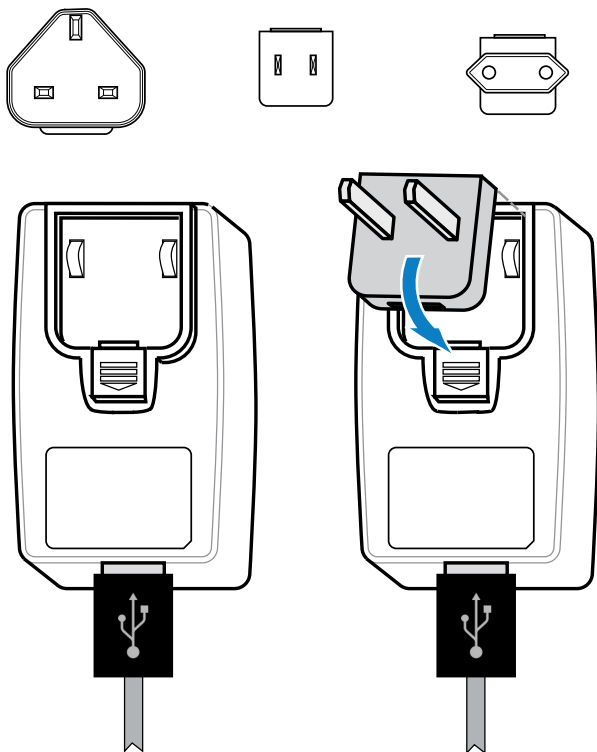

Install the adapter plug into the Power Supply by hooking the top edge into the adapter's receptacle cavity and rotating it until it snaps into place.



Note • Verify that the adapter plug shipped with your printer is the correct one for your region.



Note • Batteries that have reached partial charge capacity may be used. However, it is recommended that you allow the batteries to reach a full charge to maintain maximum battery life.

AC-to-USB Charger (cont.)

1. Connect the male end of the AC-to-USB adapter into an appropriate power outlet using the appropriate plug for your region.
2. Connect one end of the USB charging cable to the adapter (as shown).



3. Rotate the rubber door on the side of the printer to access the USB port.

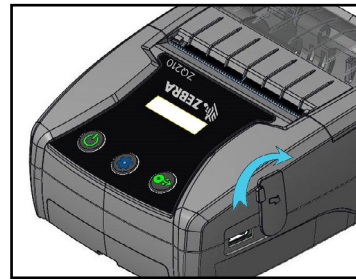

4. Connect the other end of the USB cable to the port on the side of the printer.
5. The printer will power-on and begin charging.

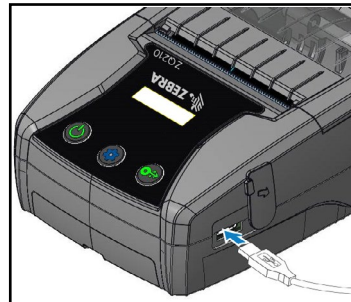

5-Bay Docking Cradle

Use Case: Settlement Room

The ZQ210 5-Bay Docking Cradle is designed to dock and charge up to five (5) printers simultaneously. The 5-bay cradle is beneficial for use in settlement rooms where space and electrical outlets are at a premium and charging in volume is critical. The 5-bay cradle charges the printer from empty to full in less than four (4) hours (at $<23^{\circ}\text{C} \pm 5$ while the printer is off). The user is allowed to operate the printer during charging, although the media compartment is not accessible while the printer is docked.

1. Insert the docking cutouts on the back of the printer onto the posts of the docking cradle.

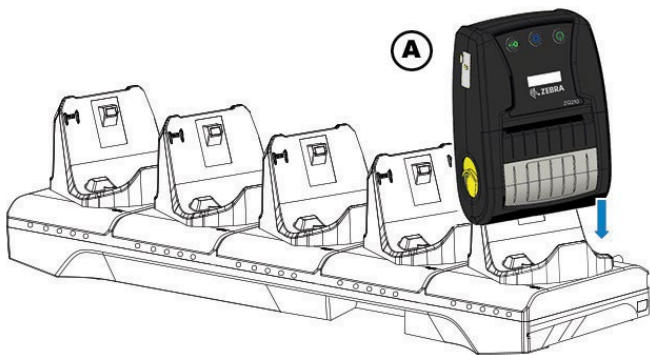

2. Rotate the printer back so the metal plate on the bottom of the printer connects with the magnet on the cradle.

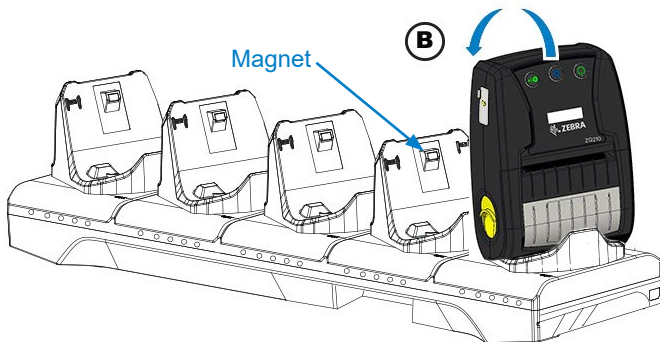

Loading Media in the Printer

Loading Media Procedure

Press the Latch Release Lever on the side of the printer as shown in “1” below. The Media Cover will open automatically.

Rotate the Media Cover back completely as shown in “2”, exposing the media compartment.

Figure 3 • Opening the Printer



Note • The printers also have the option to use media spacers (p/n KIT-MPV-MD2SPR1-05), which are placed in the media compartment and allow the printer to accept 49.5 mm (1.95 in.), 40 mm (1.57 in.) and 30 mm (1.18 in.) wide paper.

Insert the roll of media (in the orientation shown) in the media compartment. The media roll will be able to spin freely inside the media compartment.

Figure 4 • Loading Media (cont.)



Close the media cover as shown below and the paper will advance through the paper path.

Figure 5 • Loading Media (cont.)



Note • Please refer to the Programming Guide (P1099958-001) for information on changing the setting to adjust the media feed length via a Set-Get-Do (SGD).

Operator Controls

The ZQ210 printer comes equipped with a three-button user interface for menu navigation (see “[Figure 6 • Control Panel](#)” on [page 24](#)). The printer also features an OLED display that stays lit while the printer is powered on to indicate to the user that the printer is on.

Standard User Controls

The standard controls have three (3) buttons that perform the following user functions.

- The Power Button turns the printer on and off.
- The Media Feed Button advances a length of media, which is determined by the type of media being used. Label media will be advanced to the next gap or bar sense marker. Journal (plain) media will be advanced by a length determined by the printer’s software. When in Configuration Screen mode, the Feed Button may be used to select a function highlighted on the display.
- The Configuration Button allows the user to scroll between functions on the display.

Figure 6 • Control Panel



Power Button

Press to turn unit on.
Printer boots up in approx. 1 second.
Press for 5 seconds to turn unit off.

Configuration Button

Press to alter printer parameters, print a configuration report or dismiss an acknowledged message.

Media Feed Button

Press to advance a blank label or a software-determined length of journal media.
Press to navigate while in Configuration Screen mode.

OLED Control Panel

The OLED control panel allows the user to view content in one of three modes: *Operation Screen mode*; *Information Screen mode*; and *Configuration Screen mode*. The default mode, which the user sees upon powering up the printer, is Operation Screen mode. This mode is the display shown when the printer is idle, printing and/or receiving data and has no need to convey information beyond icons shown on the display. The OLED can display up to five (5) status icons, including Status, Media, Data, Bluetooth and Battery.

- **Status Icons:** Convey the following printer status conditions:

Ready : Indicates printer is fully operational.

Warning : Indicates there is a condition the user should be aware of but the printer is still functional.

Error : Indicates there is something wrong with the printer that prevents some basic functionality from being used.

- **Media Icon:** Conveys information about the printer's media.

Media Present : Media is loaded and ready to print.

Media Out : No media loaded in the printer.

Door Open : Media cover is unlatched.

- **Data Icons:**

: Printer is not receiving data.

: Printer is receiving data.

- **Bluetooth Icon:** Determines the state of the Bluetooth radio.

Connected: 

Disconnected: No icon

- **Battery Icon:** Displays battery charge status.

Battery Level : 0 to 4 bars.

Battery Level while charging : 0 to 4 bars with lightning bolt.

Power from USB : Battery with USB icon inside.

Battery Low: Battery icon with zero bars.

Charge Error : Battery with error icon inside.

Information Screen

The Information Screen is displayed when text must be used to convey information to the user. The display is split into two viewing areas: The top portion will display the same icons previously described on the Operation Screen; the bottom portion will display text messages. There are two (2) types of messages that can be displayed on the Information Screen as described below.

1. **Timed Messages:** These messages will appear for a specific period of time, and then be removed. For example, after powering up the printer and the printer is ready to print, the message “PRINTER READY” will appear for 30 seconds.



2. **User Activity Messages:** These messages require that the user performs a needed action. For example, when the printer is out of media, a “MEDIA OUT” message will be displayed until new media is loaded in the printer. The Ready ✓ is replaced by the Error ! .



The following User Activity Messages are supported by the printer:

DOWNLOAD FW	HEAD UNDERTEMP
DOWNLOAD FAILED	BATTERY TOO LOW
PAIRING: 123456	MEDIA OUT
PAIRING ONGOING	HEAD OPEN
PAIRING ACCEPTED	CHARGE ERROR
PAIRING REJECTED	NO PRINTING
PAIRING FAILED	BATTERY LOW
PAIRING SUCCESS	PRINTER READY
HEAD OVERTEMP	

When the Information Screen is used to display text messages, it replaces the Operation Screen. When the text message has been acknowledged, the printer will return to the Operation Screen.

Configuration Screen







The Configuration Screen is used as a means to alter printer parameters or initiate printing a configuration label. Specifically, the user will be able to change the following parameters.

- *Darkness*. The user can increase or decrease the darkness by pressing the Media Feed button.
- *Power Up*. The user can select either Feed On or Feed Off by pressing the Media Feed button.
- *Head Close*: The user can select either Feed On or Feed Off by pressing the Media Feed button.
- *Print*: The user can print a configuration report by pressing the Media Feed button.
- *MAC Address*: The user can select either Display On or Display Off by pressing the Media Feed button.
- *Exit Configuration*: The user can exit the Configuration Screen and return to the Operation Screen by pressing the Media Feed button.

Buttons

The user has the ability to use the printer's multi-button interface to run the following power-up and runtime sequences.

Power-Up Sequences

Seq. #	Function	Keys	Button
1	Two Key Report	Hold down Feed button while pressing and releasing the Power Button	 
2	Forced Download	Hold down the Configuration and Feed buttons while pressing Power Button	  
3	Turn printer On or Off	Power button	
4	Force Hard Reset	Hold down Power button longer than 10 sec.	

Verify the Printer is Working

Before you connect the printer to your computer or portable data terminal, make sure that the printer is in proper working order. You can do this by printing a configuration label using the “two key” method. If you can't get this label to print, refer to [“Troubleshooting Topics” on page 46](#).

Printing a Configuration Report

1. Turn the printer off. Load the media compartment with journal media (media with no black bars or gaps on the back).
2. Press and hold the Feed Button.
3. Press and release the Power button and keep the Feed button pressed. When printing starts, release the Feed button. The unit will print a line of interlocking “x” characters to ensure all elements of the print head are working, print out the version of software loaded in the printer, and then print the report.

You can also print a configuration report by turning the printer on, pressing the Configuration button multiple times until you get to the SETTINGS-PRINT screen, and then pressing the Media Feed button to print the report.

The report indicates model, serial number, baud rate, and more detailed information on the printer's configuration and parameter settings. (See “[Troubleshooting Tests](#)” on page 48 for sample printouts and a further discussion on how to use the configuration label as a diagnostic tool.)

Connecting the Printer

The printer must establish communications with a host terminal, which sends the data to be printed. Communications occur in four (4) basic ways:

- Via a cable using USB 2.0 protocols. Windows drivers that support printing via Serial, USB, and the network are included in the Zebra Designer Driver which can be downloaded from www.zebra.com/drivers.
- Via Bluetooth short range radio frequency link.
- Via WinMobile®, Blackberry®, and Android® devices using standard Bluetooth protocol.
- Via Bluetooth to an Apple® iOS device.



Communication to the Printer



Caution • The printer should be turned off before connecting or disconnecting a communications cable.

The standard cable connection for the printers is a USB 2.0 communication and charging cable. One end of the cable has a USB Type-A connector while the other end is USB Type-C.

USB Communications

The small Type C connector on the USB cable plugs into the printer. The connector is not keyed and therefore can be plugged in in either direction. However, do not try to force the cable if it does not plug in. The Type A end of the cable must be plugged into any USB 2.0 host port. The printers utilize the USB cable to charge the printer (see “[AC-to-USB Charger \(cont.\)](#)” on page 20) and for communications between the printer and computer.

Figure 7 • USB Cable Communication with PC

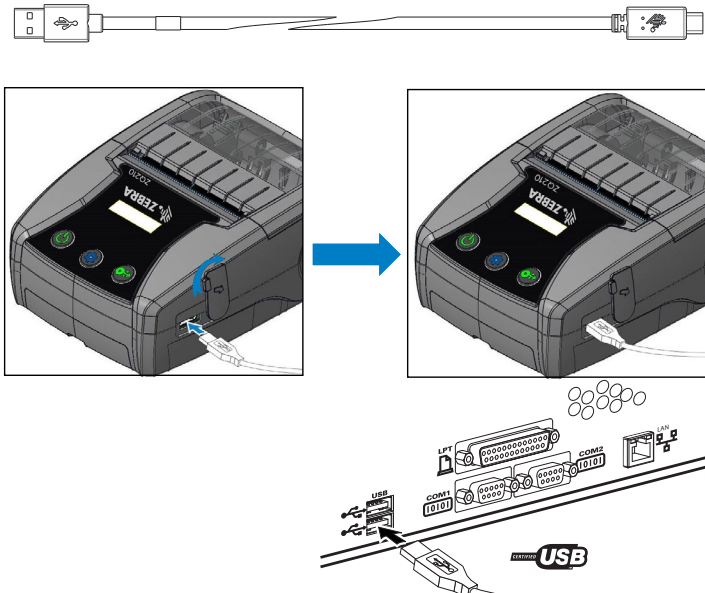

ZebraDesigner uses Windows drivers that support printing via USB and the network. Other terminals or communications devices may require the installation of special drivers to use the USB connection.

Zebra Setup Utilities

Before you start to configure your printer for use on a Local Area Network (LAN), you will need some basic information that will enable you to establish the network configuration for your printer. Zebra Setup Utilities (ZSU) provides a quick and easy way to configure your printers for a variety of purposes, including setting them up for wireless communications either on a LAN or using the international Bluetooth™ communications standard.

Download and install ZSU on your computer. Then attach the USB cable to the printer and computer as shown in Figure 6. Refer to Wireless Configuration Guide (p/n P1048352-001) to follow the steps necessary for setting up and configuring your printer via ZSU.

Go to <https://www.zebra.com/us/en/support-downloads.html> to download ZSU and the Wireless Configuration Guide. (See “Appendix G” on page 62 for details on navigating zebra.com.)

Wireless Communications with Bluetooth

Bluetooth is a worldwide standard for the exchange of data between two devices via radio frequencies. This form of point-to-point communication does not require access points or other infrastructure. Bluetooth radios are relatively low powered to help prevent interference with other devices running at similar radio frequencies. This limits the range of a Bluetooth device to about 10 meters (32 feet). The default for the printers is Class 2. Both the printer and the device it communicates with must follow the Bluetooth standard.

Bluetooth Networking Overview

Each Bluetooth enabled printer is identified by a unique Bluetooth Device Address (BDADDR). This address resembles a MAC address whereby the first three bytes are vendor, and the last three bytes are device (e.g. 00:22:58:3C:B8:CB). This address is labeled on the back of the printer via a barcode for ease of pairing (see “Figure 8 • BT Communications” on page 34). In order to exchange data, two Bluetooth enabled devices must establish a connection. Bluetooth software is always running in the background, ready to respond to connection requests. One device (known as the client) must request/initiate a connection with another. The second device (the server) then accepts or rejects

the connection. A Bluetooth enabled printer will normally act as a peripheral creating a miniature network with the terminal sometimes referred to as a “piconet”. Discovery identifies Bluetooth devices that are available for pairing whereby the central device broadcasts a discovery request and devices respond. If a device is not discoverable, the central cannot pair unless it knows the BDADDR or has previously paired with the device. If both devices support Bluetooth 2.1 or higher they will use Security Level 4 Secure Simple Pairing (SSP), a mandatory security architecture that features two (2) association models: Numeric Comparison and Just Works (no user confirmation).

Bluetooth Security Modes

<p>Security Mode 1</p> <p>If a BT \geq 2.1 device is pairing with a BT \leq 2.0 device, it falls back to BT 2.0 compatibility mode and behaves the same as BT 2.0. If both devices are BT \geq 2.1, Secure Simple Pairing must be used according to the BT spec.</p>	<p>Security Mode 2</p> <p>If a BT \geq 2.1 device is pairing with a BT \leq 2.0 device, it falls back to BT 2.0 compatibility mode and behaves the same as BT 2.0. If both devices are BT \geq 2.1, Secure Simple Pairing must be used according to the BT spec.</p>	<p>Security Mode 3</p> <p>If a BT \geq 2.1 device is pairing with a BT \leq 2.0 device, it falls back to BT 2.0 compatibility mode and behaves the same as BT 2.0. If both devices are BT \geq 2.1, Secure Simple Pairing must be used according to the BT spec.</p>
--	--	--

<p align="center">Security Mode 4: Simple Secure Pairing</p> <p>Simple Secure Pairing: a new security architecture introduced supported in BT \geq 2.1. Service-level enforced, similar to mode 2. Mandatory when both devices are BT \geq 2.1. There are four association models currently supported by mode 4. Security requirements for services must be classified as one of the following: authenticated link key required, unauthenticated link key required, or no security required. SSP improves security through the addition of ECDH public key cryptography for protection against passive eavesdropping and man-in-the-middle (MITM) attacks during pairing.</p>
--

Numeric Comparison	Just Works
<p>Designed for situation where both devices are capable of displaying a six-digit number and allowing user to enter “yes” or “no” response. During pairing, user enters “yes” if number displayed on both devices matches to complete pairing. Differs from the use of PINs in legacy (BT \leq 2.0) pairing because the number displayed for comparison is not used for subsequent link key generation, so even if it is viewed or captured by an attacker, it could not be used to determine the resulting link or encryption key.</p>	<p>Designed for situation where one (or both) of the pairing devices has neither a display nor keyboard for entering digits (e.g., Bluetooth headset). It performs authentication step 1 in the same manner as as numeric comparison, but the user cannot verify that both values match, so MITM (man-in-the-middle) protection is not provided. This is the only model in SSP that does not provide authenticated link keys.</p>

Each mode, except for Just Works, has Man-In-The-Middle (MITM) protection, meaning no third device can view the data being passed between the two devices involved. The SSP mode is usually negotiated automatically based on the capabilities of both the central and peripheral. Lower security modes can be disabled via the `bluetooth.minimum_security_mode` SGD. The `bluetooth.minimum_security_mode` SGD sets the lowest security level at which the printer will establish a Bluetooth connection. The printer will always connect at a higher security level if requested by the central device. To change the security mode and security settings in the printers, use Zebra Setup Utilities.

Bluetooth Minimum Security Modes

Set-Get-Do	BT Version of Central Device (>2.1)
<code>bluetooth.minimum_security_mode=1</code>	Secure Simple Pairing Just Works/Numeric Comparison
<code>bluetooth.minimum_security_mode=2</code>	Secure Simple Pairing Just Works/Numeric Comparison
<code>bluetooth.minimum_security_mode=3</code>	Secure Simple Pairing Numeric Comparison
<code>bluetooth.minimum_security_mode=4</code>	Secure Simple Pairing Numeric Comparison
<code>bluetooth.bluetooth_PIN</code>	Not Used

The ZQ210 printer also features bonding for Bluetooth. The printer caches pairing info so devices stay paired through power cycles and disconnects. This eliminates the need to re-pair on every connection establishment.

The `bluetooth.bonding` SGD is on by default.



Note • For detailed information on Bluetooth, please refer to the Bluetooth Wireless User Guide (P1068791-003) at: <http://www.zebra.com/us/en/support-downloads.html>

In addition, the printers support a “scan and pair” function via a handheld device and the MAC Address label on the bottom of the printer (see “[Figure 8 • BT Communications](#)” on page 34). The ZQ210 printer also features passive Near Field Communication (NFC) technology. Using the “Print Touch” feature located on the side of the printer, end users can automatically pair with a handheld device that supports NFC technology. The NFC tag has the printer’s BDADDR encoded in a URL on the tag. Simply touching the NFC handheld device to the “Print Touch” icon on the printer will connect and pair the handheld device to the printer.

Figure 8 • BT Communications



Setting Up the Software

The printer uses Zebra's CPCL Programming language which was designed for mobile printing applications. CPCL is fully described in the CPCL Programming Guide (p/n P1073699-001) available on-line at <https://www.zebra.com/manuals>. You can also use ZebraDesigner Pro v2, Zebra's Windows® based label creation program which uses a graphical interface to create and edit labels in either language. See "Appendix G" on page 62 for tips on downloading the Designer Pro application from Zebra's Web site.

Designing Labels

The following examples provide guidelines for designing labels for the printers, specifically for Gap Media, Black Bar Media and Journal Media. The illustrations for each media type define recommended tolerances, keep-out zones and safe printing zones designed to avoid any vertical registration issues during printing. Dimensions are determined based on product registration capabilities and Zebra-recommended media tolerances.

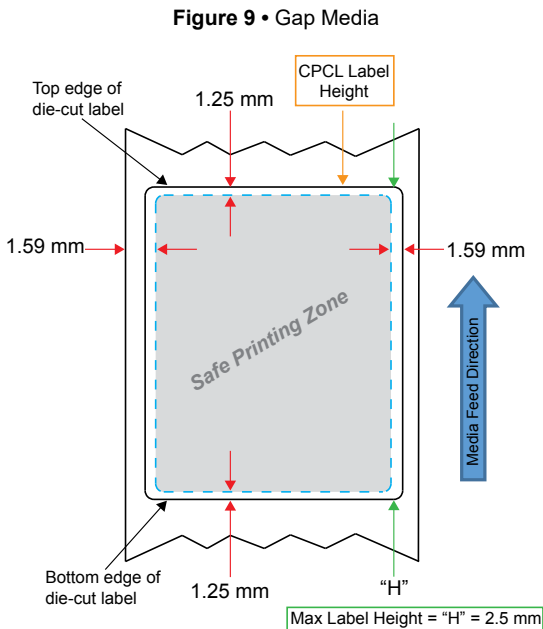

Figure 10 • Journal Media

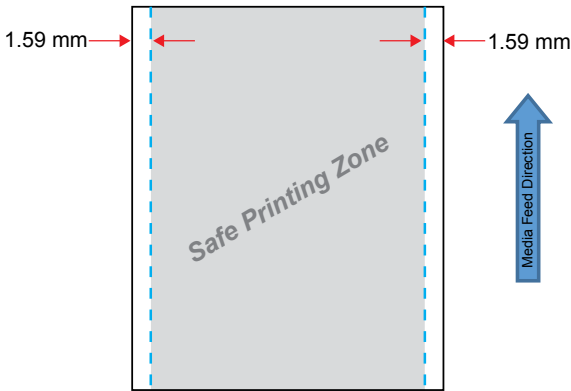
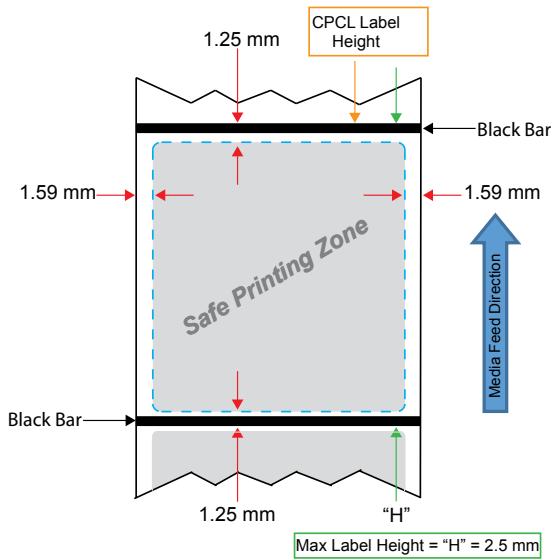

Figure 11 • Black Bar Label Media



Using Pre-Printed Receipt Media

The ZQ210 printer supports alignment of pre-printed receipts by using the out of paper sensor located near the printhead.

Black Mark Dimensions (Receipt Media)

The reflective media black marks (or black bar/marks) should extend past the centerline of the roll on the front side of the paper.

- Minimum mark width: 0.5 in. (12.7 mm) perpendicular to the edge of the media, and centered within the width of the roll.
- Mark length: 0.09 - 0.43 in. (2.4 - 11.0 mm) parallel to the edge of the media.

Label Areas

The media/black bar sensor detects the dark, pre-printed bar on the media, so a path in the center of the paper must be kept free of dark, pre-printed graphics.



Note • Dark, pre-printed graphics refer to any symbols, barcodes, text and/or colored areas that have been applied to the receipt paper rolls before they have ever been used in the printer.

Figure 12 • Label Areas

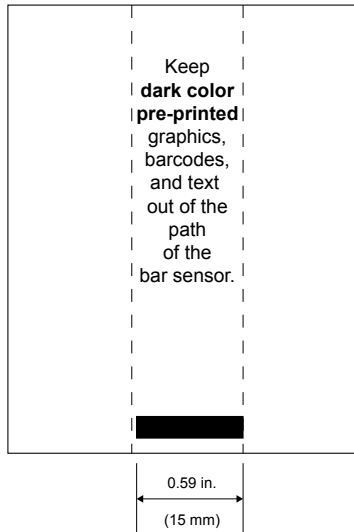

Label Design Examples

This section shows examples of labels with and without problems.

Figure 13 • Label Design Examples

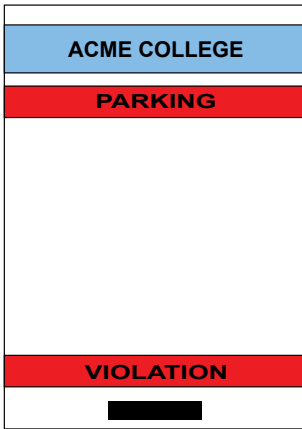

Problem Label Design

The dark color, pre-printed text and graphics are in the path of the black bar at the bottom of the receipt.

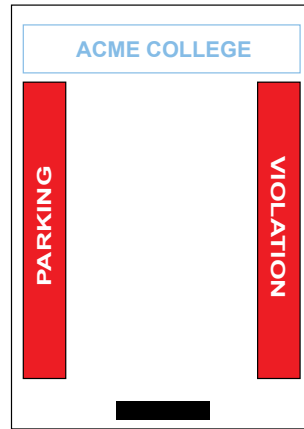

Good Label Design

The center path to the black bar is free of dark color, pre-printed text, and graphics.

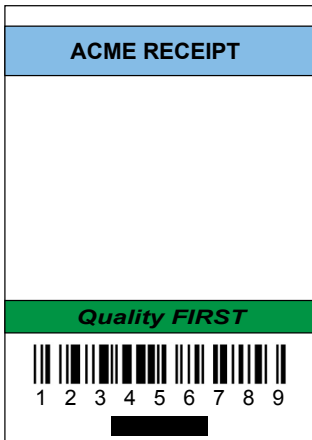

Problem Label Design

The dark color, pre-printed text and graphics are in the path of the black bar at the bottom of the receipt.

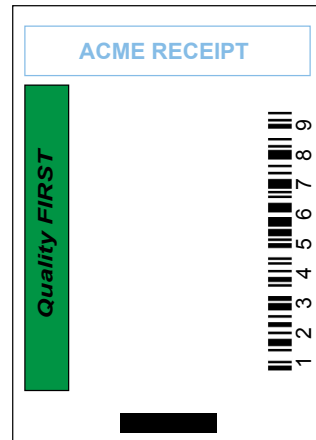

Good Label Design

The center path to the black bar is free of dark color, pre-printed text, and graphics.



Note • Complete information on using pre-printed receipt paper can be found in the FORM command in the CPCL Programming Guide (P1073699-001) at www.zebra.com/manuals.

Keep-Out Areas

At times, incomplete printing of text and/or graphics appear because minimum margins are not provided during label design. The recommended minimum margins, or “keep out areas” are shown in Figure 14.

Figure 14 • Keep Out Areas

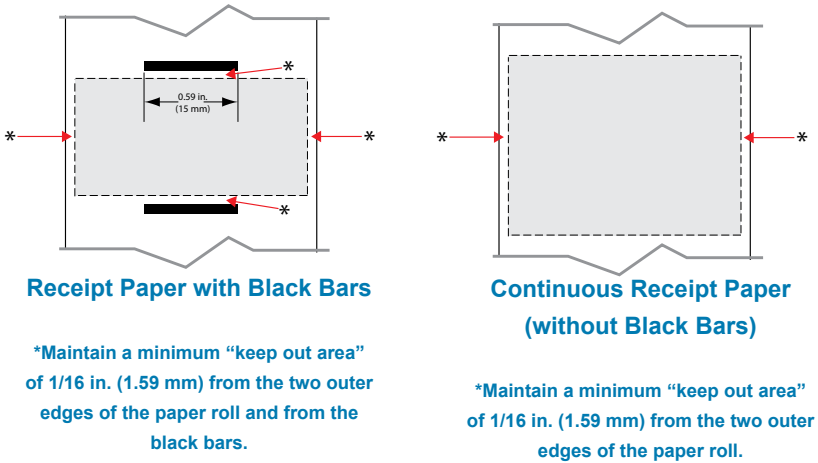

Note • The length of each “continuous” receipt is determined by the data sent to the printer.

Near Field Communication (NFC)

Devices using NFC may be *active* or *passive*. A passive device, such as a ZQ210 printer with an NFC tag, contains information that other devices can read but does not read any information itself. An active device, such as a smartphone, can read the information on the printer’s NFC tag, but the tag itself does nothing except transmit the info to authorized devices.

Figure 15 • Near Field Communication (NFC) Pairing



NFC Use Cases

- *Bluetooth Pairing* – used to cause a tablet, smart phone or terminal to automatically pair with the printer via a Bluetooth connection, within the bounds of the security profile being used. This shall contain the BT address and serial number of the printer.
- *App launching* – used to cause an app, developed either by Zebra or a third party to be executed on a smartphone, tablet or terminal
- *Web site launching* – used to cause a smart phone, tablet or terminal to display a web site developed by Zebra or a third party developer



Note • Tapping the Zebra Print Touch™ icon  with a Near Field Communication (NFC) enabled smartphone will provide instant access to printer-specific information. For more information about NFC and Zebra products, go to <http://www.zebra.com/nfc>. Bluetooth pairing applications via NFC is also possible. Please see Zebra Legacy SDK for more information.

Wearing the Printer

Swivel Belt Clip

The ZQ210 printer has a plastic swivel belt clip included as a standard feature.

To remove the belt clip:

1. Use a #1 Phillips driver to remove the screw on the belt clip.
2. Remove the belt clip.
3. Lift and remove the battery compartment cover.
4. Squeeze lock on the connector to unplug.
5. Lift the battery pack from the printer.

To use the belt clip:

Hook the belt clip over your belt, and ensure that the clip is securely attached to the belt. The belt clip will pivot to allow you to move freely while wearing the printer.

Figure 16 • Printer with Belt Clip

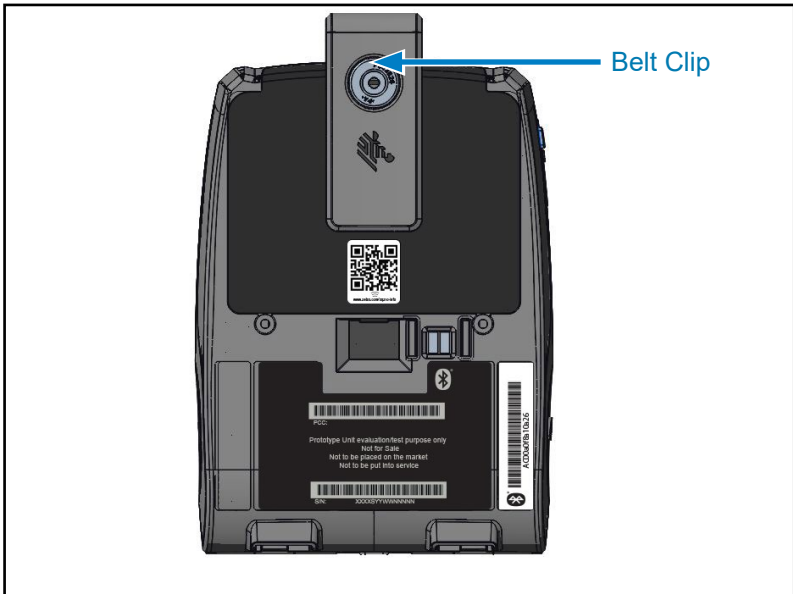

Soft Case

The ZQ210 printer has a soft case option (p/n SG-MPV-SC21-01) that also allows you to carry the printer using a shoulder strap.

Figure 17 • Using the Soft Case



1. Lift up the top flap of the soft case which is secured with Velcro. Insert the printer in the case with the bottom of the printer facing forward in this orientation.



2. Turn the case around to access the LCD display and user controls which are visible through the plastic window. The bottom half of the plastic window can be lifted to access the paper path.



Note • The shoulder strap option (included) can be used with the soft case by securing the ends of the shoulder strap on the two metal rings on the soft case.

Preventive Maintenance

Extending Battery Life

- Never expose the battery to direct sunlight or temperatures over 45° C (113° F) when charging.
- Always use a Zebra charger designed specifically for Lithium-Ion batteries. Use of any other kind of charger may damage the battery.
- Use the correct media for your printing requirements. An authorized Zebra re-seller can help you determine the optimum media for your application.
- If you print the same text or graphic on every label, consider using a pre-printed label.
- Choose the correct print darkness, and print speed for your media.
- Use software handshaking (XON/XOFF) whenever possible.
- Remove the battery if the printer won't be used for a day or more and you're not performing a maintenance charge.
- Consider purchasing an extra battery.
- Remember that any rechargeable battery will lose its ability to maintain a charge over time. It can only be recharged a finite number of times before it must be replaced. Always dispose of batteries properly. Refer to [“Appendix F” on page 61](#) for more information on battery disposal.

General Cleaning Instructions



Caution • Avoid possible personal injury or damage to the printer. Never insert any pointed or sharp objects into the printer. Always turn off the printer before performing any cleaning procedures. Use care when working near the tear bars as the edges are very sharp.



Warning • The printhead can get very hot after prolonged printing. Allow it to cool off before attempting any cleaning procedures.



Only use a Zebra cleaning pen (not supplied with the printer) or a cotton swab with 90% medical grade alcohol for cleaning the printhead.



Caution • Use only cleaning agents specified in the following tables. Zebra Technologies Corporation will not be responsible for damage caused by any other cleaning materials used on this printer.

Cleaning

Area	Method	Interval
Printhead	Use a Zebra cleaning pen to swab the thin gray line on the printhead, cleaning the print elements from the center to the outside edges of the printhead.	After every five rolls of media (or more often, if needed). When using linerless type media, cleaning is required after every roll of media.
Platen Surface (Linered)	Rotate the platen roller and clean it thoroughly with a fiber-free swab, or lint free, clean, damp cloth lightly moistened with medical grade alcohol (90% pure or better) (Figure 18).	After every five rolls of media (or more often, if needed)
Platen Surface (Linerless)	Rotate platen roller and clean with a fiber-free swab and 1 part liquid soap (Palmolive or Dawn) and 25 parts water. Use pure water to clean after soap/water mixture. (Figure 19)	Clean platen only if there is an issue during printing, i.e., media not releasing from the platen. (*See Note below.)
Scraper (Linerless Units Only)	Use adhesive side of media to clean scraper on linerless units. (Figure 19)	After every five rolls of media (or more often, if needed).
Tear Bar	Clean thoroughly with 90% medical grade alcohol and a cotton swab. (Figure 18)	As needed
Printer Exterior	Water-dampened cloth or 90% medical grade alcohol wipe.	As needed
Printer Interior	Gently brush out printer. Ensure the Backside Sensor and Frontside Sensor windows are free of dust. (Figure 18)	As needed
Interior of units with Linerless Platens	Clean thoroughly with 90% medical grade alcohol and a fiber-free swab. (See Figure 19 for specific target areas for interior cleaning.)	After every five rolls of media (or more often, if needed).



Note • This is an emergency procedure only to remove foreign contaminants (oils, dirt) from the platen that can damage the printhead or other printer components. This procedure will shorten or even exhaust the linerless platen's useable life. If the linerless media continues to jam after cleaning and feeding 1 to 2 meters (3 to 5 feet) of media, replace the platen.

Figure 18 • Cleaning (Linered)



Figure 19 • Cleaning (Linerless)

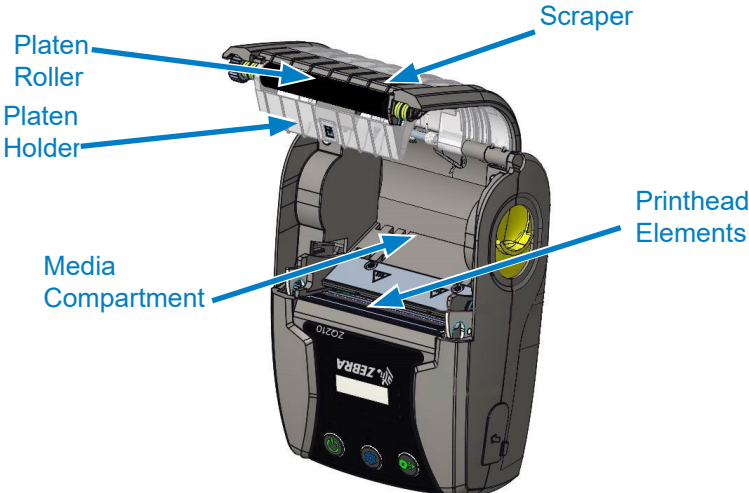

LCD Control Panel Indicators

The printer's display shows several icons which indicate the status of various printer functions (See [“Information Screen” on page 26](#)). Check the indicator status, then refer to the Troubleshooting topic referenced in the chart to resolve the problem.

Troubleshooting Topics

1. *No power:*

- Check that battery is installed properly.
- Recharge or replace battery as necessary.



Caution • Always dispose of batteries properly. Refer to [“Appendix F” on page 61](#) for more information on proper battery disposal.

2. *Media does not feed:*

- Be sure media cover is closed and latched.
- Check media compartment for any binding.
- Ensure most recently printed label is removed (only in peel mode).
- Ensure label sensor is not blocked.

3. *Poor or faded print:*

- Clean printhead.
- Check quality of media.

4. *Partial or missing print:*

- Check media alignment.
- Clean print head.
- Ensure media cover is properly closed and latched.

5. *Garbled print:*

- Check baud rate.

6. *No print:*

- Check baud rate.
- Replace battery.
- Check cable to terminal.
- Invalid label format or command structure. Place printer in Communications Diagnostic (Hex Dump) Mode to diagnose problem.

7. Reduced battery charge life:

- If battery is older than one year, short charge life may be due to normal aging.
- Check battery health.
- Replace battery

8. displayed:

- Data icon is normal while data is being received.

9. or displayed:

- Check that media is loaded and that the media cover is closed and securely latched.

10. Communication error:

- Check baud rate.
- Replace cable to terminal.

11. Label jam:

- Open head release latch and media cover.
- Remove and reinstall media.

12. Skip Labels:

- Check media for top of form sense mark or label gap.
- Check that the maximum print field has not been exceeded on label.
- Ensure bar or gap sensor is not blocked or malfunctioning.

13. Blank LCD screen:

- Make sure printer is turned on.
- No application loaded or application corrupted: reload program.

14. No NFC Connectivity

- Ensure smartphone is positioned 3 inches (7.62 cm) or closer to the Print Touch icon on the side of the printer.

Troubleshooting Tests

Printing a Configuration Label

To print out a listing of the printer's current configuration, follow these steps:

1. Turn the printer off. Load the media compartment with journal media (media with no black bars printed on the back).
2. Press and hold the Feed Button.
3. Press and release the Power button and keep the Feed button pressed. When printing starts, release the Feed button.



Note • The configuration report can also be pressing the Configuration button and navigating to **SETTINGS>PRINT.**

Refer to [“Figure 20 • Configuration Label” on page 50](#) for sample configuration printouts.

Communications Diagnostics

If there is a problem transferring data between the computer and the printer, try putting the printer in the Communications Diagnostics Mode (also referred to as the “DUMP” mode). The printer will print the ASCII characters and their text representation (or the period ‘.’, if not a printable character) for any data received from the host computer.

To enter Communications Diagnostics Mode:

1. Print a configuration label as described above.
2. At the end of the diagnostics report, the printer will print: “Press FEED key to enter DUMP mode”.
3. Press the FEED key. The printer will print: “Entering DUMP mode”.



Note • If the FEED key is not pressed within 3 seconds, the printer will print “DUMP mode not entered” and will resume normal operation.

4. At this point, the printer is in DUMP mode and will print the ASCII hex codes of any data sent to it, and their text representation (or “.” if not a printable character).

Additionally, a file with a “.dmp” extension containing the ASCII information will be created and stored in the printer’s memory. It can be viewed, “cloned” or deleted using the ZebraNet Bridge application. (Refer to the ZebraNet Bridge Enterprise documentation for more information.)

To terminate the Communications Diagnostics Mode and re-turn the printer to normal operations:

1. Turn the printer OFF.
2. Wait 5 seconds.
3. Turn the printer ON.

Contacting Technical Support

If the printer fails to print the configuration label, or you encounter problems not covered in the Troubleshooting Guide, contact Zebra Technical Support. Technical Support addresses and phone numbers for your area can be found in [“Appendix H” on page 64](#) of this manual.

You will need to supply the following information:

- Model number and type (e.g., ZQ210)
- Unit serial number (Found on the large label on the back of the printer, also found in the configuration label printout.)
- Product Configuration Code (PCC) (15 digit number found on the label on the back of the unit)

Figure 20 • Configuration Label

XXXXXXXXXXXXXXXXXXXXXXXXXXXXXXXXXXXX

Zebra ZQ210 V88.01.02P650

Serial Number: XXZSJ182500525

PCC: ZQ21-A0E02KE-00

Name: XXZSJ182500525

Firmware: V88.01.02P650

RAM
Chksum: 3ABC
Build Date May 30 2019
Build Time 08:33:47

Universal Serial Bus:
2.0 Full Speed Device
Manufacturer String: Zebra Technologies
Product String: ZTC ZQ210-203d
pi CPCL
Language: CPCL

Bluetooth:
Bluetooth Spec: 4.1
Firmware: 5.5.3
Date: 10/03/2017
Local Name:
XXZSJ182500525
Discoverable: on
Security Mode: 1
Enable: on
Address: A4:DA:32:83:9A:9C

A4DA32839A9C

Power Management:
In-activity Timeout:0 Secs
Low-battery Timeout:60 Secs
Voltage:8.27VV
Low-bat Warning:7.05V
Low-bat Shut-down:6.85V
Power On Cycles:54

Memory:
Flash :16777215 Bytes
RAM :12517376 Bytes

Label:
Width : 48 mm
Height: 8191 mm

Printhead Test

Identifies Printer as a ZQ210

Printer Serial Number

Firmware Version

Bluetooth™ Radio Address

Flash and RAM Memory Installed

Figure 20a • Configuration Label (cont.)

```
Sensors: (Adj)
Front Bar:2
Head Temperature: 23 C
Voltage:8.27V
Resident Fonts:
Font      Sizes  Chars
-----
0         0- 6   20-FF
1         0      20-80
2         0- 1   20-59
3         0      64-2E
4         0- 7   20-FF
5         0- 3   20-FF
6         0      20-44
7         0- 1   20-FF
      (ICON .CPF) 0
      (GBUNSG16.CPF) 0
      (DEJAVU12.CPF) 0
      (DEJAVU14.CPF) 0
      (DEJAVU16.CPF) 0
      (DEJAVU20.CPF) 0
      (NSMTTC16.CPF) 0
File Directory:
File      Size
-----
INDEX .WML      853
INFO_TIM.WML  426
INFO_ACK.WML  393
CONFIG .WML   2662
ICON .CPF     4999
GBUNSG16.CPF 1420810
DEJAVU12.CPF  5323
DEJAVU14.CPF  7001
DEJAVU16.CPF  8183
DEJAVU20.CPF 10288
NSMTTC16.CPF 909344
2KEY .TXT     1748
9876000 Bytes Free

End of report

Press FEED key to enter
Diagnostics Mode
```

Resident Human Readable Fonts Installed

Files loaded in printer memory (includes pre-scaled or scalable fonts)

Specifications



Note • Printer specifications are subject to change without notice.

Printing Specifications

Parameter	ZQ210
Print Width	Up to 48 mm (1.89 in.)
Print Speed	63.5 mm (2.5 in.) /second (lined) 38.1 mm (1.5 in.) /second (linerless)
Printhead Burn Line to Tear Edge Distance	4.8 mm (0.19 in.) +/- 0.5 mm (0.02 in.)
Printhead Life	390K inches of paper feed MTBF when using Zebra media.
Print Density	203 dots/in. or better

Memory and Communications Specifications

Parameter	ZQ210
Flash Memory	16 MB ¹
SDRAM Memory	16 MB ¹
Wireless Communications	Embedded Dual Mode Bluetooth 2.1+EDR/4.1 Low Energy with integrated antenna and modular certification

1. Memory configuration on your printer may be ascertained by printing a configuration label as detailed on [“Printing a Configuration Label” on page 48](#).

Label Specifications

Parameter	ZQ210
Media Width	Standard: 58 mm +/- 0.75 mm (2.28 in. +/- 0.03 in.) *Optional: 49.5 mm +/- 0.5 mm (1.95 in. +/- 0.02 in.) *Optional: 40 mm +/- 0.65 mm (1.57 in. +/- 0.025 in.) *Optional: 30 mm +/- 0.65 mm (1.18 in. +/- 0.025 in.)
Min/Max Label Length	12.5 mm (0.49 in.) minimum (Unconstrained max length in line print mode)
Black Bar Sensor to Printhead Burnline Distance	16 mm (0.63 in.) +/- 1.0/-0.6mm (0.04/-0.02 in.)
Media Thickness (except Tag)	Linerless: 0.058 to 0.1575 mm (2.28 to 6.2 mils) Linered: 0.053 to 0.1575 mm (2.1 to 6.2 mils)
Max Tag Thickness	0.1397 mm (5.5 mils)
Max Label Roll Outer Diameter	40 mm (1.57 in.)
Inner Core Diameters	Media 3.5 mm or less: 12.7 mm (0.5 in.) Media > 3.5 mm: 22.2 mm (0.875 in.)
Black Mark Location	The reflective media black marks should be centered on media roll
Black Mark Dimensions	Minimum mark width: 12.7 mm (0.5 in.) Mark length: 2.4-11 mm (0.09 to 0.43 in.)



Note • Use Zebra brand direct thermal media that is outside wound. Media may be reflective (black mark) sensing, or transmissive (gap) sensing, die-cut, continuous or linerless. For die-cut labels, use only full auto dies.

* Optional media requires the use of spacers (KIT-MPV-MD3SPR1-5).

Physical, Environmental and Electrical Specifications

Parameter	ZQ210
Weight w/ battery	0.58 lbs. (0.265 kg)
Temperature	Operating: -10 °C to 50 °C (14 °F to 122 °F)
	Storage: -20 °C to 60 °C (-4 °F to 140 °F)
	Charging: 0 °C to 40 °C (32 °F to 104 °F)
Relative Humidity	Operating/Storage: 10% to 90% non-condensing
Battery	2-Cell Battery Lithium-Ion, 7.26 VDC (nominal);
Intrusion Protection (IP) Rating	IP43 (without optional environmental case) IP54 (with optional environmental case)

CPCL Font and Bar Code Specifications and Commands

Standard Fonts	SWIS721.CSF - CPCL scalable font; DEJAVU12.CPF - Pre-Scaled fonts; DEJAVU14.CPF - Pre-Scaled fonts; DEJAVU16.CPF - Pre-Scaled fonts; DEJAVU20.CPF - Pre-Scaled fonts; English/Latin9 built in EZ320; MUTOS16.CPF - Utah, Vietnamese, 16x16 bitmap; CTUNMK24.CPF - M Kai; Traditional Chinese, 24x24 bitmap; NSMTTC16.CPF - New Sans MT; Traditional Chinese, 16x16 bitmap.	
Available Optional Fonts	Optional International character sets: Chinese 16 x 16 (trad), 16 x 16 (simplified), 24 x 24 (simplified); Japanese 16 x 16, 24 x 24	
Linear Bar Codes Available	Barcode (CPCL Command)	
	<p>Codabar (CODABAR, CODABAR 16) UCC/EAN 128 (UCCEAN128) Code 39 (39, 39C, F39, F39C) Code 93 (93) Code 128 (128) EAN 8, 13, 2 and 5 digit extensions (EAN8, EAN82, EAN85, EAN13, EAN132, and EAN135) EAN-8 Composite (EAN8) EAN-13 Composite (EAN13) Plessey (PLESSEY) Interleaved 2 of 5 (I2OF5) MSI (MSI, MS110, MS11110) FIM/POSTNET (FIM) TLC39 (TLC39) UCC Composite A/B/C (128(Auto)) UPCA, 2 and 5 digit extensions (UPCA2 and UPCA5) UPCA Composite (UPCA) UPCE, 2 and 5 digit extensions (UPCE2 and UPCE5) UPCE Composite (UPCE)</p>	
2-D Bar Codes Available	RSS:	<p>Aztec (AZTEC) MaxiCode (MAXICODE) PDF 417 (PDF-417) QR Code (QR) RSS-14 (RSS-Subtype 1) RSS-14 Truncated (RSS-Subtype 2) RSS-14 Stacked (RSS-Subtype 3) RSS-14 Stacked Omnidirectional (RSS-Subtype 4) RSS Limited (RSS-Subtype 5) RSS Expanded (RSS-Subtype 6)</p>
Rotation Angles	0°, 90°, 180°, and 270°	

Figure 21 • Printer Dimensions

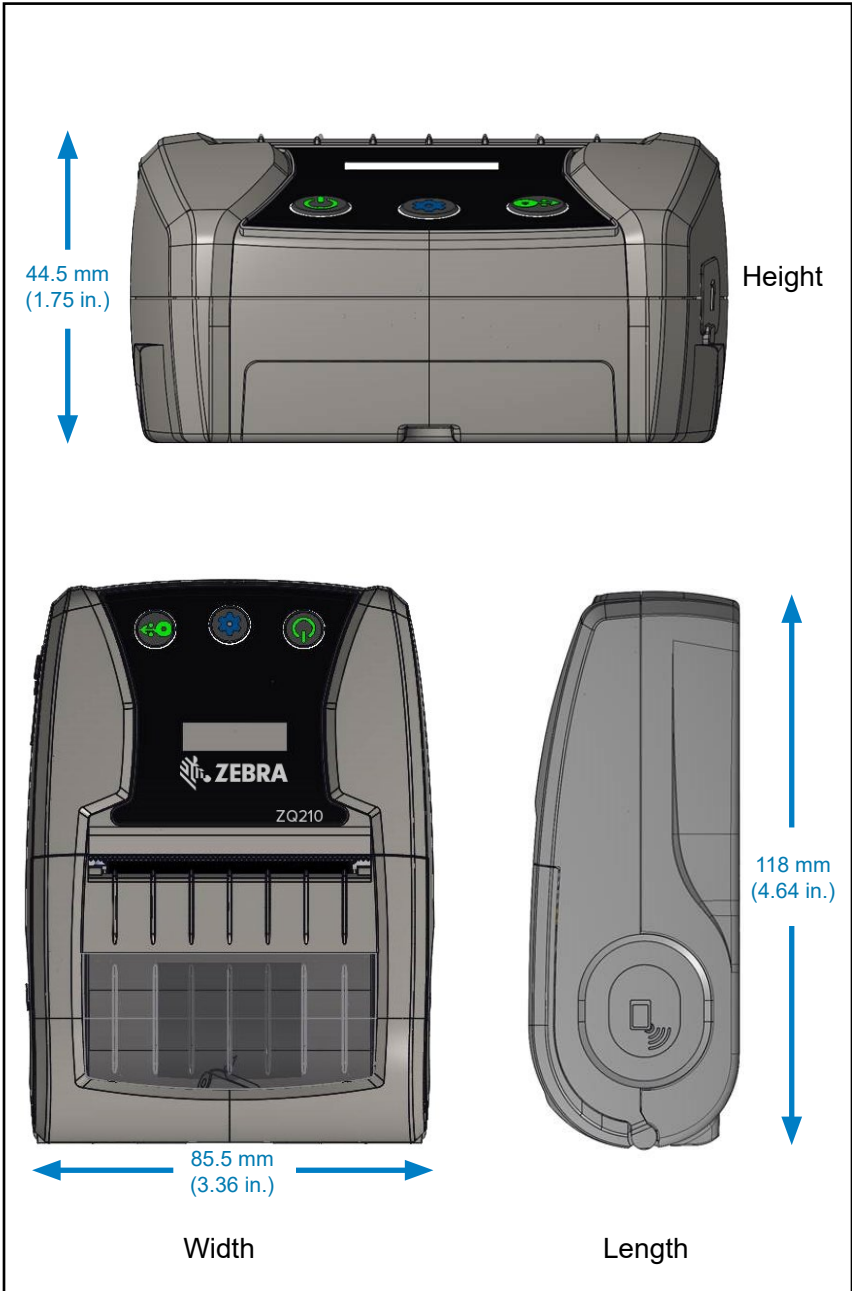

Printer Accessories

Region	Part #	Description
NALA	PWR-WUA5V12W0US	AC to USB Adaptor; ZQ3 (US)
EU	PWR-WUA5V12W0GB	AC to USB Adaptor; ZQ3 (UK)
EU	PWR-WUA5V12W0EU	AC to USB Adaptor; ZQ3 (EU)
LA	PWR-WUA5V12W0BR	AC to USB Adaptor; ZQ3 (BR)
AP	PWR-WUA5V12W0IN	AC to USB Adaptor; ZQ3 (IN)
WW	CHG-AUTO-USB1-01	Cigarette to USB Adapter; ZQ3
WW	MNT-MPV-VHD21-01	Vehicle holder (dashboard), ZQ210/ZQ112/ZR118
WW	BTRY-MPV-15MA1-01	Spare 1500mAh battery for ZQ210/ZQ112/ZR118
WW	KIT-MPV-MD2SPR1-05	Media spacers for ZQ210/ZQ112/ZR118 (5 sets; 2 per set)
WW	SG-MPV-SC21-01	Kit, Soft case/Shoulder Strap ZQ210/ZQ112/ZR118
WW	KIT-MPV-BLTCP21-05	Belt Clip for ZQ210/ZQ112/ZR118 Series, Qty. 5
LA	CRD-MPV-5SC2BR1-01	5-slot docking cradle, ZQ210 (BR)
EU	CRD-MPV-5SC2EU1-01	5-slot docking cradle, ZQ210 (EU)
EU	CRD-MPV-5SC2UK1-01	5-slot docking cradle, ZQ210 (UK)
NA	CRD-MPV-5SC2US1-01	5-slot docking cradle, ZQ210 (US)
WW	CBL-MPV-USB1-01	USB Cable (Type A to Type C), QTY1
WW	CBL-MPV-USB1-05	USB Cable (Type A to Type C), QTY5
WW	SG-MPV-SDSTP1-01	Shoulder Strap ZQ220/ZQ120/ZR138



Note • For more information on Zebra accessories, go to <https://www.zebra.com/us/en/products/accessories/printer-print-engine.html>.



Note • Refer to “Appendix A” on page 57 for additional information on Data I/O cables.

USB Cables

Part Numbers P1081545; ASSY,CABLE,USB A TO C

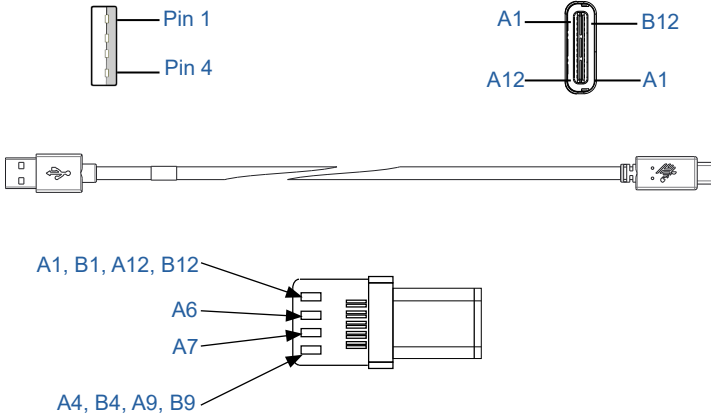

Type-C Plug		Wire		Type-A Plug	
Pin #	Signal Name	Wire #	Signal Name	Pin #	Signal Name
A1,B1, A12,B12	GND	1	GND_PWrt1	4	GND
A4,B4,A9, B9	VBUS	2	PWR_VBUS1	1	VBUS
A5	CC	See Note 1			
B5	VCONN				
A6	Dp1	3	UTP_Dp	3	D+
A7	Dn1	4	UTP_Dn	2	D-
	Shield	Braid	Shield	Shell	Shield

Notes:

1. Pin A5 (CC) of the USB Type-C plug shall be connected to VBUS through resistor Rp (56 kΩ +/- 5%).
2. Contacts B6 and B7 should not be present in the USB Type-C plug.
3. All VBUS pins shall be connected together within the USB Type-C plug. Bypass capacitors are not required for the VBUS pins in this cable.
4. All ground return pins shall be connected together within the USB Tupe-C plug.
5. Shield and GND grounds shall be connected within the USB Type-C and USB 2.0 Standard-A plugs on both ends of the cable assembly.
6. All UsB Type-C plug pins that are not listed in this table shall be open (not connected).

Appendix B

Media Supplies

To insure maximum printer life and consistent print quality and performance for your individual application, it is recommended that only media produced by Zebra be used.

Advantages include:

- Consistent quality and reliability of media products.
- Large range of stocked and standard formats.
- In-house custom format design service.
- Large production capacity which services the needs of many large and small media consumers including major retail chains world wide.
- Media products that meet or exceed industry standards.

For more information go the Zebra website (www.zebra.com) and select the Products tab.

Appendix C

Maintenance Supplies

In addition to using quality media provided by Zebra, it is recommended that the printer be cleaned as prescribed in “Cleaning” on page 44. The following item is available for this purpose:

- Cleaning Pen (12 pack): p/n 105950-035

Serial and PCC Number Locations

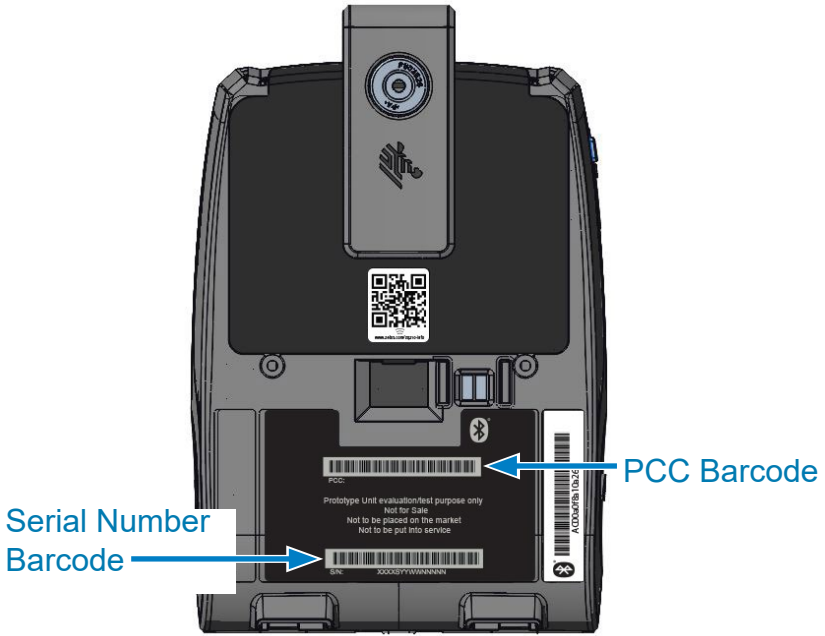

Important • Due to compliance and customs restraints, an integrator may not be able to ship a printer purchased in one country to another country based on the limitations imposed by regional SKUs. The country code identified in the printer SKU determines the area of the world in which the printer can be used.

Battery Disposal



The EPA certified RBRC® Battery Recycling Seal on the Lithium-Ion (Li-Ion) battery supplied with your printer indicates Zebra Technologies Corporation is voluntarily participating in an industry program to collect and recycle these batteries at the end of their useful life, when taken out of service in the United States or Canada. The RBRC program provides a convenient alternative to placing used Li-Ion batteries into the trash or the municipal waste stream, which may be illegal in your area.



Important • When the battery is depleted, insulate the terminals with tape before disposal.

Call 1-800-8-BATTERY for information on Li-Ion battery recycling and disposal bans/restrictions in your area.

Zebra Technologies Corporation's involvement in this program is part of our commitment to preserving our environment and conserving our natural resources.

Outside North America, please follow local battery recycling guidelines.

Product Disposal

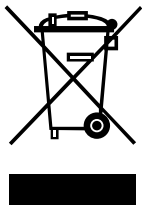

The majority of this printer's components are recyclable. Do not dispose of any printer components in unsorted municipal waste. Please dispose of the battery according to your local regulations, and recycle the other printer components according to your local standards.

For more information, please see our web site at: <http://www.zebra.com/environment>.

Alert Messages

The printers will display the following alert messages on the Information Screen to inform the user of various performance conditions that might occur with the ZQ210.

Event	Type	English Phrase
Download Firmware	User Activity	Download FW
Download Failed	User Activity	Download Failed
BT Pairing PIN	Timed – 30 seconds. Configuration button accepts pairing pin. If timeout expires, go to BT Pairing Failed Alert.	Pairing: 123456
BT Pairing Ongoing	User Activity	Pairing Ongoing
BT Pairing Accepted	Timed – 5 seconds	Pairing Accepted
BT Pairing Rejected	Timed – 5 seconds	Pairing Rejected
BT Pairing Failed	Timed – 5 seconds	Pairing Failed
BT Pairing Success	Timed – 5 seconds	Pairing Success
Head Over temp	User Activity	Head Overtemp
Head Under temp	User Activity	Head Undertemp
Battery Too Low	User Activity	Battery Too Low
Media Out	User Activity	Media Out
Head Open	User Activity	Head Open
Charge Error	User Activity	Charge Error
Battery Missing	User Activity	No Printing
Battery Low	User Activity	Battery Low
Printer Ready	Timed – 30 seconds	Printer Ready

Using Zebra.com

The following example illustrates the search function on Zebra’s website for finding specific documents and downloads.

Example 1: Finding the User Guide.

Step 1: Go to <http://www.zebra.com/us/en/support-downloads.html>

Type the appropriate printer name in search box.

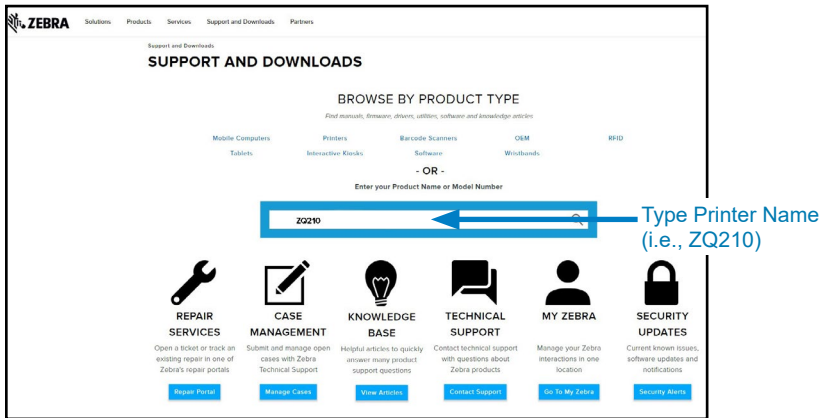

Step 2: Click on “Manuals” tab on the printer main page.

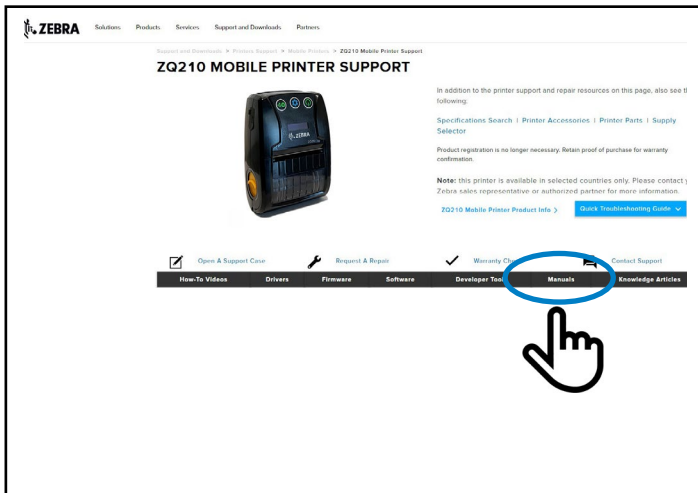

Step 3: Click on the dropdown menu to choose your language, and then click on the download button next to the selected manual.

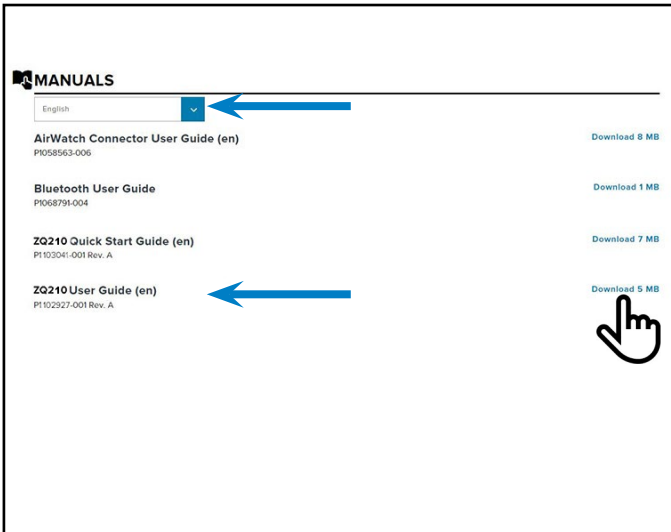

Product Support

To contact product support in your region, go to:

<https://www.zebra.com/contact>.

When calling with a specific problem regarding your printer, please have the following information on hand:

- Model number/type (e.g., ZQ210).
- Unit serial number.
- Product Configuration Code (PCC) (refer to “Appendix D” on page 59)

Index

Symbols

5-Bay Docking Cradle 21

A

Accessories 41–64, 56
Appendix A, USB Cables 57
Appendix B, Media Supplies 58
Appendix C, Maintenance Supplies 58
Appendix D, Parameters Menus 59
Appendix F, Battery Disposal 60
Appendix G, Alert Messages 61
Appendix H, Using Zebra.com 62
Appendix I, Product Support 64

B

Battery, installing 15
Battery pack 10
Battery Safety 18
Belt Clip 41
Black Mark Dimensions 37
Bluetooth 31
Bluetooth, minimum security modes 33
Bluetooth, networking 31
Bluetooth, security modes 32

C

Cable Communication 30
Charger Safety 18
Communications Diagnostics 48
Configuration Label, sample 50
CPCL Font and Bar Code
 Specifications and Commands 54

D

Designing Labels 35
Dimensions, ZQ210 55
Document Conventions 7

G

General Cleaning Instructions 43
Getting Ready to Print 15

H

Home Menu Screen 27

I

Installing the Battery 15
Introduction to the ZQ210 Printer 8

L

Label Areas 37
Label Design Examples 38
LCD Control Panel 25, 46

M

Made for iPhone (MFi) 12
Media, loading 22

N

Near Field Communication (NFC) 12, 39

P

Power-Up Sequences 28
Preventive Maintenance 43
Printer Status Icons 26
Printing Method
 Direct Thermal 11
Programming language
 CPCL 8

Q

QR Code 11

S

Soft Case 42
Specifications, label 53
Specifications, memory and communications 52
Specifications, physical, environmental and electrical 55
Specifications, printing 52

Status Bar Icons 26

T

Troubleshooting, tests 48

Troubleshooting, topics 46

V

Verify printer is working 28

W

Wearing the Printer 41

Z

Zebra Setup Utilities 31

ZQ210 Accessories 56

