



# ExCam XPT Q6075

## User Manual



**SAMCON**

Prozessleittechnik GmbH

## Table of contents

<b>1</b>	<b>Introduction .....</b>	<b>4</b>
<b>2</b>	<b>Technical data .....</b>	<b>4</b>
2.1	Explosion protection .....	4
2.2	Electrical parameters of the camera .....	5
2.3	Connection cable Ex-d - Ex-e (ASKDP03-T) .....	5
2.4	Video-technical characteristics .....	6
2.5	Other technical data .....	6
<b>3</b>	<b>Safety Instructions .....</b>	<b>7</b>
<b>4</b>	<b>Assembly .....</b>	<b>8</b>
<b>5</b>	<b>Electrical connection .....</b>	<b>10</b>
5.1	Equipotential bonding/Grounding .....	11
5.2	Connection work on the device (terminal box) .....	12
5.3	External connection and protection .....	15
5.3.1	Direct routing from the ExTB-3 into the safe area .....	15
5.3.2	Routing via ExConnection Rail (optional accessories) .....	16
5.3.3	Appropriate cables & cable entries .....	17
5.3.4	Cable kits - "plug and play" connection packages .....	19
5.3.5	Fusing .....	21
5.3.6	Plug assignment (RJ45) .....	21
5.3.7	Tests prior to switching on voltage .....	22
<b>6</b>	<b>Opening the pressure-resistant housing .....</b>	<b>23</b>
<b>7</b>	<b>Network access and visualization .....</b>	<b>24</b>
7.1	Browser Support.....	24
7.2	Assigning the IP address.....	24
7.3	Password/ Identification .....	25
<b>8</b>	<b>Maintenance/ Modification.....</b>	<b>26</b>
<b>9</b>	<b>Reparation.....</b>	<b>26</b>
<b>10</b>	<b>Disposal/ Recycling .....</b>	<b>26</b>
<b>11</b>	<b>Drawings &amp; 3D models .....</b>	<b>27</b>

## Table of Figures and Charts

Fig. 2-1 Sectional view of ASKDP03-T .....	6
Fig. 5-1 ExCam XPT Q6075 equipotential bonding .....	11
Fig. 5-2 Camera (Ex-d) and terminal box (Ex-e).....	12
Fig. 5-3 Video Tutorial ExTB-3 .....	13
Tab. 5-4. Wire assignment of terminal box ExTB-3 .....	13
Fig. 5-5 Sample circuit of terminal box ExTB-3.....	14
Fig. 5-6 Photo of the occupied terminal box ExTB-3 .....	14
Fig 5-7 ExTB-3 -> Safe area.....	15
Fig. 5-8 ExTB-3 -> ExConnection Rail.....	16
Fig. 5-9 Barrier gland.....	18
Fig. 5-10 Cable kit – plug & play connection package .....	19
Tab. 5-11 Available cable kits.....	20
Tab. 5-12 Recommendation for fusing .....	21
Fig. 5-13 Plug assignment RJ45.....	22
Fig. 6-1 Axis IP Utility .....	25

## History of revisions

Product: ExCam® XPT Q6075  
 Title: User Manual for ExCam® XPT Q6075  
 Doc. -Id. 200514-PT08BA-SS-ExCam XPT-Q6075\_en\_rev.00.docx  
 Author: Steffen Seibert, Grad. Eng.  
 Created on: 14.05.2020

Rev. Index	Date	Name	Comment	Approved by the ATEX Supervisor
0	14.05.2020	S.Seibert	Compilation of the document	

# 1 Introduction

In the ExCam XPT Q6075 is a powerful IP dome camera of the latest generation, with 2-megapixel resolution at 1920x1080p points. It is certified by ATEX, IECEx & EAC-Ex (and more).

This dome camera can endlessly rotate around its own axis. When tilted, it covers a 180° area, and the picture is automatically turned around. This is done with a high speed and precision. Thanks to the Lightfinder-Technology you receive sharp images and superior details even in demanding light conditions. Not only the excellent light sensitivity makes this camera that special but also the 40-fold optical zoom produces sharp, precise images and brilliant wide-angle images.

The ExCam series is certified both in accordance with the European (ATEX) and international directive (IECEx). The explosion-protected housing is approved for the ATEX group II for zones 1, 2, 21 and 22 including the explosion groups IIC / IIIC. To see other approvals, please visit our website at [www.samcon.eu](http://www.samcon.eu)

In designing the ExCam XPT Q6075, we attached a very high importance to safety, mechanical precision and high quality of stainless steel.

## 2 Technical data

### 2.1 Explosion protection

Identification marks

acc. to Directive 2014/34/EU:

 II 2G (zone 1 and 2)

 II 2D (zone 21 and 22)

Explosion protection (gas):

Ex db IIC T6 Gb

Explosion protection (dust):

Ex tb IIIC T80°C Db

Protection class:

IP 68 (IEC /EN 60529)

Transport/storage temperature:

0°C...+40°C

Ambient temperature (EX)<sup>1</sup>:

-50°C...+60°C

<sup>1</sup> Explosion protection-relevant maximum ambient temperature range relevant to explosion protection, deviation from the functional temperature range, functional temperature range (MTBF)

Named testing laboratory:	TÜV Rheinland (number 0035)
EU type approval certificate:	TÜV 18 ATEX 8218X
IECEX Certificate of Conformity:	IECEX TUR 18.0023X
EAC-Ex TUR Report:	RU C-DE.AB.61.B.00381/19
IA No:	MASC MS/18-3256X
Further certification:	see <a href="https://www.samcon.eu/en/products/network/excam-xpt-q6075">https://www.samcon.eu/en/products/network/excam-xpt-q6075</a>

## 2.2 Electrical parameters of the camera

### 24VDC Power input:

Permissible temperature range:	$-50^{\circ}\text{C} < T_{\text{amb}} < +60^{\circ}\text{C}$
Power supply:	24 VDC
Power consumption:	approx. 60W @ -50°C (depends on the temperature)

### PoE+ Power input:

Permissible temperature range:	$-0^{\circ}\text{C} < T_{\text{amb}} < +60^{\circ}\text{C}$
Power supply:	PoE, IEEE 802.3at class 4
Reference voltage:	48 VDC (44...54 VDC)
Maximum power consumption:	17.1 W
Typical power consumption:	11 W

## 2.3 Connection cable Ex-d - Ex-e (ASKDP03-T)

Description:	Data transfer and power supply of the camera module (compliant with DIN EN 60079-14),
Jacket colour:	green (GN), similar to RAL3001
Outside diameter:	$15.50 \pm 0.6 \text{ mm}$
Bending radius:	15 x Da when installed and 10 x Da after relocation
Data line:	4 x 2 x AWG23/1 CAT.6a
Performance elements:	3G1.5 (BK-BU-GN/YE)
Properties:	PUR halogen-free, flame-retardant, UV-resistant, chemical resistance, shielded (see <a href="http://www.samcon.eu">www.samcon.eu</a> )

Quick link:

[https://www.samcon.eu/fileadmin/documents/en/60-Assembling&mounting/ASKDP03-T\\_Datasheet.pdf](https://www.samcon.eu/fileadmin/documents/en/60-Assembling&mounting/ASKDP03-T_Datasheet.pdf)



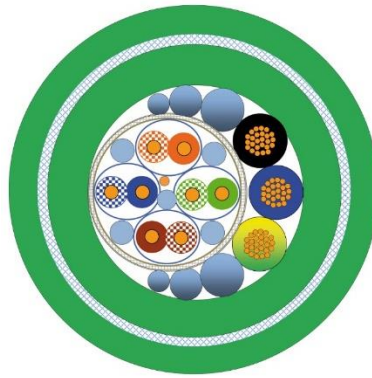

Fig. 2-1 Sectional view of ASKDP03-T

## 2.4 Video-technical characteristics

We use the AXIS Q6075 Dome Camera in a pressure-resistant enclosure. For details, please refer to the Product Documentation, video-technical data of AXIS®:

<https://www.axis.com/products/axis-q6075>



## 2.5 Other technical data

	<b>Camera (Ex-d)</b>	<b>Terminal box (Ex-e)</b>
Permissible ambient temperature	0°C ... +60°C (for PoE+ power supply) -50°C ... +60°C (at 24 VDC power supply)	-60°C ... +55°C
Protection class as per EN 60529/IEC 529	IP68 (Test conditions: 24h/3m water column 5°C°)	IP66
Housing material	- stainless steel, mat. no. 1.4404 - LEXAN	polyester resin
Weight	20 kg	about 1 kg
Dimensions	D195mm x 378mm	145mm x 145mm x 71mm

### 3 Safety Instructions

Please absolutely adhere to the directions for safety in the installation instructions for the T08 ExCam series!



Quick link:

<https://www.samcon.eu/fileadmin/documents/en/20-Ex-Cameras-Analog/ExCam-Series-T08-EX-Installation-Manual-2018.pdf>

It is absolutely mandatory to observe the national safety regulations and regulations for prevention of accidents, as well as the safety instructions given below in this User Manual!



**Attention!**

Cameras of the type T08 ExCam are not suitable for use in zone 0 and zone 20. The ambient temperature, temperature class and explosion group as stated on type plate must be observed! Alterations are not permitted! The camera is to be operated in sound conditions and in the intended way.



**Attention!**

Only original parts of SAMCON Prozessleittechnik GmbH may be used for repairs. Repairs concerning the explosion protection may only be carried out in accordance with the nationally applied regulations and by SAMCON Prozessleittechnik GmbH.



**Attention!**

Prior to installation, take external sources of heat or cold into account! The temperature ranges prescribed for storage, transport and operation must be adhered to!



**Attention!**

Observe the warnings given on the type plate:

**“WARNING – DO NOT OPEN IN HAZARD AREAS“**

**“WARNING – DO NOT OPEN WHILE ENERGIZED“**



The use in hazardous areas with regard to temperature and dust layers is defined in the respective national regulations.



When installing the ExCam, adhere to the requirements of the EN/IEC 60079-14.

## 4 Assembly

### Work preparation:



**Attention!**

Prepare your work carefully and in accordance with the relevant regulations.



**Attention!**

Depending on classification of hazard areas, a work approval has to be obtained. When you open the pressure-resistant enclosure under voltage, it is absolutely necessary to prevent potentially explosive atmosphere!

To ensure the best image quality delivered by the network camera, plan the installation site carefully (consider light conditions, object distance or size, angle and minimum object distance to the focus).

- Use appropriate tools and aids
- When working, ensure a safe stand.
- Make sure that any static charge is avoided



**Attention!**

Please pay attention to the national security, installation and accident prevention regulations (e.g. DIN EN 60079-14) and the safety instructions given below in this User Manual, as well as the ones in the Installation Guidelines!



**Attention!**

Adhere to the provisions of the IECEx ATEX and EX installation instructions for mounting and starting up!

ExCam® XPT Q6075 consists of a flame-proof camera housing (Ex-d) and a connection chamber of a high degree of safety (Ex-e). Both areas are separated by a reinforced 5 mm line.

Mount the camera as high as possible, according to the desired field of view.

Install the connection chamber so that a good accessibility is provided, in order to facilitate electrical connection.



**Attention!**

Please pay attention to the national and local regulations for mounting heavy loads. In case of doubt, take appropriate security measures.





Drawings for drill hole patterns and further information can be viewed on our product page:

Quick link:

<https://www.samcon.eu/en/products/network/excam-xpt-q6075/>



### Option mounting accessories

<p>Wall bracket WMB-...</p>		<p><b>WALL MOUNT EXCAM XPT (01538-001)</b>        Wall bracket for the T08-TNXCD series        Suitable for hanging the camera on walls.        The scope of delivery includes a protective cover for the wall bracket. The cover protects the cable and cable routing as required by 60079-14 and does not let the cable and cable glands be directly exposed to water splashes.        Material: stainless steel 1.4404        Load bearing: 45 kg        Dimensions: 460 x 140 x 220 mm</p>
<p>Pole adapter PMB-...</p>		<p><b>POLE MOUNT EXCAM XPT (01539-001)</b>        TNXCD pole adapter for wall mount        Material: stainless steel 1.4404        Suitable for pole diameters between 110 and 150 mm        Load-bearing capacity: 50 kg</p>
<p>Ceiling adapter CMB-...</p>		<p><b>CEILING MOUNT EXCAM XPT</b>        TNXCD pole adapter for ceiling mount        Material: stainless steel 1.4404        Load-bearing capacity: 50 kg</p>

## 5 Electrical connection



**Attention!**

**The electrical connection of the equipment must only be carried out by officially qualified and skilled personnel!**



**Attention!**

**It is absolutely necessary to ground the ExCam® series housing via the PA connection.**



**Attention!**

**The minimum length of the connecting cable must not be less than three meters! The connection cable must be protected!**



**Attention!**

**Please pay attention to the national security, installation and accident prevention regulations (e.g. DIN EN 60079-14) and the safety instructions given below in this User Manual, as well as the ones in the Installation Guidelines!**

The ExCam® XPT Q6075 is equipped with an electrical connection cable of type ASKDP03-T and a pre-assembled and pre-wired terminal box ExTB-3. The maximum transmission range from the camera to the next active network interface is 100 meters and can be individually specified by the client. The user is NOT authorised to do any electrical connection procedures inside the pressure-resistant enclosure.

## 5.1 Equipotential bonding/Grounding

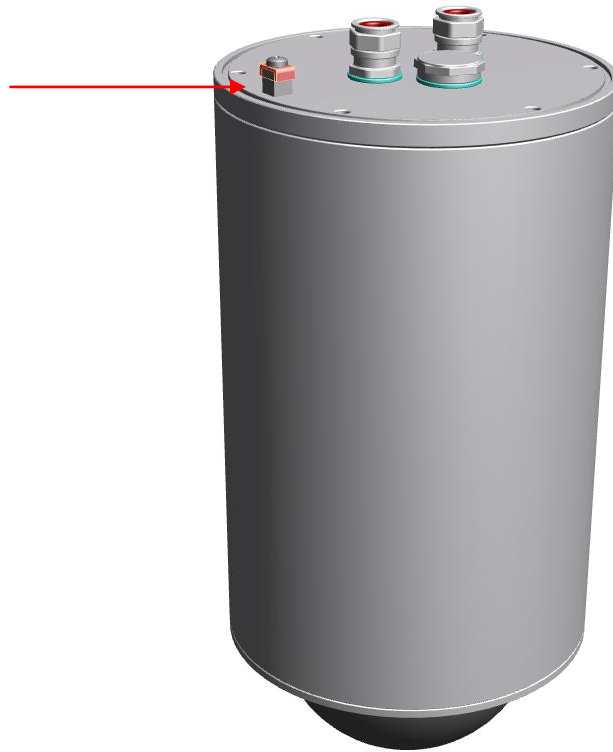

Fig. 5-1 ExCam XPT Q6075 equipotential bonding

Equipotential bonding/grounding of the camera body is absolutely necessary, in order to avoid static charges and formation of sparks. For this purpose, a screw terminal is provided at the rear side, at the bottom (right) (see Figure 5.1). The cross-section of the equipotential bonding should comply with the National Ground Rules (at least 4 mm<sup>2</sup>).

Wiring table:

Potential	Colour (IEC 60757)	Cross-section	Comment
PA	GN/YE	4 mm <sup>2</sup> (rigid)	-

## 5.2 Connection work on the device (terminal box)



Fig. 5-2 Camera (Ex-d) and terminal box (Ex-e)



**Attention!**

**Connect the device the electric mains exclusively via the box ExTB-3 terminal!**



**Attention!**

**Never open the Ex-e terminal box under voltage!**



**Attention!**

**Adhere to the international installation regulations for connection chambers with increased safety (Ex-e).**



**Attention!**

**Adhere to attached separate Usual Manual for the Ex-e connection chamber.**

## Video Tutorial:

Observe our video tutorial:

“SAMCON 01 Installation and Wiring Connection to ExtB-3”  
<https://go.samcon.eu/v01>

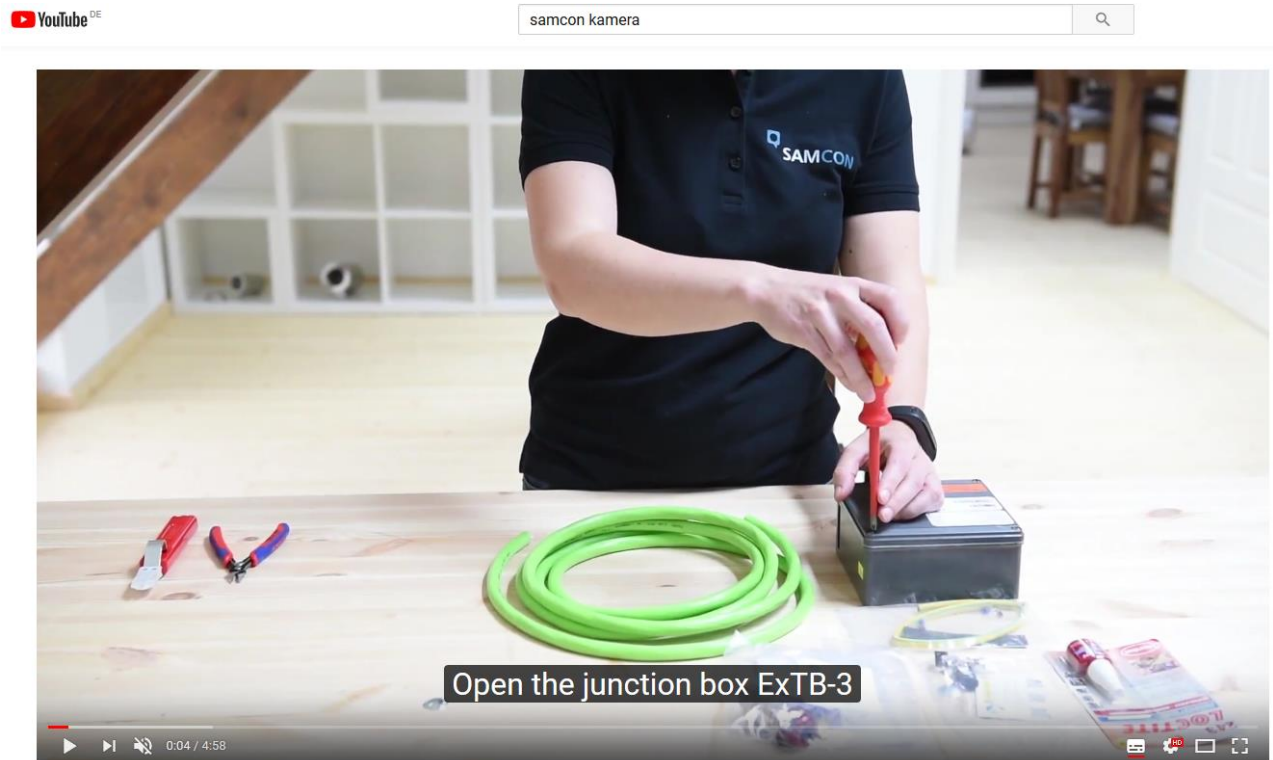

Fig. 5-3 Video Tutorial ExtB-3

The pin assignment of the ASKDP03-T is executed in accordance with the standard EIA/TIA-568B for 100BaseTX and 24VDC, as follows:

Camera (Ex-d) (T568B)	Colour ASKDP03-T (IEC60757)	Terminal ExtB-3	Cross-sectional surface	Comment
Reinforcement	YE / GN	PE	2.5 mm <sup>2</sup>	Flex
Tx+	WH / OG	1	0.26 mm <sup>2</sup>	Solid conductor
Tx-	OG	2	0.26 mm <sup>2</sup>	Solid conductor
Rx+	WH / GN	3	0.26 mm <sup>2</sup>	Solid conductor
(PoE +48 VDC)	BU	4	0.26 mm <sup>2</sup>	Solid conductor
(PoE +48 VDC)	WH / BU	5	0.26 mm <sup>2</sup>	Solid conductor
Rx-	GN	6	0.26 mm <sup>2</sup>	Solid conductor
(PoE GND)	WH / BN	7	0.26 mm <sup>2</sup>	Solid conductor
(PoE GND)	BN	8	0.26 mm <sup>2</sup>	Solid conductor
GND/SHD	YE / GN	PE	2.5 mm <sup>2</sup>	Flex
L+	BK	9	1.5 mm <sup>2</sup>	L+ 24VDC
L-	BU	10	1.5 mm <sup>2</sup>	L- 24VDC
PE	YE / GN	PE	1.5 mm <sup>2</sup>	PE

Tab. 5-4. Wire assignment of terminal box ExtB-3

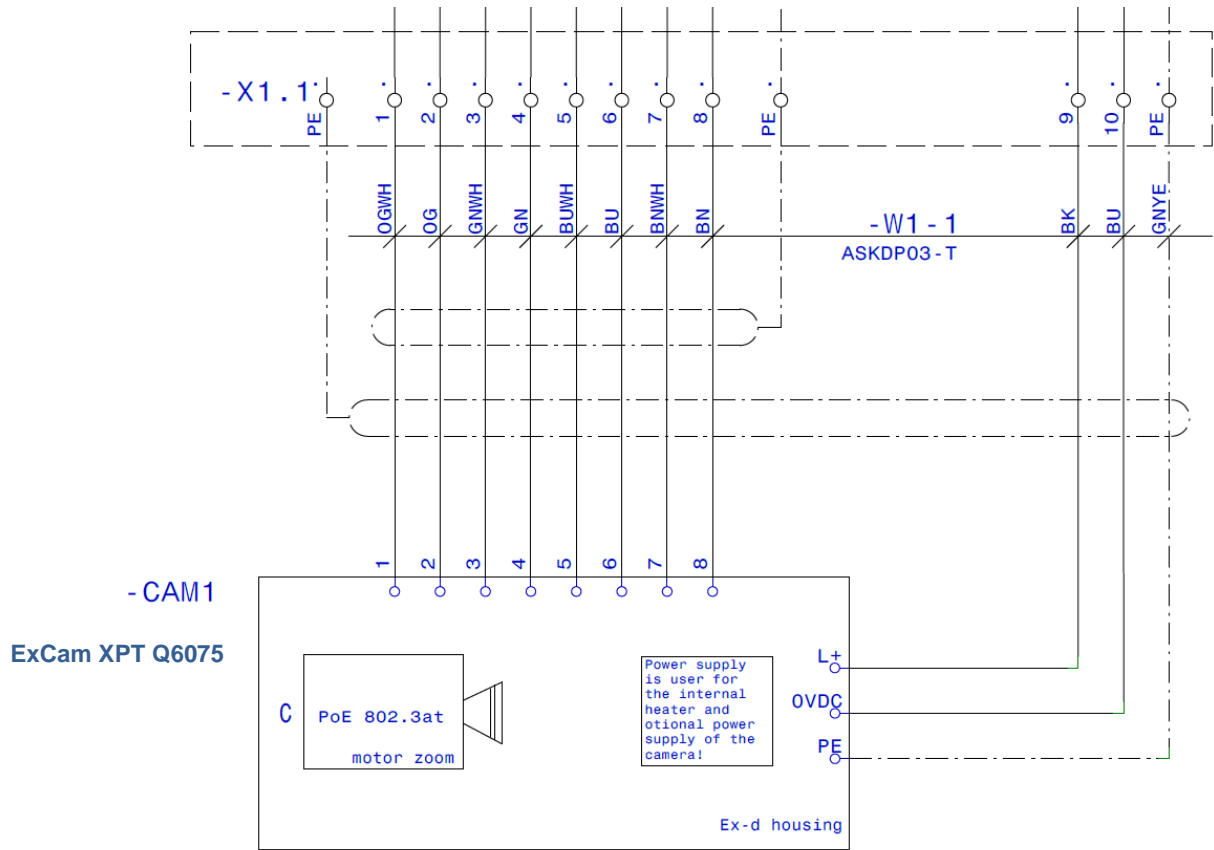

Fig. 5-5 Sample circuit of terminal box ExTB-3

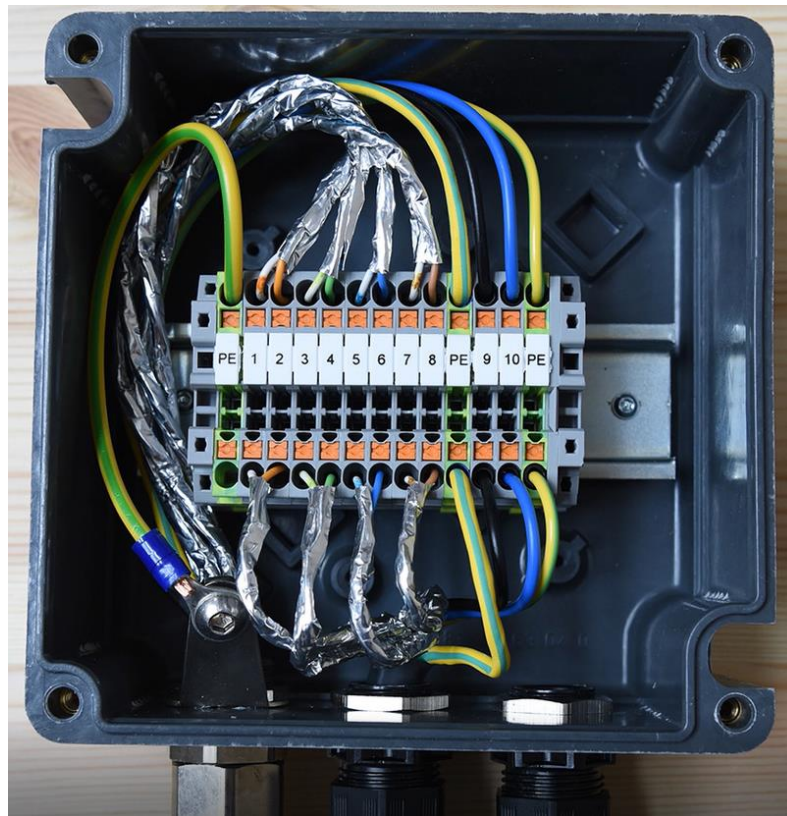

Fig. 5-6 Photo of the occupied terminal box ExTB-3



**Attention!**

Perform the foiling up to about 10mm to the terminals, in order to prevent alien crosstalk. Make sure that the foiling cannot cause any short circuit of the data couples!



**Attention!**

Bring the twisted pair composite approximately 10mm close to the terminals, in order to ensure the immunity to disturbance.



**Attention!**

Use only terminals approved by SAMCON.



**Attention!**

Finally, check your network installation by per Class-D Link Test.

### 5.3 External connection and protection

There are several options of assigning the ExTB-3 terminal box in a safe area:

#### 5.3.1 Direct routing from the ExTB-3 into the safe area

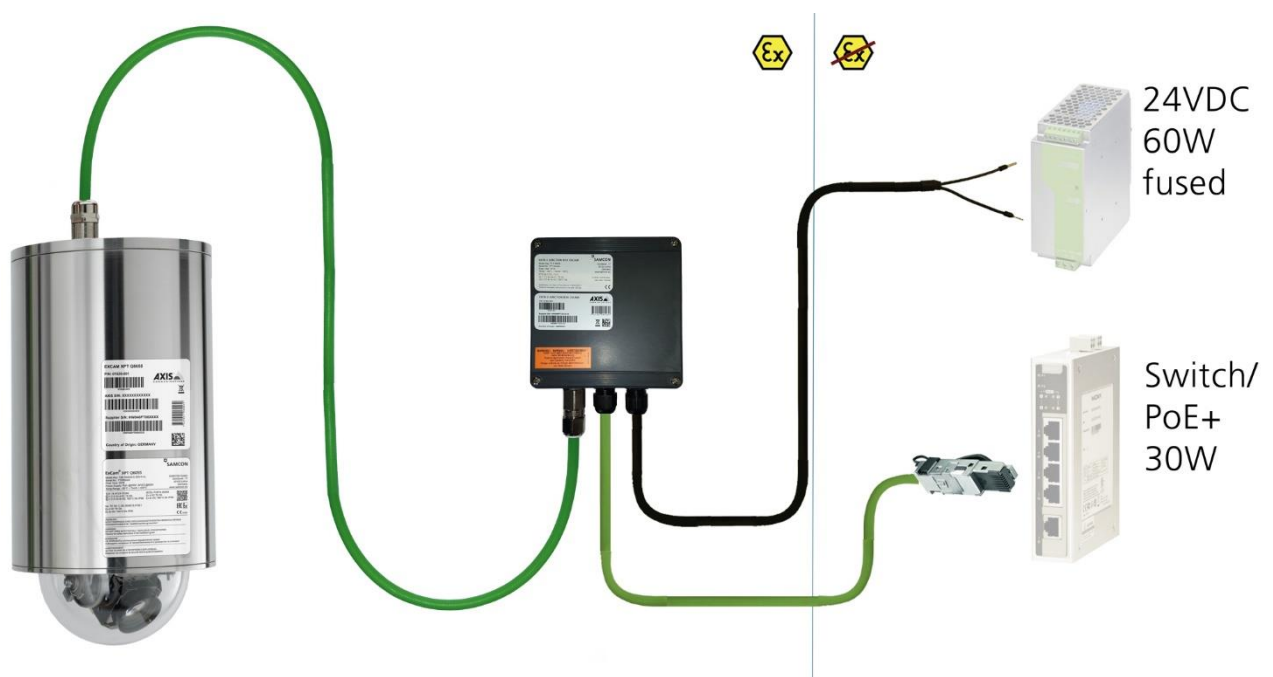

Fig 5-7 ExTB-3 -> Safe area

In the case of direct routing from ExTB-3 into the safe area, the power supply and the voltage signal is led from the safe area to the terminal box. Please observe the terminal box assignment, as described above.





**Attention!**  
Cables and wires must comply with the requirements of the IEC 60079-0/1/7 & 14.



**Attention!**  
The supply line must have a sufficient cross-section. The cable protection must comply with national and international regulations.

### 5.3.2 Routing via ExConnection Rail (optional accessories)

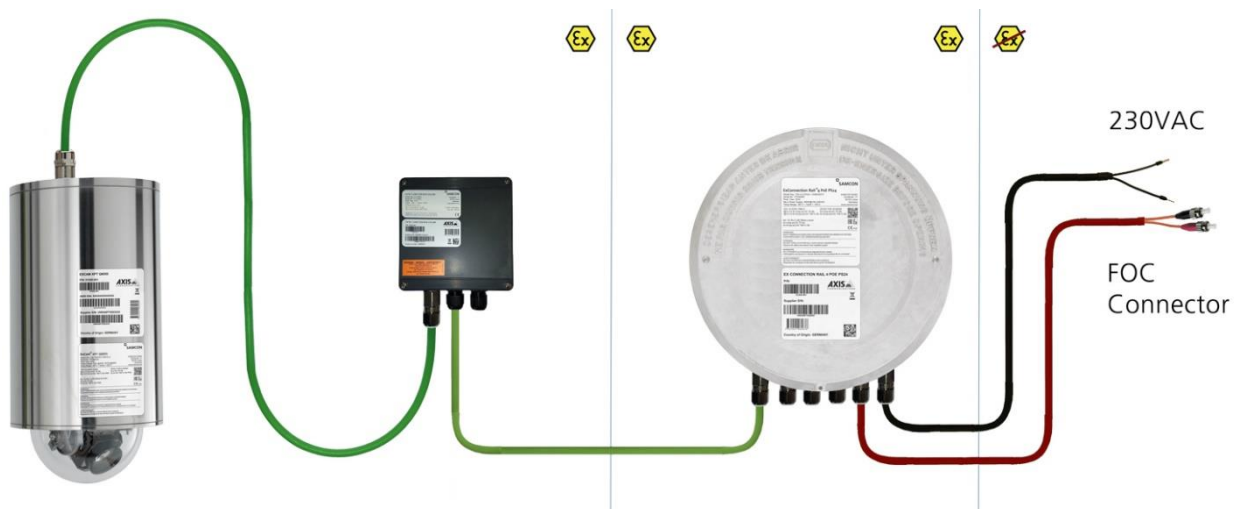

Fig. 5-8 ExTB-3 -> ExConnection Rail

In the case of routing the ExTB-3 into a larger ExConnection Rail, larger installation distances can be managed.

*Note:*

*In explosive areas ExConnection Rail (optional accessories) acts as PoE+ switch, media converters from copper to fibre-optic cable, as well as a power supply to the cameras.*



**Attention!**  
Cables and wires must comply with the requirements of the IEC 60079-0/1/7 & 14.



**Attention!**  
The supply line must have a sufficient cross-section. The cable protection must comply with national and international regulations.



### 5.3.3 Appropriate cables & cable entries

To ensure the device safety, you should correctly select the right cables, wires and cable glands.



**Attention!**

**Cables and wires must comply with the requirements of the IEC 60079-0/1/7 & 14.**



**Attention!**

**The supply line must have a sufficient cross-section. The cable protection must comply with national and international regulations.**

To see non-binding configuration and planning guidelines, please visit:

<https://www.samcon.eu/fileadmin/documents/en/99-Knowledgecenter/Cable-Gland-selection-for-Ex-d-enclosures.pdf>



In particular for installations which require a suitable barrier gland, make sure that you handle them correctly and adhere to the rules and notes given in the respective mounting instructions.

We show the essential procedures in the following video tutorial:

**Video Tutorial:**

Observe our video tutorial:

“SAMCON 02 Installation Ex d gland”  
<https://go.samcon.eu/v02>

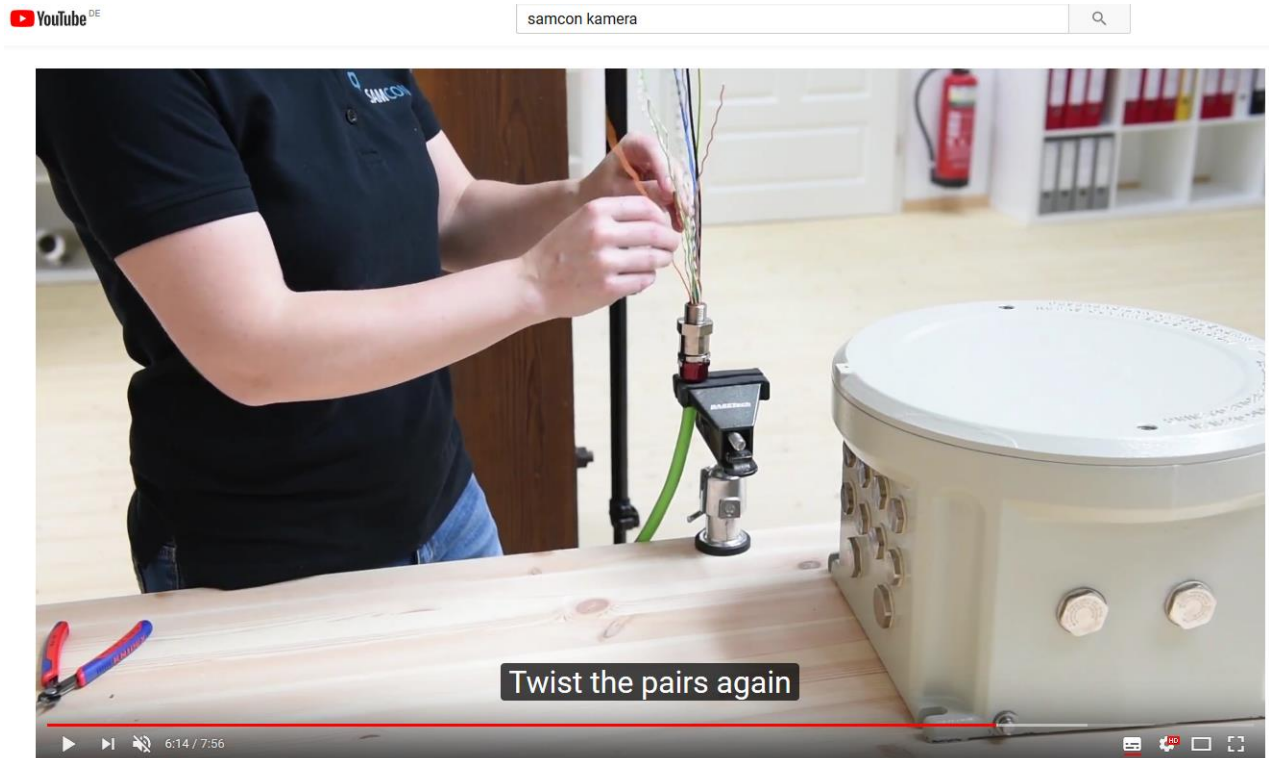

Fig. 5-9 Barrier gland

### 5.3.4 Cable kits - "plug and play" connection packages

As an option, there are various cable kits for different cables are available in different lengths. The connection packages include everything you need for a professional system installation:



- ✓ 10/25/95 m SKDP03-T system cable, digital (a)
- ✓ 1 x barrier gland with sealing compound (b)
- ✓ 5 ml of Loctite thread locking (c)
- ✓ 1 x CAT6 RJ45 industrial connectors (5.5 - 10.5 mm) (d)
- ✓ Heat-shrinkable tube 40 cm, yellow-green (e)
- ✓ Heat-shrinkable tube 10 cm, black (e)
- ✓ 8 x cable end sleeves (e)
- ✓ 1 x documentation

Fig. 5-10 Cable kit – plug & play connection package

Connection packages available:

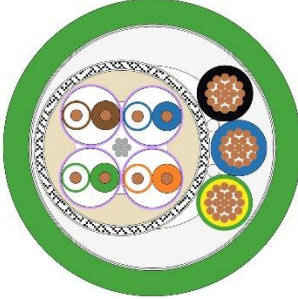
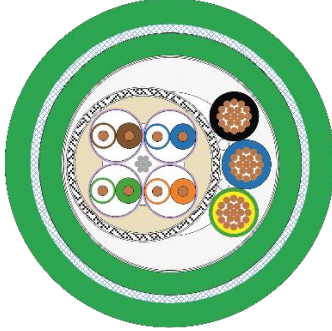
Length	Non-armoured cable SKDP03-T	Armoured cable ASKDP03-T
		
10 meters	<p><b>SKDP03-T CABLE EXCAM 10M (01540-001)</b></p> <p>This cable set includes:            10 meters SKDP03-T system cable, digital            1 x barrier gland Ex-d            5 ml Loctite 243 screw locking            1 x CAT6 RJ45 industrial plug            1 x documentation</p>	<p><b>ASKDP03-T CABLE EXCAM 10M (01543-001)</b></p> <p>This cable set includes:            10 meters ASKDP03-T system cable, digital            1 x bolted connection Ex-d            1 x bolted connection Ex-e            5 ml Loctite 243 screw locking            1 x CAT6 RJ45 industrial plug            1 x documentation</p>
25 meters	<p><b>SKDP03-T CABLE EXCAM 25M (01541-001)</b></p> <p>This cable set includes:            25 meters SKDP03-T system cable, digital            1 x barrier gland Ex-d            5 ml Loctite 243 screw locking            1 x CAT6 RJ45 industrial plug            1 x documentation</p>	<p><b>ASKDP03-T CABLE EXCAM 25M (01545-001)</b></p> <p>This cable set includes:            25 meters ASKDP03-T system cable, digital            1 x bolted connection Ex-d            1 x bolted connection Ex-e            5 ml Loctite 243 screw locking            1 x CAT6 RJ45 industrial plug            1 x documentation</p>
95 meters	<p><b>SKDP03-T CABLE EXCAM 95M (01542-001)</b></p> <p>This cable set includes:            95 meters SKDP03-T system cable, digital            1 x barrier gland Ex-d            5 ml Loctite 243 screw locking            1 x CAT6 RJ45 industrial plug            1 x documentation</p>	<p><b>ASKDP03-T CABLE EXCAM 95M (01542-001)</b></p> <p>This cable set includes:            95 meters ASKDP03-T system cable, digital            1 x bolted connection Ex-d            1 x bolted connection Ex-e            5 ml Loctite 243 screw locking            1 x CAT6 RJ45 industrial plug            1 x documentation</p>

Tab. 5-11 Available cable kits

### 5.3.5 Fusing

PoE+ power supply requires no fuses.

The power supply fusing depends on the cable cross-section and length.



**Attention!**

Recommendation for fusing relates to 60W@24VDC at 100meters 1.5 mm<sup>2</sup>



**Attention!**

When the heating switches on, there are high current peaks! Use slow-blow fuses.



**Attention!**

Please pay attention to the national and international regulations regarding selectivity and line protection.

Potential/ Wire no.	Colour (IEC60757)	Conductor	Voltage	Maximum power consumption/fusing:
L+ / 1	BK	1.5mm <sup>2</sup> , stranded wire	+24 VDC	60 W of continuous power Fine-wire fuse (L+) 6000 mA -T- slow-blow (high inrush load!)
L- / 2	BU	1.5Mm2, <sup>2</sup> , stranded wire	0 VDC / GND	
PE	YE/GN	1.5Mm2, <sup>2</sup> , stranded wire	PE	

Tab. 5-12 Recommendation for fusing

### 5.3.6 Plug assignment (RJ45)

The data transfer of the ExCam XPT Q6075 series uses a 100 Mbit/s Ethernet connection (100BASE-TX).

If the cable termination uses a plug, (figure 5.3) it has to be plugged into the associated slot of the network device. Prior to connecting it to the camera, the network device (PSE) can already be supplied with power, hence there is no „power ON“ priority which has to be observed.



**Attention!**

Use the appropriate RJ45 plug! Check shielding, cross-section and the outside diameter of the cable!



**Attention!**

It is imperative to ensure a correct assignment of the individual wires according to the EIA/TIA-568B"



**Attention!**  
Finally, check your network installation by per Class-D Link Test.

Observe our video tutorial:

“SAMCON 03 Mounting and installing the RJ45 jack to SAMCON cables”  
<https://go.samcon.eu/v03>

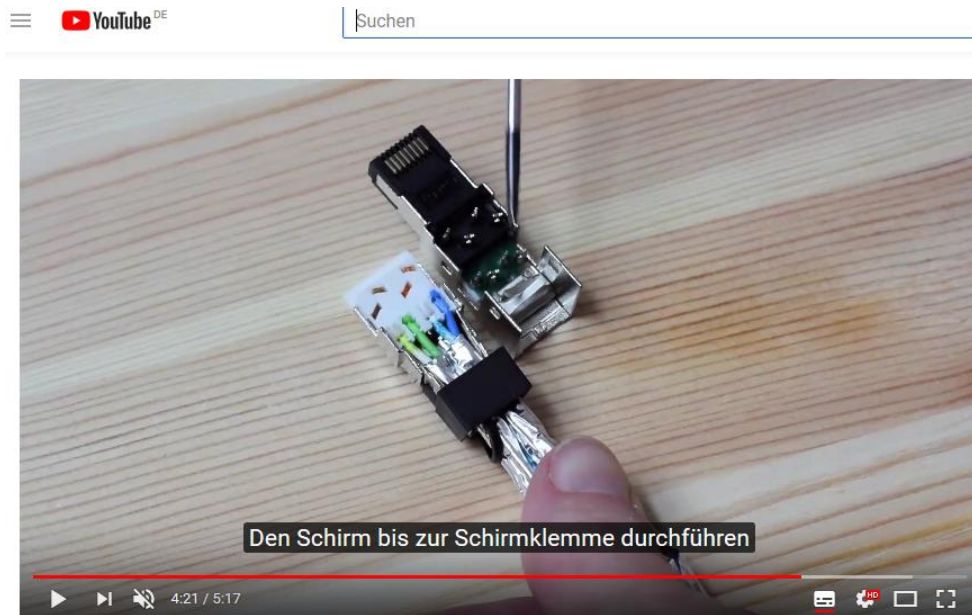

Fig. 5-13 Plug assignment RJ45

### 5.3.7 Tests prior to switching on voltage



**Attention!**  
Prior to commissioning, all tests as indicated by the national regulations have to be executed. Furthermore, the correct function and installation of the device has to be checked in accordance with this user manual and other applicable regulations.



**Attention!**  
Incorrect installation and operation of the camera may lead to a loss of warranty!



**Attention!**  
Do not switch on the camera at temperatures below 0°C!

## 6 Opening the pressure-resistant housing

To open the TNXCD housing, you need a special tool. The customer should not open it. If you think that the housing has to be opened for unforeseeable reasons, please contact our support team at first ([Support@samcon.eu](mailto:Support@samcon.eu)).

Always adhere to the explosion-relevant rules:



**„WARNING – MAY NOT BE OPENED IN HAZARD AREAS.“**

**Note: Depending on classification of hazard areas, a work approval has to be obtained.**

**Even after switching on the power supply, it is absolutely imperative to avoid potentially explosive atmosphere when opening the camera housing. Opening the housing requires disassembly and working in a safe (i.e. non-explosive!) area.**



**Attention!**

**Heed that you do not damage the thread surface of the flame-proof gap.**



**Attention!**

**Heed that you do not damage the housing seals. Keep them clean!**



## 7 Network access and visualization

The most important procedures of the first starting up the camera are described below. The configuration menu of the web surface allows an intuitive navigation and offers several configuration possibilities. For detailed documentation and information how to use the web Interface, please see the User Manual for Axis or visit the following website:

<https://www.axis.com/products/axis-q6075>



At delivery, the ExCam XPT Q6075 is set to the applicable net frequency (50Hz or 60Hz). If the camera is used at a location with a differing net frequency, a flickering of the picture might be noticeable, particularly in surroundings with fluorescent tubes. In such a case, the applicable settings have to be carried out within the menu “System Options > Advanced > Plain Config”.

User: root  
Password: root

### 7.1 Browser Support

A list of the currently supported web browsers, operating systems, required add-ons, etc. can be viewed at:

[http://www.axis.com/techsup/cam\\_servers/tech\\_notes/browsers.htm](http://www.axis.com/techsup/cam_servers/tech_notes/browsers.htm)



### 7.2 Assigning the IP address

The ExCam XPT Q6075 is intended for use in an Ethernet network and requires an IP address to access and control it. In the most today's networks, a DHCP server is integrated. This server automatically assigns an IP address.

If there is no DHCP server available in the network, the ExCam IP's default address is **“192.168.0.90” (subnet masking 255.255.255.0)**.



With the AXIS IP Utility, it is possible to determine the IP address under Windows; the included USB stick contains this application.



**In case it is not possible to assign the IP address, it might be necessary to change the firewall settings!**

The “AXIS IP Utility“ tool automatically recognizes all ExCam devices and visualises them in the device list. It can also be used to manually assign a static IP address. For this purpose, the ExCam XPT Q6075 network camera has to be installed in the same physical network segment (physical subnet) as the computer on which the AXIS IP Utility is running. The network signature of ExCam XPT Q6075 is "AXIS Q6075" (see Figure 6.1). MAC address and serial number for clear device identification are also detected and displayed.

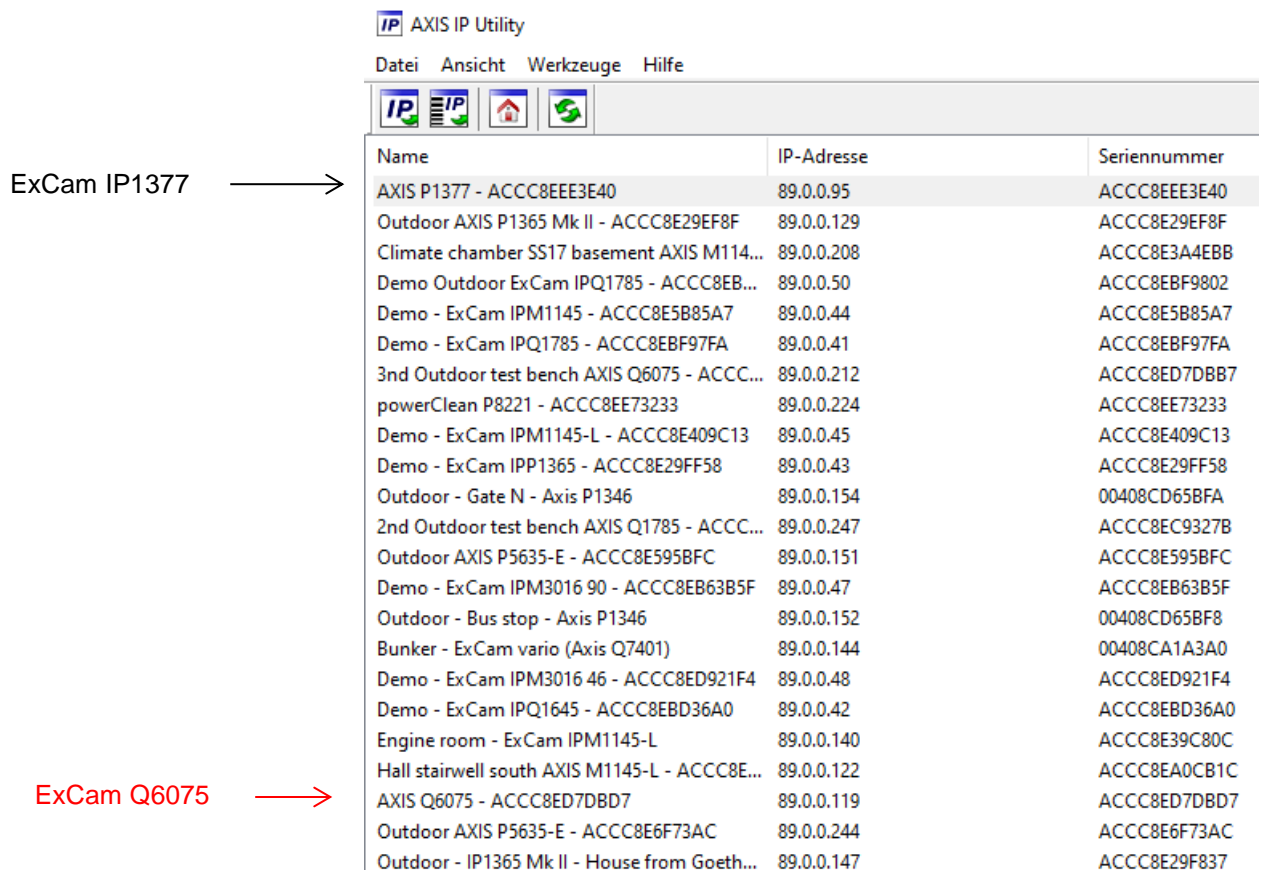

Name	IP-Adresse	Seriennummer
AXIS P1377 - ACCC8EEE3E40	89.0.0.95	ACCC8EEE3E40
Outdoor AXIS P1365 Mk II - ACCC8E29EF8F	89.0.0.129	ACCC8E29EF8F
Climate chamber SS17 basement AXIS M114...	89.0.0.208	ACCC8E3A4EBB
Demo Outdoor ExCam IPQ1785 - ACCC8EB...	89.0.0.50	ACCC8EBF9802
Demo - ExCam IPM1145 - ACCC8E5B85A7	89.0.0.44	ACCC8E5B85A7
Demo - ExCam IPQ1785 - ACCC8EBF97FA	89.0.0.41	ACCC8EBF97FA
3nd Outdoor test bench AXIS Q6075 - ACCC...	89.0.0.212	ACCC8ED7DBB7
powerClean P8221 - ACCC8EE73233	89.0.0.224	ACCC8EE73233
Demo - ExCam IPM1145-L - ACCC8E409C13	89.0.0.45	ACCC8E409C13
Demo - ExCam IPP1365 - ACCC8E29FF58	89.0.0.43	ACCC8E29FF58
Outdoor - Gate N - Axis P1346	89.0.0.154	00408CD65BFA
2nd Outdoor test bench AXIS Q1785 - ACCC...	89.0.0.247	ACCC8EC9327B
Outdoor AXIS P5635-E - ACCC8E595BFC	89.0.0.151	ACCC8E595BFC
Demo - ExCam IPM3016 90 - ACCC8EB63B5F	89.0.0.47	ACCC8EB63B5F
Outdoor - Bus stop - Axis P1346	89.0.0.152	00408CD65BF8
Bunker - ExCam vario (Axis Q7401)	89.0.0.144	00408CA1A3A0
Demo - ExCam IPM3016 46 - ACCC8ED921F4	89.0.0.48	ACCC8ED921F4
Demo - ExCam IPQ1645 - ACCC8EBD36A0	89.0.0.42	ACCC8EBD36A0
Engine room - ExCam IPM1145-L	89.0.0.140	ACCC8E39C80C
Hall stairwell south AXIS M1145-L - ACCC8E...	89.0.0.122	ACCC8EA0CB1C
AXIS Q6075 - ACCC8ED7DBD7	89.0.0.119	ACCC8ED7DBD7
Outdoor AXIS P5635-E - ACCC8E6F73AC	89.0.0.244	ACCC8E6F73AC
Outdoor - IP1365 Mk II - House from Goeth...	89.0.0.147	ACCC8E29F837

Fig. 6-1 Axis IP Utility

### 7.3 Password/ Identification

The following user name is set at the factory: **root**

The following password is set at the factory: **root**

## **8 Maintenance/ Modification**

The applicable regulations for the maintenance and servicing of electrical devices in potentially explosive atmospheres must be adhered to.

The required maintenance intervals are specific to the individual devices. The operating company has to determine these intervals depending on the application parameters. The maintenance tasks especially include examination of parts on which the ignition protection depends (e.g., proper condition of the casing, seals and cable entry points). If maintenance measures are necessary they have to be initiated and/or executed.

## **9 Reparation**

Reparations must only be carried out with original parts of SAMCON Prozessleittechnik GmbH. Damaged pressure-resistant housings have to be replaced completely. In case of doubt, send the part in question back to SAMCON Prozessleittechnik GmbH.

Reparations affecting the explosion protection must only be carried out in accordance with nationally applicable regulations - by SAMCON Prozessleittechnik GmbH or by an electrician specially authorised by SAMCON Prozessleittechnik GmbH.

Rebuilding of or alterations to the devices are not permitted!

## **10 Disposal/ Recycling**

When disposing of the device, nationally applicable regulations must be observed.

This Document is subject to alterations and additions.

## 11 Drawings & 3D models

All drawings, 3D models, certificates and other information are available in the download area of the product page on our website:

<https://www.samcon.eu/en/products/network/excam-xpt-q6075/>



Analog Ex Cameras (CVBS)	<p>powered by </p> <h1>ExCam<sup>®</sup> XPT Q6075</h1> <p>The <b>ExCam XPT Q6075</b> is a powerful ex-proof dome camera of the very latest generation with a resolution of 2 megapixels (<b>1920 x 1080p</b>). The camera allows continuous 360° pan rotation and 180° tilt coverage with automatic picture rotation. A particular highlight is the precise and quick panning and tilting ability of the camera which does not only dispose of a <b>40-fold optical zoom</b> but has also an 12-fold digital zoom. Thanks to the Lightfinder-Technology you receive sharp images and superior details even in demanding light conditions.</p> <p><b>Features.</b></p> <ul style="list-style-type: none"> <li>• Broad Certification Landscape for Hazardous Areas (ATEX, IECEx &amp; EAC-Ex and more)</li> <li>• High Resolution: 1920x1080 (HDTV 1080p)</li> <li>• Powerful Motor-Zoom-Lens (40x Optical)</li> <li>• Scratch and heat resistant LEXAN Dome for perfect optical quality</li> <li>• Dynamic PTC heating concept for arctic temperatures (-50°C)</li> <li>• Equipped with automatic temperature control</li> <li>• Protection Level of IP68 (IEC 60529)</li> <li>• Lightfinder Technologies</li> <li>• Very fast and precise PAN and TILT drive (0.05° - 450°/s)</li> <li>• Pre-wired Ex-e Junction Box for Plug &amp; Play commissioning</li> </ul> <p><b>ATEX, IECEx and EAC-Ex certified Ex-proof dome camera</b></p> <p>The ExCam series is certified according to European regulations (ATEX) as well as international ones (IECEX). The housings' certification comprises ATEX group II for zone 1, 2 as well as 21 and 22 including the explosion groups IIC / IIIC. Furthermore it also disposes of EAC-Ex certification.</p> <p>During the ExCam XPT Q6075's development stage, the focus was clearly laid on security aspects as well as mechanical precision and high-quality stainless steels but also on the modular design.</p> <p><b>Media resistance and seals</b></p>
Network Ex Cameras (TCP/IP)	
ExCam IPM3016	
ExCam IPM114x	
coolJacket	
ExCam IPQ1645	
ExCam IPQ1785	
ExCam IPP5655	
Robust Cameras (non-ex)	
Ex-d Camera Enclosures	
Connection Systems	
Cables for Ex-Areas	
Mounting systems	
Accessories	
Software	
<b>Downloads:</b>	
- ExCam Comparison	
- <a href="#">Datasheet</a>	
- <a href="#">3D-Model</a>	
- <a href="#">Usermanual</a>	
- <a href="#">CAD-files (DXF)</a>	
- <a href="#">Ex Installation Manual</a>	
- <a href="#">ATEX Type Examination</a>	
- <a href="#">IECEX Cert.-of-Conformity</a>	
- <a href="#">EAC-Ex-Certification</a>	
- <a href="#">MASC (Southafrica)</a>	
- <a href="#">PESO-APPROVAL (India)</a>	
- <a href="#">EU Dec. of Conformity</a>	
- <a href="#">Optical-Quality-Test</a>	

If you wish additional technical information, please contact us at:  
[support@samcon.eu](mailto:support@samcon.eu)



# SAMCON

Schillerstraße 17, 35102 Lohra-Altenvers  
[www.samcon.eu](http://www.samcon.eu), [info@samcon.eu](mailto:info@samcon.eu)  
fon: +49 6426 9231-0, fax: - 31

