

DATA SHEET

SFP-H10GB-CUXM-BB SERIES

10G DIRECT ATTACH CABLE NETWORKING

24/7 TECHNICAL SUPPORT AT 877.877.2269 OR VISIT BLACKBOX.COM

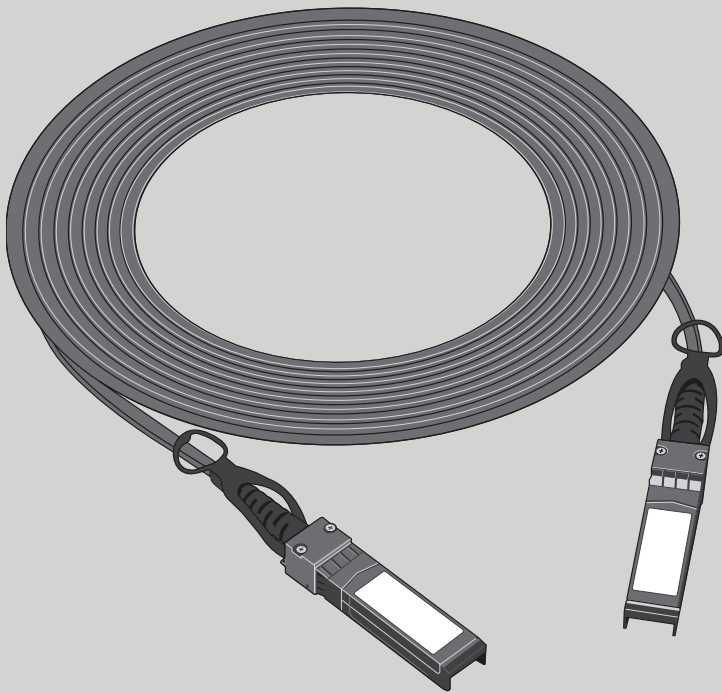

OVERVIEW

10G DIRECT ATTACH CABLE FOR NETWORKING DATA SHEET



SFP-H10GB-CU5M-BB

INTRODUCTION

Black Box® 10G Direct Attach Cables provide premium, error-free performance for data, storage, and high-performance computing (HPC) interconnectivity. 100% compatible to Cisco® SFP-H10GB-CUxM= Direct Attach Cables, these cables connect your Cisco switches, routers and servers. Constructed for full compliance with the SFP+ Multi-Source Agreement (MSA) and SFF-8431 industry standards, you can also make connections among your non-Cisco, 10G compatible networking equipment. Programmed, tested and serialized to ensure compliance and functionality, Black Box Direct Attach Cables are the ideal solution for 10G Ethernet and Fiber Channel applications and more.

Low-cost, Low-power Solution Ideal for In-Rack High-Density, High-Bandwidth Applications

When it comes to connecting networking equipment in High-Density, High-Bandwidth applications, Direct Attach Cables that operate over passive copper are the most cost-effective solution available. Perfect for inter-rack connections of switches, routers and servers, they are also an ultra-efficient solution when it comes to power. In comparison to Active Optical Cables (AOC) and modular Transceiver solutions, you can't beat the value of a low cost copper solution that consumes practically zero power.

All-in-One Solution Makes for Simple Connections with Low Latency

With an all-in-one, hot-swappable cable design, Direct Attach Cables provide you with an easy to connect solution that doesn't require purchasing multiple transceivers and cabling. The lack of additional connection points also means lower latency, so you can be confident of your data integrity. Hot-swappability makes upgrades and equipment replacements a breeze, minimizing downtime to your network connectivity.

FEATURES

- 100% COMPATIBLE TO CISCO SFP-H10GB-CUXM=
- COMPLIES WITH SFP+ MULTI-SOURCE AGREEMENT (MSA), SFF-8431, SFF-8432 AND INF8074I STANDARDS
- CONSUMES PRACTICALLY ZERO POWER, SAVING ON CONSUMPTION IN COMPARISON TO AOCs AND TRANSCEIVERS
- PERFECT FOR POINT-TO-POINT, INTRA-RACK AND RACK-TO-RACK CONNECTIONS OF 10G EQUIPMENT
- CONSTRUCTED USING CL2 RATED PVC JACKETING
- CASE SUPPORTS OPERATING TEMPERATURE RANGE OF -4 TO 158° F (-20 TO 70° C)
- LIFETIME WARRANTY



DIMENSIONAL DIAGRAMS AND SPECIFICATIONS

10G DIRECT ATTACH CABLE FOR NETWORKING DATA SHEET

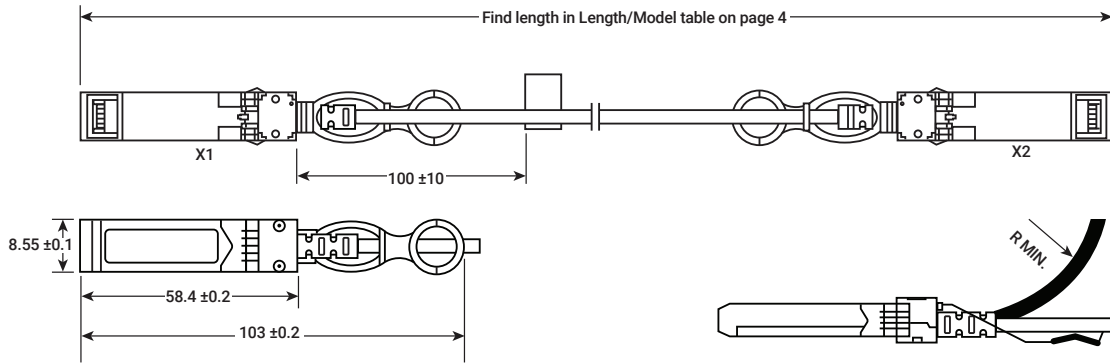

BEND RADIUS	
CABLE AWG	R MIN
30 AWG	21 MM
24 AWG	31.5 MM

PIN ASSIGNMENT		
X1	X2	Remark
X1.12	X2.19	Pair
X1.13	X2.18	
X1.14	X2.20	Drain
X1.18	X2.13	Pair
X1.19	X2.12	
X1.20	X2.14	Drain
Shell	Shell	Braid

SPECIFICATIONS AND ORDERING INFORMATION

10G DIRECT ATTACH CABLE FOR NETWORKING DATA SHEET

SPECIFICATIONS	
CONNECTOR A	SFP+ male
CONNECTOR B	SFP+ male
CABLE JACKET TYPE	CL2 rated PVC jacketing
CABLE IMPEDANCE	100 ± 10 ohms
CABLE GAUGE	30 AWG (up to 3 m)/24 AWG (up to 5 m)
COLOR	Black
DATA TRANSFER RATE	10 Gbps
NEAR-END CROSSTALK (NEXT)	<26 dB @ 5 GHz
OPERATING TEMPERATURE	-4 to 158° F (-20 to 70° C)
STORAGE TEMPERATURE	-40 to +185° F (-40 to +85° C)
POWER CONSUMPTION	0.0003 W
STANDARDS	SFP+ MSA, SFF-8431, SFF-8432, INF8074i
APPROVALS	RoHS, CE, FCC

LENGTH	MODEL
50-cm	SFP-H10GB-CU50CM-BB
1-m	SFP-H10GB-CU1M-BB
1.5-m	SFP-H10GB-CU1M5-BB
2-m	SFP-H10GB-CU2M-BB
3-m	SFP-H10GB-CU3M-BB
5-m	SFP-H10GB-CU5M-BB

DISCLAIMER

Black Box Corporation shall not be liable for damages of any kind, including, but not limited to, punitive, consequential or cost of cover damages, resulting from any errors in the product information or specifications set forth in this document and Black Box Corporation may revise this document at any time without notice.

TRADEMARKS

Black Box and the Black Box logo type and mark are registered trademarks of Black Box Corporation.

Any other trademarks mentioned in this document are acknowledged to be the property of the trademark owners.

FILENAME: SFP-H10GB-CUXM-BB_DS_REV1.PDF

© COPYRIGHT 2019. BLACK BOX CORPORATION. ALL RIGHTS RESERVED.

