



QNAP

QMiroPlus-201W

User Guide

Contents

1. Preface

About This Guide.....	4
Audience.....	4
Document Conventions.....	4

2. Product Overview

About the QMiroPlus-201W.....	5
Hardware Specifications.....	5
Software Features.....	6
Wireless Specifications.....	7
Package Contents.....	8
Components.....	8
Front Panel.....	9
Rear Panel.....	11
Safety Information.....	12

3. Installation and Access

Installation.....	14
Installation Requirements.....	14
Installing 2.5-inch Hard Drives or Solid-State Drives on 2.5-inch Trays.....	14
Connecting the Router to the Internet.....	17
Setting Up the Router.....	18
Router Access.....	19
Accessing the Router Using a Browser.....	20
Accessing the Router Using Qfinder Pro.....	20
Accessing the Router Using the QuRouter App.....	21

4. QuRouter

About QuRouter.....	22
System Requirements.....	22
Getting Started.....	22
Configuring QuRouter.....	23
Binding the Router with a QNAP ID.....	25
Unbinding the Router from a QNAP ID.....	26

5. QuRouter Navigation

Taskbar.....	27
Dashboard.....	28

6. System Configuration

System.....	29
Configuring Router Operation Modes.....	29
Configuring Access Point (AP) Mode.....	29
Locating the Router.....	30
Enabling the Router LED.....	30
Managing Logs.....	31
System Settings.....	31
Firmware.....	34
Checking for Live Updates.....	34
Updating the Firmware Manually.....	35

7. Network Settings

Configuring WAN Port Settings.....	36
Configuring LAN Port Settings.....	36
Viewing Routing Table Information.....	37
Static Route.....	37
Adding a Static Route.....	38
Configuring a Static Route.....	38
Deleting a Static Route.....	38
Wireless.....	39
Configuring Wireless Network Settings.....	39
Configuring the Guest Wireless Network.....	40
Configuring Wi-Fi Protected Setup (WPS).....	41
Clients and Blocked Clients List.....	42
Adding a Device to the Blocked List.....	42
Configuring a Device in the Blocked List.....	43
Deleting a Device from the Blocked List.....	43
Wireless Mesh Network.....	43
Adding a Node to the Mesh Network.....	44
Removing a Node from the Wireless Mesh Network.....	44
SD-WAN.....	44
About QuWAN.....	44
Configuring QuWAN Settings.....	45
Accessing QuWAN Orchestrator.....	47
QVPN.....	47
QVPN Server Settings.....	47
QVPN Client Settings.....	51
Managing QVPN Logs.....	52
Service Port Management.....	52
Adding a Custom Service Port.....	53
Deleting a Custom Service Port.....	53
DDNS Settings.....	54
Configuring DDNS (My DDNS) Settings.....	54
Modifying the DDNS Domain Name.....	54

8. Security Settings

Network Address Translation (NAT).....	55
Application Layer Gateway (ALG).....	55
Port Forwarding.....	55
Demilitarized Zone (DMZ).....	56
Discovery Settings.....	57
Configuring Universal Plug and Play (UPnP).....	57
Parental Controls.....	58
Adding a Parental Control Role.....	58
Configuring a Parental Control Role.....	58
Deleting a Parental Control Rule.....	59
Adding a Device to a Parental Control Role.....	59
Deleting a Device from a Parental Control Role.....	59

9. QuRouter App

QuRouter.....	60
System Requirements.....	60
Configuring the Router Using the QuRouter App.....	60
Overview.....	63

10. QTS Management

QTS Access..... 67
 Configuring the QTS Quick Start Wizard..... 68
 Performing QTS Power Actions..... 71
 Viewing the QTS System Information..... 71

11. Troubleshooting

Hot-swapping Failed Drives..... 73
 Support and Other Resources..... 73

12. Glossary

myQNAPcloud..... 74
 Qfinder Pro..... 74
 QNAP ID..... 74
 QTS..... 74
 QuRouter..... 74
 QuWAN..... 74
 QuWAN Orchestrator..... 74

13. Notices

Limited Warranty..... 75
 Disclaimer..... 75
 CE Notice..... 75
 FCC Notice..... 76
 Radio Equipment Directive (RED) 2014/53/EU Article 10..... 76
 EU RoHS Statement..... 77
 ISED Compliance Statement..... 77
 Radiation Exposure Statement..... 77
 EU Directive 2002/96/EC Waste Electronic and Electrical Equipment (WEEE)..... 77
 CCC Class B Notice..... 77
 UKCA Notice..... 78

1. Preface





About This Guide

This guide provides information about the device and step-by-step instructions on installing the hardware. It also provides instructions on basic operations and troubleshooting information.

Audience

This document is intended for consumers and network administrators. This guide assumes that the user has a basic understanding of network, storage, and backup concepts.

Document Conventions

Symbol	Description
	Notes provide default configuration settings and other supplementary information.
	Important notes provide information on required configuration settings and other critical information.
	Tips provide recommendations or alternative methods of performing tasks or configuring settings.
	Warnings provide information that, when ignored, may result in potential loss, injury, or even death.

2. Product Overview

This chapter provides basic information about the QNAP device.

About the QMiroPlus-201W

The QMiroPlus-201W is QNAP's first tri-band wireless mesh network (WMN) router with built-in network-attached storage (NAS) capabilities. The QMiroPlus-201W features four internal antennas, four 1 GbE ports, and supports SD-WAN deployment. The router is equipped with NAS functions and two SATA drive bays for various application and expansion options.

You can create and manage wireless mesh networks with multiple QMiro and QMiroPlus routers using the QuRouter web interface, QTS application, or the QuRouter mobile application.

Hardware Specifications



Warning

If your QNAP product has hardware defects, return the product to QNAP or a QNAP-authorized service center for maintenance or replacement. Any attempt to repair or perform maintenance procedures on the product by you or an unauthorized third party invalidates the warranty.

QNAP is not responsible for any damage or data loss caused by unauthorized modifications and installation of unsupported third-party applications.

For details, see the [QNAP Warranty Terms and Conditions](#).



Tip

Model specifications are subject to change without prior notice. To see the latest specifications, go to <https://www.qnap.com>.

Component	QMiroPlus-201W	
	Router	Storage
Processor		
CPU	Qualcomm® IPQ4019 SoC	Intel® Celeron® J4125
Frequency	4-core 716.8 MHz	4-core 2.0 GHz
Architecture	ARM Cortex-A7	x86 64-bit
Memory		
Pre-installed memory	512 MB DDR3	4 GB DDR4
Flash memory	4 MB SPI NOR	4 GB eMMC
Storage		
Drive bays	2 x 2.5-inch SATA 3 Gbps	
Drive compatibility	<ul style="list-style-type: none"> • 2.5-inch SATA hard disk drives • 2.5-inch SATA solid-state drives 	
Hot-swapping	Supported	
Network		
Gigabit network interface	<ul style="list-style-type: none"> • Host port: 1 x 10M/100M/1G/2.5G RJ45 • 4 x 10M/100M/1G RJ45 	
Bluetooth	Bluetooth 5	

Component	QMiroPlus-201W	
	Router	Storage
Power		
Maximum power consumption	60 W	
Wireless		
Wi-Fi	Wi-Fi 5 (802.11ac)	
Antennas	4 x internal antennas	
External I/O Ports & Expansion Slots		
USB ports	2 x USB 3.2 Gen 1 Type-A ports	
Interface		
Buttons	<ul style="list-style-type: none"> • Power • Reset • Wi-Fi Protected Setup (WPS) • Storage power button 	
Dimensions		
Dimensions (H x W x D)	143.5 × 105 × 183.5 mm (5.64 x 4.13 x 7.22 in)	
Net weight	1.44 kg (3.17 lbs)	
Others		
Fans	System: 1 x 60 mm, 12V DC smart fan	
Operating temperature	0°C to 40°C (32°F to 104°F)	
Relative humidity	Non-condensing relative humidity: 5% to 95%	

**Note**

For the list of compatible drive models and expansion cards, go to <https://www.qnap.com/compatibility>.

Software Features

Feature	Description
System status and management	<ul style="list-style-type: none"> • Device connection status • Device health status • WAN status • Wireless status • Firmware schedule management
Wired network management	<ul style="list-style-type: none"> • WAN/LAN port configuration • Network port connection status • IPv4 address routing management
Security	Network Address Management (NAT) and port forwarding

Feature	Description
VPN	<ul style="list-style-type: none"> • Remote access support using L2TP, OpenVPN, and QBelt (QNAP proprietary VPN) protocols • Client IP pool management • VPN client management • Connection logs • Maximum VPN tunnels: 30
Access control	<ul style="list-style-type: none"> • Parental control • Domain Name Filtering (DNS) and content filtering
System settings	<ul style="list-style-type: none"> • Backup and restore • Restart, reset • Manage audio alerts • Local account and QNAP ID management
QuWAN	Configure organization, region, site, device name, and device role

Wireless Specifications

Specification	Description
Standards	<ul style="list-style-type: none"> • 5 GHz: IEEE 802.11ac/n/a • 2.4 GHz: IEEE 802.11ac/n/g/b
Operating frequencies	<ul style="list-style-type: none"> • 2.4 GHz • 5 GHz-1 • 5 GHz-2
Speeds	AC2200 <ul style="list-style-type: none"> • 5 GHz-1 (867 Mbps): 2 x 2 dual band (20/40/80 MHz) • 5 GHz-2 (867 Mbps): 2 x 2 single band (20/40/80 MHz) • 2.4 GHz (400 Mbps): 2 x 2 dual band (20/40 MHz)
Modes	<ul style="list-style-type: none"> • Router mode • Access point (AP) mode
Guest wireless network	<ul style="list-style-type: none"> • 1 x 5 GHz • 1 x 2.4 GHz

Specification	Description
Encryption	<ul style="list-style-type: none"> • WPA2-PSK • WPA-PSK + WPA2-PSK • WPA-Enterprise • WPA2-Enterprise • WPA2-PSK / WPA3-Personal • OWE
Wireless network management	<ul style="list-style-type: none"> • Supports MU-MIMO technology • Supports band steering for tri-band (2.4 GHz and 5 GHz band) access points • Transmission power (high, middle, and low) • 20/40/80 MHz bandwidth • Auto and custom DFS (Dynamic Frequency Selection) channels • RTS/CTS (Request to Send/Clear to Send) functions • Smart connect • Wireless scheduler • Wi-Fi Protected Setup (WPS)
Bluetooth	
Bluetooth version	Bluetooth® 5.0
Bluetooth antenna gain	3.42dBi

Package Contents

Item	Quantity
QMiroPlus-201W router	1
AC power adapter	1
Ethernet cable	1

Components

Front Panel

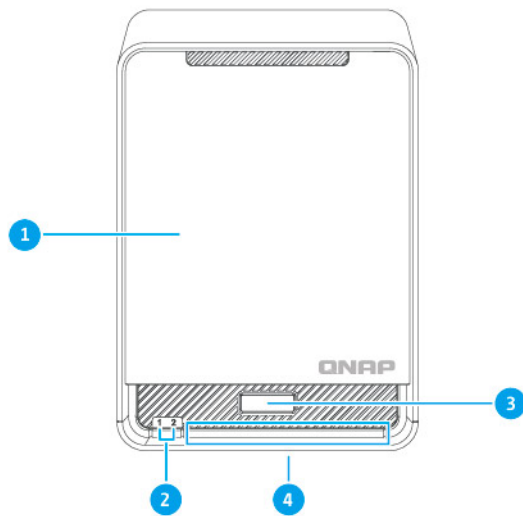

No.	Component
1	Case cover
2	Drive LEDs For details, see LEDs .
3	WPS button For details, see WPS Button .
4	Status LED For details, see LEDs .

Front Panel without Case Cover

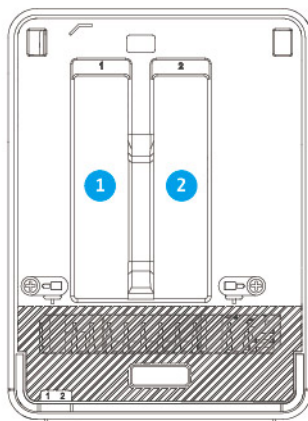

No.	Component
1	Drive bay 1
2	Drive bay 2

LEDs

LEDs indicates the overall status of the router, the drives, the storage, and the network ports.

LED	Status	Description
System Status	Green	Router initialization is complete, and the storage status is one of the following: <ul style="list-style-type: none"> • Being initialized • Powered off • Starting up
	Flashes green every 2 seconds	Router is starting up, and the storage status is one of the following: <ul style="list-style-type: none"> • Being initialized • Powered off • Starting up
	Flashes blue every 2 seconds	Router initialization is complete and the storage is ready for initialization.
	Blue	Both router and storage initializations are complete.
	Off	The router is powered off.
	Red	The router is not connected to a network.
Wireless	Flashes orange every 0.5 seconds	A node in the mesh network has a weak signal.
	Red	A node in the mesh network is out of range.
	Flashes blue every 0.5 seconds	A node is being added to the mesh network.
2.5 Gigabit Ethernet speed	Green	The network connection is operating at 2.5 Gbps.
	Orange	The network connection is operating at 1 Gbps.
	Off	<ul style="list-style-type: none"> • The network connection is operating at 100 Mbps. • The network connection is operating at 10 Mbps.
2.5 Gigabit Ethernet activity	Orange	A network connection has been established.
	Flashes orange	The router is being accessed from the network.
	Off	There is no network connection.

LED	Status	Description
Drive	Flashes red	A read/write error is occurring while data is being accessed.
	Red	A drive read/write error occurred.
	Flashes green	Data is being accessed.
	Green	The drive is ready.
	Off	No drive is detected.

WPS Button

Wi-Fi Protected Setup (WPS) is a protocol that enables a simple wireless network setup. It allows users to set up a wireless network without the need to configure any network names, passwords, or other cryptographic information.

You can configure WPS by pressing the WPS button located on the front panel of the device (see [Front Panel](#)). Alternatively, you can configure WPS through QuRouter; for details, see [Configuring Wi-Fi Protected Setup \(WPS\)](#).

Operation	User Action	Result
Enable WPS	<ol style="list-style-type: none"> 1. Press the WPS button located on the router for 3 seconds. 2. Enable WPS on the client device. <p> Tip The WPS feature may be differently labeled depending on the product. The function is typically located in the Wireless settings page.</p>	The WPS protocol is enabled and the client device joins the network.

Rear Panel

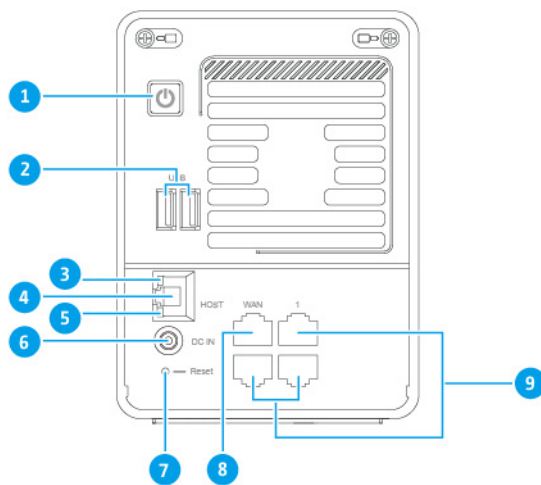

No.	Component
1	Storage power button
2	USB 3.2 Gen 1 Type-A ports
3	2.5 Gigabit Ethernet activity LED
4	2.5 Gigabit Ethernet host port
5	2.5 Gigabit Ethernet speed LED
6	Power input
7	Reset button
8	WAN port
9	LAN ports

Storage Power Button

Operation	User Action	Result
Power on	Press the button once.	The storage function is turned on.
Power off	Press and hold the button for 1.5 seconds.	The storage function is turned off.

Reset Button

QNAP routers can be reset to factory defaults using the reset button located on the rear side of the device.

For details on the component placement, see the rear side of the device ([Rear Panel](#)).

Operation	User Action	Result
Reset	Press and hold the button for 10 seconds.	The router resets and all default settings are restored. This will clear any statically assigned IP address information, WAN and LAN configurations, and security settings. The router is unbound from the QNAP ID.

Safety Information

The following instructions help ensure personal safety and environmental safety. Read these instructions carefully before performing any operations.

General Instructions

- The device should be stored in a secure location with restricted access, controlled through the use of a tool, lock and key, or any means of security.
- Only qualified, skilled, and authorized persons with knowledge of all restrictions, safety precautions, and installation and maintenance procedures should have physical access to the device.
- To avoid potential injury or damage to components, ensure that the drives and other internal system components have cooled before touching them.
- Observe electrostatic discharge (ESD) procedures to avoid potential injury or damage to components.

Power

- To reduce the risk of fire or electric shock, ensure that you only connect the power cord to a properly grounded electrical outlet.

-



Devices with redundant power supply may have one or more power supply unit (PSU) cords. To avoid serious injuries, a trained service technician must disconnect all PSU cords from the device before installing or replacing system components.

Moving Parts

-



Moving fan blades: Keep your body parts away from moving fan blades while the device is connected to a power source.

-



Moving components: Keep your body parts away from other moving components.

3. Installation and Access

This chapter provides specific hardware installation and router access steps.

Installation

Installation Requirements

Category	Item
Environment	<ul style="list-style-type: none"> Room temperature: 0°C to 40°C (32°F to 104°F) Non-condensing relative humidity: 5% to 95% Wet-bulb temperature: 27°C (80.6°F) Flat, anti-static surface without exposure to direct sunlight, liquids, or chemicals
Hardware and peripherals	Network cable
Tools	Anti-static wrist strap

Installing 2.5-inch Hard Drives or Solid-State Drives on 2.5-inch Trays

For the list of compatible drive models, go to <https://www.qnap.com/compatibility>.



Warning

- Installing a drive deletes all data on the drive.
- Observe electrostatic discharge (ESD) procedures to avoid damage to components.

•



Moving fan blades: Keep your hands and other body parts away from moving fan blades.

•



Other moving components: Keep your hands and other body parts away from other moving components.

1. Power off the device.
2. Remove the case cover.
 - a. Locate the handle beneath the case cover.
 - b. Pull the case cover handle forward.

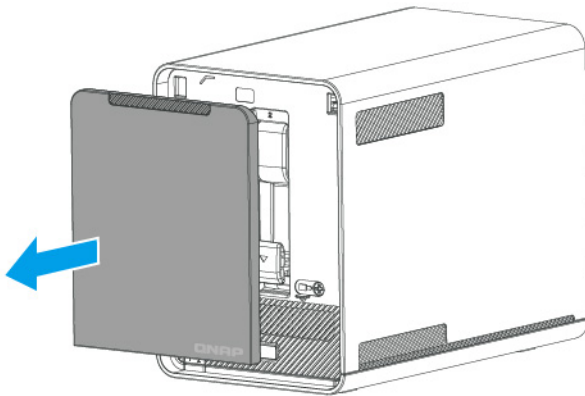

3. Remove the drive tray.

- a. Slide the lock down to release the tray.**

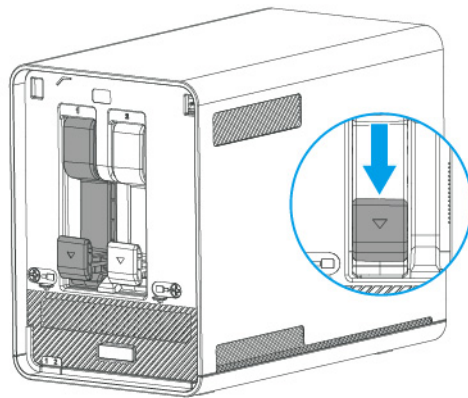

- b. Pull the tray out.**

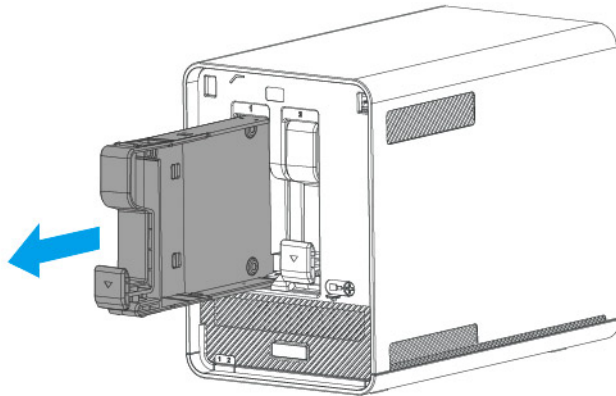

4. Install a drive on the tray.

- a.** Place the drive on the tray so that the holes on the bottom of the drive are aligned with the holes on the bottom of the tray.
- b.** Attach the screws.

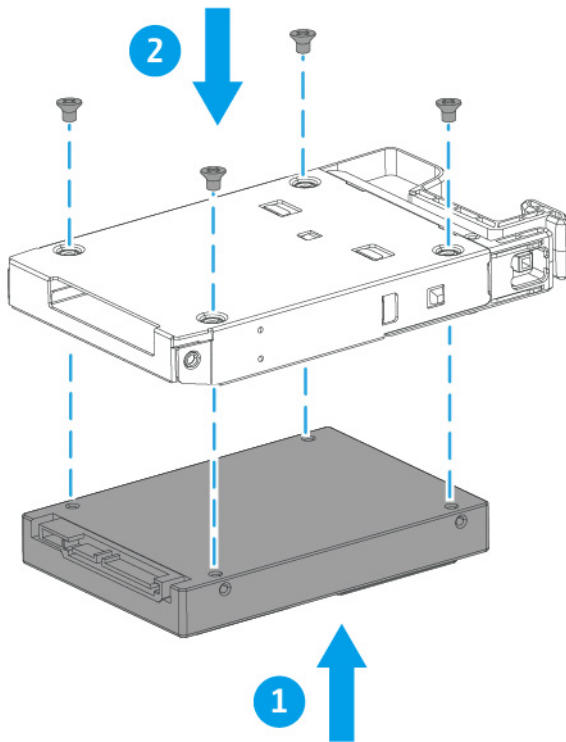

5. Load the tray into the bay.

- a. Insert the tray into the bay.

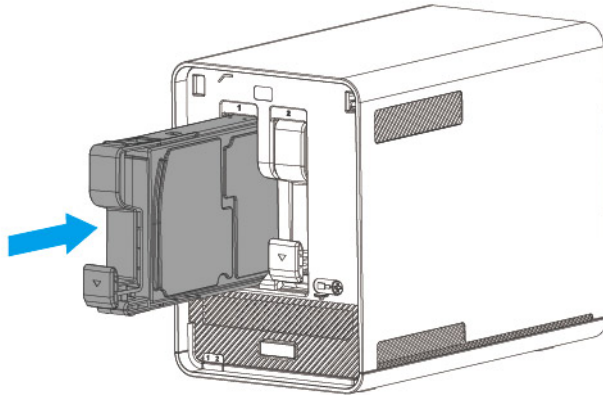

6. Attach the case cover.
 - a. Align the case cover notch with the grooves on the router.
 - b. Push the case cover back into position.

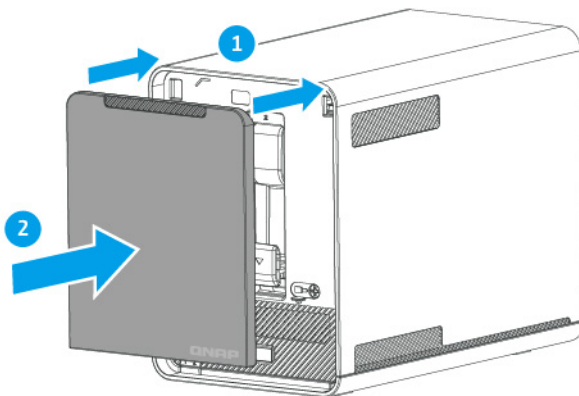

7. Power on the device.

Connecting the Router to the Internet

1. Connect the router to the power source.
 - a. Connect the power cord to the router.
 - b. Connect the power adapter to the electrical outlet.

The router powers on and the front panel LED flashes green.

2. Connect the router to the internet.
 - a. Connect an Ethernet cable to the WAN port of the router.
 - b. Connect the other end of the Ethernet cable to the ISP gateway or the modem.
3. Connect the router to the computer.
 - a. Connect an Ethernet cable to a LAN port of the router.
 - b. Connect the other end of the Ethernet cable to the Ethernet port of the computer.

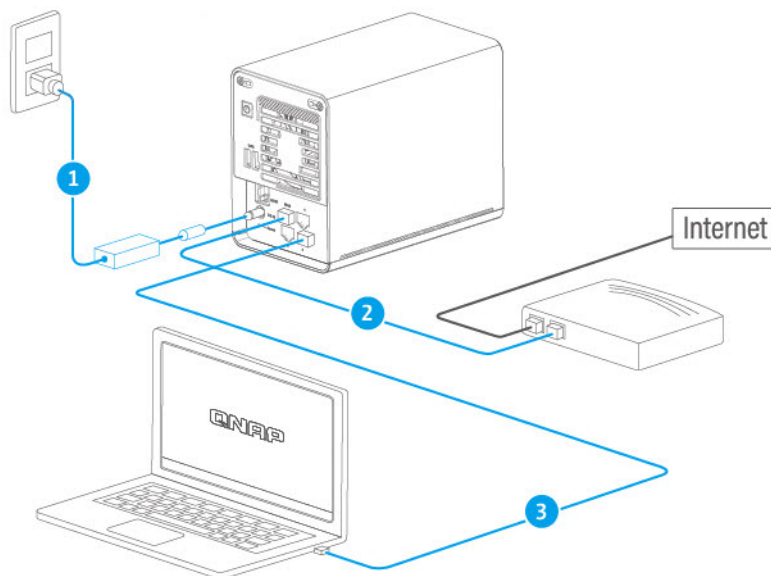

4. Open a web browser on your computer.
5. Enter 192.168.100.1 in the address bar.
The QuRouter login screen appears.
6. Follow the onscreen installation guide to configure the initial settings of the router.



Setting Up the Router

1. Place your router in an environment that meets the requirements.
For details, see [Installation Requirements](#).
2. Install the drives.
For details, see [Installing 2.5-inch Hard Drives or Solid-State Drives on 2.5-inch Trays](#).
3. Power on the router.
4. Check if the LED status is green.
For details, see [LEDs](#).
5. Connect the router to the network and the computer.

For details, see [Connecting the Router to the Internet](#).

6. Configure the router settings.
For details, see the following topics:
 - [Configuring the QTS Quick Start Wizard](#)
 - [Configuring QuRouter](#)
7. Log in with your QNAP ID or local account credentials.
For details, see [Binding the Router with a QNAP ID](#).

Router Access

Method	Description	Requirements
Web browser	<p> Important Ensure that QuRouter Remote Management is enabled in System > Access Control > Access Control Settings .</p> <p>You can access the router using any computer on the same network if you have the following information:</p> <ul style="list-style-type: none"> • Router IP address • Login credentials of a valid user account <p>Alternatively, you can access the router using the QTS IP address if you have the following information:</p> <ul style="list-style-type: none"> • QTS IP address • Login credentials of a valid user account <p> Tip The QTS IP address is listed as the NAS IP address on the asset tag of the router.</p> <ul style="list-style-type: none"> • Default username: <code>admin</code> • Default password: The NAS MAC address without any punctuation and all letters capitalized. <p>For details, see Accessing the Router Using a Browser.</p>	<ul style="list-style-type: none"> • Computer that is connected to the same network as the router • Web browser
Qfinder Pro	<p>Qfinder Pro is a desktop utility that enables you to locate and access QNAP devices on a specific network. The utility supports Windows, macOS, Linux, and Chrome OS. To download Qfinder Pro, go to https://www.qnap.com/utilities. For details, see Accessing the Router Using Qfinder Pro.</p>	<ul style="list-style-type: none"> • Computer that is connected to the same network as the router • Web browser • Qfinder Pro

Accessing the Router Using a Browser

You can access the router using any computer on the network if you know the IP address and login credentials of a valid user account.



Note

You can use Qfinder Pro to locate the router IP address.

1. Verify that your computer is connected to the same network as the router.
2. Open a web browser on your computer.
3. Enter the IP address of the router in the address bar.
4. Select the login interface.
 - QuRouter
 - QTS
5. Specify the default username and password.

Default Username	Default Password
admin	<ul style="list-style-type: none"> • QuRouter: The router MAC address without any punctuation and all letters capitalized. • QTS: The NAS MAC address without any punctuation and all letters capitalized. <div style="margin-top: 10px;">  <p>Tip For example, if the MAC address is 00:0a:0b:0c:00:01, the default password is 000A0B0C0001.</p> </div>

6. Click **Login**.
The QuRouter dashboard page appears.

Accessing the Router Using Qfinder Pro

Qfinder Pro is a desktop utility that enables you to locate and access QNAP devices on a specific network. The utility supports Windows, macOS, Linux, and Chrome OS.

1. Install Qfinder Pro on a computer that is connected to the same network as the router.
To download Qfinder Pro, go to <https://www.qnap.com/utilities>.
2. Open Qfinder Pro.
Qfinder Pro automatically searches for all QNAP devices on the network.
3. Locate the router in the list and then double-click the name or IP address.
The default web browser page opens.
4. Select the login interface.
 - QuRouter
 - QTS
5. Specify the default username and password.

Default Username	Default Password
admin	<ul style="list-style-type: none"> • QuRouter: The router MAC address without any punctuation and all letters capitalized. • QTS: The NAS MAC address without any punctuation and all letters capitalized. <div style="display: flex; align-items: flex-start; margin-top: 10px;">  <div> <p>Tip</p> <p>For example, if the MAC address is 00:0a:0b:0c:00:01, the default password is 000A0B0C0001.</p> </div> </div>

6. Click **Login**.
The home page appears.

Accessing the Router Using the QuRouter App

This process already requires you to have a configured router. To set up a new router, see [Configuring the Router Using the QuRouter App](#).

1. Open QuRouter.
To download the app on your Android or iOS device, click the following links:
 - [QuRouter for Google Play Store](#)
 - [QuRouter for iOS](#)
2. Tap **Existing Device Login**.
3. Select the region.
The QNAP ID login page appears.
4. Specify your QNAP ID and password.
5. Tap **Sign In**.

The **Overview** page appears.

4. QuRouter

About QuRouter

QuRouter is a centralized management interface that comes with your QNAP router, accessible by visiting the router's IP address in a web browser. With its intuitive interface, QuRouter makes it easy to set up, secure, and configure the features of your router.

System Requirements

Category	Details
Hardware	A QNAP router
Software	<ul style="list-style-type: none"> • Web browser: <ul style="list-style-type: none"> • Microsoft Edge 42 or later • Mozilla Firefox 60.0 or later • Apple Safari 11.1 or later • Google Chrome 70.0 or later • Qfinder Pro 6.9.2 or later

Getting Started

1. Open a web browser on your computer.
2. Enter 192.168.100.1 in the address bar.
The QuRouter login screen appears.
3. Select the login interface.
 - QuRouter
 - QTS
4. Log in with your QNAP ID or local account credentials.
For details, see [Binding the Router with a QNAP ID](#).
5. Configure network settings.
For details, see the following topics:
 - [Configuring WAN Port Settings](#)
 - [Configuring LAN Port Settings](#)
6. Configure wireless settings.
For details, see the following topics:
 - [Configuring Wireless Network Settings](#)
 - [Configuring the Guest Wireless Network](#)
 - [Configuring Wi-Fi Protected Setup \(WPS\)](#)
7. Configure system settings.

For details, see the following topics:

- [Editing the Device Name](#)
- [Configuring Access Control Settings](#)
- [Restart, Reset, Backup, and Restore](#)
- Configure audio alert settings.



Note

For details, see the Hardware section of the QTS User Guide.

8. Configure QVPN settings.

For details, see the following topics:

- [Adding a VPN User](#)
- [Enabling a QBelt VPN Server](#)
- [Enabling an L2TP VPN Server](#)
- [Enabling an OpenVPN VPN Server](#)

Configuring QuRouter

This sections explains how to configure the router using the web management interface during the initial setup process.

1. Open a web browser.
2. Enter 192.168.100.1 in the address bar.
3. Alternatively, use Qfinder Pro to locate the router on the list.
4. Double-click on the name or IP address.
The **Smart Installation Guide** page appears.
5. Click **Start**.
The **Set Up and Access QuWAN** page appears.
6. Click **OK**.
The **WAN Settings** page appears.
7. Select one of the following WAN interface settings.

Setting	Description
DHCP	Obtain IP address settings automatically via DHCP
Static IP	Manually assign a static IP address. You must specify the following information: <ul style="list-style-type: none"> • Fixed IP address • Subnet mask • DNS server
PPPoE	Select this option to specify a username and password for Point-to-Point Protocol over Ethernet (PPPoE).

8. Click **Apply**.
9. Specify the current location of the device.
 - a. Click the drop-down list to select the country or region.

**Note**

If the selected location does not match with the IP geolocation of the device, a confirmation message appears prompting you to use the router in basic wireless mode.

The basic wireless mode has the following limitations:

- The 2.4GHz band only provides access to channels 1 - 11.
- The 5 GHz bands are unavailable.
- The 2.4 GHz band operates on low output power.

- b. Click **Apply**.
QuRouter verifies the location of the device.

10. Select the Wi-Fi point of the router.

**Note**

The Wi-Fi point is the physical location of the installed router.

11. Click **Apply**.
12. Enter a new SSID and password for the router.

**Note**

You can find the default SSID and password on the rear side of the router.



13. Click **Apply**.
14. Add another router to the mesh network.
 - a. Select a router from the list.
 - b. Click **Apply**.
 - c. Select the Wi-Fi point.
 - d. Click **Apply**.
15. Update the firmware to the latest version.
For details, see [Firmware](#).

16. Click **Apply**.
A confirmation message appears.
17. Select the login interface.
 - QuRouter
 - QTS
18. Enter the default username and password.

Default Username	Default Password
admin	<ul style="list-style-type: none"> • QuRouter: The router MAC address without any punctuation and all letters capitalized. • QTS: The NAS MAC address without any punctuation and all letters capitalized. <div style="margin-top: 10px;">  Tip For example, if the MAC address is 00:0a:0b:0c:00:01, the default password is 000A0B0C0001. The MAC address can be found on the asset tag on the rear side of the device. </div>

19. Click **Login**.
The **Local Account** window appears.
20. Optional: You can log in to QuRouter using your QNAP ID and password.
For details, see [Binding the Router with a QNAP ID](#).
21. Reenter or modify the local account username and password.
22. Click **OK**.
A confirmation message appears.

QuRouter saves the settings.

To verify if QuRouter is enabled, go to **More > Help > Quick Start** and then go to the **System Volume and QuRouter** page.

Binding the Router with a QNAP ID

1. Log in to QuRouter with your QNAP ID and password.



Note

To create a new QNAP account, click **Create Account**.

2. Click **Login**.
The **Local Account** window appears.
3. Enter the local account credentials in order to complete the 2-step verification process.
4. Click **OK**.
The QuRouter dashboard opens and the **Edit Device Name** window appears.
5. Specify a device name containing between 3 to 15 alphanumeric characters.
6. Click **OK**.

The router is bound to the QNAP ID.

Unbinding the Router from a QNAP ID

1. Log in to QuRouter.
2. Go to **System > Access Control > Administrator** .
3. Below **Unbind QNAP ID**, click  .
A confirmation message appears.
4. Click **OK**.



Note

The router is unbound from the QNAP ID and you are logged out of QuRouter.

5. QuRouter Navigation





Taskbar

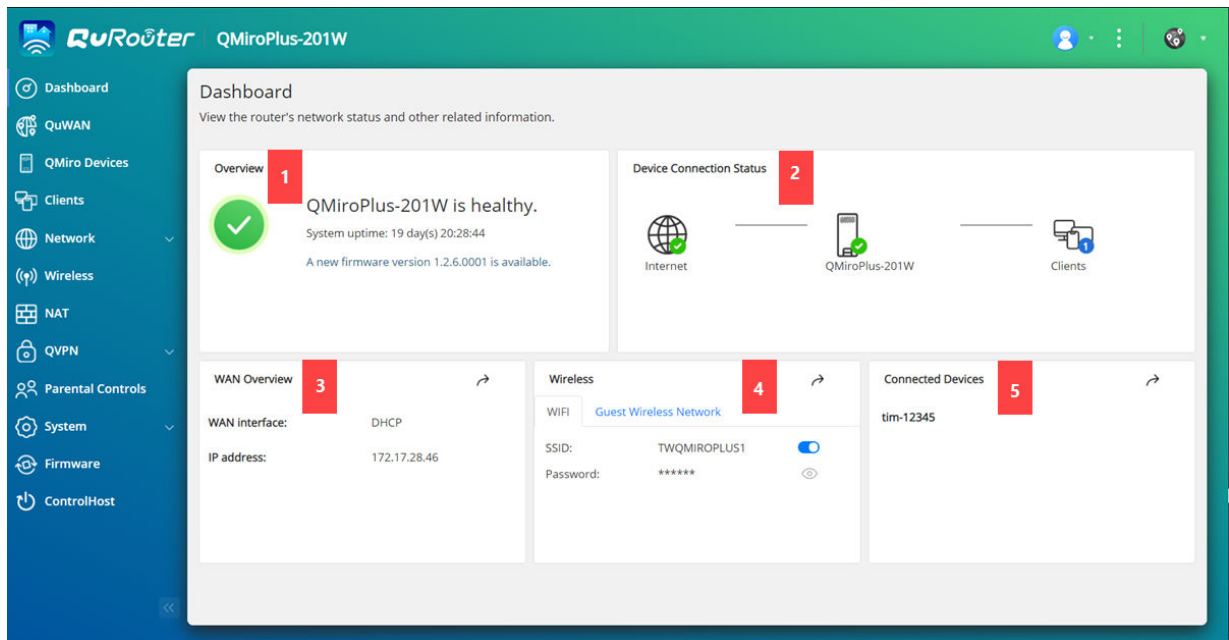

No.	Element	User Action
1	[USER_NAME]	Logout: Logs the user out of the current session
2	More	Click the button to view the following menu items: <ul style="list-style-type: none"> • Language: Opens a list of supported languages and allows you to change the language of the operating system • Domain Settings: Click to change the domain. • About: Displays the following information: <ul style="list-style-type: none"> • Operating system • Hardware model • Firmware version
3	QuWAN	<ul style="list-style-type: none"> • Click the button to view the following QuWAN-related information: <ul style="list-style-type: none"> • QuWAN Orchestrator connection status • Organization • Click QuWAN Settings to manage the QuWAN settings. • Click Go to QuWAN Orchestrator to open QuWAN Orchestrator in a new tab or window.

Dashboard



No.	Section	Displayed Information	User Action
1	Overview	<ul style="list-style-type: none"> Uptime (number of days, hours, minutes and seconds) CPU temperature Firmware information 	-
2	Device Connection Status	<ul style="list-style-type: none"> Internet status Device status Number of connected clients 	-
3	WAN Overview	<ul style="list-style-type: none"> WAN interface IP address Traffic 	Click  to open Network > WAN .
4	Wireless	Wireless / Guest Wireless Network <ul style="list-style-type: none"> SSID Password 	Click  to enable wireless or guest wireless network.  Tip Click  to make the password visible.
5	Connected Devices	Names of the connected devices	Click  to open Clients .

6. System Configuration

System

Configuring Router Operation Modes

QuRouter provides access to two router operation modes.

- **Wireless router:** The default router mode where the device can connect to the internet and share the wireless network with its client devices. NAT and DHCP are enabled by default.
- **Access point (AP):** The router connects to another wireless router using a network cable to extend the coverage of the wireless signal to other network devices. Router-related features (DHCP server, NAT, QuWAN, and WAN) are disabled when the router operates as a wireless access point. For details on configuring access point mode, see [Configuring Access Point \(AP\) Mode](#).

1. Log in to QuRouter.
2. Go to **System > Operation Mode**.
3. Select a router operation mode.
4. Click **Apply**.

QuRouter applies the operation mode settings.

Configuring Access Point (AP) Mode

Access point (AP): The router connects to another wireless router using a network cable to extend the coverage of the wireless signal to other network devices. Router-related features (DHCP server, NAT, QuWAN, and WAN) are disabled when the router operates as a wireless access point.

1. Log in to QuRouter.
2. Go to **System > Operation Mode**.
3. Select **Access point (AP) mode**.
 - a. Optional: Select **Enable Spanning Tree Protocol (STP)**.
 - b. Select one of the following IP allocation methods:
 - **DHCP:** Obtains the IP address information automatically from the DHCP server.
 - **Static IP:** Specify the IP address information manually. Configure the following static IP address settings:

Setting	User Action
Fixed IP address	Specify a fixed IP address.  Tip Examine your network setup for guidance on how to best configure these settings.
Subnet mask	Specify the subnet mask used to subdivide your IP address.
Default gateway	Specify the IP address of the default gateway for the DHCP server.
DNS server	Specify a DNS server for the DHCP server.

4. Click **Apply**.
A confirmation message appears.
5. Click **OK**.



Important

The following settings are changed when the router is switched to AP mode.

- The router is unbound from the QNAP ID.
- The router is removed from the QNAP organization and QuWAN. You must reconfigure the QuWAN settings if you enable the router mode again.

6. Run Qfinder Pro on a computer connected to the same local area network.



Note

To download Qfinder Pro, go to <https://www.qnap.com/utilities>.

7. Locate the router in the list and double-click the name or IP address.
The login screen appears.
8. Enter the local account credentials of the router.
9. Click **Login**.





Note

QuRouter displays only information related to access point settings such as network, wireless, firmware, and system settings.

Locating the Router

This section describes how to locate an on-premise router by remotely activating the LED indicator on the router.

1. Log in to QuRouter.
2. Go to **QMiro Devices**.
3. Identify the router in the QMiro Device List.
4.  Click .
The settings window appears.
5. Beside **Locate device for 5 seconds**, click **Start**.

The router LED flashes 5 times.

Enabling the Router LED

1. Log in to QuRouter.
2. Go to **QMiro Devices**.
3. Identify the router in the QMiro Device List.

4.  .
Click  .
The settings window appears.

5. Beside LED status, click  .

The router LED is enabled.

Managing Logs

Important events, errors, or warnings are recorded for the router that can be used to diagnose issues or monitor router operations. Common events include enabling or disabling network services, configuring account and system settings, and configuring security settings.

1. Log in to QuRouter.
2. Go to **System > Event Logs** .
3. Perform any of the following tasks.

Task	User Action
Search log files	<ol style="list-style-type: none"> Locate the search field. Enter search terms.
Filter event logs	Filter event logs based on the following severity levels: <ul style="list-style-type: none"> • Information • Warning • Error
Export log files	<ol style="list-style-type: none"> Click Export. A file explorer window opens. Specify the file name for saving the document. Click Save. QuRouter exports the logs as a CSV file.
Delete log files	<ol style="list-style-type: none"> Click Clear. A confirmation message appears. Click Clear.

QuRouter performs the specified task.

System Settings

Editing the Device Name

1. Log in to QuRouter.
2. Go to **System > System Settings > Device Name Settings** .

3.  .
Click  .

The **Edit Device Name** window appears.



4. Specify device name that consists of 3 to 15 characters from any of the following group:
Valid characters: A-Z, a-z, 0-9
5. Click **OK**.

QuRouter updates the device name.

Restart, Reset, Backup, and Restore

QuRouter system settings allows you to remotely control the restart, reset, backup, and restoration operations of the router.

Restarting the Router

1. Restart the router using one of the following methods.
 - **System Settings**
 1. Go to **System > System Settings > Restart / Reset / Backup / Restore** .
 2. Click **Restart**.
A confirmation message appears.
 3. Click **OK**.
 - **QMiro Devices**
 1. Go to **QMiro Devices**.
 2. Identify the router.
 3. .
Click  .
The **Settings - [Device_Name]-[Location]** window appears.
 4. Click **Restart**.
A confirmation message appears.
 5. Click **OK**.



QuRouter restarts the device.

Resetting the Router

Reset the router to restore the device to its default state.

1. Reset the router using one of the following methods.
 - **System Settings**
 1. Go to **System > System Settings > Restart / Reset / Backup / Restore** .
 2. Click **Reset**.
A confirmation message appears.
 3. Click **OK**.

- **QMiro Devices**

1. Go to **QMiro Devices**.
2. Identify the router.
3. .
Click .
The **Settings - [Device_Name]-[Location]** window appears.
4. Click **Reset**.
A confirmation message appears.
5. Click **OK**.

QuRouter resets the device to default settings and the router is unbound from the QNAP ID.



Important

Resetting the primary device resets all the nodes in the mesh network.

Backing Up System Settings

1. Go to **System > System Settings > Restart / Reset / Backup / Restore** .
2. Click **Backup**.

The device exports the system settings as a BIN file and downloads the file to your computer.

Restoring System Settings



Warning

If the selected backup file contains user or user group information that already exists on the device, the system will overwrite the existing information.

1. Go to **System > System Settings > Restart / Reset / Backup / Restore** .
2. Under **Restore**, click **Browse**.
A file explorer window opens.
3. Select a valid BIN file that contains the device system settings.
4. Click **Restore**.

QuRouter restores the router settings.

Configuring Access Control Settings

Access Control settings can control how devices connect to the router. These settings can help increase network security and minimize security threats.

1. Log in to QuRouter.
2. Go to **System > Access Control > Access Control Settings** .
3. Enable the access control settings.



Setting	User Action
Local management via HTTP	Enable to allow local access to the router web interface using non-HTTPS connections.  Note HTTP connections are faster than Hypertext Transfer Protocol Secure (HTTPS); however, the transferred content is not encrypted.
Remote management	Enable to allow administrators remote access to the router web interface via the WAN IP address.

Configuring Local Account Settings



Note

The administrator account is the default router account. You cannot delete the administrator account.

1. Log in to QuRouter.
2. Go to **System > Access Control > Administrator**.
3.  Click  to configure local account credentials. The **Local Account** window appears.
4. Configure the local account settings.

Description	User Action
Username	Specify a username that contains 5 to 32 characters. Valid characters: A-Z, a-z, 0-9
Current password	Enter the current password of the local account.
New password	Specify a password that contains 8 to 64 ASCII characters.
Confirm new password	Enter the password again.

5. Click **OK**.

QuRouter updates the local account settings.

Firmware

QNAP recommends keeping your router firmware up to date. This ensures that your router can benefit from new features, enhancements, and bug fixes.

Checking for Live Updates

1. Go to **Firmware**.
2. Enable **Live update**.
3. Select one or more of the following options:
 - **Update now**
 - **Schedule update at**

**Note**

Select the date and time to schedule the firmware update.

4. Click **Apply**.
A confirmation message appears.
5. Click **Apply**.

QuRouter checks for firmware updates.

Updating the Firmware Manually

The update may require several minutes or longer, depending on your hardware configuration and network connection.

1. Download the router firmware.
2. Go to <http://www.qnap.com/download>.
 - a. Select your router model.
 - b. Read the release notes and confirm the following:
 - The router model matches the firmware version.
 - Updating the firmware is necessary.
 - c. Ensure that the product model and firmware are correct.
 - d. Download the firmware package.
 - e. Extract the firmware package file.
3. Go to **Firmware**.
4. Select **Manual update**.
5. Click **Browse** and then select the extracted firmware package file.
6. Click **Apply**.

The device is immediately restarted.

7. Network Settings

Configuring WAN Port Settings

1. Log in to QuRouter.
2. Go to **Network > WAN**.
3. Configure the port settings.
4. Select the WAN interface setting from the following options.

Setting	User Action
DHCP	Select to obtain IP address settings automatically via DHCP
Static IP	Manually assign a static IP address. You must specify the following information: <ul style="list-style-type: none"> • Fixed IP address • Subnet mask • Default gateway • DNS server 1 • DNS server 2
PPPoE	Select to specify a username and password for Point-to-Point Protocol over Ethernet (PPPoE).

5. Specify an MTU value between 98 and 9000.



Note

The Maximum Transmission Unit (MTU) is the largest packet size that is transmitted by a network.

6. Click **Apply**.

QuRouter updates the WAN settings.

Configuring LAN Port Settings

1. Log in to QuRouter.
2. Go to **Network > LAN**.
3. Configure LAN IP settings.

Setting	User Action
Fixed IP address	Specify a fixed IP address. <div style="display: flex; align-items: flex-start; margin-top: 10px;"> <div> <p>Tip Examine your network setup for guidance on how to best configure these settings.</p> </div> </div>
Subnet Mask	Specify the subnet mask used to subdivide your IP address.

Setting	User Action
Enable DHCP server	Configure the DHCP server settings. <ul style="list-style-type: none"> • Start IP address: Specify the starting IP address in a range allocated to DHCP clients. • End IP address: Specify the ending IP address in a range allocated to DHCP clients. • Lease time: Specify the length of time that an IP address is reserved for a DHCP client. The IP address is made available to other clients when the lease expires. • Configure the DNS server settings: <ul style="list-style-type: none"> • Use the fixed IP address: Select to use the same IP address assigned for the fixed IP address. • Manually: Manually configure the DNS server IP addresses. <div style="border-left: 2px solid #0070C0; padding-left: 10px; margin-top: 10px;">  Note QNAP recommends specifying at least one DNS server to allow URL lookups. </div>
Reserved IP Table	Click Add to configure a reserved IP table. Specify the following: <ul style="list-style-type: none"> • Device name • IP address • MAC address

4. Click **Apply**.

QuRouter updates the LAN port settings.

Viewing Routing Table Information

1. Log in to QuRouter.
2. Go to **Network > Routing**.
3. View configured route entries from the following sources:
 - Directly connected networks
 - Dynamic routing protocols
 - Statically configured routes

Static Route

You can create and manage static routes in the **Static Route** section of network settings. Under normal circumstances, QuRouter automatically obtains routing information after it has been configured for internet access. Static routes are only required in special circumstances, such as having multiple IP subnets located on your network.

Adding a Static Route



1. Log in to QuRouter.
2. Go to **Network > Routing > Static Route**.
3. Click **Add Static Route**.
The **Add Static Route** window appears.
4. Configure the settings.

Setting	User Action
Destination	Specify a static IP address where connections are routed to.
Subnet Mask	Specify the IP address of the destination's subnet mask.
Next Hop	Select from the following next hop options: <ul style="list-style-type: none"> • WAN Port: Select an available WAN port IP address for the routing path. • IP Address: Specify the IP address of the closest or most optimal router in the routing path.
Metric	Specify the number of nodes that the route will pass through. <div style="display: flex; align-items: center;">  <div> <p>Note</p> <p>Metrics are cost values used by routers to determine the best path to a destination network.</p> </div> </div>
Description	Enter a description for the static route.

5. Click **Apply**.

QuRouter creates the static route.



Configuring a Static Route

1. Log in to QuRouter.
2. Go to **Network > Routing > Static Route**.
3. Identify a static route.
4.  Click .
The **Edit Static Route** window appears.
5. Configure the static route settings.
For details, see [Adding a Static Route](#).
6. Click **Apply**.

QuRouter updates the static route settings.

Deleting a Static Route

1. Log in to QuRouter.
2. Go to **Network > Routing > Static Route**.

3. Identify a static route.
4.  Click . A confirmation message appears.
5. Click **Apply**.



QuRouter deletes the static route.

Wireless

Wireless settings allow you to deploy wireless networks using the 2.4 GHz and 5 GHz band, deploy a guest wireless network, configure advanced wireless settings, and enable the WPS function.

Configuring Wireless Network Settings

1. Log in to QuRouter.
2. Go to **Wireless**.
3. Configure the wireless network settings.

Setting	User Action
Enable Smart Connect	Enable to use a single SSID and password for both 2.4 GHz and 5 GHz networks.
SSID	Specify the wireless network SSID.
Security	<p>Select one of the following security authentication methods:</p> <ul style="list-style-type: none"> • WPA2-PSK • WPA-PSK+WPA2-PSK • WPA-Enterprise • WPA2-Enterprise <p> Note Enter a Remote Authentication Dial-In User Service (RADIUS) server IP address and server port number if the security authentication method is set to WPA-Enterprise or WPA2-Enterprise.</p> <ul style="list-style-type: none"> • WPA2-PSK / WPA3-Personal • OWE
Password	<p>Specify a password that contains 8 to 63 characters.</p> <p> Note The password is case-sensitive.</p>
Enable wireless scheduler	You can select specific days and time periods to enable the VAP group.
Enable band steering	Enable to automatically reroute the wireless client to a wireless network that is utilizing the best frequency band available.
Enable MU-MIMO	Enable multiple-input, multiple-output technology (MU-MIMO) to allow the router to communicate concurrently with multiple wireless devices.

Setting	User Action
Transmission power	Select a MU-MIMO transmission power. <ul style="list-style-type: none"> • High • Medium • Low
Preamble type	Specify the preamble type. <ul style="list-style-type: none"> • Short • Long
Enable CTS/RTS	Specify a CTS/RTS value between 1 and 2347.
Enable DFS channel	Enable Dynamic Frequency Selection (DFS) to avoid interference with radar signals.

4. Configure the settings for 2.4 GHz and 5 GHz bands.



Setting	User Action
Bandwidth	Specify the bandwidth range for the following bands: <ul style="list-style-type: none"> • 2.4 GHz: <ul style="list-style-type: none"> • 20 MHz • 40 MHz • 5 GHz - 1 and 5 GHz - 2: <ul style="list-style-type: none"> • 20 MHz • 40 MHz • 80 MHz
Channels	Select the DFS channel that is less frequently used. <div style="border-left: 2px solid #0070C0; padding-left: 10px; margin-top: 10px;">  Note The channel is set to Auto by default to avoid radio frequency interference. </div>

5. Click **Apply**.

QuRouter updates the wireless network settings.

Configuring the Guest Wireless Network

1. Log in to QuRouter.
2. Go to **Wireless > Guest Wireless Network**.
3. Select **Enable**.
QuRouter enables the guest wireless network.
4. Configure the guest wireless network settings.

Setting	User Action
SSID	Specify a service set identifier (SSID) containing up to 32 characters.  Note The SSID is case-sensitive.
Security	Select one of the following security authentication methods: <ul style="list-style-type: none"> • WPA2-PSK • WPA-PSK+WPA2-PSK • WPA-Enterprise • WPA2-Enterprise  Note Enter a Remote Authentication Dial-In User Service (RADIUS) server IP address and server port number if the security authentication method is set to WPA-Enterprise or WPA2-Enterprise. <ul style="list-style-type: none"> • WPA2-PSK / WPA3-Personal • OWE
Password	Specify a password that contains 8 to 63 characters.  Note The password is case-sensitive.
Guest wireless IP address	Specify a fixed IP address for the guest wireless network.
Subnet mask	Specify the subnet mask used to subdivide your IP address

5. Configure the guest wireless DHCP server settings.

Setting	User Action
Start IP address	Specify the starting IP address in a range allocated to DHCP clients.
End IP address	Specify the ending IP address in a range allocated to DHCP clients.
DNS server 1	Specify a DNS server for the DHCP server.
DNS server 2	Specify a secondary DNS server for the DHCP server.  Important QNAP recommends specifying at least one DNS server to allow URL lookups.

6. Click **Apply**.

QuRouter saves the guest wireless network settings.

Configuring Wi-Fi Protected Setup (WPS)

1. Log in to QuRouter.
2. Go to **Wireless > WPS**.

3. Click  .
QuRouter enables the WPS function.
4. Configure the WPS settings.
 - a. Select the WPS SSID from the drop-down menu.
 - b. Click **WPS**.



Note

To enable WPS using the push button on the router, see the WPS topic.

- c. Enable the WPS function on the client device.



Note

- Ensure that the client device is equipped with the WPS function. Typically, this function is located in the Wi-Fi settings page.
- The location and feature name may differ depending on the product.

QuRouter adds the client device to the wireless network.

Clients and Blocked Clients List

The client list allows you to access wired and wireless clients connected to the router network. You can also add clients to or remove clients from the blocked list.

The blocked list controls the management of clients blocked from accessing wired and wireless services.

Adding a Device to the Blocked List

1. Log in to QuRouter.
2. Go to **Clients > Blocked List** .
3. Click **Block client**.
The **Add Device to Blocked List** window appears.
4. Configure the settings.

Setting	User Action
Description	Specify the device description. <div style="margin-top: 10px;">  <p>Note</p> <ul style="list-style-type: none"> • The description must be between 1 to 20 characters. • Valid characters: A-Z, a-z, 0-9 • Valid special characters: Hyphen (-), Underscore (_), Period (.) </div>
MAC Address	Specify the MAC address of the device.

5. Select the interface.

6. Click **Apply**.



QuRouter adds the device to the blocked list.



Tip



You can also block a client, by clicking  beside a client name in **Clients**.

Configuring a Device in the Blocked List

1. Log in to QuRouter.
2. Go to **Clients > Blocked List** .
3. Identity a device.
4.  .
Click  .
The **Edit Blocked List Device** window appears.
5. Configure the device settings.
For details, see [Adding a Device to the Blocked List](#).
6. Click **Apply**.

QuRouter updates the device information.

Deleting a Device from the Blocked List

1. Log in to QuRouter.
2. Go to **Clients > Blocked List** .
3. Identity a device.
4.  .
Click  .
A confirmation message appears.
5. Click **Apply**.

QuRouter deletes the device from the blocked list.

Wireless Mesh Network

QuRouter allows you to create wireless mesh networks by adding other QMiro series devices to the local network topology. The primary router can connect to other nodes in the network and communicate with each other to route data between clients. Wireless mesh networks adjust dynamically meet user requirements and maintain user connectivity.

Mesh Network Components

- **Primary:** The primary device is the router that is first initialized in the local network topology. This device controls the communication protocols and data routing between other node devices in the network.
- **Node:** Nodes are secondary devices added to the primary router in the local network topology.

**Tip**

You can add up to four routers in a wireless mesh network.



Adding a Node to the Mesh Network

1. Log in to QuRouter.
2. Go to **QMiro Devices**.
3. Click **Add Node**.
The **Add Node** window appears.
4. Select a router from the list.
5. Click **Next**.
6. Select a Wi-Fi point.
7. Click **Apply**.

QuRouter adds the node to the mesh network.

Removing a Node from the Wireless Mesh Network

When configuring a node as a standalone router, you must reset the node before removing it from the wireless mesh network.

1. Log in to QuRouter.
2. Go to **QMiro Devices**.
3. Identify the node.
4. .
Click .
The settings window appears.
5. Click **Reset**.
A confirmation message appears.
6. Click **OK**.

QuRouter resets the node and removes it from the wireless mesh network.

SD-WAN

About QuWAN

QuWAN is a QNAP cloud-based SD-WAN networking solution that provides a centralized control platform to manage network functions of devices within its private network topology. QuWAN can intelligently and securely direct traffic across the WAN network.

You can configure the SD-WAN settings on the router and access QuWAN Orchestrator to manage the SD-WAN overlay network.

Configuring QuWAN Settings

1. Log in to QuRouter.



Note

If you are logging in with your QNAP ID for the first time, you are prompted to enter the local account credentials as part of the 2-step verification process.

2. Go to **QuWAN > QuWAN Settings**.
3. Configure the QuWAN settings.

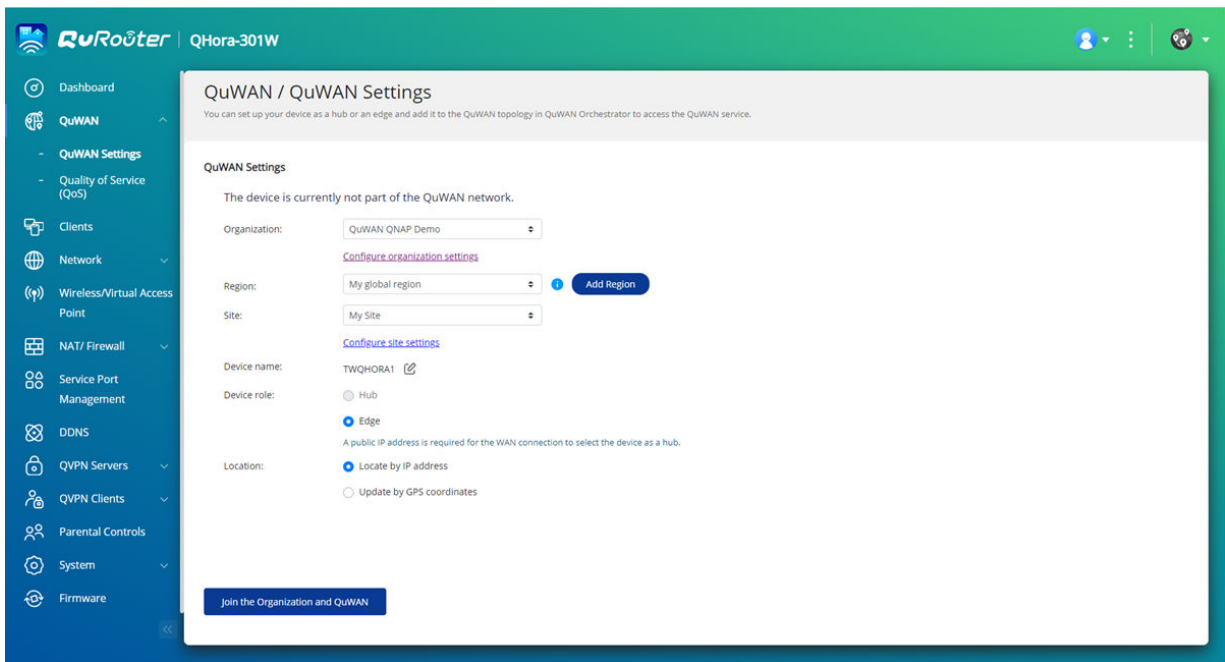

Setting	User Action
Organization	Select an organization associated with your QNAP ID. Note If there are no organizations associated with your QNAP ID, click Create or edit organization . QuRouter redirects you to QNAP Account website where you can create a new organization or edit an existing one.
Region	Select a region linked with the selected organization. Click Add Region to create a new region.
Site	Select a site from the drop-down menu. Note Click Create or edit site to create a new site associated with the selected organization or edit an existing site.
Device name	Specify a unique device name that consists of 3 to 15 characters from any of the following group. Valid characters: A-Z, a-z, 0-9

Setting	User Action
Device role	<p>Select one of the following:</p> <ul style="list-style-type: none"> • Hub: Configure the device as an SD-WAN hub. A public IP address is required for the WAN connection to select the device as a hub. • Edge: Configure the device as an SD-WAN edge. <p> Important</p> <ul style="list-style-type: none"> • You can only assign the device role of edge to devices behind NAT in an organization. • QuWAN Orchestrator automatically assigns the role of a hub to the first device added to the organization only if it is assigned a public IP address. • If the QuWAN device is using a private IP address, you can only assign the device role of edge using QuRouter. If you have enabled port forwarding on the router in front of the QuWAN device, you can change the device role from edge to hub in QuWAN Orchestrator.
Location	<p>Select one of the following:</p> <ul style="list-style-type: none"> • Locate by IP address • Update by GPS coordinates

4. Click **Join the Organization and QuWAN**.



Important

- The router is unbound from the QNAP ID once it is part of the QuWAN topology.
- A QNAP router can support up to 30 VPN tunnels.

A confirmation message appears.

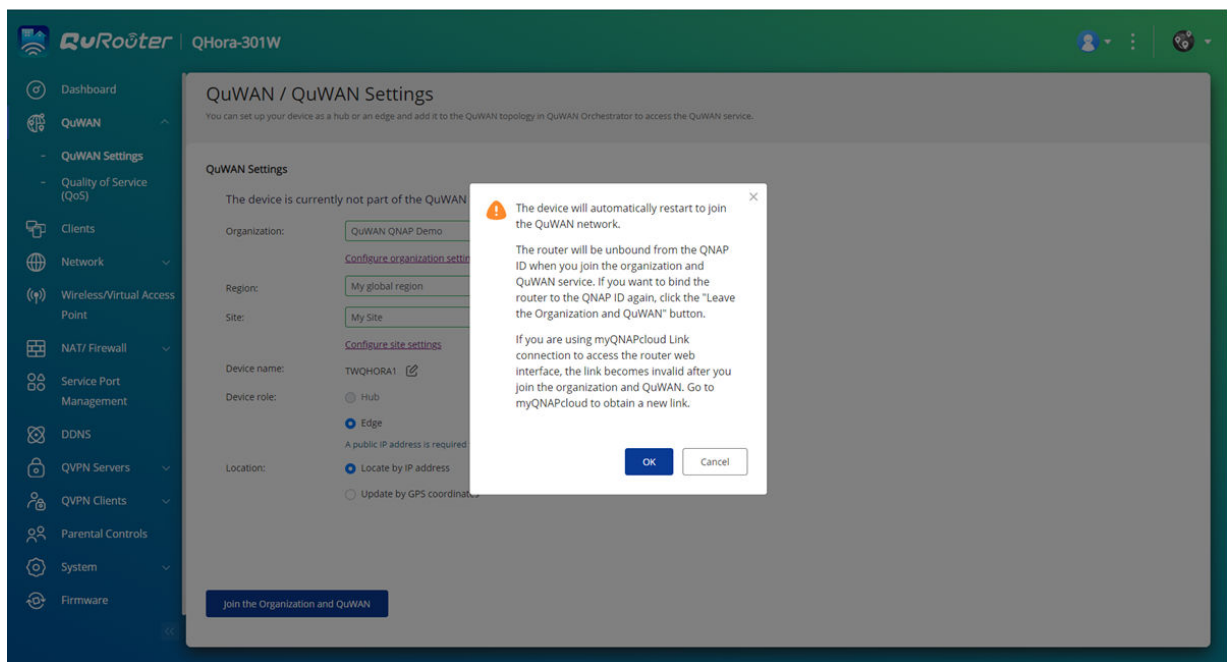

5. Click **OK**.

QuRouter adds the router to the QuWAN topology.

Accessing QuWAN Orchestrator

1. Open QuRouter.

2.



Click  located on the taskbar.

3. Click **Go to QuWAN Orchestrator**.

QuWAN Orchestrator opens in a new browser tab.

QVPN

QVPN allows you to create and manage VPN servers, add VPN clients, and monitor VPN logs.

QVPN Server Settings

QuRouter enables you to configure QNAP routers as a VPN server. You can configure multiple virtual servers to host and deliver VPN services to users in an organization.









Note

A QNAP router can support up to 30 VPN tunnels.

Enabling a QBelt VPN Server

QBelt is QNAP's proprietary communications protocol that incorporates Datagram Transfer Layer Security (DTLS) protocol and AES-256 encryption.

1. Log in to QuRouter.
2. Go to **QVPN Servers > QVPN Settings** .
3. Under QBelt, click  .
4. Click  .
The **QVPN Settings** window appears.
5. Configure the QBelt server settings.

Setting	Description
Client IP pool	Specify a range of IP addresses available to connected VPN clients.  Important By default, this server reserves the use of IP addresses between 198.18.2.2 and 198.18.2.254. If another connection is configured to use this range, an IP conflict error will occur. Before adding this server, ensure a VPN client isn't configured to use this range as well.
Service Port (UDP)	Select the port used to access the server.  Note Default port number: 4433
Pre-shared key	Specify a pre-shared key (password) to verify connecting VPN clients.  Tip Pre-shared key requirements: <ul style="list-style-type: none"> • Length: 8-16 ASCII characters • Valid characters: A-Z, a-z, 0-9
DNS	Specify a DNS server for the QBelt server.  Note The DNS server limitation is 1 by default.

6. Click **Apply**.

QuRouter saves the QBelt server settings.



Enabling an L2TP VPN Server



1. Log in to QuRouter.
2. Go to **QVPN Servers > QVPN Settings** .
3. Under L2TP, click  .



Important

You cannot enable the L2TP server if the router is using the QuWAN service. To enable the L2TP server, go to **QuWAN > QuWAN Settings** and click **Leave the organization and QuWAN**.



4.  Click  .
The **QVPN Settings** window appears.
5. Configure the L2TP server settings.

Setting	Description
Client IP pool	Specify a range of IP addresses available to connected VPN clients.  Important By default, this server reserves the use of IP addresses between 198.18.3.2 and 198.18.3.254. If another connection is configured to use this range, an IP conflict error will occur. Before adding this server, ensure a VPN client isn't configured to use this range as well.
Authentication	Select one of the following authentication methods: <ul style="list-style-type: none"> • PAP • MS-CHAPv2
Pre-shared key	Specify a pre-shared key (password) to verify connecting VPN clients.  Tip Pre-shared key requirements: <ul style="list-style-type: none"> • Length: 8–16 ASCII characters • Valid characters: A–Z, a–z, 0–9
DNS	Specify a DNS server for the L2TP server.  Note The DNS server limitation is 1 by default.

6. Click **Apply**.



QuRouter saves the L2TP server settings.

Enabling an OpenVPN VPN Server

1. Log in to QuRouter.
2. Go to **QVPN Servers > QVPN Settings** .
3. Under OpenVPN, Click  .
4.  Click  .

The **QVPN Settings** window appears.

5. Configure the OpenVPN server settings.

Setting	Description
Client IP pool	Specify a range of IP addresses available to connected VPN clients.  Important By default, this server reserves the use of IP addresses between 198.18.4.2 and 198.18.4.254. If another connection is configured to use this range, an IP conflict error will occur. Before adding this server, ensure a VPN client isn't configured to use this range as well.
Service Port	Select from the following options: <ul style="list-style-type: none"> • TCP • UDP  Note Default port number: 1194
Encryption	Select from the following encryption methods: <ul style="list-style-type: none"> • Medium (AES 128-bit) • High (AES 256-bit)
DNS	Specify a DNS server for the OpenVPN server.  Note The DNS server limitation is 1 by default.

6. Enable **Use this connection as a default gateway for remote devices**.



Note

Enable to allow the default network gateway to be redirected across the OpenVPN server. All non-local traffic from the client is transferred through the VPN server.

7. Enable **Enable compressed VPN link**.



Note

This setting compresses data before transferring it over the VPN. This will increase data transfer speeds, but requires additional CPU resources.

8. Click **Apply**.
 QuRouter saves the OpenVPN server settings.

9. Optional: Click  to download configuration files to set up an OpenVPN server manually.

Adding a VPN User

1. Open QuRouter.
2. Go to **QVPN Servers > QVPN User Management**.
3. Click **Add**.

- Specify the username and password.



Tip

Specify a password between 8 and 16 characters, containing at least one letter (A-Z, a-z) and one number (0-9).

- Click **Apply**.

QuRouter adds the VPN user.

QVPN Client Settings

The QVPN client allows the router to remotely connect to VPN servers using the OpenVPN protocol.



Important

- When adding an OpenVPN connection, an OpenVPN configuration file is required to establish the connection.
- To enable QVPN client service, ensure to disable QVPN server service and QuWAN service.

Creating an OpenVPN Connection Profile



- Open QuRouter.
- Go to **QVPN Clients > QVPN Connection Profiles**.
- Click **Add Profile**.
The **Create an OpenVPN Connection** window appears.
- Configure the OpenVPN connection profile.

Setting	User Action
OpenVPN connection profile	Add an OpenVPN configuration file. <ol style="list-style-type: none"> Click Browse. A File Explorer window opens. Locate the OpenVPN configuration file. Click Open.
OpenVPN connection profile name	Specify a name to help identify this profile.
Username	Specify the username to access the VPN server.
Password	Specify a password to access the VPN server.  <p>Tip Password requirements:</p> <ul style="list-style-type: none"> Length: 1–64 ASCII characters Valid characters: A–Z, a–z, 0–9

- Select **Automatically reconnect to OpenVPN after restarting the server**.
- Click **OK**.



QuRouter adds the QVPN connection profile.

Enabling the QVPN Client Service

1. Open QuRouter.
2. Go to **QVPN Clients > QVPN Connection Profiles** .
3. Select an active profile.
4.  .
Click  .

QuRouter enables the QVPN client service.

Deleting a QVPN Connection Profile

1. Go to **QVPN Clients > QVPN Connection Profiles** .
2. Identify a connection profile.
3.  .
Click  .
A confirmation message appears.
4. Click **Yes**.

QuRouter deletes the QVPN connection profile.



Note

Deleting an active QVPN connection profile automatically disables the QVPN client service.

Managing QVPN Logs

QuRouter records actions performed by QVPN servers and clients. Recorded information includes connection dates, connection duration, client names, source IP addresses, and protocol information.

Option	UI Path
QVPN server logs	QVPN Servers > Logs .
QVPN client logs	QVPN Clients > QVPN Connection Logs .

1. To clear QVPN logs, click **Clear Logs**.
A confirmation message appears.
2. Click **Yes**.

QuRouter clears the QVPN logs.

Service Port Management

The **Service Port Management** feature allows you to easily manage any custom network service ports on your router. You can add customized services for communication with external applications or devices.

Adding a Custom Service Port



1. Open QuRouter.
2. Go to **Service Port Management**.
3. Click **Add Custom Service**.
The **Add Custom Service** window appears.
4. Specify the custom service information.

Setting	User Action
Service name	Specify a name for the service.
Protocol	Select from the following network transport protocol: <ul style="list-style-type: none"> • All (TCP+UDP) • TCP • UDP • ESP
WAN service port	Specify a port number. <div style="border-left: 2px solid #FFD700; padding-left: 10px; margin-top: 10px;"> <p> Tip</p> <ul style="list-style-type: none"> • Ports must be between 1 - 65535 • This field can have up to 15 ports. • Separate multiple ports with commas (,) • Use hyphens (-) without a space to indicate a port range </div>
Description	Add a description for the custom service.

5. Click **Save**.

QuRouter adds the custom service port.

Deleting a Custom Service Port

1. Open QuRouter.
2. Go to **Service Port Management**.
3. Identify a custom service port.
4. .
Click .
A confirmation message appears.
5. Click **Yes**.

QuRouter deletes the custom service port.

DDNS Settings

Dynamic DNS Service (DDNS) allows internet access to the router using a domain name instead of an IP address. This ensures that the router is accessible even if the client ISP changes the IP assignment.

Configuring DDNS (My DDNS) Settings

1. Open QuRouter.
2. Go to **DDNS Settings**.
3. Click **DDNS Settings**.
The **Select WAN Interface** window appears.
4. Select the WAN interface.

Setting	User Action
WAN Interface	Select a configured WAN port.
Static IP	Manually assign a fixed IP address.
Obtain an Automatic DHCP IP Address	If the network supports DHCP, the adapter automatically obtains the IP address and network settings.

5. Click **OK**.
QuRouter updates the DDNS settings.
6. .
Click .

QuRouter enables the DDNS service.

Modifying the DDNS Domain Name

You can edit the DDNS domain name to change the address used to access the device.

1. Log in to QuRouter.
2. Go to **DDNS Settings**.
3. Click **Edit Domain Name**.
The **Edit Device Name** window appears.
4. Enter the DDNS domain name.



Note

The myQNAPcloud domain name must be between 3 and 15 characters and can contain letters (A-Z, a-z) and numbers (0-9).

5. Click **OK**.

QuRouter updates the DDNS domain name.

8. Security Settings

Network Address Translation (NAT)

NAT allows private networks that use unregistered IP addresses to connect to the internet. NAT translates private IP addresses in the internal network to public IP addresses before forwarding the packets onto another network.

Application Layer Gateway (ALG)

The ALG function allows you to implement transparent network translation on certain application layer protocols. NAT ALG supports the following protocols:

- File Transfer Protocol (FTP)
- Point-to-Point Tunneling Protocol (PPTP)
- Session Initiation Protocol (SIP)

You can enable the functionality for each protocol by enabling the switch located next to the protocol name.

Port Forwarding

You can configure port forwarding rules that can be used to direct incoming and outgoing traffic on your router to a device connected to your network.

Adding a Port Forwarding Rule



1. Go to **NAT > Port Forwarding**.
2. Click **Add Rule**.
The **Add Rule** window appears.
3. Configure the rule settings.

Setting	User Action
Protocol	Select from the following options: <ul style="list-style-type: none"> • All • TCP • UDP
WAN service port	Specify the service port for the rule.
Host IP address	Specify the LAN IP address.
LAN service port	View the LAN service port information.
Allowed remote IPs	Specify one or more remote IP addresses. <div style="border-left: 2px solid #0070C0; padding-left: 10px; margin-top: 10px;">  Note Leaving this field blank will allow access from any remote IP address. </div>
Description	Specify the rule description.

4. Click **Apply**.



QuRouter adds the rule.

Configuring a Port Forwarding Rule

1. Go to **NAT > Port Forwarding**.
2. Identify a rule.
3.  Click . The **Edit Rule** window appears.
4. Modify the port forwarding rule settings. For details, see [Adding a Port Forwarding Rule](#).
5. Click **Apply**.

QuRouter updates the port forwarding rule.

Deleting a Port Forwarding Rule

1. Go to **NAT > Port Forwarding**.
2. Identify a rule.
3.  Click . A confirmation message appears.
4. Click **Apply**.

QuRouter deletes the rule.

Demilitarized Zone (DMZ)

A Demarcation Zone or Demilitarized Zone (DMZ) creates a publicly accessible subnetwork behind your firewall. Configuring a DMZ rule allows you to add public services to your WAN without compromising the overall security of your network.



Important

You can configure DMZ rules only on configured WAN interfaces that are not in use by port forwarding rules.





Configuring DMZ Settings

1. Go to **NAT/Firewall > NAT > Demilitarized Zone (DMZ)**.
2. Identify a DMZ rule.





Note

- 1GbE WAN port 1 is used as the default interface for the DMZ rule.
- Each configured WAN port is allowed one DMZ rule.

3.  Click  .
The **DMZ Settings** window appears.
4. Specify the subnet IP address for the DMZ rule.
5. Click **Apply**.
QuRouter applies the settings.
6.  Click  .
QuRouter enables the DMZ rule.

Deleting a DMZ Rule

1. Go to **NAT/Firewall > NAT > Demilitarized Zone (DMZ)** .
2. Identify a DMZ rule.
3.  Click  .

QuRouter deletes the DMZ rule.

Discovery Settings

QuRouter enables you to locate and manage network infrastructure on your domain.





Configuring Universal Plug and Play (UPnP)

Universal Plug and Play (UPnP) is a networking protocol that enables dynamic port opening for peer-to-peer device communication on the network.



Important

Enabling UPnP makes the device discoverable on the internet and vulnerable to malware infections. Disable when not in operation.

1. Go to **NAT/Firewall > UPnP** .
2.  Click  .
The device enables the UPnP function.
3.  Beside WAN interface, click  .
The **Select WAN Interface** window appears.
4. Select the WAN port.
5. Click **OK**.

QuRouter applies the UPnP settings.



Tip

You can view the VLAN-enabled UPnP in **UPnP Service List**. By default, UPnP is enabled on VLAN 1 and the device advertises itself to plug and play devices connected to VLAN 1.

Parental Controls

QuRouter provides parental control functions to manage content filtering, safe search, and protect connected clients from inappropriate and harmful content. Network administrators can create custom parental control rules to limit internet access, block websites, and assign rules to connected devices.

Adding a Parental Control Role



1. Go to **Parental Controls**.
2. Click **Add Role**.
The **Add Role** window appears.
3. Configure the role settings.

Setting	User Action
Role name	Specify a name for the parental control role.
Enable website filter	Select this option to enable website filtering to prevent users from viewing certain URLs or websites.
Domain Name Filter	Enter an entire domain name or specific URLs. Separate multiple URLs with commas (,).
Safe Search	<p>Enable safe search to filter out explicit content in the following sites:</p> <ul style="list-style-type: none"> • YouTube <div style="border-left: 2px solid #0070C0; padding-left: 10px; margin-left: 20px;"> <p> Note You can select from the following restriction modes:</p> <ul style="list-style-type: none"> • Restricted: Completely block potentially mature and violent content. • Medium: Partially allow explicit and adult-oriented content. </div> <ul style="list-style-type: none"> • Google • Bing

4. Click **Apply**.



QuRouter creates the parental control role.

Configuring a Parental Control Role

1. Go to **Parental Controls**.
2. Identify a role.
3.  Click .
The **Edit Role** window appears.
4. Configure the parental role settings.
For details, see [Adding a Parental Control Role](#).
5. Click **Apply**.

QuRouter updates the parental control role.

Deleting a Parental Control Rule

1. Go to **Parental Controls**.
2. Identify a rule.
3.  Click  .
A confirmation message appears.
4. Click **Apply**.

QuRouter deletes the rule.

Adding a Device to a Parental Control Role





Note

You cannot assign a single device to more than one role at a time.

1. Go to **Parental Controls**.
2. Identify a role to add to a device.
3. Click **Add Device**.
The **Add Device** window appears.
4. Select a wireless device from the list.
5. Click **Add**.

QuRouter adds the device to the parental control role.

Deleting a Device from a Parental Control Role

1. Go to **Parental Controls**.
2. Identify the device to delete.
3.  Click  .
A confirmation message appears.
4. Click **OK**.

QuRouter removes the device from the parental control role.

9. QuRouter App

QuRouter

This section applies to QuRouter 1.0.0 (and later) for Android and iOS.

QuRouter is a QNAP mobile application that lets you configure and manage QMiro and QMiroPlus routers. Go to the Google Play Store or the App Store to download QuRouter for configuring your QNAP router through a mobile device.

To configure a new router, see [Configuring the Router Using the QuRouter App](#).

To add a new node to the mesh network, see [Adding a Node to the Mesh Network](#).

System Requirements

QuRouter is available on the following mobile platforms:



- Android 5.0 (or later)
- iOS 11 (or later)

Visit the Google Play Store or the Apple App Store to download the latest QuRouter version on your mobile device.

Configuring the Router Using the QuRouter App

1. Open QuRouter on your Android or iOS device.
2. Tap **Set Up New Device**.
The **Select a Device** page appears.
3. Select the QMiro device.
4. Tap **Start**.
The **Power on the Device** page appears.
5. Tap **Next**.
The **Connect to the Internet** page appears.
6. Tap **Next**.
7. Verify the LED status.
For details, see [LEDs](#).
8. Press the storage power button.
The storage functions are now accessible.
9. Tap **LED Indications** to check router LED indications and definitions.
10. Tap **Next**.
11. Connect the mobile device to the router using one of the following:

Connection	User Action
Connect via Wireless	Connect the mobile device to the router wireless function. <ol style="list-style-type: none"> a. Go to Settings > Wi-Fi on your mobile device.

	<p>b. Enable Wi-Fi.</p> <p>c. Scan for the router SSID.</p> <p>d. Tap the SSID.</p> <p>e. Enter the router password.</p> <p> Note The SSID and password are listed on the asset tag of the router.</p> <p>f. Tap Connect on Android devices or Join on iOS devices.</p> <p>g. Open the QuRouter app.</p> <p>h. Tap OK.</p>
Connect via Bluetooth	<p>Connect the mobile device to the router Bluetooth.</p> <p>a. Go to Settings > Bluetooth on your mobile device.</p> <p>b. Enable Bluetooth.</p> <p>c. Open the QuRouter app.</p> <p>d. Select the router from the list.</p> <p>e. Tap Next.</p> <p> Tip Tap  to locate your router.</p>

The mobile device connects to the router.

- 12.** Enter the last 6 alphanumeric characters of the router MAC address.



Note
The MAC address is listed on the asset tag of the router.

- 13.** Tap **Next**.

- 14.** Select the location.

- a.** Select the location of your router from the following:

- **Living Room**
- **Bedroom**
- **Office**
- **Dining Room**
- **Study**
- **Others:** Specify a customized name for the router location.

- b. Tap **Apply**.

QuRouter saves the router location.

- 15. Tap **Next**.

- 16. Configure the wireless domain settings.

- a. If the router and mobile device locations are not the same, the **Incompatible Wireless Domain Settings** window appears.

- b. Tap **OK**.

- c. Select the current location of the router.

- d. Tap **Apply**.

- 17. Specify a new SSID and password for the router.

- 18. Tap **Apply**.

A confirmation message appears informing you to connect to the updated router SSID in the Wi-Fi settings page of the mobile device.

- 19. Tap **Finish**.

The **Firmware Update** page appears.

- 20. Tap **Next**.

QuRouter updates the QTS firmware.

- 21. Click **OK**.

The **QTS Storage Settings** page appears.

- 22. Configure the QTS storage settings.



Tip

Skip this step if the storage feature is not enabled or QTS is already configured.

- a. Click **Start**.

The **Install 2.5-inch Hard Drive** page appears.

- b. Install 2.5-inch drives.

For details, see [Installing 2.5-inch Hard Drives or Solid-State Drives on 2.5-inch Trays](#).



Tip

Click **Drive compatibility list** for the list of compatible drive models.

The **Check Drive Status** page appears.

- c. Verify if the drive LED is green.

For details, see .

- d. Click **Next**.

QuRouter detects the installed disks on the router and displays a drive formatting confirmation message.

- e. Click **OK**.

QuRouter formats the installed disks and displays the **Drive Storage Settings** page.

- f. Specify the RAID type.

**Tip**

Tap the drive bay image to view the drive information.

- g. Click **Next**.
The **Storage Account Setup** page appears.
- h. Specify the storage information.

Setting	User Action
Storage name	Specify the QTS storage name. Valid characters: A-Z, a-z, 0-9
Username	Specify the username for the QTS account.
Password	Specify a QTS password that contains 8 to 14 characters.

- i. Click **Next**.
The **Completed QTS initialization** page appears.
- j. Click **Next**.
QuRouter updates the router firmware and a confirmation message appears.
- k. Click **OK**.
The QuRouter login page appears.

23. Tap **Log in with QNAP ID**.

24. Select from the following:

- **Global**
- **China**

25. Specify your QNAP ID and password.

26. Tap **Sign In**.
The **Remote Access Settings** page appears.

27. Specify the following information.

Setting	Description
Router	A unique Dynamic Domain Name System (DDNS) router name used for remote router management.
Storage	A unique DDNS storage name used for remote storage management.

28. Tap **Next**.
The **Router Setup Complete** page appears.





29. Tap **Finish**.

The **Overview** page appears.

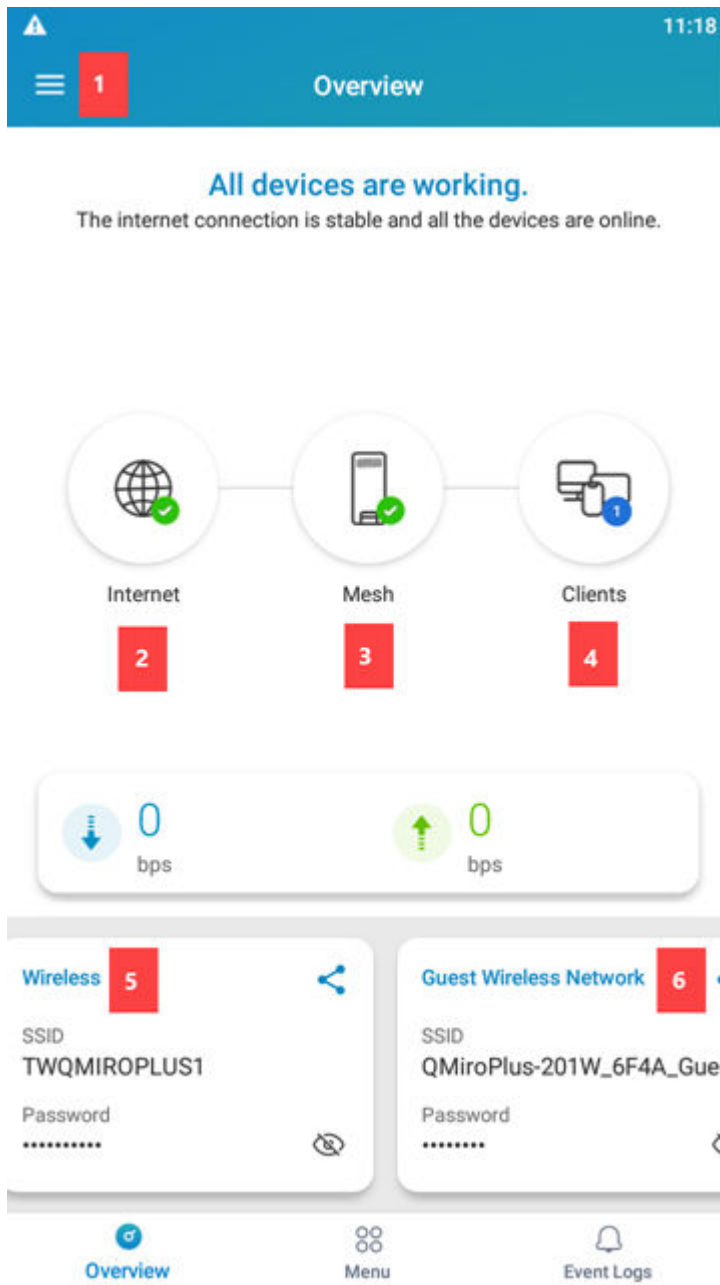
Overview

The **Overview** screen shows the connection status of all the QMiro devices in the mesh network. On this screen, you can access the wireless settings, the guest wireless settings, and the network traffic of the primary device.



No.	Description	User Action
1	More	Tap  and select an option. <ul style="list-style-type: none"> • [QNAP_ID]: Tap the QNAP ID to log out. • Install New Router: Tap to add a node to the mesh network. • About: Select the following options: <ul style="list-style-type: none"> • Feedback: Access the QNAP Feature Request / Bug Report web page • Support: Access the QNAP support page. • Disclaimer: Access the QNAP Disclaimer page.
2	Internet	Tap  to access the network settings page.
3	Mesh	Tap  to access the mesh network settings page.
4	Clients	Tap  to access the wired and wireless clients connected to the router.
5	Wireless	Tap to access the wireless settings of the router.
6	Guest Wireless Network	Tap to access the guest wireless settings of the router.

10. QTS Management

You can utilize the storage feature of the router by accessing QTS on the router. With QTS, you can synchronize and back up data between different QNAP devices.

You can also remotely restart or shut down QTS using the **QTS System Control** feature on QuRouter.

QTS Access

Method	Description	Requirements
Web browser	<p>You can access the router using the QTS IP address if you have the following information:</p> <ul style="list-style-type: none"> • QTS IP address • Login credentials of a valid user account <p> Tip The QTS IP address is listed as the NAS IP address on the asset tag of the router.</p> <ul style="list-style-type: none"> • Default username: admin • Default password: The NAS MAC address without any punctuation and all letters capitalized. 	<ul style="list-style-type: none"> • Computer that is connected to the same network as the router • Web browser

Method	Description	Requirements
Qfinder Pro	Qfinder Pro is a desktop utility that enables you to locate and access QNAP devices on a specific network. The utility supports Windows, macOS, Linux, and Chrome OS. To download Qfinder Pro, go to https://www.qnap.com/utilities . For details, see Accessing the Router Using Qfinder Pro .	<ul style="list-style-type: none"> • Computer that is connected to the same network as the router • Web browser • Qfinder Pro

Configuring the QTS Quick Start Wizard

This topic describes how to configure the Quick Start wizard to set up the storage and router functions of the QMiroPlus-201W router.

1. Log in to QTS.
 - a. Open a web browser.
 - b. Enter 192.168.100.1 in the address bar.
The web browser opens the QuRouter landing page and displays a login confirmation message.
 - c. Click **Log in to QTS**.
The QTS login page appears.
2. Enter the default username and password.

Default Username	Default Password
admin	The NAS MAC address without any punctuation and all letters capitalized. <div style="margin-top: 10px;">  Tip For example, if the MAC address is 00:0a:0b:0c:00:01, the default password is 000A0B0C0001. The MAC address can be found on the asset tag on the rear side of the device. </div>

The QTS desktop page opens and the **Quick Start** wizard automatically opens.

3. Click **Start**.
The **QuMagie** information page opens.
4. Click **QuMagie** to start the QNAP photo management service.

5. Click **Next**.
The **Data Management Apps** page opens.
6. Click the data management hyperlink to initiate the QNAP data management service.
7. Click **Next**.
The **System Volume and QuRouter** page appears.
8. Configure the storage volume settings.
To create a storage pool, see Creating a Storage Pool under Storage & Snapshots in the QTS User Guide.
 - a. Click **Storage & Snapshots**.
The Storage & Snapshots application opens and the **Data Collection Agreement** page appears.
 - b. Click **Yes**.
The **Quick Start** wizard opens.
 - c. Click **Skip** to skip the quick start wizard.
 - d. Click **Next**.
The **Use Snapshots in File Station** page appears.
 - e. Click **Next**.
The **Back up Data to Another NAS Using Snapshots** page appears.
 - f. Click **Finish**.
 - g. Go to **Storage Manager > Storage > Storage Space**.
 - h. Perform one of the following actions.

Router State	Action
No storage pools	Click New Storage Pool .
One or more storage pools	Click Create , and then select New Storage Pool .

The **Create Storage Pool Wizard** window opens.

- i. Click **Next**.
- j. Select an expansion unit from the **Enclosure Unit** list.



Important

- You cannot select disks from multiple expansion units.
- If the expansion unit is disconnected from the NAS, the storage pool becomes inaccessible until it is reconnected.

- k. Select one or more disks.



Warning

All data on the selected disks will be deleted.



Important

- For data safety, you cannot select disks that have the status **Warning**.

- The status **In Use** means that a disk is currently formatted as an external disk, and may contain current user data.

l. Select a RAID type.

Number of disks	Supported RAID Types	Default RAID Type
One	Single	Single
Two	JBOD, RAID 0, RAID 1	RAID 1



Tip

Use the default RAID type if you are unsure of which option to choose.

- m.** Click **Next**.
- n.** Configure the alert threshold.
- o.** Click **Next**.
- p.** Verify the storage pool information.
- q.** Click **Create**.
A confirmation message appears.
- r.** Click **OK**.
QTS creates the storage pool and then displays the information on the **Storage Space** screen.



Warning

Clicking **OK** deletes all data on the selected disks.

- 9.** Create a static volume in the storage pool.
 - a.** Go to **Storage > Storage/Snapshots > Storage Space** .
 - b.** Select the storage pool.
 - c.** Click **Manage**.
The **Volume Creation Wizard** window opens.
 - d.** Verify the volume location.
 - e.** Click **Next**.
 - f.** Specify the volume alias.
 - g.** Specify the volume capacity.
 - h.** Click **Next**.
The **Summary** page opens.
 - i.** Click **Finish**.
QTS creates the volume and then displays the information on the **[Volume_Name] Management** screen.
 - j.** Click **Close**.
- 10.** Open **Quick Start**.
- 11.** Verify the system volume is created on the **System Volume and QuRouter** page.

12. Click **Next**.
The **QuRouter** page appears.
13. Click **Next**.
The **Uninitialized Router** window appears.
14. Click **OK**.
The QuRouter application opens.
15. Configure QuRouter.
For details, see [Configuring QuRouter](#).

Performing QTS Power Actions

1. Select a method for accessing the **QTS System Control** feature.
 - In the QuRouter web interface, go to **Control Host**.
 - In the QTS web interface, open QuRouter and go to **Control Host**.
2. Perform the following actions on QTS.

Task	Description	Steps
Shut down QTS	Use this action to shut down the storage feature of the router.	On the QTS System Control screen: <ul style="list-style-type: none"> • Click Shut down QTS. A confirmation message appears. • Click OK. The router powers off the storage feature.
Restart QTS	Use this action to restart the storage feature of the router. When QTS becomes unresponsive, you can manually restart it.	On the QTS System Control screen: <ul style="list-style-type: none"> • Click Restart QTS. A confirmation message appears. • Click OK. The router restarts the storage feature.

QuRouter performs the specified action.

Viewing the QTS System Information

The **QTS System Control** page displays basic information regarding the storage feature of the QMiroPlus-201W router.

1. Select a method for accessing the **QTS System Control** feature.
 - In the QuRouter web interface, go to **Control Host**.
 - In the QTS web interface, open QuRouter and go to **Control Host**.
2. Check the following QTS system information:

Information	Description
CPU temperature	The current temperature of the router CPU.

Information	Description
Fan speed	The current fan speed of the router.
QTS IP address	The current QTS IP address of the router.

11. Troubleshooting

Hot-swapping Failed Drives

The router supports hot-swapping of drives in the RAID 1 configuration.

RAID Type	Number of Disks	Situation
RAID 1	2	One member drive fails.

1. Log on to QTS.
2. Go to **Main Menu > Storage & Snapshots > Storage > Disks/VJBOD** .
3. Locate the failed drive.
4. Prepare a new hard drive with a capacity that is the same as or larger than the failed hard drive.
5. Remove the failed drive from the device.
6. Wait for 20 seconds or until the device beeps twice.
7. Remove the failed drive from the drive tray.
8. Insert the new drive into the drive tray.
9. Install the new drive.
10. Go to **Main Menu > Storage & Snapshots > Storage Space** .
11. Locate the shared folder that contains the new drive and then verify that the status is *Rebuilding*.

Support and Other Resources

QNAP provides the following resources:

Resource	URL
Documentation	https://docs.qnap.com
Service Portal	https://service.qnap.com
Downloads	https://download.qnap.com
Community Forum	https://forum.qnap.com

12. Glossary

myQNAPcloud

Provides various remote access services such as DDNS and myQNAPcloud Link

Qfinder Pro

QNAP utility that lets you locate and access QNAP NAS devices in your local area network

QNAP ID

User account that enables you to use myQNAPcloud remote access and other QNAP services

QTS

QNAP NAS operating system

QuRouter

The QNAP web management interface that allows you to view and configure QNAP routers

QuWAN

QNAP SD-WAN management system

QuWAN Orchestrator

QNAP centralized management cloud platform for SD-WAN infrastructure

13. Notices

This chapter provides information about warranty, disclaimers, licensing, and federal regulations.

Limited Warranty

QNAP offers limited warranty service on our products. Your QNAP-branded hardware product is warranted against defects in materials and workmanship for a period of one (1) year or more from the date printed on the invoice. ("Warranty Period"). Please review your statutory rights at www.qnap.com/warranty, which may be amended from time to time by QNAP in its discretion.

Disclaimer

Information in this document is provided in connection with products of QNAP Systems, Inc. (the "QNAP"). No license, express or implied, by estoppels or otherwise, to any intellectual property rights is granted by this document. Except as provided in QNAP's terms and conditions of sale for such products, QNAP assumes no liability whatsoever, and QNAP disclaims any express or implied warranty, relating to sale and/or use of QNAP products including liability or warranties relating to fitness for a particular purpose, merchantability, or infringement of any patent, copyright or other intellectual property right.

QNAP products are not intended for use in medical, life saving, life sustaining, critical control or safety systems, or in nuclear facility applications.

In no event shall QNAP's liability exceed the price paid for the product from direct, indirect, special, incidental, or consequential damages resulting from the use of the product, its accompanying software, or its documentation. QNAP makes no warranty or representation, expressed, implied, or statutory, with respect to its products or the contents or use of this documentation and all accompanying software, and specifically disclaims its quality, performance, merchantability, or fitness for any particular purpose. QNAP reserves the right to revise or update its products, software, or documentation without obligation to notify any individual or entity.

Back up the system periodically to avoid any potential data loss is recommended. QNAP disclaims any responsibility of all sorts of data loss or recovery.

Should you return any components of the package of QNAP products such as NAS (Network Attached Storage) for refund or maintenance, make sure they are carefully packed for shipping. Any form of damages due to improper packaging will not be compensated.

All the features, functionality, and other product specifications are subject to change without prior notice or obligation. Information contained herein is subject to change without notice.

Further, the ® or ™ symbols are not used in the text.

CE Notice



This QNAP device complies with CE Compliance Class B.

FCC Notice

FCC Class B Notice



This device complies with Part 15 of the FCC Rules. Operation is subject to the following two conditions:

1. This device may not cause harmful interference.
2. This device must accept any interference received, including interference that may cause undesired operation.



Note

This equipment has been tested and found to comply with the limits for a Class B digital device, pursuant to Part 15 of the FCC Rules. These limits are designed to provide reasonable protection against harmful interference in a residential installation. This equipment generates, uses, and can radiate radio frequency energy and, if not installed and used in accordance with the instructions, may cause harmful interference to radio communications. However, there is no guarantee that interference will not occur in a particular installation. If this equipment does cause harmful interference to radio or television reception, which can be determined by turning the equipment off and on, the user is encouraged to try to correct the interference by one or more of the following measures:

- Reorient or relocate the receiving antenna.
- Increase the separation between the equipment and receiver.
- Connect the equipment into an outlet on a circuit different from that to which the receiver is connected.
- Consult the dealer or an experienced radio/television technician for help.



Important

Any modifications made to this device that are not approved by QNAP Systems, Inc. may void the authority granted to the user by the FCC to operate this equipment.

Radio Equipment Directive (RED) 2014/53/EU Article 10



RED 2014/53/EU requires that for products which could potentially have an issue with a non-harmonized frequency in a specific EU country, the product documentation must list the restrictions, and the packaging must carry a label reflecting that country's code.

This QNAP router complies with RED 2014/53/EU article 10.

EU RoHS Statement

This equipment complies with the European Union RoHS Directive 2011/65/EU on the restriction of the use of certain hazardous substances in electrical and electronic equipment. The directive applies to the use of lead, mercury, cadmium, hexavalent chromium, polybrominated biphenyls (PBB), and polybrominated diphenyl ethers (PBDE) in electrical and electronic equipment.

ISED Compliance Statement

Industry Canada has been renamed Innovation, Science, and Economic Development Canada (ISED) following the issue of RSP-100 Issue 11 and DC-01 Issue 06. Equipment certifications previously issued by Industry Canada remain valid and do not require updating. Meaning you may see the names used interchangeably in documentation. The following statement is applicable to ASiR-pRRH which has Innovation, Science and Economic Development (ISED) approval: This device complies with ICES-003 of Industry Canada's license-exempt RSSs. Operation is subject to the following two conditions:

1. This device may not cause interference.
2. This device must accept any interference, including interference that may cause undesired operation of the device.

Radiation Exposure Statement

This product complies with the IC radiation exposure limits set for an uncontrolled environment. To comply with RSS 102 RF exposure compliance requirements, a separation distance of at least 27 cm must be maintained between the antenna of this device and all persons. The device for the band 5150-5350 MHz is only for indoor usage to reduce potential harmful interference to co-channel mobile satellite systems.

EU Directive 2002/96/EC Waste Electronic and Electrical Equipment (WEEE)



According to the requirement of the WEEE legislation the following user information is provided to customers for all branded QNAP Electronics products subject to the WEEE directive.

This symbol on the product or on its packaging indicates that this product must not be disposed of with your other household waste. Instead, it is your responsibility to dispose of your waste equipment by handing it over to a designated collection point for the recycling of waste electrical and electronic equipment. The separate collection and recycling of your waste equipment at the time of disposal will help to conserve natural resources and ensure that it is recycled in a manner that protects human health and the environment. For more information about where you can drop off your waste equipment for recycling, please contact your local city office, your household waste disposal service or the shop where you purchased the product.

CCC Class B Notice

The following statement is applicable to products shipped to China and marked with "Class B" on the product's compliance label.

声明 此为 B 级产品。在生活环境下，它可能带来无线电干扰。如果此类情况发生，用户必须采取必要措施。此产品只用于室内。消费者若使用电源适配器供电，则应购买配套使用满足相应全标准要求电源适配器或者是获得 CCC 认证的电源适配器

UKCA Notice



This device complies with the UKCA requirements for products sold in Great Britain.