

RFD8500 USER GUIDE



RFD8500 USER GUIDE

MN002065A06

Revision A

January 2020

No part of this publication may be reproduced or used in any form, or by any electrical or mechanical means, without permission in writing from Zebra. This includes electronic or mechanical means, such as photocopying, recording, or information storage and retrieval systems. The material in this manual is subject to change without notice.

The software is provided strictly on an “as is” basis. All software, including firmware, furnished to the user is on a licensed basis. Zebra grants to the user a non-transferable and non-exclusive license to use each software or firmware program delivered hereunder (licensed program). Except as noted below, such license may not be assigned, sublicensed, or otherwise transferred by the user without prior written consent of Zebra. No right to copy a licensed program in whole or in part is granted, except as permitted under copyright law. The user shall not modify, merge, or incorporate any form or portion of a licensed program with other program material, create a derivative work from a licensed program, or use a licensed program in a network without written permission from Zebra. The user agrees to maintain Zebra’s copyright notice on the licensed programs delivered hereunder, and to include the same on any authorized copies it makes, in whole or in part. The user agrees not to decompile, disassemble, decode, or reverse engineer any licensed program delivered to the user or any portion thereof.

Zebra reserves the right to make changes to any software or product to improve reliability, function, or design. Zebra does not assume any product liability arising out of, or in connection with, the application or use of any product, circuit, or application described herein.

No license is granted, either expressly or by implication, estoppel, or otherwise under any Zebra Technologies Corporation, intellectual property rights. An implied license only exists for equipment, circuits, and subsystems contained in Zebra products.

Warranty

For the complete Zebra hardware product warranty statement, go to:

<http://www.zebra.com/warranty>.

Revision History

Changes to the original manual are listed below:

Change	Date	Description
-01 Rev A	10/2015	Initial Release
-02 Rev A	3/2016	Correct definition for Auto Reconnect Reader on page 3-10.
-03 Rev A	9/2016	Updates for Rev C software.
-04 Rev A	12/2016	Updates for Rev D software.
-05 Rev A	11/2019	Added cautionary statement to Charging the Battery in the Reader.
-06 Rev A	11/2019	Updated copyright statement. Removed Zebra RFID Mobile Application for Android chapter.

TABLE OF CONTENTS

Warranty	ii
Revision History	iii

About This Guide

Introduction	ix
Related Documents	ix
Configurations.....	x
Chapter Descriptions	xi
Notational Conventions.....	xii
Service Information.....	xii

Chapter 1: GETTING STARTED

Introduction	1-1
Unpacking	1-1
RFD8500 Features	1-2
Setting Up the RFD8500	1-4
Installing the Battery	1-4
Removing the Battery	1-7
Mounting a Mobile Device on the RFD8500	1-8
Installing the Lanyard	1-9
Charging	1-10
Charging the Battery in the Reader	1-10
Charging the Mobile Device Battery	1-11
Charging Temperature	1-11
Battery Management	1-11
Low Battery Notification	1-11
Battery Optimization	1-11
Downloading Application Software	1-12
123RFID Mobile Application for Android	1-12
Requirements	1-12
Installing the Software	1-12
Zebra RFID Mobile Application for iOS	1-12
Requirements	1-12
Installing the Software	1-12

Chapter 2: USING the RFD8500

Introduction	2-1
Using the Features on the RFD8500	2-1
Using Buttons and the Scan Trigger	2-1
LED and Beeper Indicators	2-2
Bluetooth® Wireless Technology Connections	2-3
Adaptive Frequency Hopping	2-4
Security	2-4
Pairing	2-5
Conventional Bluetooth Pairing Method	2-5
Pairing with an Android Device	2-5
Pairing with an iOS Device	2-6
Pairing with a Windows Mobile Device	2-6
Using the Locate Device Bar Code	2-7
Reading Tags	2-8
Scanning Bar Codes	2-8
Transferring Data	2-9
Transferring Data in Batch Mode	2-9
Transferring Data via Bluetooth	2-9
Transferring Data via USB	2-9

Chapter 3: 123RFID MOBILE APPLICATION for ANDROID**Chapter 4: ZEBRA RFID MOBILE APPLICATION for iOS**

Introduction	4-1
Using the Zebra RFID Mobile Application for iOS	4-1
Pairing with an iOS Device	4-2
Pairing using S/N Bar Code	4-2
Home Screen	4-3
Rapid Read	4-4
Inventory	4-5
Inventory Screen Features	4-6
Locate Tag	4-7
Settings	4-8
Readers List	4-9
Application	4-10
Antenna	4-11
Singulation Control	4-12
Start/Stop Triggers	4-13
Tag Reporting	4-14
Regulatory	4-15
Battery	4-16
Power Optimization	4-17
Beeper	4-18
Save Configuration	4-19
Locate Reader	4-20
Access Control	4-21
Read/Write	4-21
Lock	4-21
Kill	4-21

Pre Filters	4-22
Options	4-22
About	4-23

Chapter 5: ZEBRA RFID MOBILE APPLICATION for Windows

Introduction	5-1
Using the Zebra RFID Mobile Application for Windows	5-1
Home Screen	5-2
Rapid Read	5-3
Inventory	5-4
Inventory Screen Features	5-5
Locate Tag	5-6
Settings	5-7
Readers List	5-8
Application	5-9
Antenna	5-10
Singulation Control	5-11
Start/Stop Triggers	5-12
Tag Reporting	5-13
Regulatory	5-14
Battery	5-15
Power Management	5-16
Beeper	5-17
Save Configuration	5-18
Access Control	5-19
Read/Write	5-19
Lock	5-19
Kill	5-19
Pre Filters	5-20
Options	5-20
Notification Area Updates	5-21
About	5-22

Chapter 6: ZEBRA SCANNER CONTROL APPLICATION for ANDROID

Introduction	6-1
Using the Zebra Scanner Control Application for Android	6-2
Home Screen	6-2
Scanners	6-3
Scanners Screen	6-3
Connecting the Mobile Device and the Scanner	6-4
Active Scanner Screen	6-6
INFO	6-6
BARCODE	6-7
SETTINGS	6-8
Settings	6-9
Configuration (Not Supported)	6-10
About	6-11

Chapter 7: ZEBRA SCANNER CONTROL APPLICATION for iOS

Introduction	7-1
--------------------	-----

Using the Zebra Scanner Control Application for iOS Application	7-2
Home Screen	7-2
Scanners	7-3
Scanners Screen	7-3
Connecting the Device and the Scanner	7-4
Active Scanner Screen	7-5
Info	7-5
Barcode	7-6
Settings	7-6
Settings	7-7
Configuration (Not Supported by the RFD8500)	7-8
About	7-9

Chapter 8: 123SCAN

Introduction	8-1
Communication with 123Scan	8-1
123Scan Requirements	8-2
Scanner SDK, Other Software Tools, and Videos	8-2

Appendix A: TROUBLESHOOTING, TECHNICAL SPECIFICATIONS and MAINTENANCE

Introduction	A-1
Troubleshooting	A-1
Technical Specifications	A-2
Cleaning	A-2
Approved Cleanser Active Ingredients	A-2
Harmful Ingredients	A-2
Cleaning Instructions	A-3
Special Cleaning Notes	A-3
Materials Required	A-3
Cleaning Charge Connectors	A-3
Cleaning Frequency	A-4
Maintenance	A-4
RFD8500	A-4
Battery	A-4

Index

ABOUT THIS GUIDE

Introduction

The RFD8500 reader provides Radio Frequency Identification (RFID), with optional bar code scanning functionality. The unit can be used stand alone or paired with a Bluetooth® wireless technology enabled host device (such as a mobile computer and/or smartphone).

This guide provides information on using the RFD8500 and its accessories.



NOTES Some screens or windows shown in this guide may differ from the actual screens shown on the device.

This guide refers to screens and features from the Zebra RFID Mobile, and Zebra Scanner Control applications. Refer to the corresponding feature in the partner application you are using.

Related Documents

- Zebra Scanner SDK for iOS Developer Guide, p/n MN001834AXX.
- Zebra Scanner SDK for Android Developer Guide, p/n MN002223AXX.
- RFD8500 RFID Developer Guide, p/n MN002222AXX.
- RFD8500 Quick Start Guide, p/n MN002225AXX.
- RFD8500 Regulatory Guide, p/n MN002062AXX.
- CRDUNIV-RFD8500-1R Three Slot Universal Charge Only Cradle Regulatory Guide, p/n MN002224AXX.
- MC40 User Guide, p/n MN000111AXX.
- TC55 User Guide, p/n MN000015AXX.
- TC70 User Guide, p/n MN-002890-XX.
- 123RFID Mobile Application User Guide, p/n MN-003765-xx.

Configurations

Table ii-1 *RFD8500 without Imager*

Configuration	Description
RFD8500-1000100-US	BT sled, US (no imager)
RFD8500-1000100-EU	BT sled, EU (no imager)
RFD8500-1000100-JP	BT sled, Japan, high power (no imager)
RFD8500-1000110-JP	BT sled, Japan, low power (no imager)
RFD8500-1000100-IN	BT sled, India (no imager)
RFD8500-1000100-IL	BT sled, Israel (no imager)

Table ii-2 *RFD8500 with Imager*

Configuration	Description
RFD8500-5000100-US	BT sled, US (with imager)
RFD8500-5000100-EU	BT sled, EU (with imager)
RFD8500-5000100-JP	BT sled, Japan, high power (with imager)
RFD8500-5000110-JP	BT sled, Japan, low power (with imager)
RFD8500-5000100-IN	BT sled, India (with imager)
RFD8500-5000100-IL	BT sled, Israel (with imager)

Table ii-3 *Host Adapters*

Item	Part Number
Mount support - RFD8500 adapter mount for MC40 terminal	ADP-MC40-100
Mount support - RFD8500 adapter mount for TC55 terminal	ADP-TC55-100
Quad lock battery door mount and shim for iPod touch	KT-IPODTCH-100
Quad lock battery door mount for smartphones	KT-QUADOOR-100

Table ii-4 *Accessories*

Item	Part Number
AC line cord; 7.5 ft; grounded, three wire	23844-00-00R
AC line cord, 36 in.; grounded, three wire	50-16000-678R
Charging cable	CBL-TC55-CHG1-01
Cradle power supply	PWRS-14000-148C

Table ii-4 *Accessories (Continued)*

Item	Part Number
Three Slot Universal Charge Only Cradle	CRDUNIV-RFD8500-1R
Dual battery charger	SAC-TC55-2BTYC1
Lithium-ion battery 4410 mAh	BTRY-TC55-44MA1-01
Lanyard	SG-8500-HSTRPH-01
Micro USB cable	25-MCXUSB-01R
- Power supply: 100-240 VAC, 5 V, 1.2 A - Power supply: 100-240 VAC, 5V, 1.2 A with plugs. Includes four international plugs for US, UK, EU & AU - 1-slot and 4-slot charging cradles, power supplies, and line cords (DC & AC)	PWRS-124306-01R

Chapter Descriptions

This guide includes the following topics:

- [Chapter 1, GETTING STARTED](#) provides an overview of RFD8500 physical features, device illustrations and the how to get the Zebra Scanner Control and Zebra RFID Mobile applications.
- [Chapter 2, USING the RFD8500](#) describes the basic operations of RFD8500 including device behavior, Bluetooth pairing and RFID/bar code scanning features.
- [Chapter 3, 123RFID MOBILE APPLICATION for ANDROID](#) provides information about the 123RFID Mobile application for Android.
- [Chapter 4, ZEBRA RFID MOBILE APPLICATION for iOS](#) details the features of the Zebra RFID Mobile application for iOS devices.
- [Chapter 5, ZEBRA RFID MOBILE APPLICATION for Windows](#) provides information to setup a development environment for the Windows 10 Universal Windows Platform (UWP) to work with the RFD8500 over Bluetooth.
- [Chapter 6, ZEBRA SCANNER CONTROL APPLICATION for ANDROID](#) details the features of the Zebra Scanner Control application for Android devices.
- [Chapter 7, ZEBRA SCANNER CONTROL APPLICATION for iOS](#) details the features of the Zebra Scanner Control application for iOS devices.
- [Chapter 8, 123SCAN](#) includes an overview of the 123Scan utility.
- [Appendix A, TROUBLESHOOTING, TECHNICAL SPECIFICATIONS and MAINTENANCE](#) includes RFD8500 specifications, and information about troubleshooting and maintaining the reader.

Notational Conventions

This document uses the following conventions:

- *Italics* are used to highlight chapters, screen names, fields, and sections in this and related documents.
- bullets (•) indicate:
 - Action items
 - Lists of alternatives
 - Lists of required steps that are not necessarily sequential
- Sequential lists (e.g., those that describe step-by-step procedures) appear as numbered lists.



NOTE This symbol indicates something of special interest or importance to the reader. Failure to read the note will not result in physical harm to the reader, equipment or data.



CAUTION This symbol indicates that if this information is ignored, the possibility of data or material damage may occur.



WARNING! This symbol indicates that if this information is ignored the possibility that serious personal injury may occur.

Service Information

If you have a problem using the equipment, contact your facility's technical or systems support. If there is a problem with the equipment, they will contact the Zebra Technologies Global Customer Support Center at: <http://www.zebra.com/support>.

When contacting Zebra support, please have the following information available:

- Product name
- Version number
- Serial number.

Zebra responds to calls by e-mail, telephone or fax within the time limits set forth in support agreements.

If your problem cannot be solved by Zebra support, you may need to return your equipment for servicing and will be given specific directions. Zebra is not responsible for any damages incurred during shipment if the approved shipping container is not used. Shipping the units improperly can possibly void the warranty.

If you purchased your business product from a Zebra business partner, contact that business partner for support.

Chapter 1 GETTING STARTED

Introduction

This chapter provides the features of the RFD8500 and explains how to set it up for the first time.

Unpacking

Carefully remove all protective material from the RFD8500 and save the shipping container for later storage and shipping. Verify the following items are in the box:

- RFD8500
- 4410 mAh Lithium-ion battery
- Micro USB cable
- Lanyard
- Quick Start Guide
- Regulatory Guide.

Inspect the equipment for damage. If any equipment is missing or damaged, contact the Zebra Support Center immediately. See [Service Information on page xii](#) for contact information.

RFD8500 Features

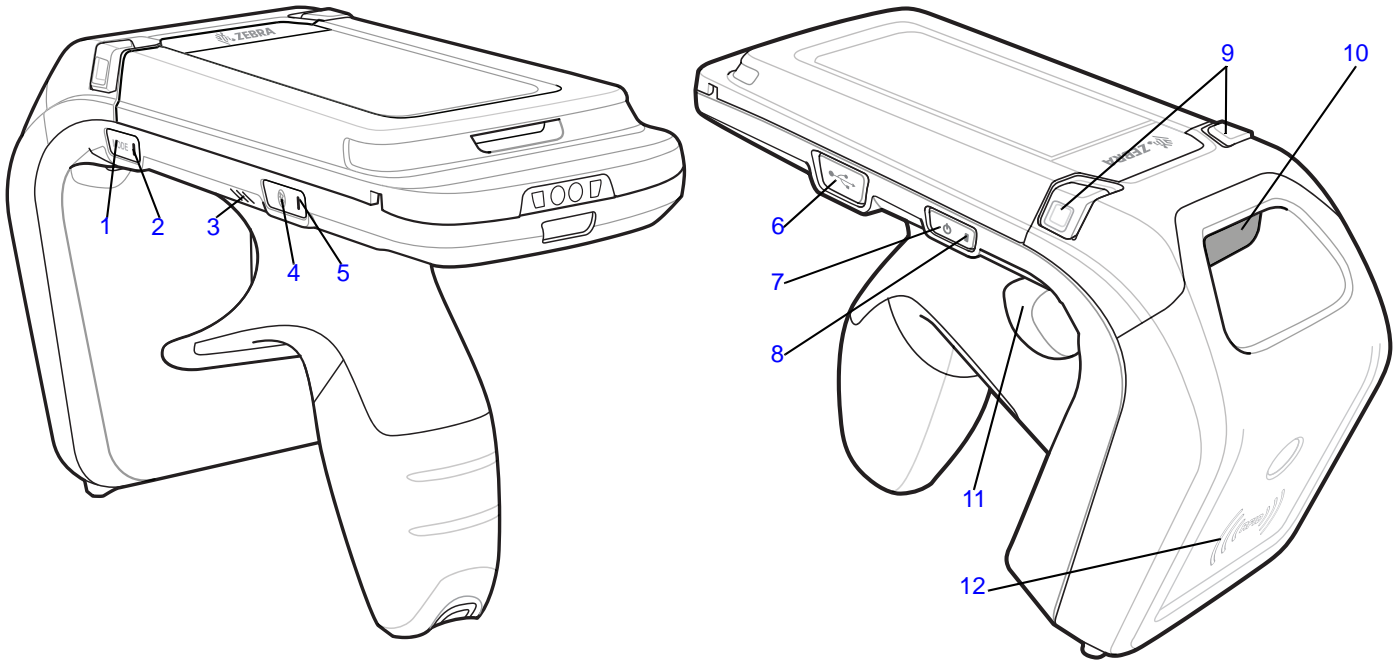

Figure 1-1 Features - Left and Right Side Views

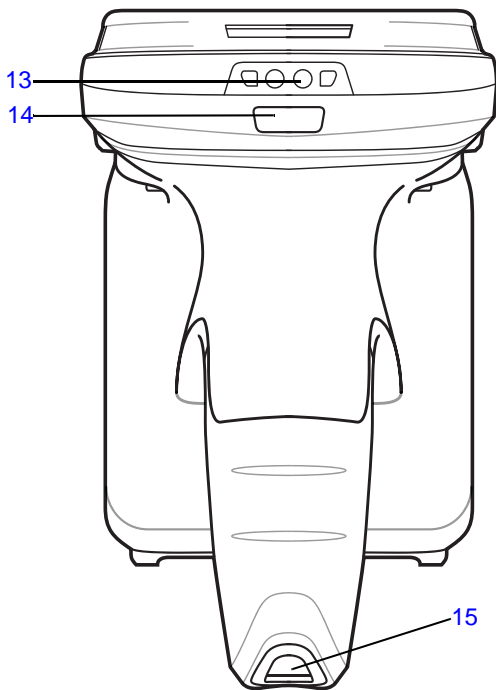

Figure 1-2 Features - Front and Back Views

See [Trigger and Button Operations on page 2-1](#) for more information about using the features.

Table 1-1 Feature Descriptions

Number	Item	Description
1	Mode Button	<ul style="list-style-type: none"> - Press to toggle between RFID and bar code modes (applicable to readers with a scanner). This button controls whether pressing the scan trigger button enables RFID or bar code function. - Press Mode and Bluetooth buttons simultaneously for three seconds to perform a soft reset. <p>The default mode is RFID.</p>
2	Mode Indicator	<p>Indicates the current mode of the reader.</p> <ul style="list-style-type: none"> • LED on (green) - Bar code mode • LED off - RFID mode.
3	Beeper	Sounds beeps that reflect the state of the RFD8500.
4	Bluetooth Button	Turns Bluetooth on and off, and enables discover mode.
5	Bluetooth Indicator	Indicates the Bluetooth status.
6	USB Port/Cover	USB port.
7	Power Button	Turns the RFD8500 on and off.
8	Power Indicator	Reflects the power state of the RFD8500. See LED and Beeper Indicators on page 2-2 for indicator descriptions.
9	Battery Cover Release Buttons	Depress buttons to remove the battery cover.
10	Imager Window (units with imager only)	Scan/read window.
11	Scan Trigger	Press to scan bar codes or read tags.
12	RFID Antenna	Houses RFID antenna.
13	Charging Contacts	Connects to a charging accessory.
14	Bar code/RFID Indicator	Lights to reflect the status of decoding bar codes/reading RFID tags.
15	Lanyard Slot	Used to install the lanyard.

Setting Up the RFD8500

To start using the RFD8500 for the first time:

- Install the battery.
- Charge the RFD8500.
- Power on the RFD8500.
- Pair the RFD8500 over Bluetooth with a mobile device.
- Install the appropriate applications: Zebra RFID Mobile, Zebra Scanner Control, or the partner application (Android or iOS).
- Set the region and power level (using the Zebra RFID Mobile application, Zebra Scanner Control application, or the partner application).

Installing the Battery

To install the battery:

1. Depress both battery cover release buttons.
2. Slide back, and remove battery cover.

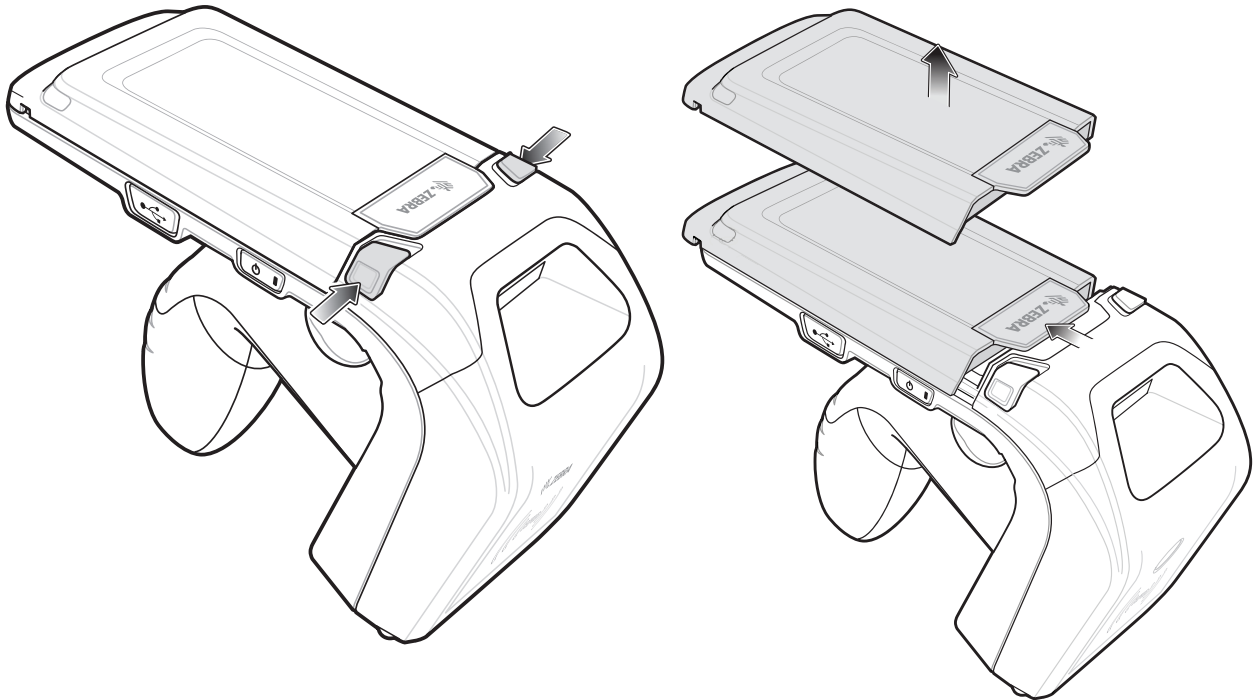

Figure 1-3 *Removing the Battery Cover*

3. Align the three tabs on the bottom of the battery (*Figure 1-5*) with the three slots in the battery compartment.

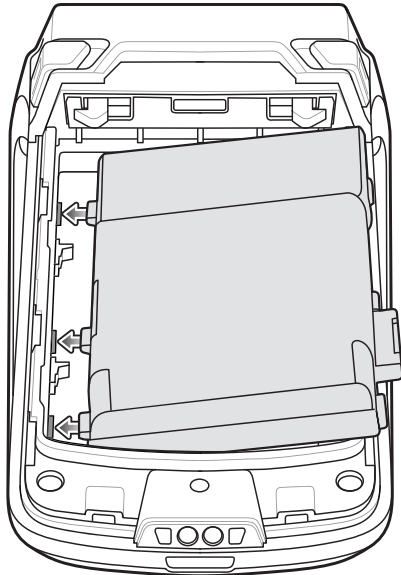

Figure 1-4 *Inserting the Battery*

4. Press the battery down and rotate until it locks into place.

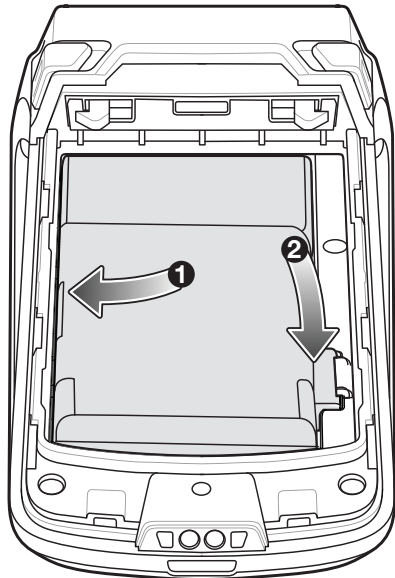

Figure 1-5 *Inserting the Battery*

5. Replace the battery cover by placing the cover over the battery and sliding it forward until it clicks in place.

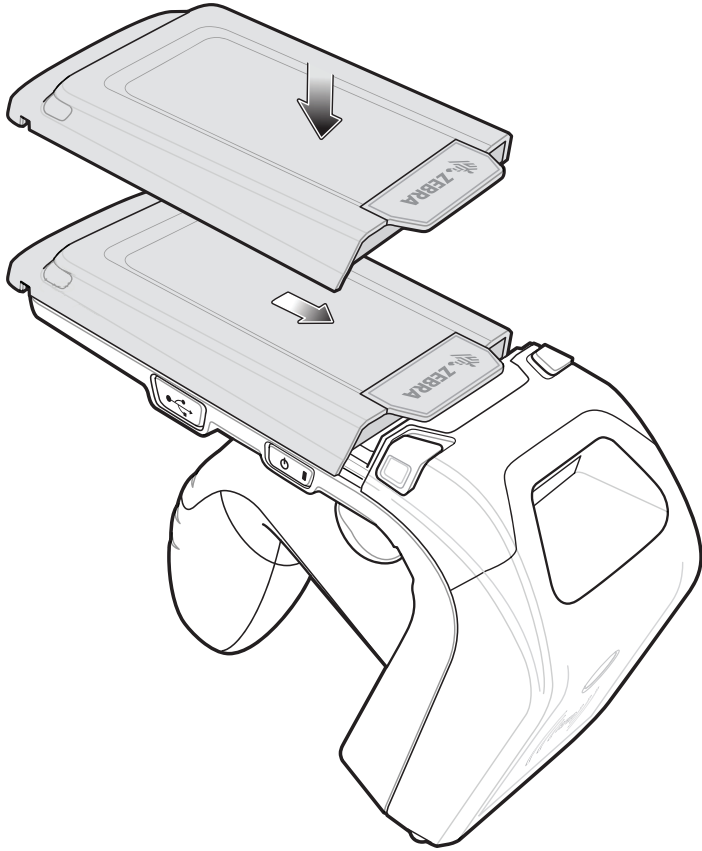

Figure 1-6 *Replacing the Battery Cover*

6. Press the **Power** button to turn on the RFD8500.

Removing the Battery

To remove the battery:

1. If powered on, press the **Power** button to power off the RFD8500.
2. Remove the battery cover as shown in [Figure 1-3 on page 1-4](#).
3. With two fingers, press the battery down.

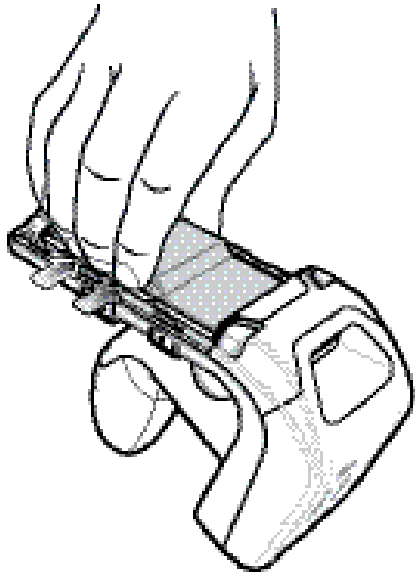

Figure 1-7 *Removing the Battery*

4. Rotate the battery out of the compartment.

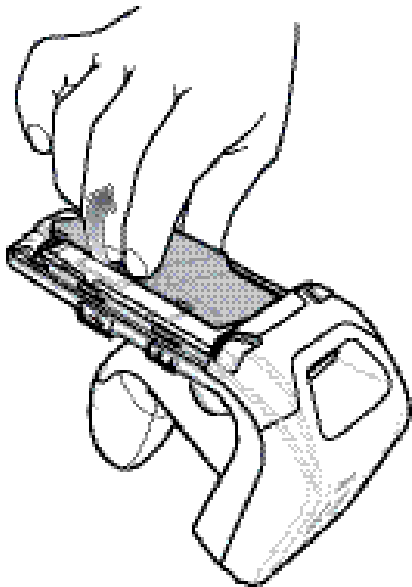

Figure 1-8 *Removing the Battery*

5. Replace the battery cover as shown in [Figure 1-6 on page 1-6](#).
6. Press the **Power** button to power on the device.

Mounting a Mobile Device on the RFD8500

To mount a mobile device:

1. Remove the battery cover as shown in [Figure 1-3 on page 1-4](#).
2. Remove the plastic tip from the RFD8500 battery cover.

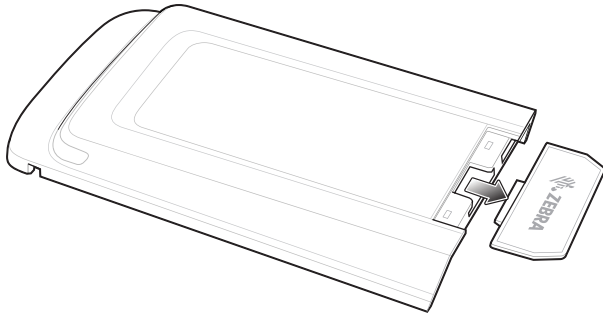
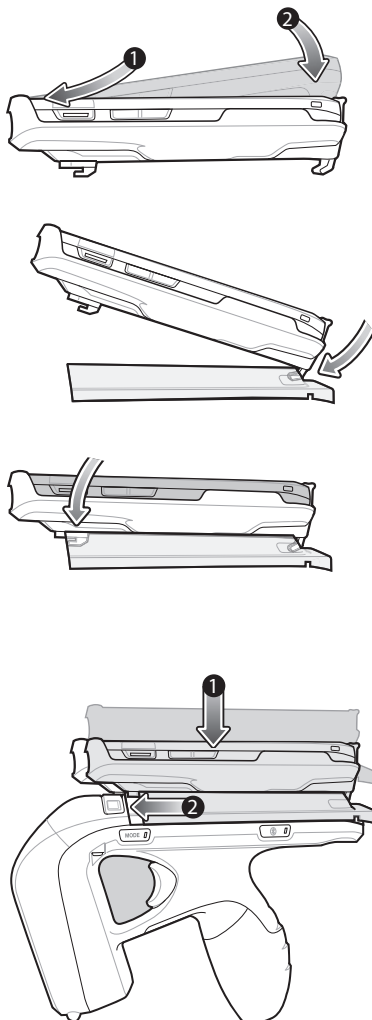
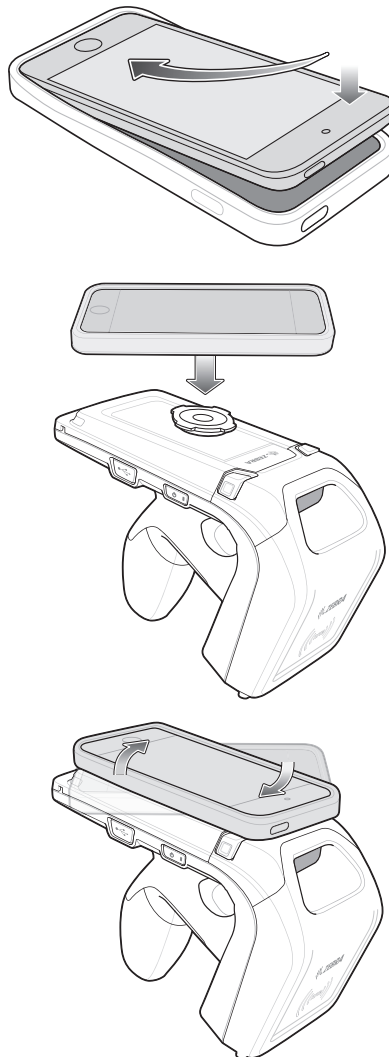

Figure 1-9 Removing Plastic Tip
Android Device (TC55 Pictured)



iOS Device (iPod touch Pictured)



3. Mount the mobile device into its case.
(Cases vary depending on the mobile device.)
4. Attach the mobile computer case to the RFD8500 battery cover.
5. Slide the battery cover onto the RFD8500 until it locks in place.
6. The battery cover latches secure the mobile computer to the RFD8500.

Figure 1-10 Mounting the Device

Installing the Lanyard

To install the optional lanyard:

1. Insert the loop on the lanyard into the slot at the bottom of the RFD8500 handle.
2. Thread the upper portion of the lanyard into the loop.
3. Pull the clip through the loop over the tether point and tighten into place.

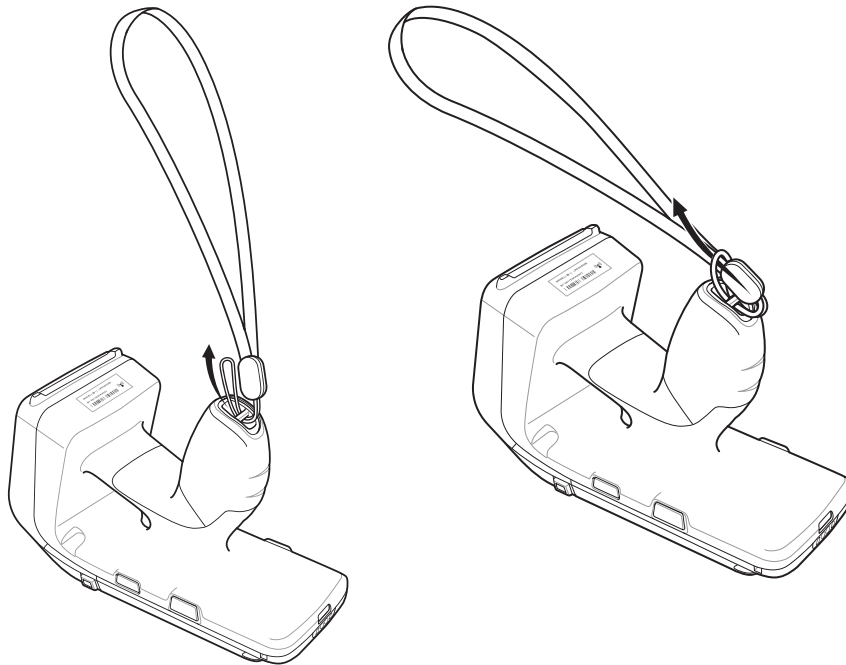

Figure 1-11 *Installing the Lanyard*

Charging

Charging the Battery in the Reader



CAUTION Ensure that you follow the guidelines for battery safety described in [Battery Management on page 1-11](#). The Micro USB port on the RFD8500 is not intended for charging. The Micro USB port is for data transfer and firmware upgrading only. For daily charging, use the cable cup or charging cradles.

Before using the RFD8500 for the first time, charge the battery until the LED Power/Charging Indicator turns solid green (see [LED and Beeper Indicators on page 2-2](#) for charge status indications).

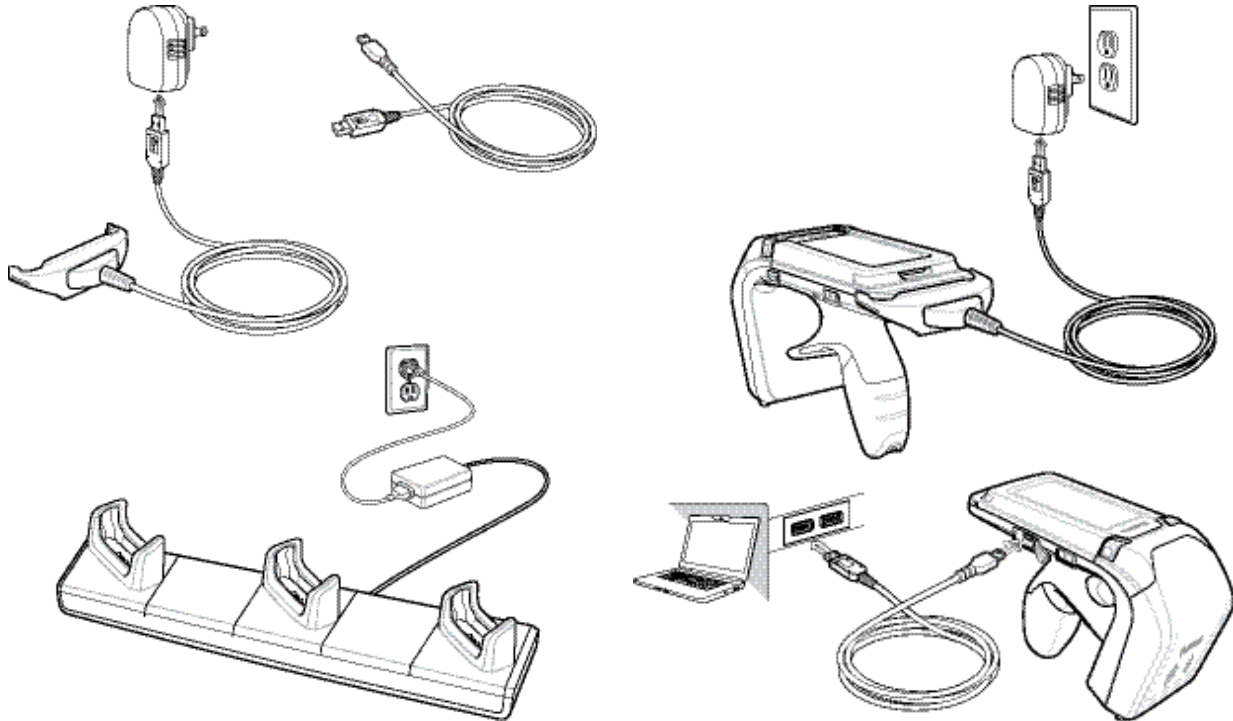

Figure 1-12 Charging Accessories

The Three Slot Charge Only cradle can be used to charge any combination of devices including the RFD8500, TC55, and a dual battery charger.

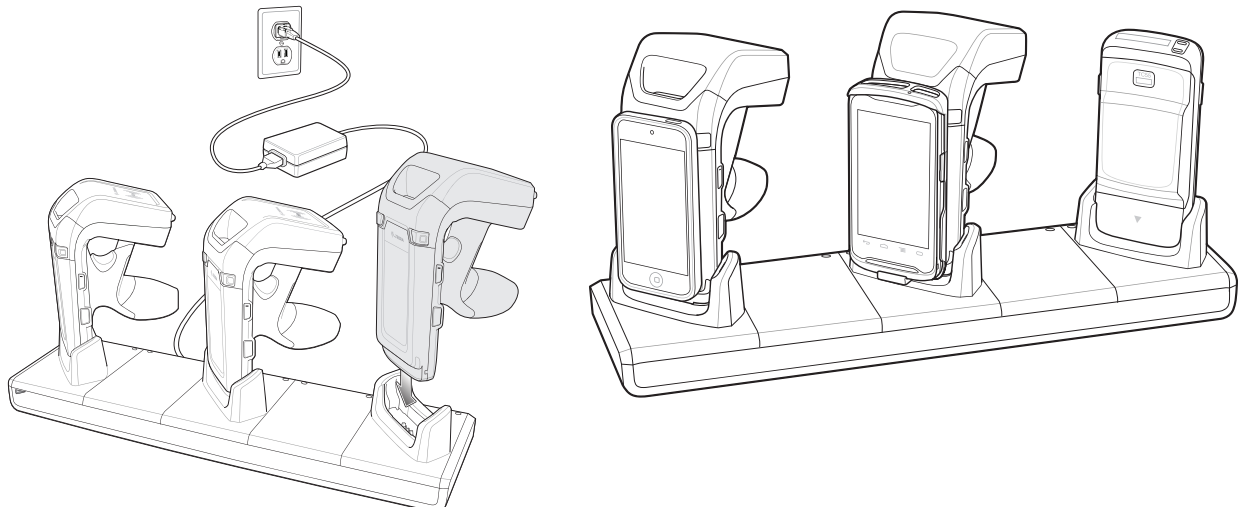

Figure 1-13 Charging Devices

Charging the Mobile Device Battery

Follow the instructions in the mobile device User Guide for charging the battery in the mobile device.

Charging Temperature

Charge batteries in temperatures from 0° C to 40° C (32° F to 104° F). The RFD8500 indicates when charging is disabled due to abnormal temperatures via its power LED.

✓ **NOTE** For safety reasons, ensure that the battery cover is properly installed.

When the battery is properly installed, the reader powers on and the power LED turns solid green.

Battery Management

Prior to checking the battery charge level, remove the RFD8500 from any AC power source (cradle or cable). To check the charge status of the main battery, the RFD8500 should be connected to the mobile computer over Bluetooth. When connected, run the appropriate Zebra RFID Mobile application and select *Settings > Battery Status*.

Battery status indicates that the battery is discharging and the battery level indicates the battery charge (as a percentage of fully charged). If using the partner application. Refer to the partner application documentation.

Low Battery Notification

When the reader has 20% battery remaining, the power LED becomes solid amber. No beeps sound.

When the battery State of Charge (SOC) is equal or less than 10%, the power LED is solid red and short beep sounds repeat ONLY when the device is NOT connected to a charger AND when the unit is active (not in low power mode, or off mode).

When the reader has 5% battery remaining, the reader sounds high, medium, low beeps before automatically powering off.

Battery Optimization

The RFD8500 supports intelligent performance and battery optimizations for your application needs. An API is available to enable this setting. Refer to the *RFD8500 RFID Developer Guide* (p/n MN002222AXX) for more information.

Also see iOS [Power Optimization on page 4-17](#).

Downloading Application Software

123RFID Mobile Application for Android

Requirements

- The recommended Android version on the mobile computer is Kit Kat version 4.4.x.
- Recommended Zebra Enterprise mobile computers: MC40, TC55, and TC70.

Installing the Software

Install the 123RFID Mobile application for Android (or partner application) on the mobile computer from the Zebra website. The procedure to install the software in an Android device depends on the Android version.

To install the software:

1. Connect the Android device to your computer. It should be connected as *MTP Device* and should show as a drive on your computer.
2. Go to *Device Settings > Security* and check *Unknown Sources* to allow installation of applications from unknown sources.
3. Copy the .apk file to the mobile device.
4. Go to *Settings > Security* and select *Unknown sources*.
5. Use *File Manager* to locate the .apk file in the folder to which you copied it in [Step 5.](#), and select it.
6. In the pop-up window, select the *Android App* installer.
7. The installation begins.
8. Before using the application, pair the Android device using the Android *BT Settings* (see [Pairing on page 2-5](#)). Pairing is initiated by the Android device.

Zebra RFID Mobile Application for iOS

Requirements

- iOS version is 8.0 or later is recommended.
- Recommended devices: iPod touch 5, iPhone 5, and iPhone 6.

Installing the Software

To install the software download the Zebra RFID Mobile application from Apple App Store.

Before using the application, pair the iOS device using iOS *BT Settings* (see [Pairing on page 2-5](#)). Pairing is initiated by the iOS device.

Chapter 2 USING the RFD8500

Introduction

This chapter includes information about LED and beeper indicators, Bluetooth Wireless Technology, and scanning.

Using the Features on the RFD8500

Using Buttons and the Scan Trigger

[Table 2-1](#) shows the functions of the RFD8500 buttons and scan trigger.

Table 2-1 *Trigger and Button Operations*

Option	Scan Trigger	Mode Button	Power Button	BT Button	Comments
Start/Stop RFID Tag Read	X				n/a
Start/Stop Bar Code Scan	X				n/a
Turn RFD8500 ON/OFF			X		Hold the Power button for three seconds to turn the RFD8500 OFF. Press the Power button again to turn the RFD8500 ON.
RFID Reader/ Bar Code Scanner Toggle		X			Press the Mode button to toggle scan trigger control between RFID tag reading and bar code scanning. Note: This function is only available on readers with an imager.
Enable Bluetooth				X	Hold the Bluetooth button for one second to turn on Bluetooth discovery. See Pairing on page 2-5 for more information.

Table 2-1 *Trigger and Button Operations (Continued)*

Option	Scan Trigger	Mode Button	Power Button	BT Button	Comments
Disconnect Bluetooth				X	When connected with a mobile device, hold the button for one second to disconnect from the current device and return it to discovery mode to connect with another device.
Turn Off Bluetooth				X	Hold the button for five seconds to turn off Bluetooth.
Soft Reset the RFD8500		X		X	Hold the Mode and Bluetooth buttons simultaneously for three seconds, then release to initiate the reset process.
Reset Device to Factory Defaults			X	X	Hold the Power and Bluetooth buttons simultaneously for five seconds, then release to initiate the factory reset process.

LED and Beeper Indicators

The LED and beeper indicators provide an indication of the operating statuses of the RFD8500. (See [RFD8500 Features on page 1-2](#) for the location of indicators.)

Table 2-2 *Status Indicators*

Condition	LED	Beeper
Power State Indicator (Power Button)		
Low battery (20%)	Solid amber	No beep
Lower battery (10%)	Solid red	Short beeps - repeated
Suspend	Solid red, then turns off	High/medium/low
Charging	Blinking amber	Short beep when charger is connected
Charged	Solid green	One beep
Charging error	Fast blink red	Three beeps
Power on	<ul style="list-style-type: none"> Green if battery charge > 20% Amber if battery charge between 10% - 20% Red if battery charge < 10% 	Low/medium/high beeps
Mode Indicator (Mode Button)		
RFID mode	Off	Short high button confirmation beep
Bar code mode	Solid green	Short high button confirmation beep

Table 2-2 Status Indicators (Continued)

Condition	LED	Beeper
Decode/RFID Read Indicator		
Good decode	Solid green	Short low beep
Transmit error	Solid amber for 2 seconds	Four beeps for RFID/four beeps for scanner read
Good RFID read	Solid green (for each read)	Short medium beep
RFID error	Amber	No beep
Other error message	Solid red	No beep
BT Indicator (BT Button)		
BT off	Off	No beep
BT on/not connected	Slow flash	No beep
BT discoverable	Medium flash	No beep
BT on/pairing in process	Fast flash	No beep
BT application connected	Solid blue	Short low/high beeps
BT out of range	Slow flash	Short high/low beeps

Bluetooth® Wireless Technology Connections

Bluetooth-equipped devices can communicate without wires, using frequency-hopping spread spectrum (FHSS) radio frequency (RF) to transmit and receive data in the 2.4 GHz Industry Scientific and Medical (ISM) band (802.15.1). Bluetooth wireless technology is specifically designed for short-range (10 meters/32.8 feet) communication and low power consumption.

Devices with Bluetooth capabilities can exchange information (e.g., files, appointments, and tasks) with other Bluetooth enabled devices such as printers, access points, and other mobile devices.

The RFD8500 can be paired with the following Android and Apple devices.

- Android Devices
 - Zebra MC40
 - Zebra TC55
 - Zebra TC70.
- Apple Devices
 - iPhone 5/6
 - iPod touch 5.

Adaptive Frequency Hopping

Adaptive Frequency Hopping (AFH) is a method of avoiding fixed frequency interference, and can be used with Bluetooth voice. All devices in the piconet (Bluetooth network) must be AFH-capable in order for AFH to work. There is no AFH when connecting and discovering devices. Avoid making Bluetooth connections and discoveries during critical 802.11b communications. AFH for Bluetooth consists of four main sections:

- Channel Classification - A method of detecting an interference on a channel-by-channel basis, or pre-defined channel mask.
- Link Management - Coordinates and distributes the AFH information to the rest of the Bluetooth network.
- Hop Sequence Modification - Avoids interference by selectively reducing the number of hopping channels.
- Channel Maintenance - A method for periodically re-evaluating the channels.

When AFH is enabled, the Bluetooth radio “hops around” (instead of through) the 802.11b high-rate channels. AFH coexistence allows Enterprise devices to operate in any infrastructure.

The Bluetooth radio in this device operates as a Class 2 device power class. The maximum output power is 2.5 mW and the expected range is 10 meters (32.8 ft.). A definition of ranges based on power class is difficult to obtain due to power and device differences, and whether one measures open space or closed office space.



NOTE It is not recommended to perform Bluetooth wireless technology inquiry when high rate 802.11b operation is required.

Security

The current Bluetooth specification defines security at the link level. Application-level security is also available via a ZETI interface password. This allows application developers to define security mechanisms tailored to their specific need. Link-level security occurs between devices, not users, while application-level security can be enabled globally. The Bluetooth specification defines security algorithms and procedures required to authenticate devices, and if needed, encrypt the data flowing on the link between the devices. Device authentication is a mandatory feature of Bluetooth while link encryption is optional. The RFD8500 Bluetooth interface uses authentication and security by default, and is compatible with devices supporting Bluetooth v2.1 and later.

RFD8500 uses the 'just works' methods defined under the Secure Simple Pairing (SSP) framework. Thus, no personal identification number (PIN) is required to pair.

Recommendations are:

- Perform pairing in a secure environment
- Implement application-level security.

The RFD8500 supports the following Bluetooth services:

- Bluetooth v2.1 devices and later.

Pairing

Pairing with the RFD8500 is completed from the Android or iOS Platform via Bluetooth *Settings* on the mobile device.

Prior to pairing the RFD8500 with another device ensure the RFD8500 is charged.



IMPORTANT For successful pairing of the RFD8500 to an Android or iOS Device, the yellow trigger on RFD8500 must be pressed when the RFD8500 displays in the list of available discoverable devices, and the RFD8500 Bluetooth LED starts flashing fast. See the step-by-step instructions for pairing.

Conventional Bluetooth Pairing Method

Pairing with an Android Device

To pair with an Android device such as the TC55:

1. Power on the TC55.
2. Touch the *Settings* icon on the mobile device.
3. Turn Bluetooth on.
4. Touch *Search for Devices* to display the available discoverable devices.
5. Turn the RFD8500 on and ensure Bluetooth is enabled. If not, press the **Bluetooth** button on the RFD8500 for one second to make it discoverable. When discoverable, the Bluetooth LED flashes blue.

✓ **NOTE** The RFD8500 is discoverable over Bluetooth for 40 seconds after start up. After that time Bluetooth suspends and is no longer discoverable. To restart discovery, press the **Bluetooth** button for one second.

6. When the RFD8500 displays in the list of available discoverable devices, tap the RFD8500 device in the list **and press the RFD8500 trigger** to pair when the Bluetooth LED starts flashing fast. A beep sounds when pairing completes successfully.

✓ **NOTE** Ensure you choose the correct RFD8500 serial number from the list of discoverable devices.

7. Exit the *Device Settings* screen and run the application.
8. From the application, select *Settings > Readers List* and confirm that the RFD8500 serial number you paired with is displayed. Select it in the list of Available Readers. This connects the RFD8500 to the mobile device.

✓ **NOTE** Refer to the *TC55 User Guide*, p/n MN000015AXX, for detailed information about the device.

Pairing with an iOS Device

To pair with an iOS device:

1. Power on the iOS device.
2. Touch the *Settings* icon on the device.
3. Touch *Bluetooth* to display the *Bluetooth Settings* screen and ensure it is on.
4. Turn the RFD8500 on and ensure Bluetooth is enabled. If not, press the **Bluetooth** button on the RFD8500 for one second to make it discoverable. When discoverable, the Bluetooth LED flashes blue.

✓ **NOTE** The RFD8500 is discoverable over Bluetooth for 40 seconds after start up. After that time Bluetooth suspends and is no longer discoverable. To restart discovery, press the **Bluetooth** button for one second.

5. When the RFD8500 displays in the list of available discoverable devices, tap the RFD8500 device in the list **and press the RFD8500 trigger** to pair when the Bluetooth LED starts flashing fast. A beep sounds when pairing completes successfully.

✓ **NOTE** Ensure you choose the correct RFD8500 serial number from the list of discoverable devices.

6. Exit the *Device Settings* screen and run the application.
7. From the application, select *Settings > Readers List* and confirm that the RFD8500 serial number you paired with is displayed. Select it in the list of Available Readers. This connects the RFD8500 to the mobile device.

✓ **NOTE** Refer to the *iOS User Guide* for detailed information about the device.

Pairing with a Windows Mobile Device

To pair with a Windows 10 mobile device:

1. Power on the Windows 10 device.
2. Touch the **Settings** icon on the device.
3. Touch the **Devices** icon in settings.
4. Touch the **Bluetooth** icon in Devices.
5. Turn Bluetooth on.
6. The phone/PC automatically searches and displays the available discoverable devices on the **Bluetooth** screen.
7. Turn the RFD8500 on and ensure Bluetooth is enabled. If not, press the **Bluetooth** button on the RFD8500 for one second to make it discoverable. When discoverable, the Bluetooth LED flashes blue.
8. When the RFD8500 displays in the list of available discoverable devices, tap the RFD8500 device in the list and **press the RFD8500 trigger** to pair when the Bluetooth LED starts flashing fast. A beep sounds when pairing completes successfully.
9. Exit the **Device Settings** screen and run the application.

10. From the application, select **Settings > Readers List** and confirm that the RFD8500 serial number you paired with is displayed. Select it in the list of Available Readers. This connects the RFD8500 to the mobile device.



IMPORTANT For successful pairing of the RFD8500 to an Android, iOS device or Windows 10, the yellow trigger on the RFD8500 must be pressed when the RFD8500 displays in the list of available discoverable devices, and the RFD8500 Bluetooth LED starts flashing fast. See the step-by-step instructions for pairing.



NOTE The RFD8500 is discoverable over Bluetooth for 40 seconds after start up. After that time Bluetooth suspends and is no longer discoverable. To restart discovery, press the **Bluetooth** button for one second.

Ensure you choose the correct RFD8500 serial number from the list of discoverable devices.

Using the Locate Device Bar Code

The Locate Device bar code appears on the RFD8500 under the antenna compartment. When you pair several RFD8500 devices with your mobile device via Bluetooth, use the serial number represented by the Locate Device bar code to identify a specific paired RFD8500. The bar code can also be used for pairing. Refer to the *RFD8500 RFID Developer Guide* (p/n MN002222AXX) for details.

Reading Tags

To read tags, see [Chapter 3, 123RFID MOBILE APPLICATION for ANDROID](#) and [Chapter 4, ZEBRA RFID MOBILE APPLICATION for iOS](#).

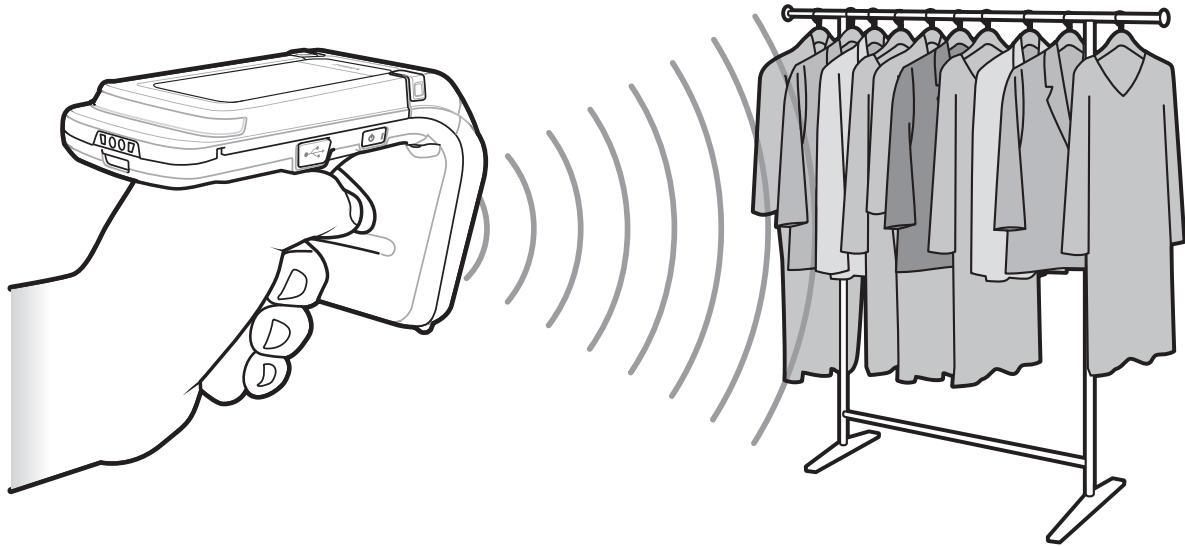

Figure 2-1 Reading Tags

Scanning Bar Codes

To scan bar codes, see the information in [Chapter 6, ZEBRA SCANNER CONTROL APPLICATION for ANDROID](#) and [Chapter 7, ZEBRA SCANNER CONTROL APPLICATION for iOS](#).

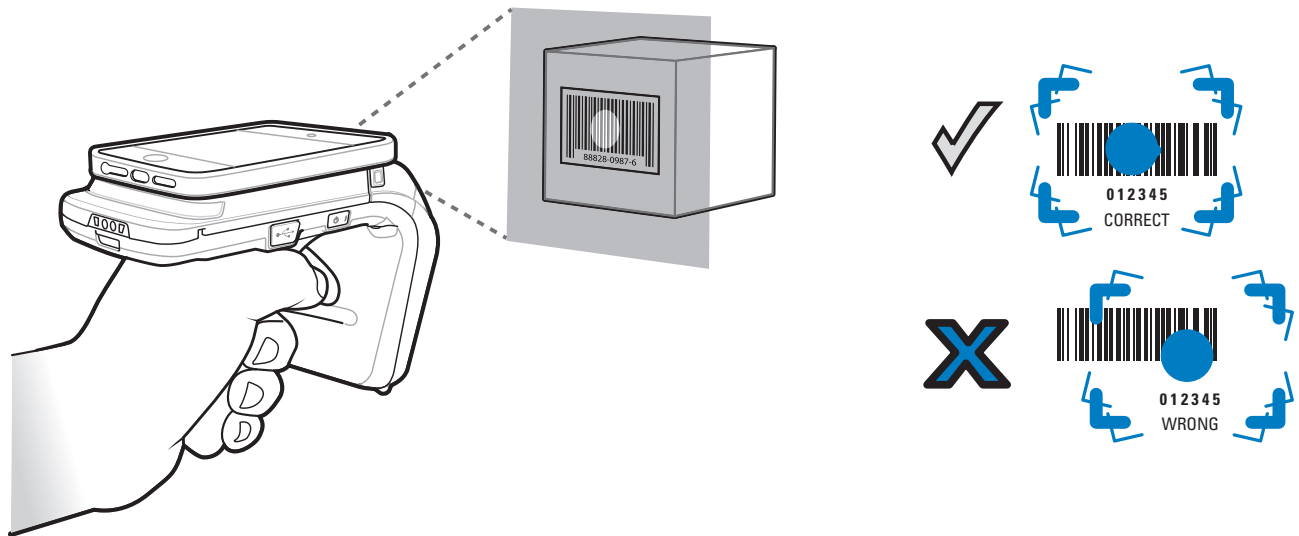

Figure 2-2 Scanning Bar Codes

Transferring Data

Transferring Data in Batch Mode

When the RFD8500 is configured to batch data it is capable of scanning bar codes and reading RFID tag data without a Bluetooth connection in place. It is recommended to stop scanning and reading functions before transferring the data via the Bluetooth interface. The **Delay before data transmission in Batch Mode** parameter in the 123Scan RFD8500 plug-in controls whether or not a delay should be enforced before transferring the data in HID mode. By default, this parameter is zero. RFID data is not transferred automatically in ZETI mode. Instead it has be requested by the application using the `gettags` ZETI command. For more information, refer to the 123RFID Mobile App for Android or iOS source code and the developer guides.

Transferring Data via Bluetooth

By default, the RFD8500 operates in auto Batch Mode. In this mode the RFD8500 pushes bar code, or RFID data after a scan or read request is issued by the connected application. If the Bluetooth link quality degrades and breaks, the RFD8500 (in auto Batch Mode) is capable of moving automatically to Batch Mode while simultaneously allowing current scanning, or RFID operations to be unaffected. If the Bluetooth connection is regained after the RFD8500 entered Batch Mode, see [Transferring Data in Batch Mode](#) above to offload the data acquired while the unit was operating in Batch Mode.

Transferring Data via USB

By default, the RFD8500 is not configured to transfer data via the USB port. 123Scan can be used to configure USB Communication Device Class (CDC) or USB Human Interface Device class (HID) modes.

- USB CDC mode supports RFID data via the ZETI protocol.
- USB HID mode supports both RFID and bar code.

Use the Cable connection page in 123Scan to choose between two options.

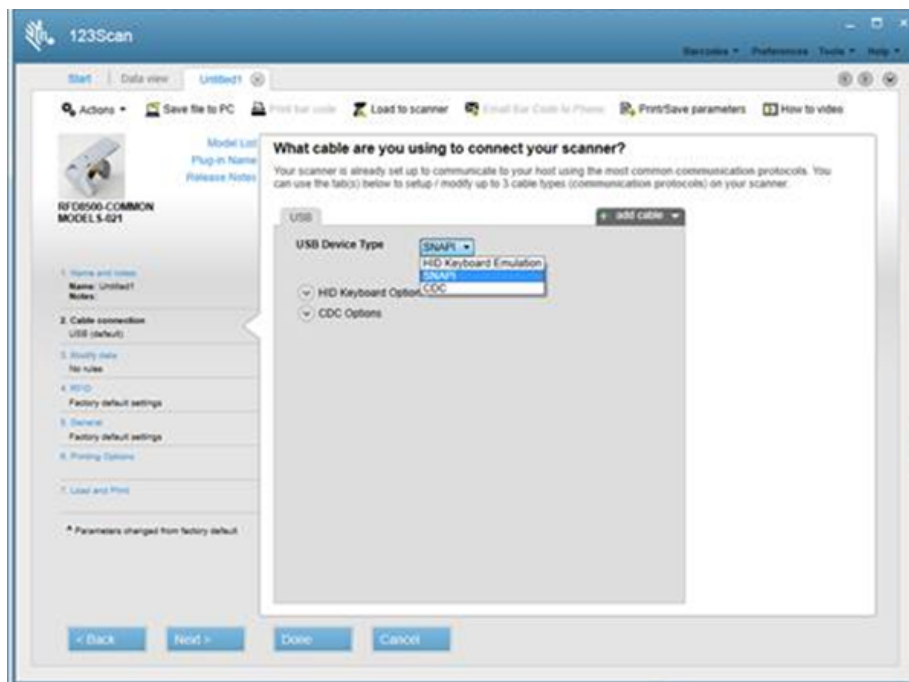

Figure 2-3 123Scan USB Connection Screen

USB SNAPI mode is the default USB configuration and it is used primarily to manage the RFD8500 (configuration and firmware updates).

The USB CDC mode requires the Zebra CDC driver for Windows which can be obtained from the Barcode Scanner SDK Driver Utilities site at:

<https://www.zebra.com/us/en/products/software/scanning-systems/scanner-drivers-and-utilities.html>

The driver can be found by choosing the Virtual Com Port link.

Chapter 3 123RFID MOBILE APPLICATION for ANDROID

The upgraded Zebra RFID Mobile Application is now called the 123RFID Mobile Application. For detailed information about this app refer to the 123RFID Mobile Application User Guide, p/n MN-003765-xx. This guide describes the app for Android and demonstrates the device's capability and tag operation functionality.

The guide is available at: zebra.com/support.

Chapter 4 ZEBRA RFID MOBILE APPLICATION for iOS

Introduction

This chapter describes the *Zebra RFID Mobile Application for iOS* that can be used with the RFD8500.

There are five applications:

- 123RFID Mobile Application for Android
- Zebra RFID Mobile Application for iOS
- Zebra RFID Mobile Application for Windows
- Zebra Scanner Control Application for iOS
- Zebra Scanner Control Application for Android.

When using a partner application, the features/functionality might vary.

Using the Zebra RFID Mobile Application for iOS

This application runs on iOS mobile devices and demonstrates RFD8500 capability and tag operation functionality.

The application allows the user to navigate to all screens (except to some screens within the *Settings* page), whether or not the device is connected to the RFD8500 reader.

The *Settings* screens display the application defaults when there is no connection to the reader. When not connected, an attempt to perform any operation (*Rapid Read, Inventory, Locate tag, Access Operations, Save Configuration, Battery Status*) displays *No Active Connection with Reader*.

To use this application for RFID operations:

1. Ensure the *Zebra RFID Mobile Application for iOS* is installed on the iOS mobile device.
2. Ensure the RFD8500 is in RFID mode.
3. Pair the mobile device with the RFD8500 over Bluetooth (see [Pairing on page 2-5](#)).
4. Launch the *Zebra RFID Mobile Application for iOS* on the mobile device.

5. Select *Settings > Readers List* and select the RFD8500 device to connect.
6. Return to the *Home* screen and select *Settings > Antenna*. *Power Level* is set to 27.0 dBm by default. Japan units are set to a different default power level depending on the SKU type.
7. Before using the device set the region in which the device is operating. To set the region, open the application and select *Settings > Regulatory* (see [Regulatory on page 4-15](#)).

Pairing with an iOS Device

See [Pairing with an iOS Device on page 2-6](#) for the pairing process. The iOS process is similar to the Android pairing process.

After the application deploys, tap the **About** button to display the *About* screen. The *About* screen displays version information.

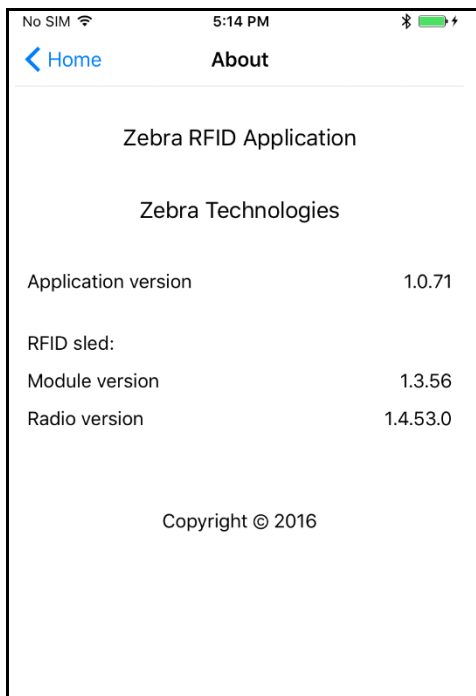

Figure 4-1 *Version Screen*

Pairing using S/N Bar Code

The RFD8500 can be paired with a host that can scan the bar code printed at the bottom of the RFD8500 antenna.

An Android demo application, sample code, and a white paper (see [Related Documents on page ix](#)) describing this Bluetooth pairing process can be obtained by sending a request to Zebra support.

The procedure generally entails the following, in this order:

1. Run the Android demo application.
2. Press the RFD8500 **Bluetooth** button to start Bluetooth discovery mode.
3. Scan the RFD8500 S/N bar code at the bottom of the RFD8500 antenna.
4. Press the RFD8500 trigger to complete the pairing process.

Home Screen

To access the *Zebra RFID Mobile Application for iOS*, touch the application icon () on the mobile device to display the *Home* screen. Touch any icon to access its screen.

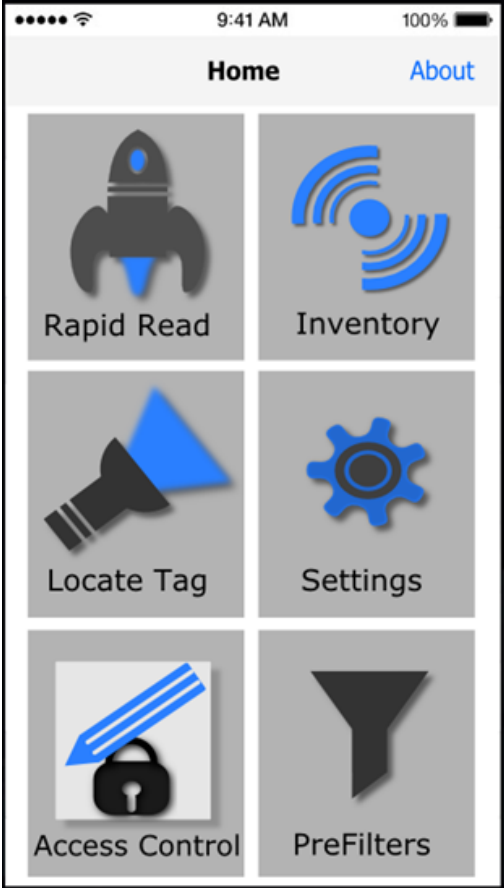

Figure 4-2 Home Screen

Rapid Read

Touch *Rapid Read* from the *Home* screen.

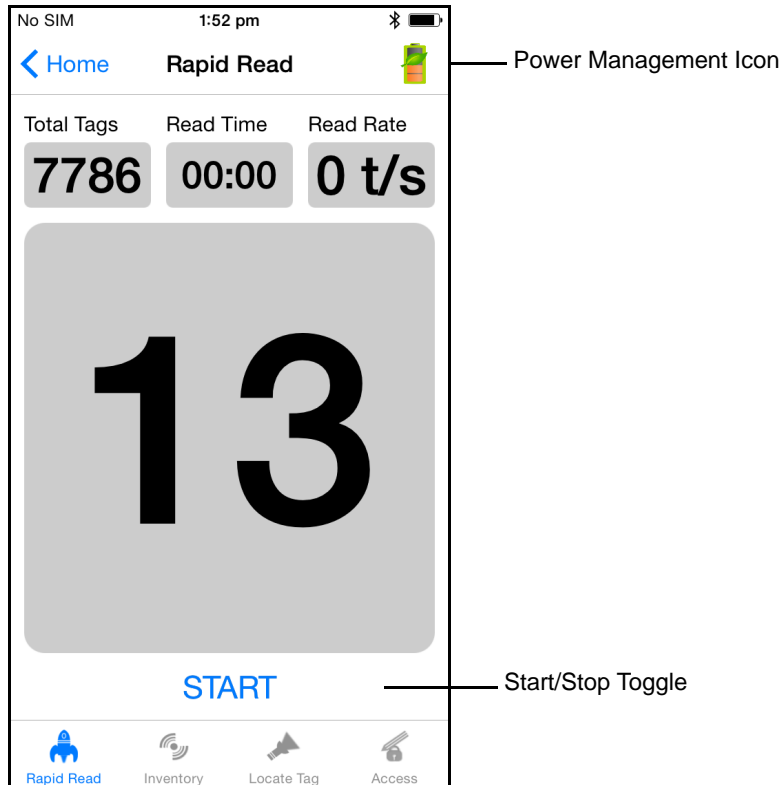

Figure 4-3 *Rapid Read* Screen

The *Rapid Read* and *Inventory* screens display the following data (see [Inventory](#) on page 4-5).

- Dynamic Power Optimization (DPO) status - When enabled, battery life is enhanced when performing inventory operations.
- Total tag count
- Read time (mm:ss)
- Tag read rate (tags/sec)
- Unique tag count (displays in the center of screen).

Rapid Read and *Inventory* screens are two different views of the inventory operation on the reader. The start/stop functionality can be used interchangeably on both screens. For example, when the user starts the operation on the *Rapid Read* screen and navigates to the *Inventory* screen, the button available on the *Inventory* screen is **STOP**. The same is true when the operation starts on the *Inventory* screen. During the rapid read process the user can navigate to the *Inventory* screen to view tag details along with tag counts for each tag. The statistics displayed are maintained on the *Rapid Read* and *Inventory* screens regardless of the screen used to start the process.

Touch **START** to start the rapid read inventory operation. Touch **STOP** to stop.



NOTE The scan trigger on the RFD8500 can also start and stop the inventory operation. The reader must be in RFID mode. Press the trigger to start, and press again to stop.

Moving to another screen does not halt the operation. However, attempting to make changes or perform another operation while rapid read is in process results in an error.

Inventory

Touch *Inventory* from the *Home* or *Menu* screen.

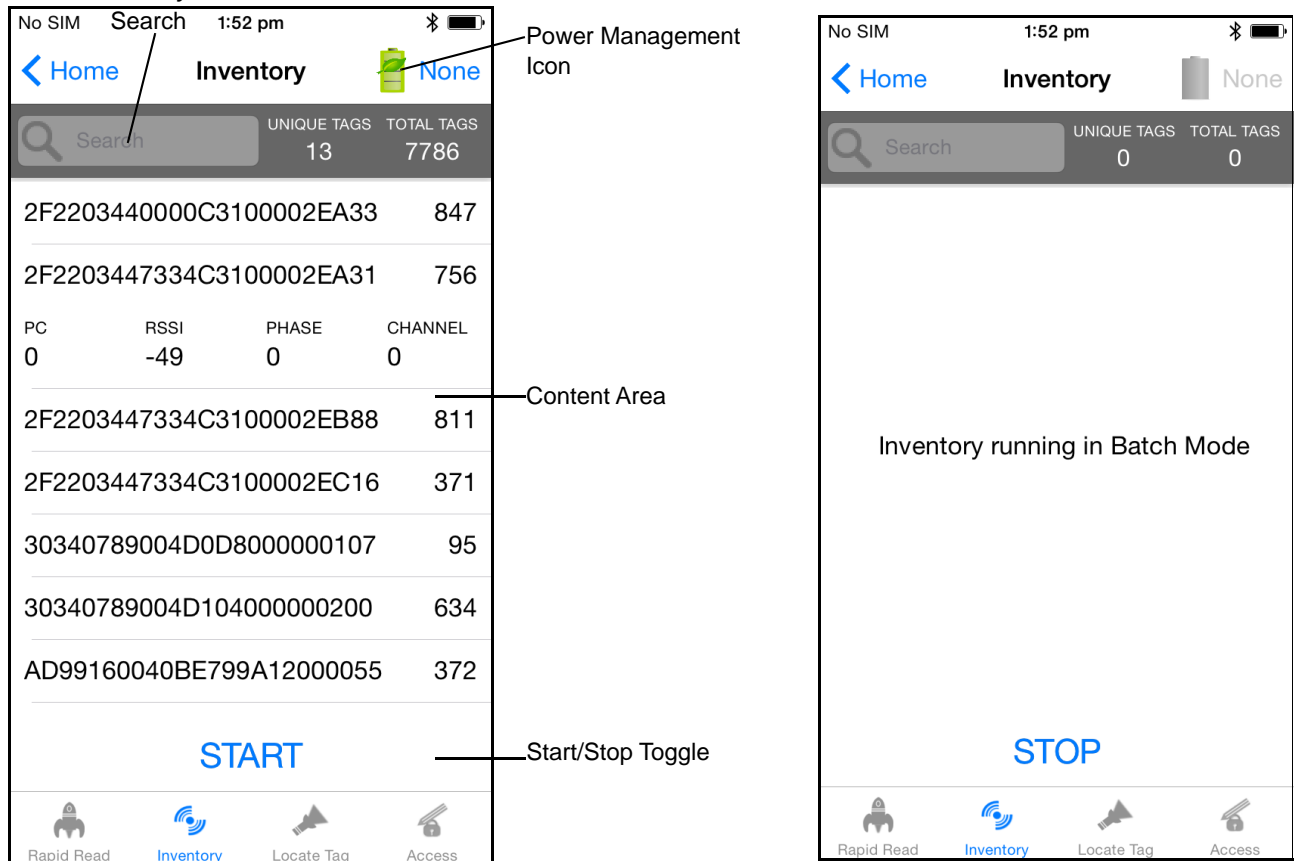

Figure 4-4 *Inventory Screen*

Tag reading can be started and stopped on this screen as well as on the *Rapid Read* screen (see [Rapid Read on page 4-4](#)). When the process starts, tag information displays on the screen.

Touch **START** to start the rapid read inventory operation. The button changes to **STOP**. Touch it to stop the read inventory operation.

✓ **NOTE** The scan trigger on the RFD8500 can also start and stop the inventory operation. The reader must be in RFID mode. Press the trigger to start, and press again to stop.

The tag ID selected displays on *Locate Tag* screen when navigating to that screen (see [Locate Tag on page 4-7](#)).

Inventory Screen Features

Table 4-1 Features on the Inventory Screen

Item	Description										
Action Bar											
Tags	<p>Touch the Memory Bank section and select one of the following memory bank options from the drop-down menu:</p> <ul style="list-style-type: none"> • None - Defaults to EPC. • User - Type of tag in the Memory Bank • Reserved - Type of tag in the Memory Bank • TID - Type of tag in the Memory Bank • EPC - Type of tag in the Memory Bank <p>When the next inventory operation starts, the details from the selected memory bank displays. This menu is inactive if there is an ongoing operation on the connected reader.</p> <p>Default Display: None</p>										
Search	Touch the <i>Search</i> icon and enter a tag ID. Tags that match the entry display in the content area.										
Power Management icon	Indicates whether Dynamic Power Optimization is enabled. When enabled, battery life is enhanced when performing inventory operations.										
Content Area (select a tag)	Touching a <i>Tag ID</i> highlights the tag. The highlighted <i>Tag ID</i> is populated on the <i>Tag Location</i> text area. Touch START to start searching for the tag. See Locate Tag on page 4-7 for more details. From this screen return to the <i>Menu</i> or go to the <i>Home</i> screen and select <i>Locate Tag</i> .										
Content Area (select a tag)	<p>The tags displayed in this area are based on the option selected from the memory bank. Touch the tag ID to expand details about the tag. Touch the tag ID again to collapse details.</p> <p>Example Default Tag Display:</p> <table border="0" data-bbox="483 1335 1127 1402"> <thead> <tr> <th style="text-align: left;">Tag ID</th> <th style="text-align: right;">Tag Count</th> </tr> </thead> <tbody> <tr> <td>AD99 1540419072596540040</td> <td style="text-align: right;">4</td> </tr> </tbody> </table> <p>Example Expanded Tag Display:</p> <p>Note: Expanded tag detail can only display when the inventory operation is stopped. Memory bank data is shown only when inventory is complete.</p> <table border="0" data-bbox="483 1520 1127 1621"> <thead> <tr> <th style="text-align: left;">Tag ID</th> <th style="text-align: right;">Tag Count</th> </tr> </thead> <tbody> <tr> <td>AD99 1540419072596540040</td> <td style="text-align: right;">4</td> </tr> <tr> <td>EPC MEMORY</td> <td style="text-align: right;">3000</td> </tr> </tbody> </table> <p>RSSI -50 Phase 1800 USER 1122334455667788AABBCCDDEEFF 1122334455667788AABBCCDDEEFF 1122334455667788AABBCCDDEEFF</p>	Tag ID	Tag Count	AD99 1540419072596540040	4	Tag ID	Tag Count	AD99 1540419072596540040	4	EPC MEMORY	3000
Tag ID	Tag Count										
AD99 1540419072596540040	4										
Tag ID	Tag Count										
AD99 1540419072596540040	4										
EPC MEMORY	3000										

Locate Tag

Touch *Locate Tag* from the *Home* or *Menu* screen.

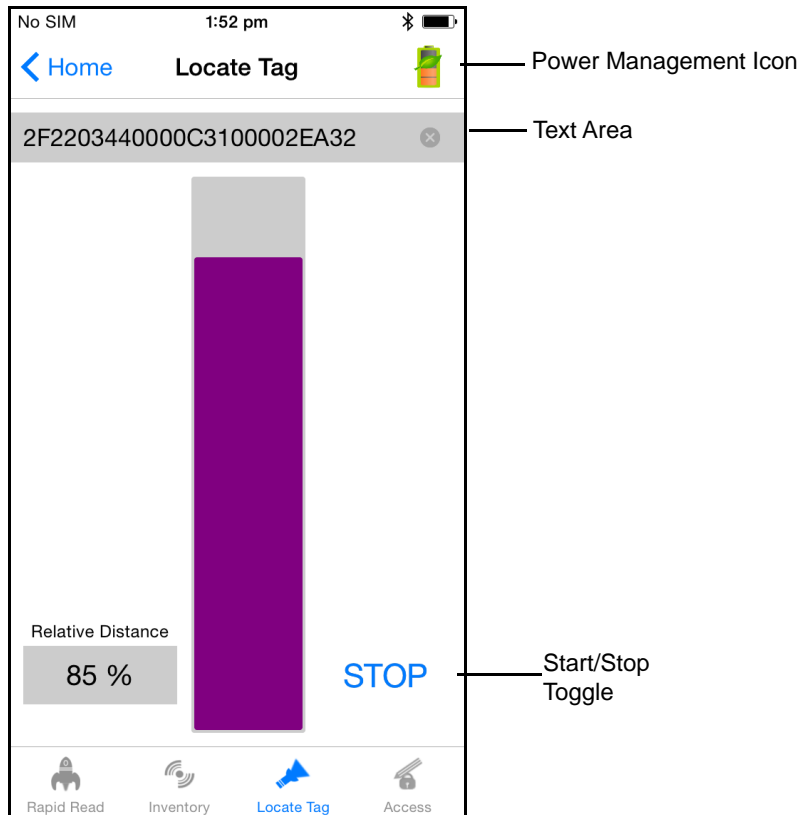

Figure 4-5 *Locate Tag* Screen

On this screen, enter the *Tag ID* in the text area or select a from the *Inventory* screen to pre-populate the *Tag ID* to search.

Touch **START** to start the locate tag operation. Touch **STOP** to stop. The RFD8500 trigger can also be used to start and stop the operation.

✓ **NOTE** The scan trigger on the RFD8500 can also start and stop the inventory operation. The reader must be in RFID mode. Press the trigger to start, and press again to stop.

The color bar on the display shows the relative distance of the tag.

When the locate tag operation starts, moving to another screen does not stop the operation until Stop is pressed.

The *Power Management* icon indicates whether Dynamic Power Optimization is enabled. When enabled, battery life is enhanced when performing inventory operations.

Settings

Touch *Settings* from the *Home* screen.

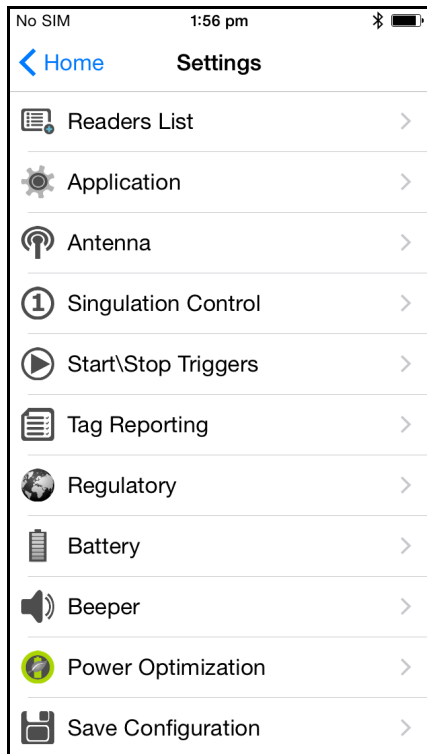

Figure 4-6 *Settings Screen*

Table 4-2 *Settings Screen Options*

Settings Option	Description	Page
Readers List	Displays all previous and new RFD8500 readers with which the mobile device paired.	4-9
Application	Displays reader connection, notification, and Data Export Settings.	4-10
Antenna	Displays antenna power lever and link profile.	4-11
Singulation Control	Displays <i>Session</i> , <i>Tag Population</i> , <i>Inventory State</i> and <i>SL Flag</i> .	4-12
Start\Stop Triggers	Allows START and STOP button control.	4-13
Tag Reporting	Allows the user to control the optional fields reported as part of the Tag Data.	4-14
Regulatory	Allows region and channel selections.	4-15
Battery	Displays the RFD8500 battery status.	4-16

Table 4-2 *Settings Screen Options (Continued)*

Settings Option	Description	Page
Beeper	Use to turn the beeper on/off, and set volume.	4-18
Power Optimization	Turns Dynamic Power Optimization on and off.	4-17
Save Configuration	Allows the user to save all settings: <i>Antenna, Singulation, Tag Reporting, START/STOP trigger, Beeper Volume, and Regulatory.</i> Note: The settings are also automatically saved when the user changes anything.	4-19

Readers List

From the *Settings* screen, touch *Readers List*.

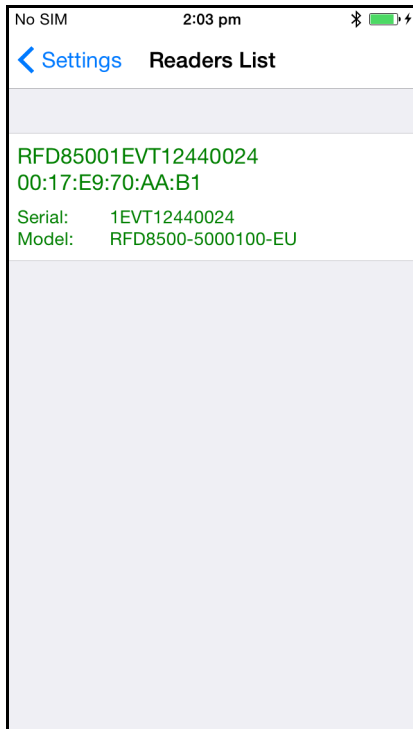
**Figure 4-7** *Settings - Readers List Screen*

This screen displays all available Bluetooth paired RFD8500 readers. The list includes the readers' serial and model numbers.

Touch a reader name from the list to establish a session with the selected reader; touch again to terminate the session. Touching a second reader in the list disconnects the currently connected reader and attempts to establish a connection to the newly selected reader.

Application

From the *Settings* screen, touch *Application*.

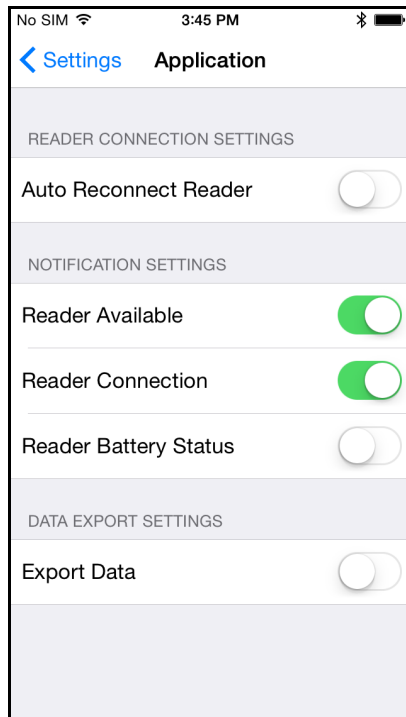

Figure 4-8 *Settings - Application Screen*

The default *Application* setting is *Reader Battery Status*.

The application always detects readers that were paired over Bluetooth.

Data Export Settings enable and disable exporting RFID data captured in the *Rapid Red* and *Inventory* screens. Enabling *Export Data* creates a file in the iOS device which can be exported using iTunes.

✓ **NOTE** Data Export Settings only apply to iOS devices.

To export this file:

1. Connect the iOS device via USB or WiFi to iTunes (running on either a MAC or PC).
2. Select *Application*.
3. Select the Zebra RFID Mobile App.
4. Select the file to export from the iOS device to the MAC/PC.

Antenna

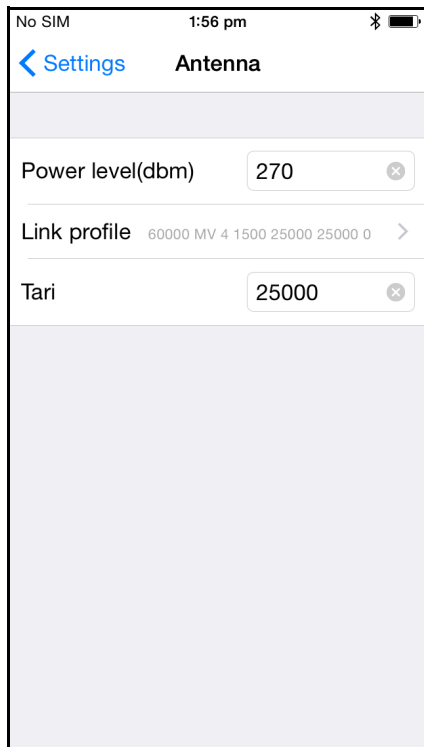

Figure 4-9 Settings - Antenna Screen

This screen displays:

- *Power Level* displays the current selection and includes a drop-down list of available power levels (as reported by RFD8500). 27.0 dBm is the default setting, and it is shown as 270 because the value used is in units of tens of dBm. Japan units are set to a different default power level depending on the SKU type.
- *Link Profile* displays the current selection and includes a drop-down list of available link profiles supported by the RFD8500.

Link Profile display format is as follows: Return link bit data rate in bis per second (e.g., 60000 -> 60 Kbs); Miller Value (e.g., MV_4 -> Miller 4); modulation type (PR ASK is the only one supported); PIE value has no units and is either 1.5 or 2 (e.g., 1.5 -> 1500 and 2 -> 2000); minimum Tari value in thousands of micro seconds (e.g., 6250 -> 6.25 microseconds); maximum Tari value in thousands of micro seconds; Tari step value in thousands of micro seconds. If the step value is zero, then Tari is fixed for this link profile. If the step size is non zero, then the default Tari value is the minimum value.

- Tari indicates the supported Tari for the chosen link profile.

The *Power Level* and *Link Profile* are blank when there is no connection to the reader.

Singulation Control

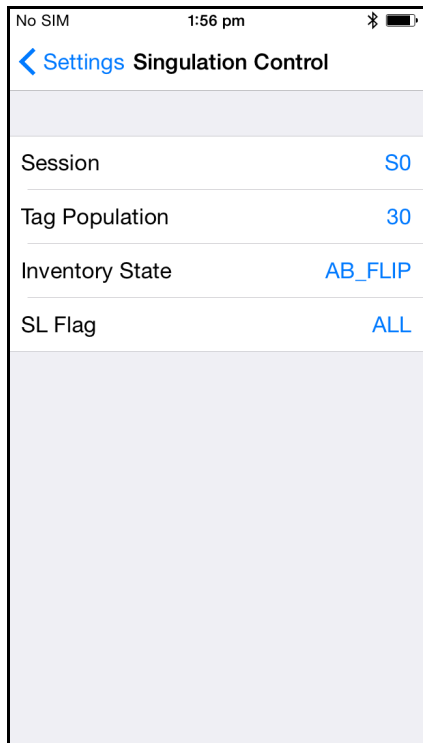

Figure 4-10 Settings - Singulation Control Screen

Use this screen to view/configure the singulation control settings for each antenna.

- *Session* options. The drop-down list includes the available options (S0, S1, S2, S3).
- *Tag Population*. A numeric value of the estimated number of tags in the Field of View (FOV). Values shown are 30,100,200,300,400,500,600.
- *Inventory State* options. State A & State B, AB FLIP
- SL flag options: ALL, DEASSERTED, ASSERTED

All values can be selected from the drop-down lists.

Start\Stop Triggers

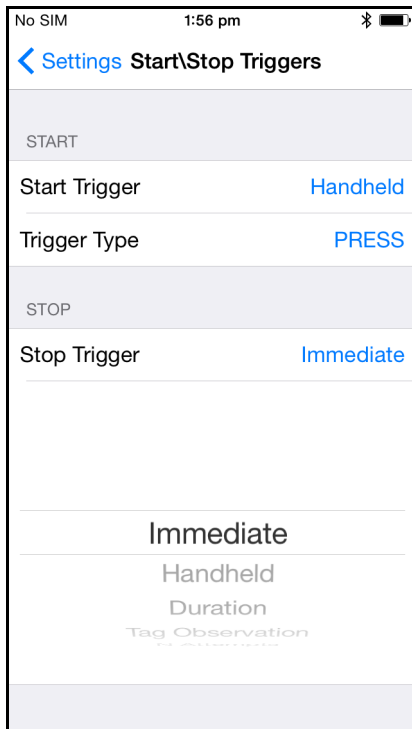

Figure 4-11 Settings - Start/Stop Triggers Screen

If the user does not enter all the required details for saving triggers to the reader, the application does not save the trigger settings to the reader.

- Start Trigger - the user can select one of the start trigger types below.
 - Immediate.
 - Hand-held - User should select either the *Trigger Pressed* or *Trigger Released* check box. If the start trigger type is hand-held trigger (pressed or released) the application sets the repeat for the operation to ensure the use case if repeated operations can be demonstrated.
 - Periodic - User should enter the period of time in milliseconds.
- Trigger Type - the user can select either *PRESS* or *RELEASE*, available when the *Start Trigger* is configured for *Handheld*.
- Stop Trigger - the user can select one of the stop trigger types below.
 - Immediate.
 - Hand-held - User should select either the *Trigger Pressed* or *Trigger Released* check box along with *Timeout* in milliseconds.
 - Duration - User should enter duration in milliseconds.
 - Tag Observation - User should enter the tag count along with timeout in milliseconds.
 - N Attempts - User should enter the number of attempts along with timeout in milliseconds.

Tag Reporting

These selections drive what the user sees on the *Inventory* screen.

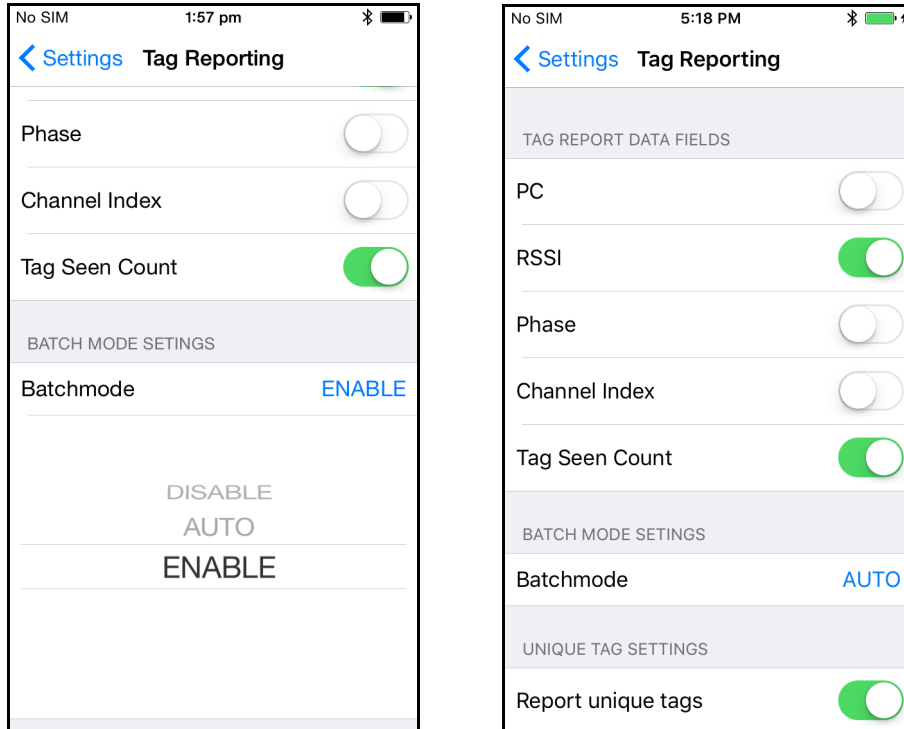

Figure 4-12 Settings - Tag Reporting Screens

Regulatory

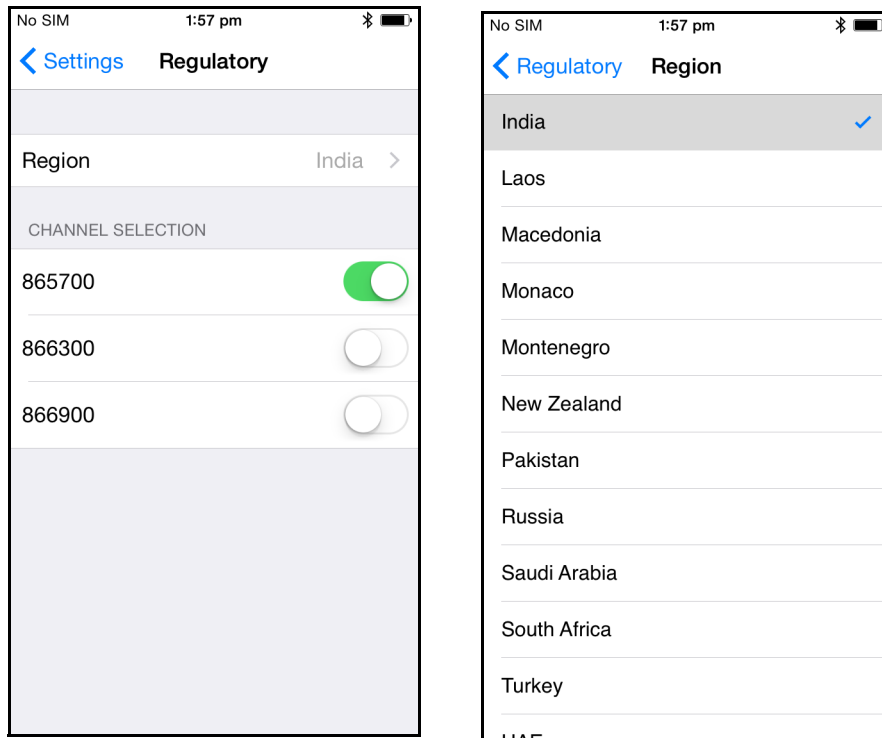

Figure 4-13 Settings - Regulatory and Regions Screens

The region drop-down displays the current region to which the device is set. Choose the correct region before using the device.

- Channel selection is allowed only for the regions that allow channel setting.
- Supported regions are reported by the RFD8500.
- If the region is not configured on the RFD8500 the *Regulatory* screen is the first screen displayed after connecting to the RFD8500.

Battery

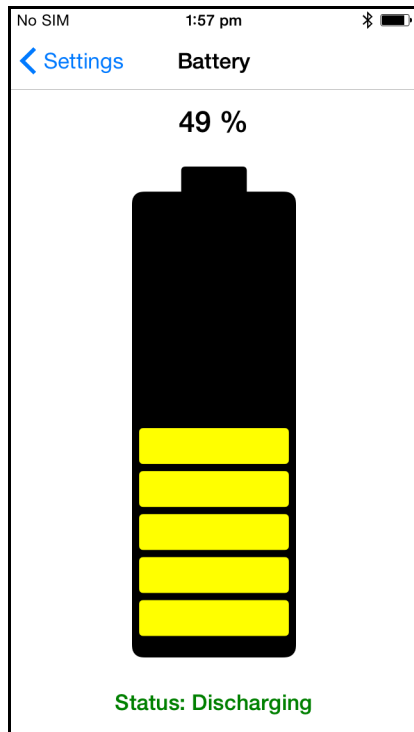

Figure 4-14 Settings - Battery Screen

This screen displays the status of the battery in the RFD8500.

- Level is 100% (in green): *Status: Battery is fully charged.*
- Charging (in green): *Status: Charging.*
- Discharging (in green): *Status: Discharging.*
- Critical (in red): *Status: Battery Level is Critical.*
- Low (in red): *Status: Battery Level Low.*
- Reader is not connected (in grey): *No Active Connection.*

Power Optimization

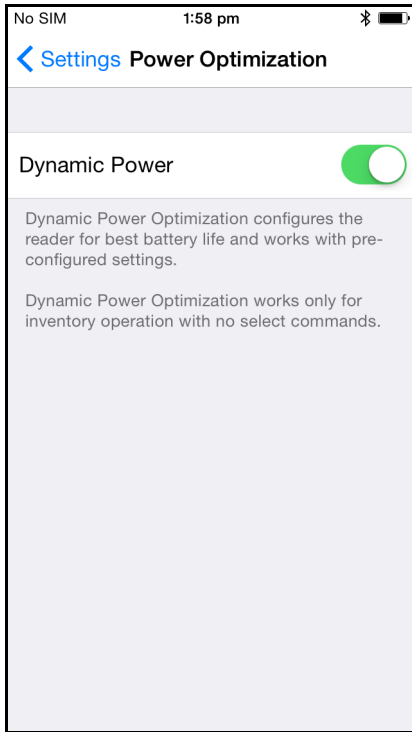

Figure 4-15 Settings - Power Optimization Screen

This screen provides an option to enable dynamic power optimization (DPO) in the reader. Enabling DPO enhances battery life when performing inventory operations.

✓ **NOTE** DPO is enabled by default. With DPO enabled, access operations and filters/singulation setting changes do not take effect.

If Dynamic Power is on, a green battery icon appears in the title bar of the application. Clicking on this opens the *Battery Status* screen.

Beeper

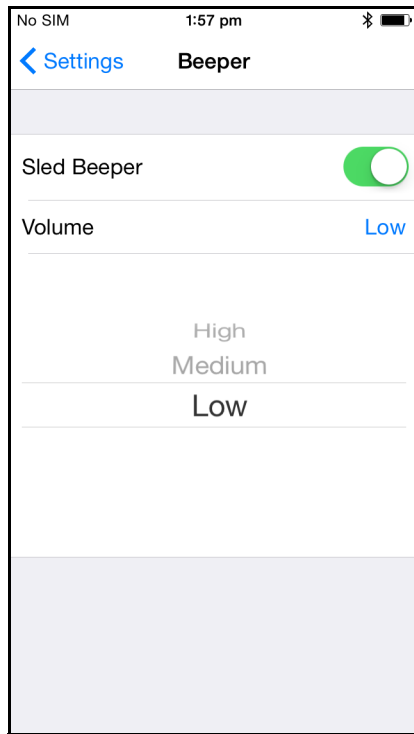

Figure 4-16 Settings - Beeper Screen

This screen displays the current beeper settings. The user can turn the beeper off (by unchecking the *Sled Beeper* check box), or set the volume to *High*, *Medium* or *Low*.

Save Configuration

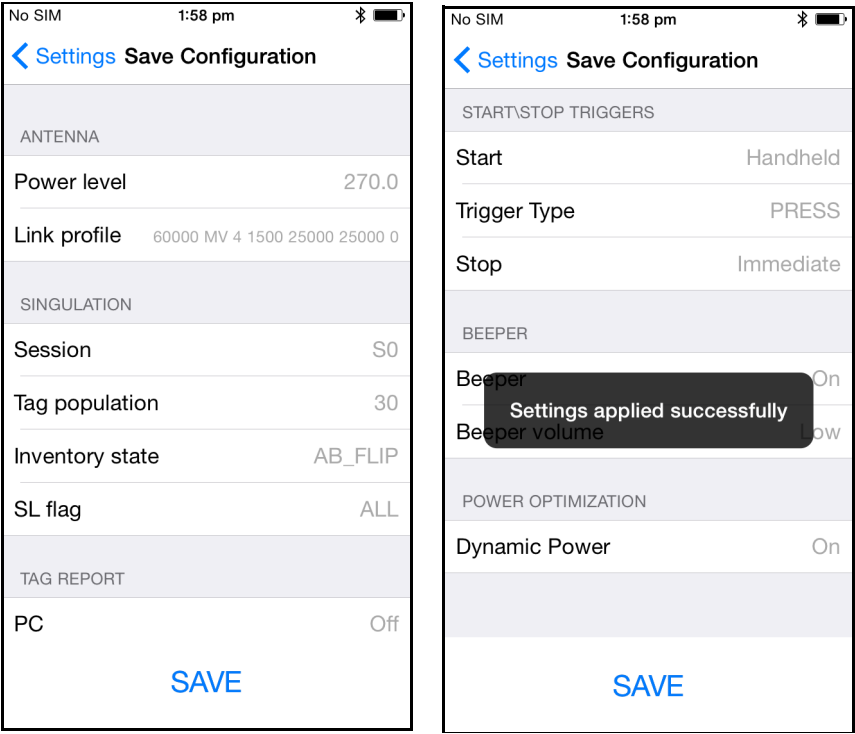

Figure 4-17 Settings - Save Configuration Screens

This screen can be used to save the settings and get a snapshot of current settings on the RFD8500. The settings persist on RFD8500 until the user performs a hard reset of the unit.

Locate Reader

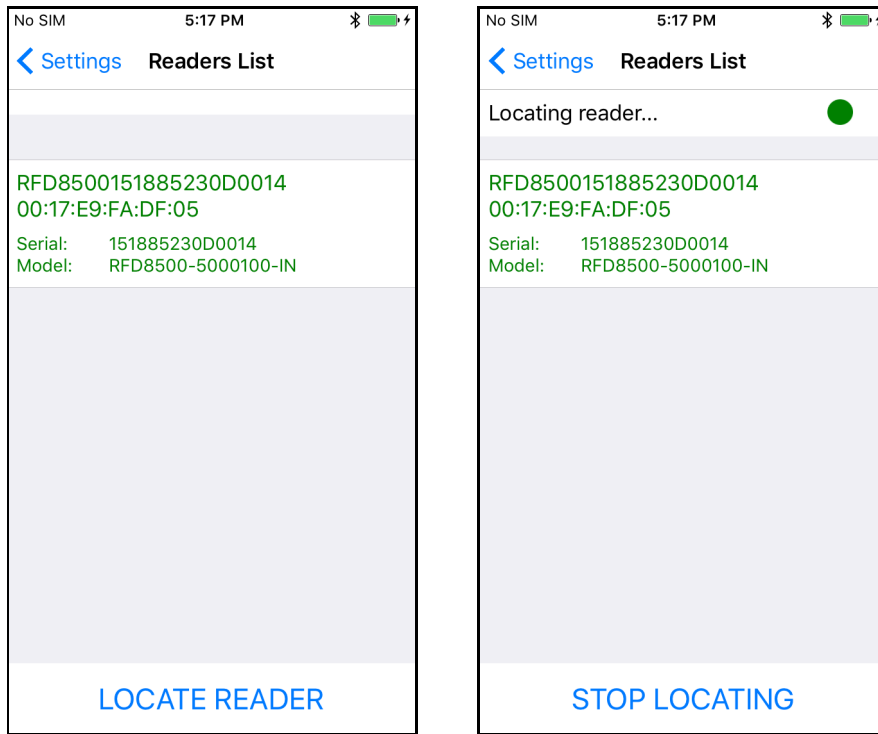

Figure 4-18 Settings - Locate Reader Screens

When the RFD8500 is connected to an iPhone, the Locate Reader option allows the user to identify a connected RFD8500. Select an RFD8500 device in the list and press **LOCATE READER**.

The selected reader sounds five long tones, one second each, and the LED on the device flashes amber until the user presses **STOP LOCATING** on the iPhone.

Access Control

✓ **NOTE** DPO must be disabled from the *Power Management* screen to allow access operation functionality.

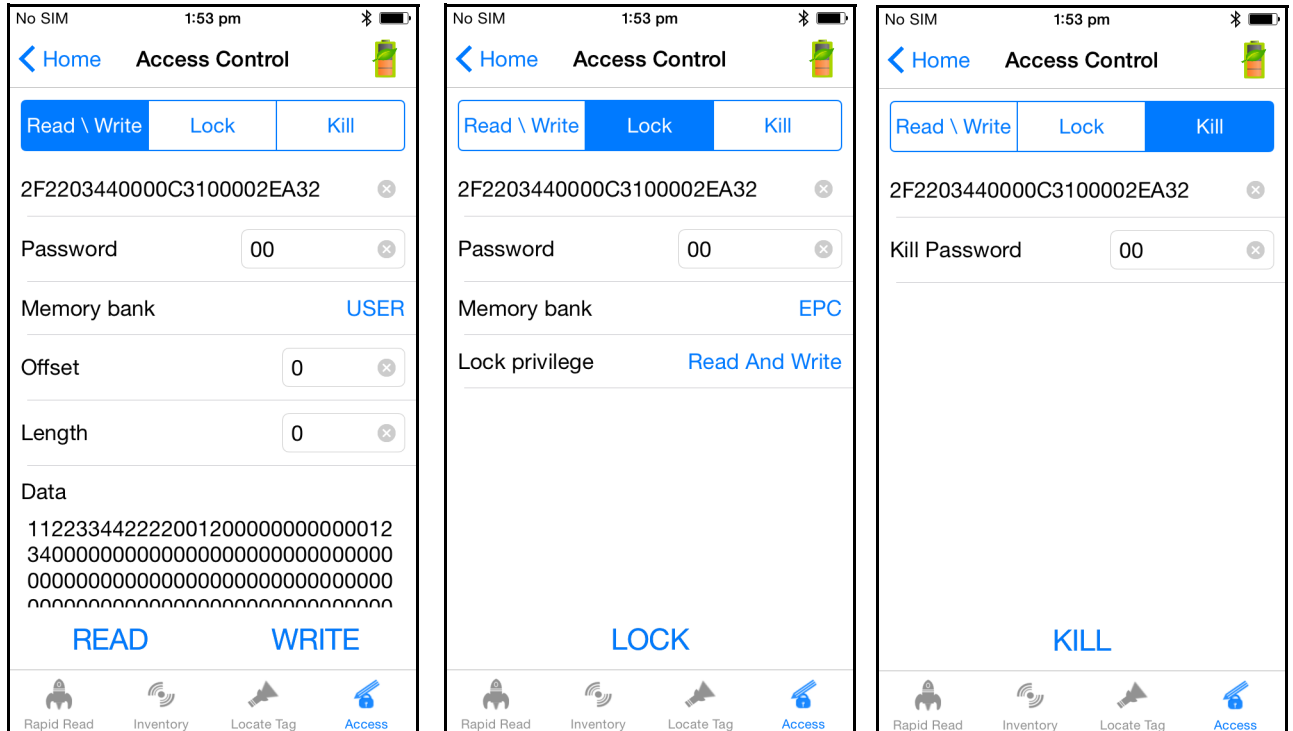

Figure 4-19 Access Control Screens - Read/Write; Lock; Kill Screens

The Tag Pattern area is automatically filled in when a tag is selected/highlighted in the *Inventory* screen.

Read/Write

- Tag ID & Password values are in hex. Tag ID is edited.
- Memory Bank options: EPC, RESERVED, TID and USER.
- Offset and Length values are in 16-bit words.

Lock

Lock privilege options:

- Read and Write
- Permanent Lock
- Permanent Unlock
- Unlock.

Kill

Permanently renders the tag unusable. A kill password must be provided.

Pre Filters

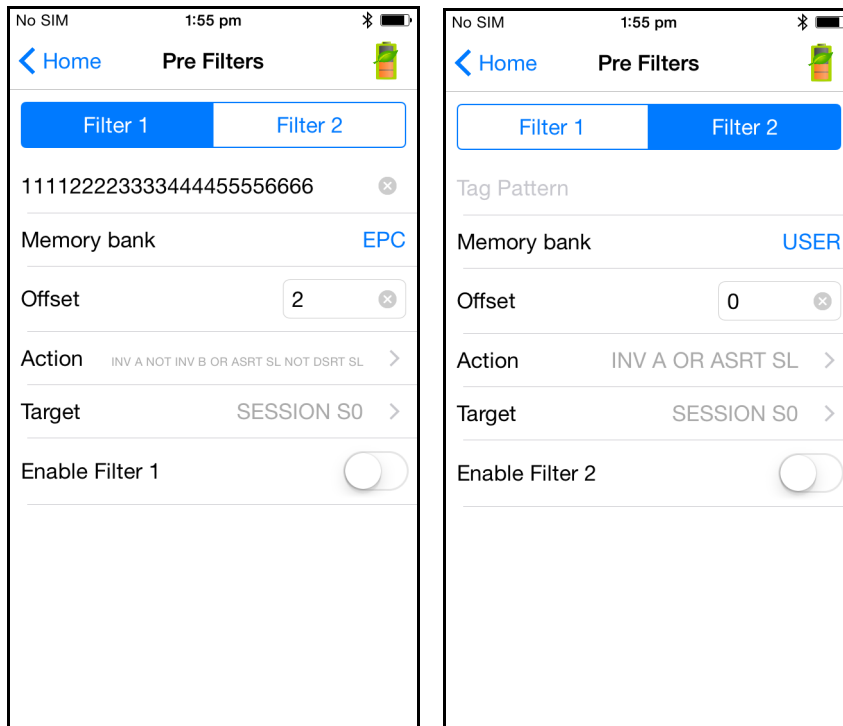

Figure 4-20 Pre Filters Screen

Options

- *Memory Bank:* EPC, TID and USER.
- *Offset:* Offset in the memory bank is specified in words.
- *Action:*
 - INV A NOT INV B or ASRT_SL_NOT_DSRT_SL
 - INV A or ASRT SL
 - NOT INV B or NOT DSRT SL
 - INV A2BB2A NOT INV A or NEG SL NOT ASRT SL
 - INV B NOT INV A or DSRT SL NOT ASRT SL
 - INV B or DSRT SL
 - NOT INV A or NOT ASRT SL
 - NOT INV A2BB2A or NOT NEG SL
- *Target:* SESSION S0, SESSION S1, SESSION S2, SESSION S3 & SL FLAG.

Up to two *Pre Filters* can be enabled.

About

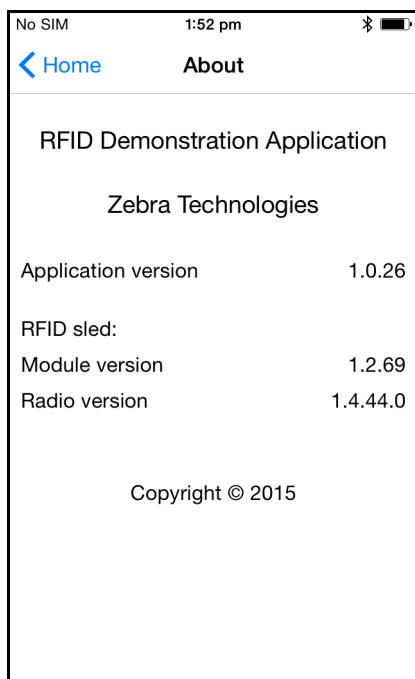

Figure 4-21 *About Screen*

This screen displays version information as reported by the RFD8500.

Chapter 5 ZEBRA RFID MOBILE APPLICATION for Windows

Introduction

This chapter describes the *Zebra RFID Mobile Application for Windows* that can be used with the RFD8500.

There are five applications:

- 123RFID Mobile Application for Android
- Zebra RFID Mobile Application for iOS
- Zebra RFID Mobile Application for Windows
- Zebra Scanner Control Application for iOS
- Zebra Scanner Control Application for Android.

When using a partner application, the features/functionality might vary.

Using the Zebra RFID Mobile Application for Windows

This application runs on Windows mobile devices and demonstrates RFD8500 capability and tag operation functionality.

The application allows the user to navigate to all screens (except to some screens within the *Settings* page), whether or not the device is connected to the RFD8500 reader.

The *Settings* screens display the application defaults when there is no connection to the reader. When not connected, an attempt to perform any operation (*Rapid Read, Inventory, Locate tag, Access Operations, Save Configuration, Battery Status*) displays *No Active Connection with Reader*.

To use this application for RFID operations:

1. Ensure the *Zebra RFID Mobile Application for Windows* is installed on the mobile device.
2. Ensure the RFD8500 is in RFID mode.
3. Pair the mobile device with the RFD8500 over Bluetooth (see [Pairing on page 2-5](#)).
4. Launch the *Zebra RFID Mobile Application for Windows* on the mobile device.

5. Select *Settings > Readers List* and select the RFD8500 device to connect.
6. Return to the *Home* screen and select *Settings > Antenna*. *Power Level* is set to 27.0 dBm by default. Japan units are set to a different default power level depending on the SKU type.
7. Before using the device set the region in which the device is operating. To set the region, open the application and select *Settings > Regulatory* (see [Regulatory on page 5-14](#)).

Home Screen

To access the *Zebra RFID Mobile Application for Windows*, touch the application icon () on the mobile device to display the *Home* screen. Touch any icon to access its screen.

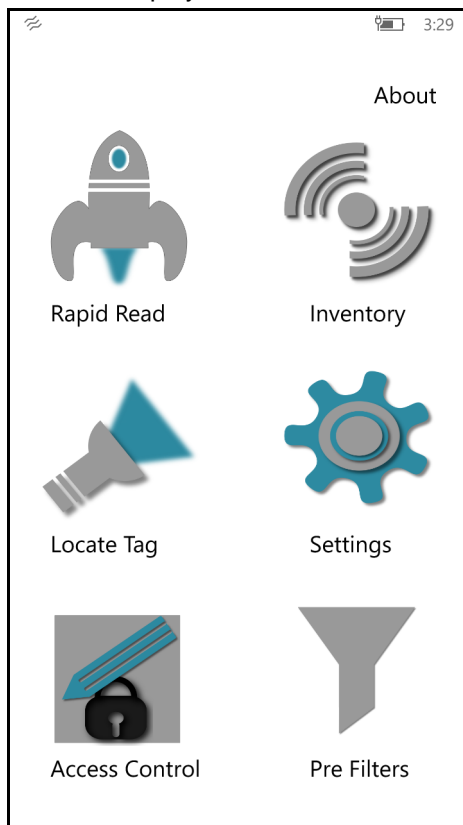

Figure 5-1 *Home Screen*

Rapid Read

Touch *Rapid Read* from the *Home* screen.

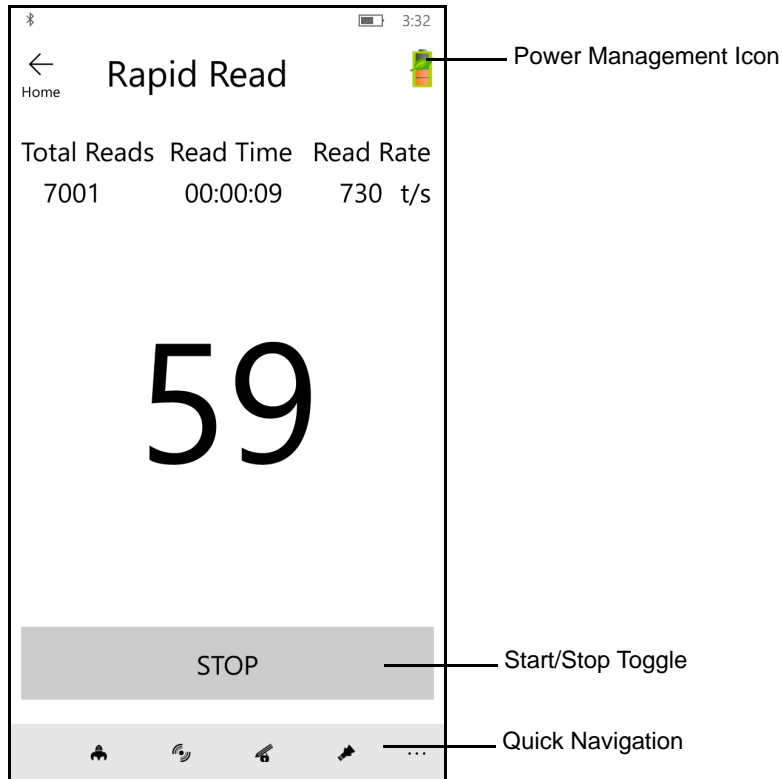

Figure 5-2 *Rapid Read* Screen

The *Rapid Read* and *Inventory* screens display the following data (see [Inventory on page 5-4](#)).

- Dynamic Power Optimization (DPO) status - When enabled, battery life is enhanced when performing inventory operations.
- Total tag count
- Read time (mm:ss)
- Tag read rate (tags/sec)
- Unique tag count (displays in the center of screen).

Rapid Read and *Inventory* screens are two different views of the inventory operation on the reader. The start/stop functionality can be used interchangeably on both screens. For example, when the user starts the operation on the *Rapid Read* screen and navigates to the *Inventory* screen, the button available on the *Inventory* screen is **STOP**. The same is true when the operation starts on the *Inventory* screen. During the rapid read process the user can navigate to the *Inventory* screen to view tag details along with tag counts for each tag. The statistics displayed are maintained on the *Rapid Read* and *Inventory* screens regardless of the screen used to start the process.

Touch **START** to start the rapid read inventory operation. Touch **STOP** to stop.

- ✓ **NOTE** The scan trigger on the RFD8500 can also start and stop the inventory operation. The reader must be in RFID mode. Press the trigger to start, and press again to stop.

Moving to another screen does not halt the operation. However, attempting to make changes or perform another operation while rapid read is in process results in an error.

Inventory

Touch **Inventory** from the **Home** screen or **Quick Navigation Bar**.

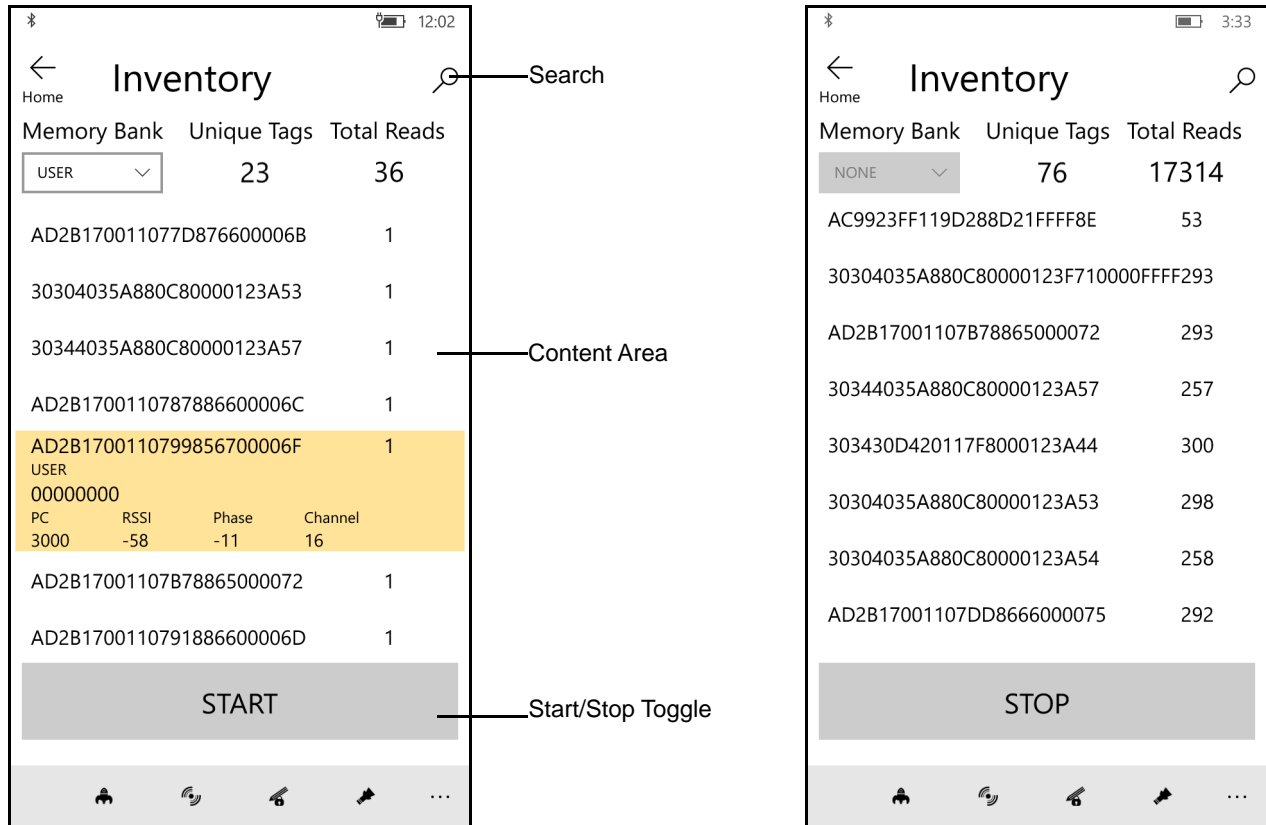

Figure 5-3 Inventory Screen

Tag reading can be started and stopped on this screen as well as on the **Rapid Read** screen (see [Rapid Read on page 5-3](#)). When the process starts, tag information displays on the screen.

Touch **START** to start the rapid read inventory operation. The button changes to **STOP**. Touch it to stop the read inventory operation.

- ✓ **NOTE** The scan trigger on the RFD8500 can also start and stop the inventory operation. The reader must be in RFID mode. Press the trigger to start, and press again to stop.

For inventory in Batch mode, the message Inventory started in Batch Mode displays and the tag data displays upon stop.

The tag ID selected displays on **Locate Tag** screen when navigating to that screen (see [Locate Tag on page 5-6](#)).

Inventory Screen Features

Table 5-1 *Features on the Inventory Screen*

Item	Description												
Action Bar													
Tags	<p>Touch the Memory Bank section and select one of the following memory bank options from the drop-down menu:</p> <ul style="list-style-type: none"> • None - Defaults to EPC. • User - Type of tag in the Memory Bank • Reserved - Type of tag in the Memory Bank • TID - Type of tag in the Memory Bank • EPC - Type of tag in the Memory Bank <p>When the next inventory operation starts, the details from the selected memory bank displays. This menu is inactive if there is an ongoing operation on the connected reader.</p> <p>Default Display: None</p>												
Search	Touch the <i>Search</i> icon and enter a tag ID. Tags that match the entry display in the content area.												
Content Area (select a tag)	Touching a <i>Tag ID</i> highlights the tag. The highlighted <i>Tag ID</i> is populated on the <i>Tag Location</i> text area. Touch START to start searching for the tag. See Locate Tag on page 5-6 for more details. From this screen return to the <i>Menu</i> or go to the <i>Home</i> screen and select <i>Locate Tag</i> .												
Content Area (select a tag)	<p>The tags displayed in this area are based on the option selected from the memory bank. Touch the tag ID to expand details about the tag. Touch the tag ID again to collapse details. Tag report elements that are not requested are shown.</p> <p>Example Default Tag Display:</p> <table border="0" style="width: 100%;"> <tr> <td style="width: 60%;">Tag ID</td> <td style="width: 40%; text-align: right;">Tag Count</td> </tr> <tr> <td>AD99 1540419072596540040</td> <td style="text-align: right;">4</td> </tr> </table> <p>Example Expanded Tag Display:</p> <p>Note: Expanded tag detail can only display when the inventory operation is stopped. Memory bank data is shown only when inventory is done with that option.</p> <p>"AD99 1540419072596540040"</p> <p>"ACCESS DATA"</p> <p>"1122334455667788AABBCCDDEEFF"</p> <table border="0" style="width: 100%;"> <tr> <td style="width: 15%;">Count</td> <td style="width: 15%;">PC</td> <td style="width: 15%;">RSSI</td> <td style="width: 55%;">Phase</td> </tr> <tr> <td>4</td> <td>3000</td> <td>-50</td> <td>1800</td> </tr> </table>	Tag ID	Tag Count	AD99 1540419072596540040	4	Count	PC	RSSI	Phase	4	3000	-50	1800
Tag ID	Tag Count												
AD99 1540419072596540040	4												
Count	PC	RSSI	Phase										
4	3000	-50	1800										

Locate Tag

Touch *Locate Tag* from the *Home* or *Menu* screen.



Figure 5-4 *Locate Tag Screen*

On this screen, enter the *Tag ID* in the text area or select a from the *Inventory* screen to pre-populate the *Tag ID* to search.

Touch **START** to start the locate tag operation. Touch **STOP** to stop. The RFD8500 trigger can also be used to start and stop the operation.

✓ **NOTE** The scan trigger on the RFD8500 can also start and stop the inventory operation. The reader must be in RFID mode. Press the trigger to start, and press again to stop.

The color bar on the display shows the relative distance of the tag.

When the locate tag operation starts, moving to another screen does not stop the operation until Stop is pressed.

The *Power Management* icon indicates whether Dynamic Power Optimization is enabled. When enabled, battery life is enhanced when performing inventory operations.

Settings

Touch *Settings* from the *Home* screen.

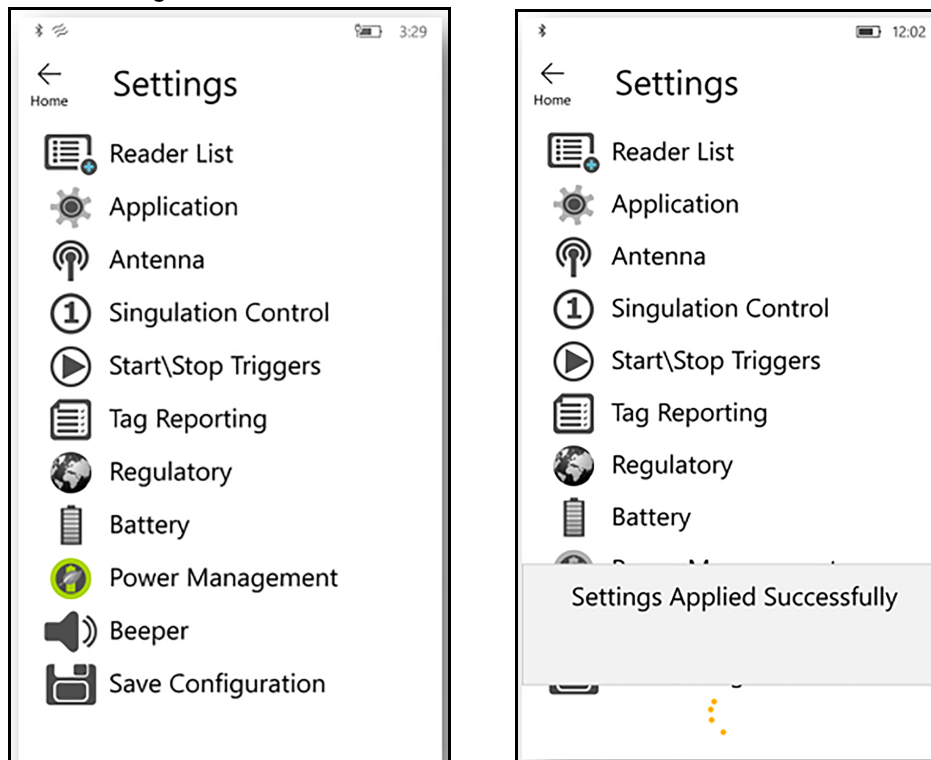

Figure 5-5 *Settings Screen*

Table 5-2 *Settings Screen Options*

Settings Option	Description	Page
Readers List	Displays all previous and new RFD8500 readers with which the mobile device paired.	5-8
Application	Displays reader connection, notification, and Data Export Settings.	5-9
Antenna	Displays antenna power lever and link profile.	5-10
Singulation Control	Displays <i>Session</i> , <i>Tag Population</i> , <i>Inventory State</i> and <i>SL Flag</i> .	5-11
Start\Stop Triggers	Allows START and STOP button control.	5-12
Tag Reporting	Allows the user to control the optional fields reported as part of the Tag Data.	5-13
Regulatory	Allows region and channel selections.	5-14
Battery	Displays the RFD8500 battery status.	5-15

Table 5-2 *Settings Screen Options (Continued)*

Settings Option	Description	Page
Beeper	Use to turn the beeper on/off, and set volume.	5-17
Power Optimization	Turns Dynamic Power Optimization on and off.	5-16
Save Configuration	Allows the user to save all settings: <i>Antenna, Singulation, Tag Reporting, START/STOP trigger, Beeper Volume, and Regulatory.</i> Note: The settings are also automatically saved when the user changes anything.	5-18

Readers List

From the *Settings* screen, touch *Readers List*.

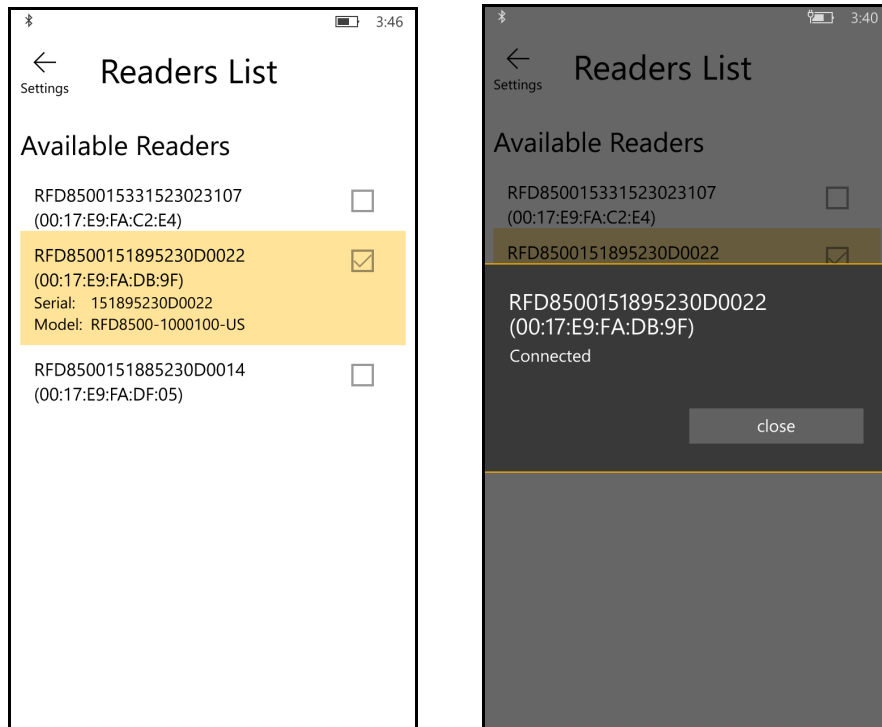
**Figure 5-6** *Settings - Readers List Screen*

This screen displays all available Bluetooth paired RFD8500 readers. The list includes the readers' serial and model numbers.

Touch a reader name from the list to establish a session with the selected reader; touch again to terminate the session. Touching a second reader in the list disconnects the currently connected reader and attempts to establish a connection to the newly selected reader.

Application

From the *Settings* screen, touch *Application*.

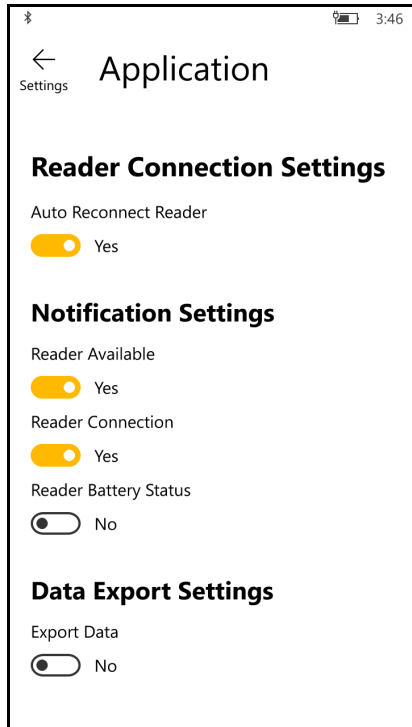

Figure 5-7 *Settings - Application Screen*

The default *Application* setting is *Reader Battery Status*.

The application always detects readers that were paired over Bluetooth.

Data Export Settings enable and disable exporting RFID data captured in the *Rapid Red* and *Inventory* screens. Enabling *Export Data* creates a file in the Windows device which can be copied by connecting the Windows 10 device to a PC.

Antenna

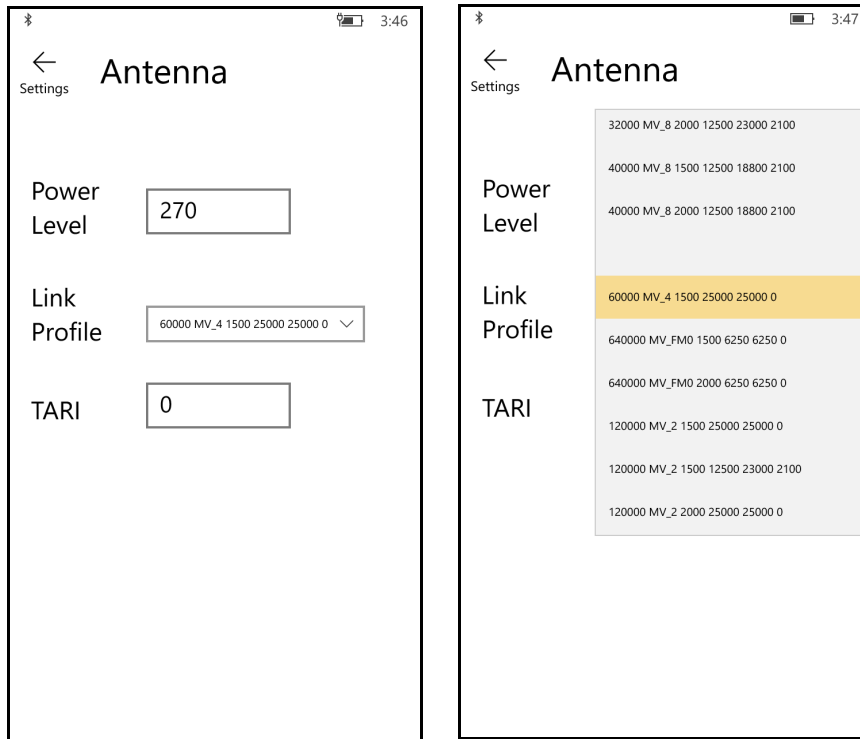

Figure 5-8 Settings - Antenna Screen

This screen displays:

- *Power Level* displays the current selection and includes a drop-down list of available power levels (as reported by RFD8500). 27.0 dBm is the default setting, and it is shown as 270 because the value used is in units of tens of dBm. Japan units are set to a different default power level depending on the SKU type.
- *Link Profile* displays the current selection and includes a drop-down list of available link profiles supported by the RFD8500.

Link Profile display format is as follows: Return link bit data rate in bis per second (e.g., 60000 -> 60 Kbs); Miller Value (e.g., MV_4 -> Miller 4); modulation type (PR ASK is the only one supported); PIE value has no units and is either 1.5 or 2 (e.g., 1.5 -> 1500 and 2 -> 2000); minimum Tari value in thousands of micro seconds (e.g., 6250 -> 6.25 microseconds); maximum Tari value in thousands of micro seconds; Tari step value in thousands of micro seconds. If the step value is zero, then Tari is fixed for this link profile. If the step size is non zero, then the default Tari value is the minimum value.

- Tari indicates the supported Tari for the chosen link profile.

The *Power Level* and *Link Profile* are blank when there is no connection to the reader.

Singulation Control

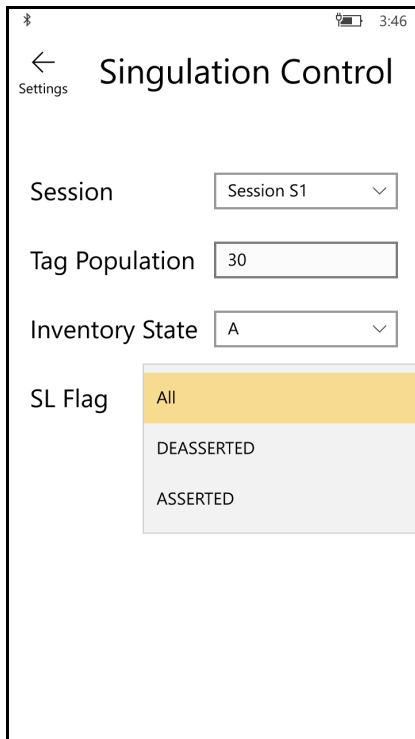

Figure 5-9 Settings - Singulation Control Screen

Use this screen to view/configure the singulation control settings for each antenna.

- *Session* options. The drop-down list includes the available options (S0, S1, S2, S3).
- *Tag Population*. A numeric value of the estimated number of tags in the Field of View (FOV). Values shown are 30,100,200,300,400,500,600.
- *Inventory State* options. State A & State B, AB FLIP
- SL flag options: ALL, DEASSERTED, ASSERTED

All values can be selected from the drop-down lists.

Start\Stop Triggers

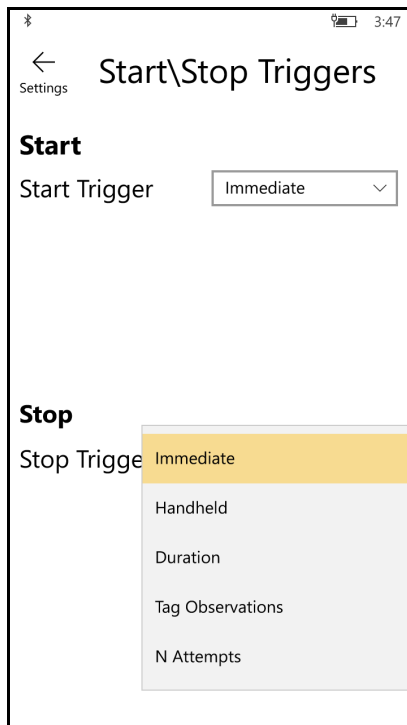

Figure 5-10 Settings - Start/Stop Triggers Screen

If the user does not enter all the required details for saving triggers to the reader, the application does not save the trigger settings to the reader.

- Start Trigger - the user can select one of the start trigger types below.
 - Immediate.
 - Hand-held - User should select either the *Trigger Pressed* or *Trigger Released* check box. If the start trigger type is hand-held trigger (pressed or released) the application sets the repeat for the operation to ensure the use case if repeated operations can be demonstrated.
 - Periodic - User should enter the period of time in milliseconds.
- Trigger Type - the user can select either *PRESS* or *RELEASE*, available when the *Start Trigger* is configured for *Handheld*.
- Stop Trigger - the user can select one of the stop trigger types below.
 - Immediate.
 - Hand-held - User should select either the *Trigger Pressed* or *Trigger Released* check box along with *Timeout* in milliseconds.
 - Duration - User should enter duration in milliseconds.
 - Tag Observation - User should enter the tag count along with timeout in milliseconds.
 - N Attempts - User should enter the number of attempts along with timeout in milliseconds.

Tag Reporting

These selections drive what the user sees on the *Inventory* screen.

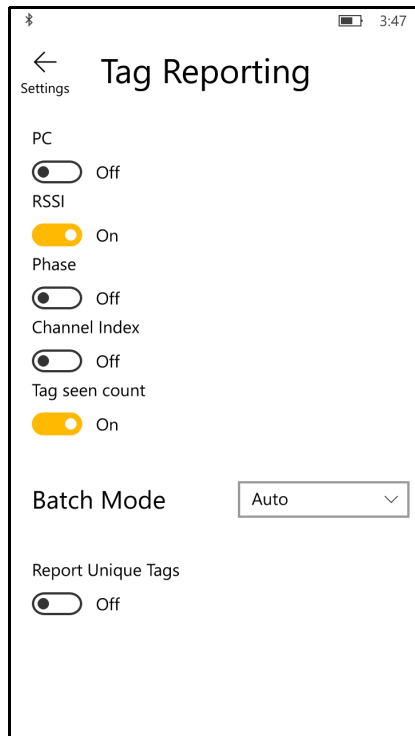

Figure 5-11 Settings - Tag Reporting Screens

Regulatory

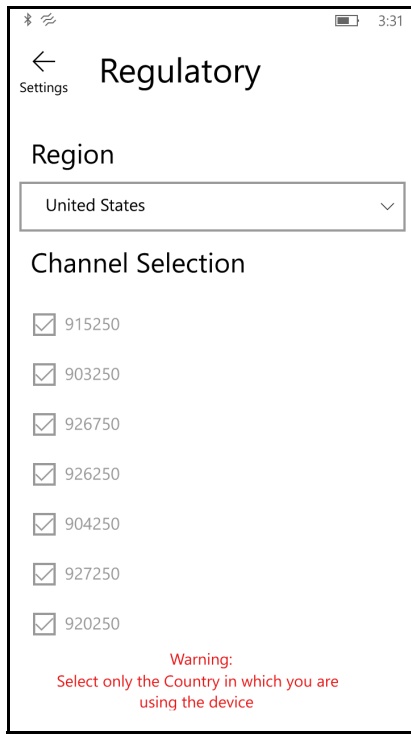

Figure 5-12 Settings - Regulatory and Regions Screens

The region drop-down displays the current region to which the device is set. Choose the correct region before using the device.

- Channel selection is allowed only for the regions that allow channel setting.
- Supported regions are reported by the RFD8500.
- If the region is not configured on the RFD8500 the *Regulatory* screen is the first screen displayed after connecting to the RFD8500.

Battery

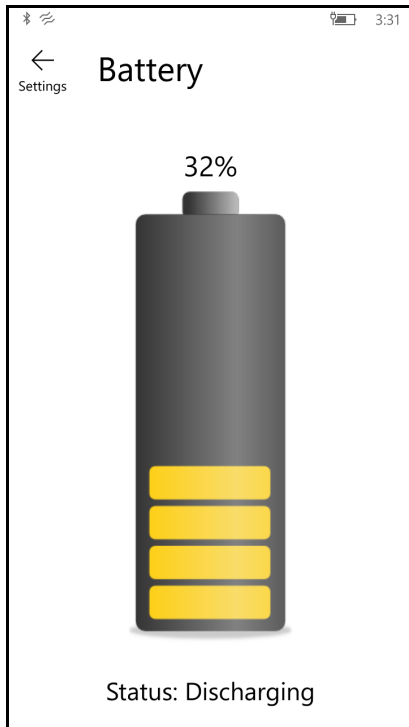

Figure 5-13 Settings - Battery Screen

This screen displays the status of the battery in the RFD8500.

- Level is 100% (in green): *Status: Battery is fully charged.*
- Charging (in green): *Status: Charging.*
- Discharging (in green): *Status: Discharging.*
- Critical (in red): *Status: Battery Level is Critical.*
- Low (in red): *Status: Battery Level Low.*
- Reader is not connected (in grey): *No Active Connection.*

Power Management

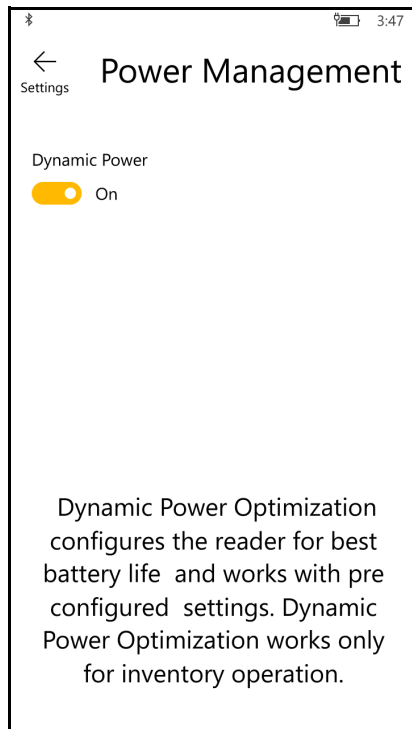

Figure 5-14 Settings - Power Management Screen

This screen provides an option to enable dynamic power optimization (DPO) in the reader. Enabling DPO enhances battery life when performing inventory operations.

✓ **NOTE** DPO is enabled by default. With DPO enabled, access operations and filters/singulation setting changes do not take effect.

If Dynamic Power is on, a green battery icon appears in the title bar of the application. Clicking on this opens the *Battery Status* screen.

Beeper

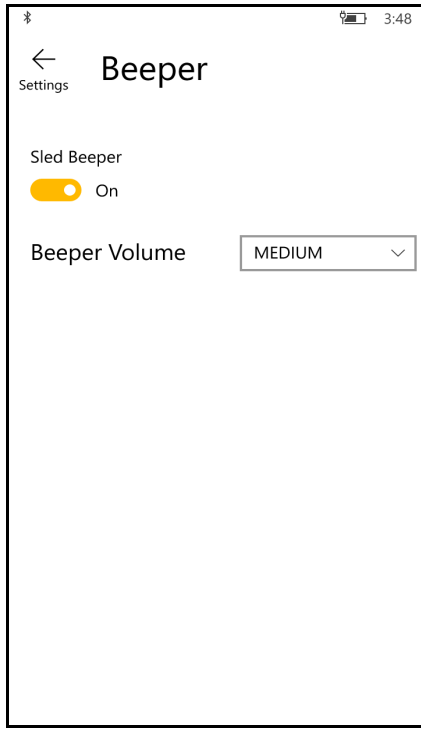

Figure 5-15 Settings - Beeper Screen

This screen displays the current beeper settings. The user can turn the beeper off (by unchecking the *Sled Beeper* check box), or set the volume to *High*, *Medium* or *Low*.

Save Configuration

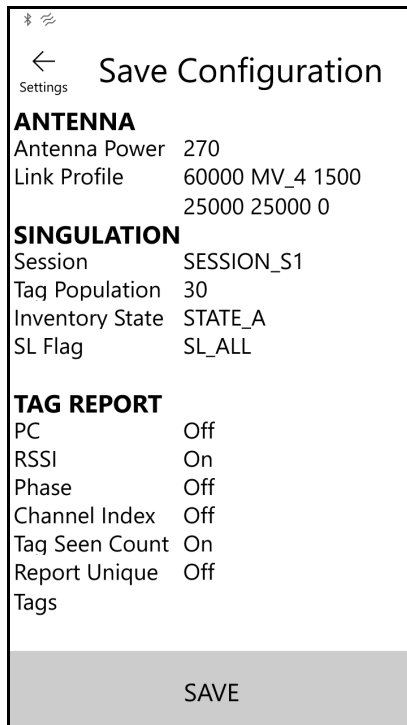

Figure 5-16 Settings - Save Configuration Screens

This screen can be used to save the settings and get a snapshot of current settings on the RFD8500.

The settings persist on RFD8500 until the user performs a hard reset of the unit.

Access Control

- ✓ **NOTE** DPO must be disabled from the *Power Management* screen to allow access operation functionality.

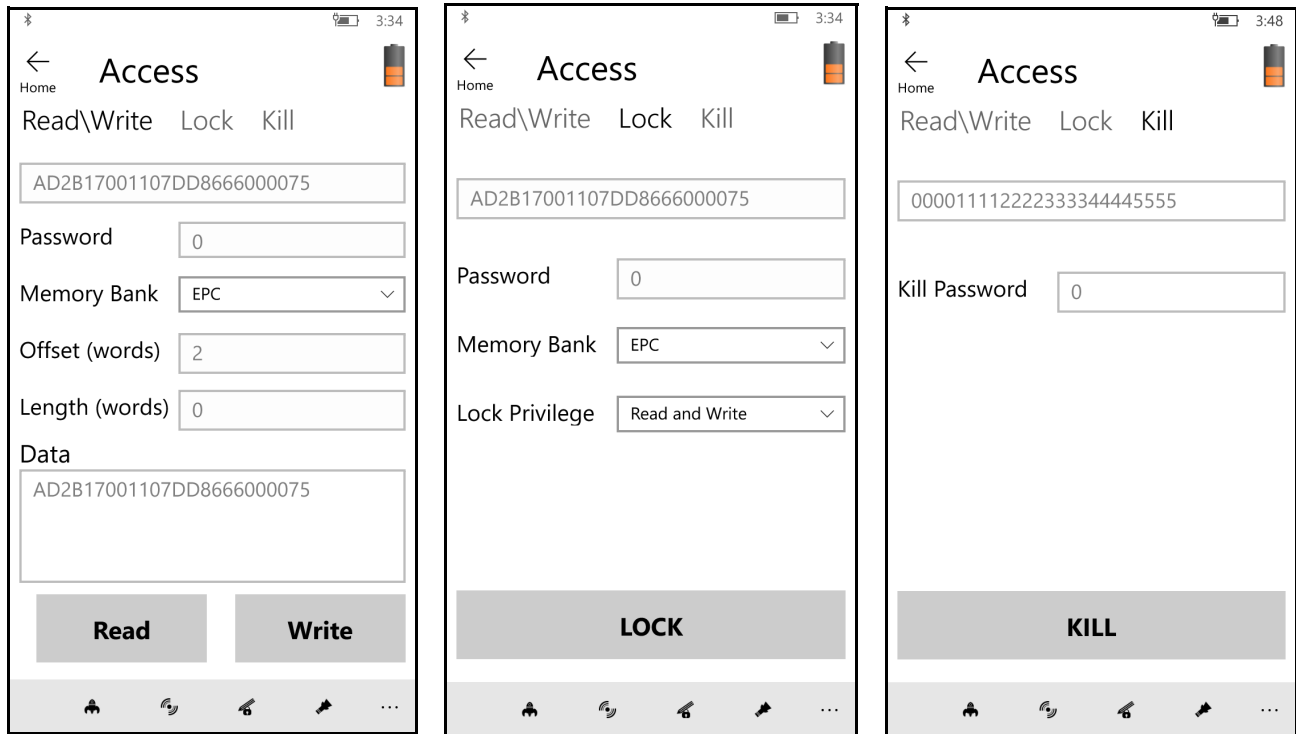

Figure 5-17 Access Control Screens - Read/Write; Lock; Kill Screens

The Tag Pattern area is automatically filled in when a tag is selected/highlighted in the *Inventory* screen.

Read/Write

- Tag ID & Password values are in hex. Tag ID is edited.
- Memory Bank options: EPC, RESERVED, TID and USER.
- Offset and Length values are in 16-bit words.

Lock

Lock privilege options:

- Read and Write
- Permanent Lock
- Permanent Unlock
- Unlock.

Kill

Permanently renders the tag unusable. A kill password must be provided.

Pre Filters

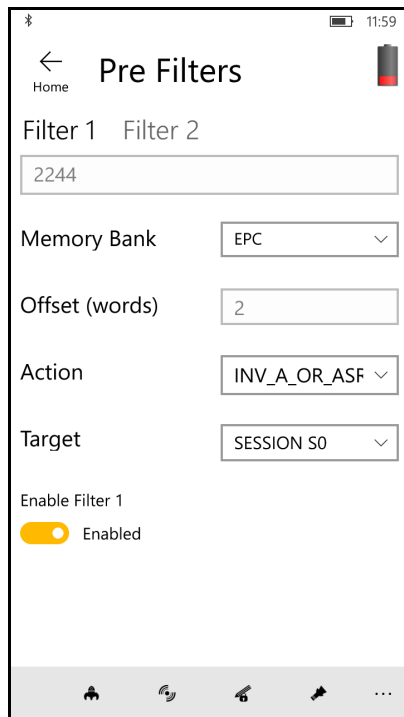

Figure 5-18 Pre Filters Screen

Options

- *Memory Bank:* EPC, TID and USER.
- *Offset (words):* Offset in the memory bank is specified in words.
- *Action:*
 - INV A NOT INV B or ASRT_SL_NOT_DSRT_SL
 - INV A or ASRT SL
 - NOT INV B or NOT DSRT SL
 - INV A2BB2A NOT INV A or NEG SL NOT ASRT SL
 - INV B NOT INV A or DSRT SL NOT ASRT SL
 - INV B or DSRT SL
 - NOT INV A or NOT ASRT SL
 - NOT INV A2BB2A or NOT NEG SL
- *Target:* SESSION S0, SESSION S1, SESSION S2, SESSION S3 & SL FLAG.

Up to two Pre Filters can be enabled.

Notification Area Updates

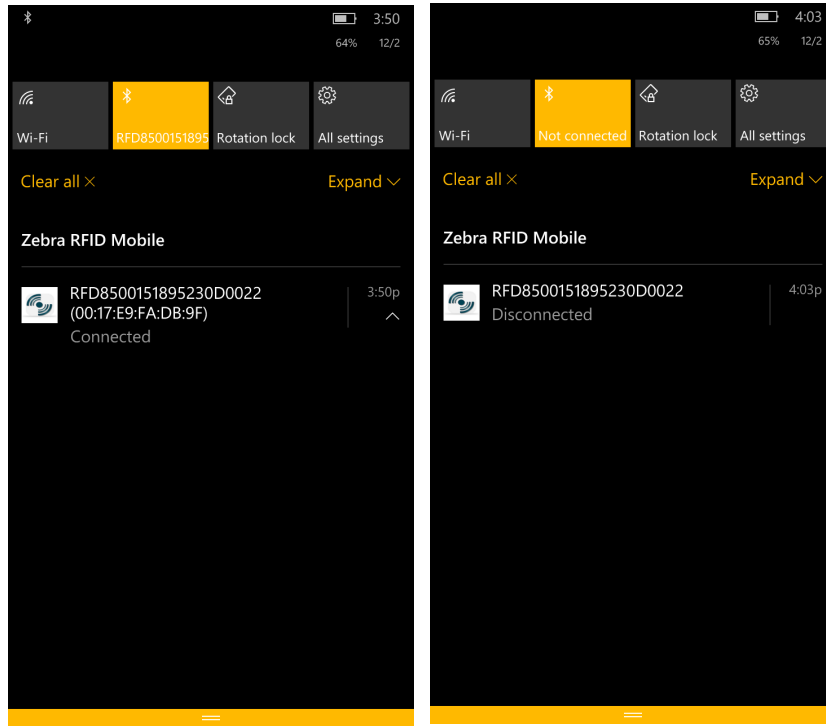

Figure 5-19 Bluetooth Connection Status in Notification Area - Updated by the Application

About

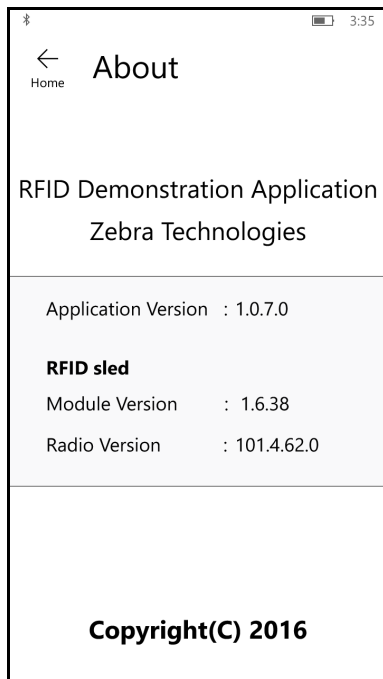

Figure 5-20 *About Screen*

This screen displays version information as reported by the RFD8500.

Chapter 6 ZEBRA SCANNER CONTROL APPLICATION for ANDROID

Introduction

This chapter describes the *Zebra Scanner Control Application for Android* application that can be used with the RFD8500.

✓ **NOTE** The content in this chapter applies to the Scanner Control Application v1.x.x.x series. For newer software versions and more detailed information, refer to the Running and Configuring the Scanner Control Application sections in the respective Developer Guides (see [Related Documents on page ix](#)).

There are five applications:

- 123RFID Mobile Application for Android
- Zebra RFID Mobile Application for iOS
- Zebra RFID Mobile Application for Windows
- Zebra Scanner Control Application for iOS
- Zebra Scanner Control Application for Android.

When using a partner application, the features/functionality might vary.

Using the Zebra Scanner Control Application for Android

This application runs on Android mobile devices and demonstrates RFD8500 capability for scanning bar codes.

The application allows the user to navigate to all screens whether or not the device is connected to the RFD8500 reader. All screens display the application defaults.

Touch < on any screen to return to the previous screen.

To use the application:

1. Ensure the application is installed on the mobile device.
2. Ensure the RFD8500 is turned on and in range.
3. Pair the mobile device with the RFD8500 (see [Pairing on page 2-5](#)).
4. Ensure the RFD8500 is in bar code mode (see [Mode Button on page 1-3](#)).
5. Touch the *Zebra Scanner Control for Android* icon () on the mobile device to launch the *Home* screen ([Figure 6-1](#)).

Home Screen

When the application launches, the *Home* screen displays. Touch any option in the list to display its screen.

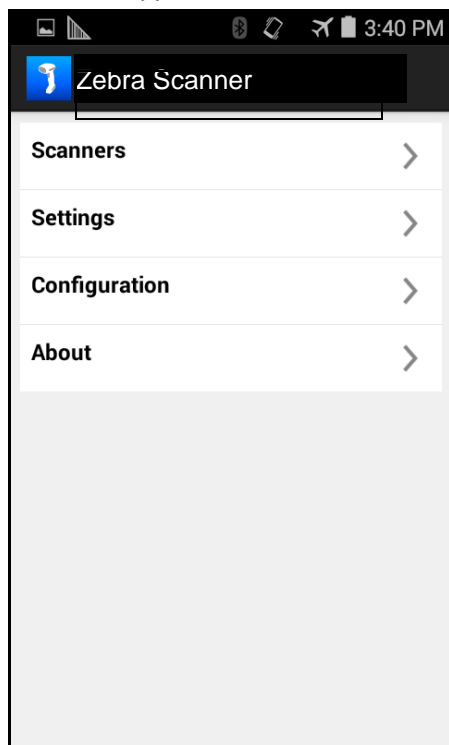

Figure 6-1 Home Screen

Scanners

Scanners Screen

To display the *Scanners* screen touch *Scanners* from the *Home* screen ([Figure 6-1](#)). The *Scanners* screen displays all scanners paired and connected to the mobile device. Select a device in the list to display the *Active Scanner* screen (see [Active Scanner Screen on page 6-6](#)). If no scanners were previously paired/connected, to the mobile device, a connection is required (see [Connecting the Mobile Device and the Scanner](#)).

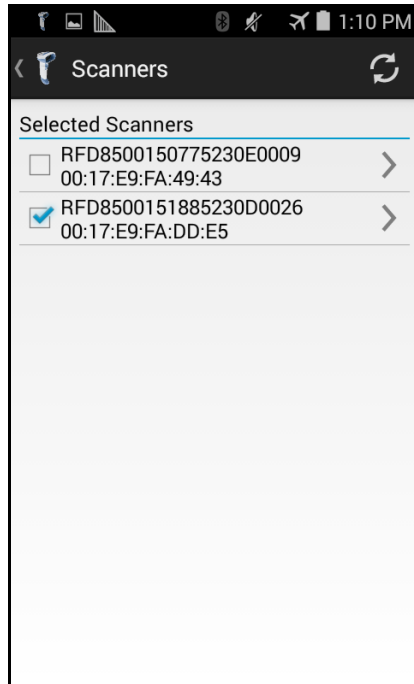

Figure 6-2 *Scanners Screen*

Connecting the Mobile Device and the Scanner

To connect the mobile device to the scanner:

1. Ensure the both devices are paired.
2. Touch *Scanners* from the *Home* screen (Figure 6-1). The following screen displays.

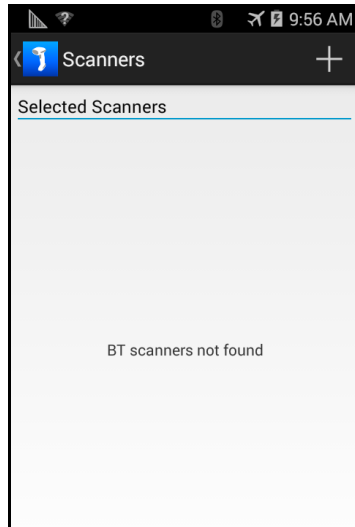

Figure 6-3 *Scanners Not Found*

3. Touch the plus sign (+) in the upper right corner of the *BT scanners not found* screen to select a paired scanner. Touch the scanner name/serial number in the *Select a Scanner* list to select the scanner.

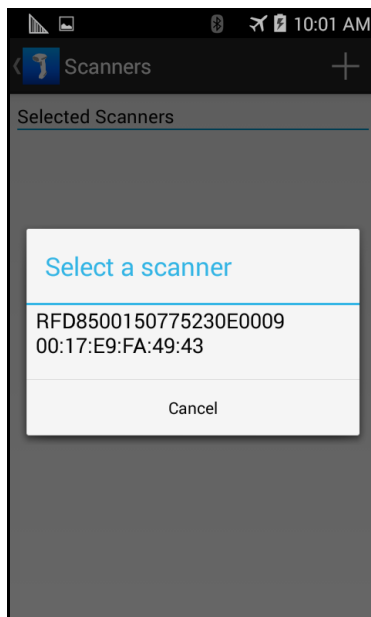

Figure 6-4 *Select a Scanner*

- The *Scanners* screen displays all scanners paired via Bluetooth with the mobile device. Touch the appropriate scanner (by serial number) to display the *Available Scanner Connect* screen ([Figure 6-5](#)).

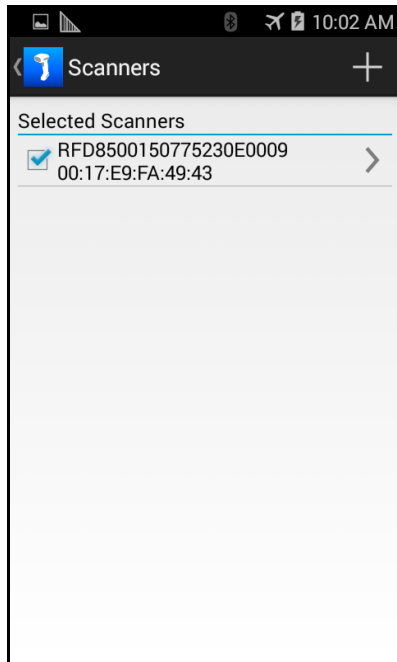

Figure 6-5 *Scanners Screen*

- Touch *Connect* to connect the scanner and the mobile device.

✓ **NOTE** If the scanner to which you want to connect is powered off, a message displays indicating the scanner is powered off. Click **OK** to close the message window, power on the scanner, and resume the process from [Step 1](#) to connect.

- When connected, the *Active Scanner* screen displays.

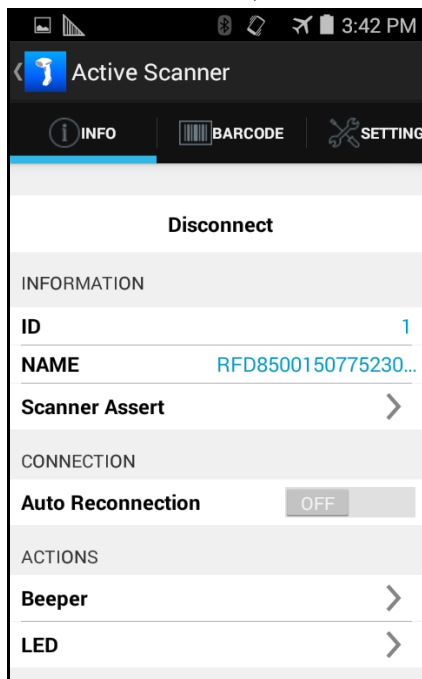

Figure 6-6 *Active Scanner Screen*

Active Scanner Screen

This screen displays information about the connected scanner and includes three tabs: INFO, BARCODE, and SETTINGS.

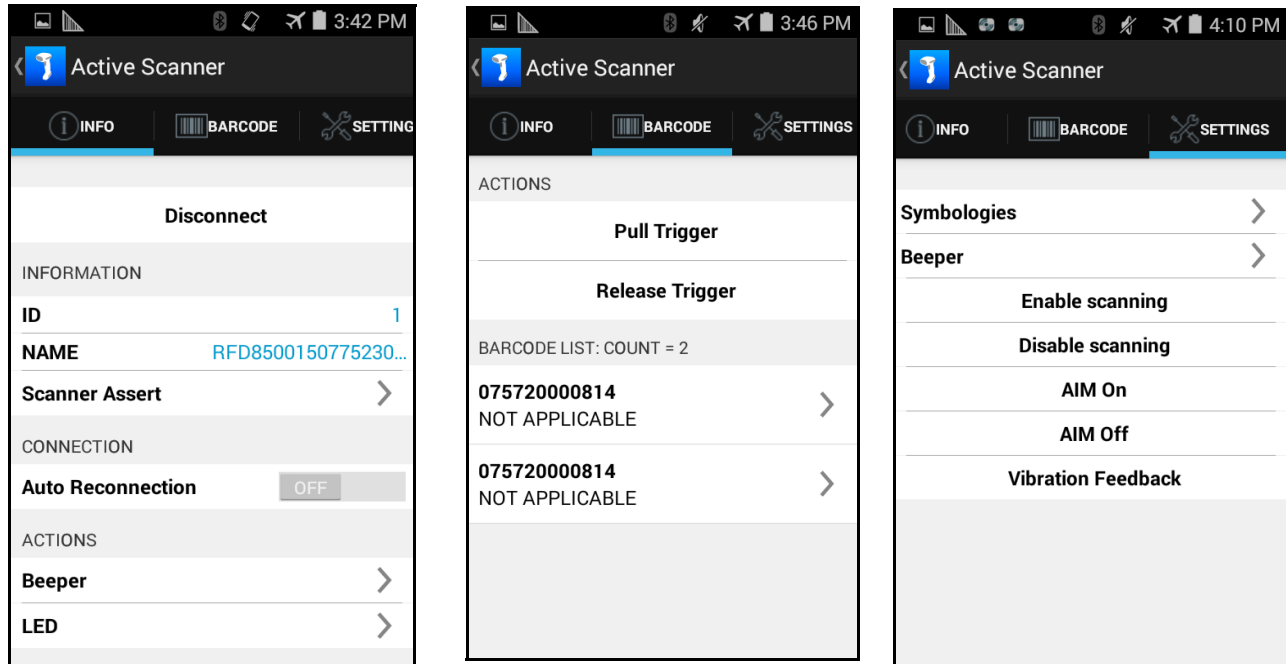

Figure 6-7 Active Scanner Screen - INFO, BARCODE, SETTINGS Tabs

INFO

Touch *INFO* to access the *INFO* tab. The *INFO* tab provides information about the connected scanner and allows the user input detailed in [Table 6-1](#).

Table 6-1 Active Scanner Screen - INFO Tab

Field	Description
Disconnect	Touch <i>Disconnect</i> to disconnect the scanner from the mobile computer.
ID	Unique identifier of the scanner assigned by the SDK.
NAME	Name and serial number of the scanner.
Asset Information	Touch <i>Asset Information</i> to display the scanner's: <ul style="list-style-type: none"> • Model • Serial number • Firmware version • Date of Manufacture • Configuration.

Table 6-1 Active Scanner Screen - INFO Tab (Continued)

Field	Description
Auto Reconnection	Slide the <i>OFF/ON</i> switch to turn auto reconnection on and off. In the <i>ON</i> position the mobile computer auto reconnects to the scanner.
Beeper	Touch <i>Beeper</i> and use your finger to scroll to the desired beeper tone. Touch <i>Select Beeper Action</i> to save the beeper selection. The selection determines the tones to sound when a bar code is decoded.
LED	Touch <i>Green LED ON</i> , or <i>Green LED OFF</i> to set the status of the Bar code/RFID Indicator (see Bar code/RFID Indicator on page 1-3). Note: LED control is not supported by the RFD8500.

BARCODE

Touch *BARCODE* to access the *BARCODE* tab. The *BARCODE* tab allows the user to scan items. [Table 6-2](#) includes descriptions of the option in this view.

Table 6-2 Active Scanner Screen - BARCODE Tab

Field	Description
Pull Trigger	Touch to turn on the imager decode functionality. The red illumination remains ON: <ul style="list-style-type: none"> - until a bar code is scanned. - the <i>Release Trigger</i> is touched. - until the decode session timeout. You can also use the trigger on the imager to scan bar codes.
Release Trigger	Touch to turn off the imager decode functionality (red illumination off).
BARCODE LIST: COUNT = X	X = the number of scanned bar codes.
Clear List	Touch to clear the list of bar codes.
Bar Code List	Each scanned bar code displays in a list with the bar code content and bar code type. Touch the bar code to display the data in a new screen.

SETTINGS

Touch **SETTINGS** to access the **SETTINGS** tab. The **SETTINGS** tab allows the user to configure the scanner. [Table 6-2](#) describes the options in this view.

Table 6-3 Active Scanner Screen - **SETTINGS** Tab

Field	Description
Symbologies	<p>Touch Symbologies to display the bar code types supported by the scanner.</p> <ul style="list-style-type: none"> • For each bar code type, slide the <i>OFF/ON</i> switch to the applicable position. • Select <i>Permanent</i> to save the settings. <p>Symbology Notes:</p> <ol style="list-style-type: none"> 1. For a complete list of symbologies and their corresponding settings (if any), configure the device via 123Scan. 2. When setting the <i>Inter Character Delay</i> for HID only, set the delay in milliseconds between emulated keystrokes. When pairing with an Android device, set the <i>Inter Character Delay</i> to 70 ms to avoid data loss.
Beeper	<p>Touch Beeper to display the beeper types supported by the scanner.</p> <ul style="list-style-type: none"> • Select the applicable beeper volume, and beeper frequency.
Miscellaneous Options	<p>Touch any of the following options to enable, or disable the feature.</p> <ul style="list-style-type: none"> • Enable scanning • Disable scanning • AIM On (auto aim on displays the red illumination before pulling the trigger) • Aim Off • Vibration Feedback

Settings

✓ **NOTE** Imaging and video is not supported by the RFD8500.

To display the *Settings* screen touch *Settings* from the *Home* screen ([Figure 6-1](#)).

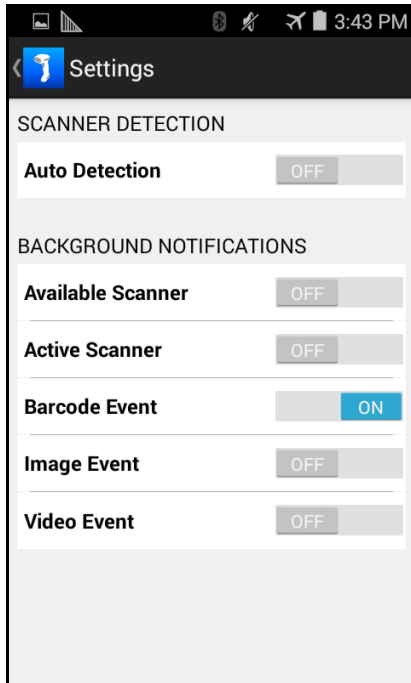

Figure 6-8 *Settings* Screen

Slide the OFF/ON switch to turn on and off scanner detection, and background notifications.

Configuration (Not Supported)

To display the *Scanner Configurations* screen touch *Configuration* from the *Home* screen ([Figure 6-1](#)).

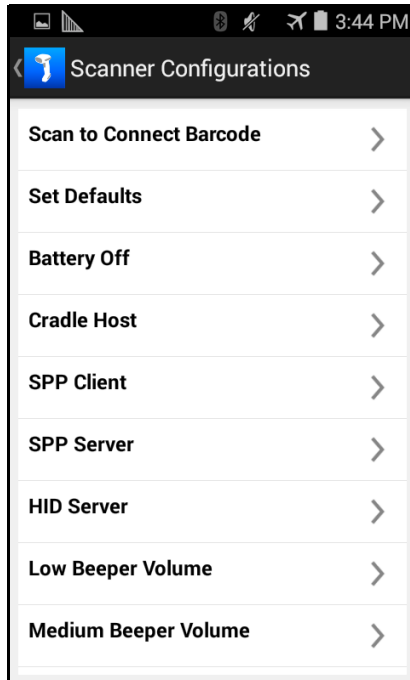

Figure 6-9 *Scanner Configurations Screen*

Selecting an option from this screen displays a bar code to scan that configures the scanner.

About

To display the *About* screen touch *About* from the *Home* screen ([Figure 6-1](#)).



Figure 6-10 *About Screen*

This screen displays version and copyright information.

Chapter 7 ZEBRA SCANNER CONTROL APPLICATION for iOS

Introduction

This chapter describes the *Zebra Scanner Control Application for iOS* that can be used with the RFD8500.

✓ **NOTE** The content in this chapter applies to the Scanner Control Application v1.x.x.x series. For newer software versions and more detailed information, refer to the Running and Configuring the Scanner Control Application sections in the respective Developer Guides (see [Related Documents on page ix](#)).

There are five applications:

- 123RFID Mobile Application for Android
- Zebra RFID Mobile Application for iOS
- Zebra RFID Mobile Application for Windows
- Zebra Scanner Control Application for iOS
- Zebra Scanner Control Application for Android.

When using a partner application, the features/functionality might vary.

Using the Zebra Scanner Control Application for iOS Application

This application runs on iOS devices and demonstrates RFD8500 capability for scanning bar codes.

The application allows the user to navigate to all screens whether or not the device is connected to the RFD8500 reader. All screens display the application defaults.

Touch < on any screen to return to the previous screen.

To use the application:

1. Ensure the application is installed on the device.
2. Ensure the RFD8500 is turned on and in range.
3. Pair the device with the RFD8500 (see [Pairing on page 2-5](#)).
4. Ensure the RFD8500 is in bar code mode (see [Mode Button on page 1-3](#)).
5. Touch the *Zebra Scanner for iOS* icon () on the device to launch the *Home* screen ([Figure 7-1](#)).

Home Screen

When the application launches the *Home* screen displays. Touch any option in the list to display its screen.

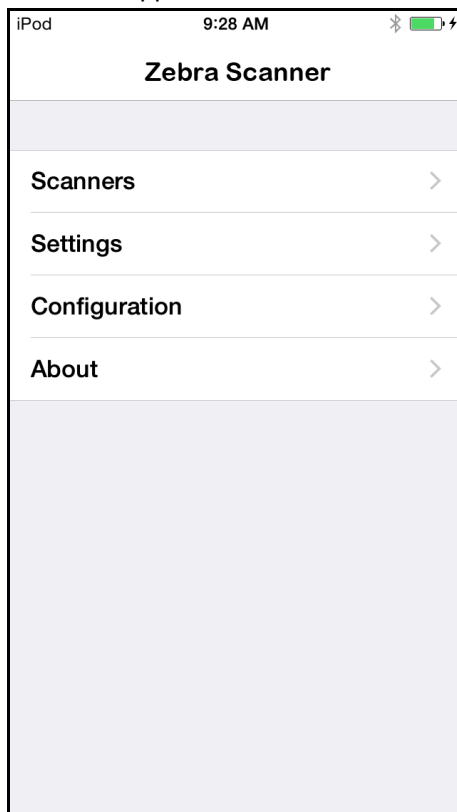

Figure 7-1 Home Screen

Scanners

Scanners Screen

To display the *Scanners* screen touch *Scanners* from the *Home* screen ([Figure 7-1](#)). The *Scanners* screen displays all scanners paired and connected to the device. Select a device in the list to display the *Active Scanner* screen (see [Active Scanner Screen on page 7-5](#)). If no scanners were previously paired/connected, to the device, a connection is required (see [Connecting the Device and the Scanner](#)).

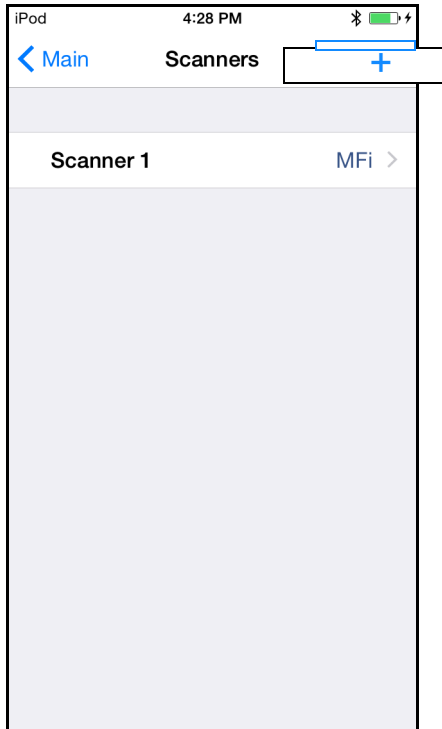

Figure 7-2 *Scanners Screen*

Connecting the Device and the Scanner

To connect the iOS device to the scanner:

1. Ensure the both devices are paired.
2. Touch *Scanners* from the *Home* screen (Figure 7-1). The following screen displays when the *Auto Detection* option is enabled.

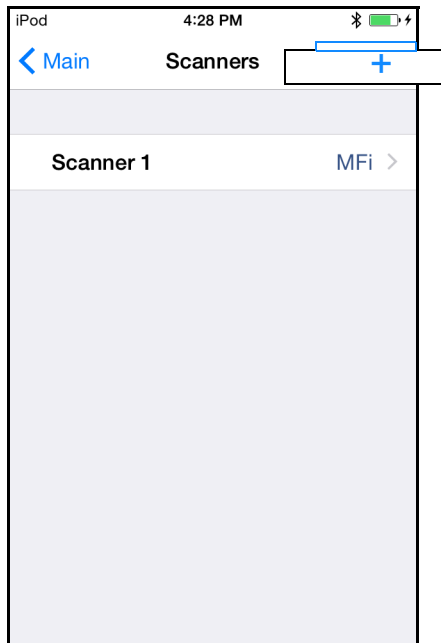

Figure 7-3 Scanners Screen

3. When the *Auto Detection* option is disabled, available devices don not automatically appear in the list. Touch the *Refresh* icon (🔄) in the upper right corner of the *Scanners* screen. The available scanner(s) now appear in the list.

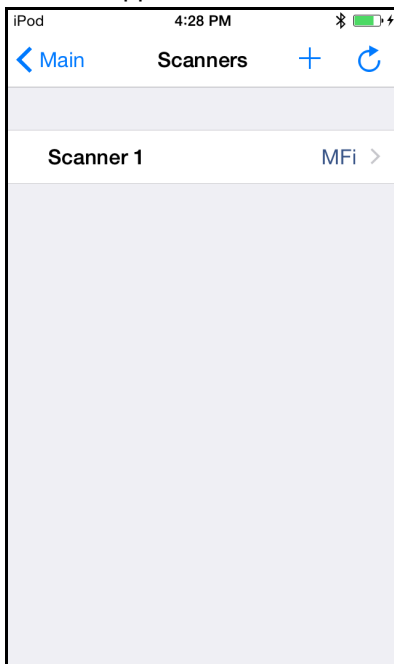





Figure 7-4 Select a Scanner

Active Scanner Screen

This screen displays information about the connected scanner and allows user input for Auto Reconnection, Beeper Tone, and LED control. The icons on the bottom of the display (  ) allow the user to access the *Info*, *Barcode*, and *Settings* screens.

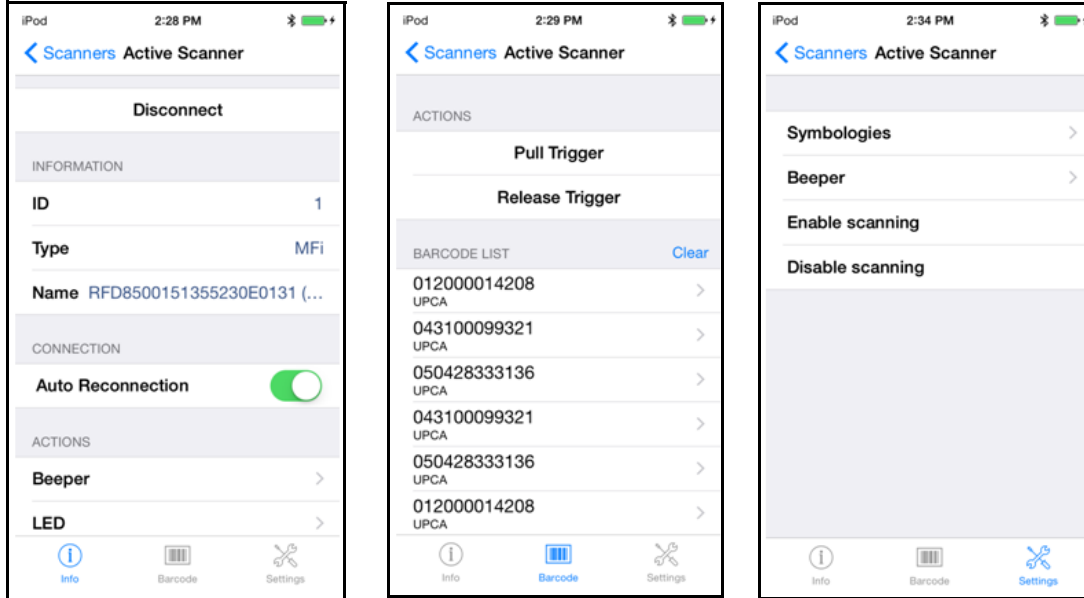

Figure 7-5 Active Scanner Screen - Info, Barcode, and Settings Views

Info

The *Info* view provides information about the connected scanner and allows the user input detailed in [Table 7-1](#).

Table 7-1 Active Scanner Screen - Info View

Field	Description
Disconnect	Touch <i>Disconnect</i> to disconnect the scanner from the mobile computer.
ID	Unique identifier of the scanner assigned by the SDK.
Type	Communication mode of the scanner.
Name	Name and serial number of the scanner.
Auto Reconnection	Slide the <i>OFF/ON</i> switch to turn auto reconnection on and off. In the <i>ON</i> position the mobile computer auto reconnects to the scanner.
Beeper	Touch <i>Beeper</i> and use your finger to scroll to the desired beeper tone. Touch <i>Beep</i> at the top of the screen to sound a sample of the tone on the RFD8500. The selection determines the tones to sound when a bar code is decoded. Touch the Back arrow (←) to return to the previous screen.
LED	Touch <i>[Color] LED ON</i> , or <i>[Color] LED OFF</i> to set the status of the Bar code/RFID Indicator (see Bar code/RFID Indicator on page 1-3). Touch the Back arrow (←) to return to the previous screen. Note: LED control is not supported by the RFD8500.

Barcode

The *Barcode* view allows the user to scan items. [Table 7-2](#) includes descriptions of the option in this view.

Table 7-2 *Active Scanner Screen - Barcode View*

Field	Description
Pull Trigger	Touch to turn on the imager decode functionality. The red illumination remains ON: <ul style="list-style-type: none"> - until a bar code is scanned. - the <i>Release Trigger</i> is touched. - until the decode session timeout. You can also use the trigger on the imager to scan bar codes.
Release Trigger	Touch to turn off the imager decode functionality (red illumination off).
Barcode List	List all scanned bar codes with the bar code type and content.

Settings

The *Settings* view allows the user to configure the scanner. [Table 7-2](#) describes the options in this view.

Table 7-3 *Active Scanner Screen - SETTINGS Tab*

Field	Description
Symbologies	Touch Symbologies to display the bar code types supported by the scanner. <ul style="list-style-type: none"> • For each bar code type, slide the <i>OFF/ON</i> switch to the applicable position (green is on). Symbology Notes: <ol style="list-style-type: none"> 1. For custom symbology settings, configure the device via 123Scan. 2. When setting the <i>Inter Character Delay</i> for HID only, set the delay in milliseconds between emulated keystrokes. When pairing with an Android device, set the <i>Inter Character Delay</i> to 70 ms to avoid data loss.
Beeper	Touch Beeper to display the beeper types supported by the scanner. <ul style="list-style-type: none"> • Select the applicable beeper volume, and beeper frequency.
Enable/Disable Scanning	Touch Enable scanning or Disable scanning to enable, or disable the feature.

Settings

To display the *Settings* screen touch *Settings* from the *Home* screen (*Figure 7-1*).

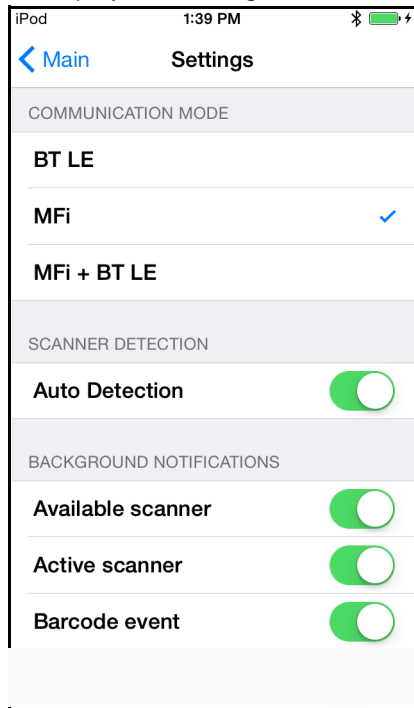

Figure 7-6 Settings Screen

Table 7-4 Settings Screen

Field	Description
COMMUNICATION MODE	
BT LE	Select to interact with scanners operating in BT LE mode.
MFi	Select to interact with scanners operating in BT MFi.
MFi + BT LE	Select to interact with scanners operating in BT MFi and LE modes. Note: MFi + BT LE is not supported by the RFD8500.
SCANNER DETECTION	
Auto Detection	Use the switch control to enable/disable automatic detection of appearance, and disappearance of available scanners.

Table 7-4 Settings Screen (Continued)

Field	Description
BACKGROUND NOTIFICATION	
Available Scanner	Use the switch control to enable/disable the <i>Device Arrival</i> , and <i>Device Disappeared</i> background notifications.
Active Scanner	Use the switch control to enable/disable the <i>Session Established</i> , and <i>Session Terminated</i> background notifications.
Barcode Event	Use the switch control to enable/disable the <i>Barcode event</i> background notification.

Configuration (Not Supported by the RFD8500)

✓ **NOTE** Scanner configurations via this screen are supported by various Zebra scanners however, the RFD8500 does not support configuration by reading bar codes that this screen can display.

To display the *Scanner Configurations* screen touch *Configuration* from the *Home* screen ([Figure 7-1](#)).

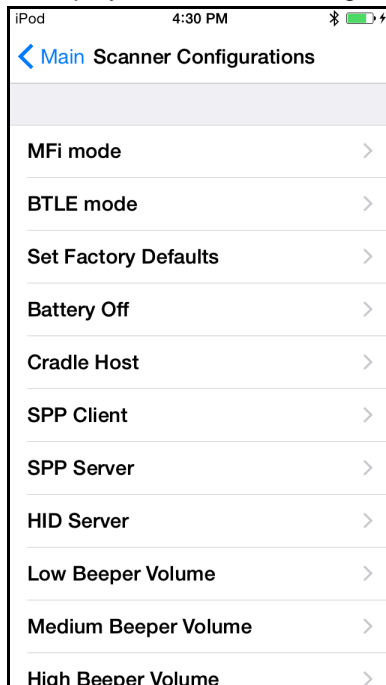
**Figure 7-7** Scanner Configurations Screen

Selecting an option from this screen displays a bar code to scan that configures the scanner.

About

To display the *About* screen touch *About* from the *Home* screen ([Figure 7-1](#)).



Figure 7-8 *About Screen*

This screen displays version and copyright information.

Chapter 8 123SCAN

Introduction

123Scan is an easy-to-use, PC-based software tool that enables the quick and easy setup of Zebra scanners, and the RFD8500 reader.

123Scan uses a wizard tool to guide users through a streamlined set up process. Once parameters are set, the values are saved to a configuration file that can be distributed via e-mail, electronically downloaded via a USB cable. 123Scan can generate multiple reports that can be easily re-branded using Microsoft Word or Access. Report options include programmed parameters, and asset tracking information.

Additionally, 123Scan can upgrade RFD8500 firmware, automatically check online to enable support for newly released products, and stage scanners simultaneously via USB hub(s).

✓ **NOTE** After you load updated configurations to the RFD8500 device via 123Scan, you must reboot the RFD8500 device in order to complete the configuration process. The RFD8500 automatically reboots if 123Scan is closed after the configuration upload.

If the RFD8500 was paired with the PC or mobile device before a firmware update, it might be necessary to un-pair, then pair again.

Communication with 123Scan

To communicate with the 123Scan program which runs on a host computer running a Windows XP SP2, Windows 7, and Windows 8 operating system, use a USB cable to connect the device to the host computer.

123Scan Requirements

- Host computer with Windows.
 - USB cable.
 - RFD8500.
 - Plug-ins:
 - Configuring RFD8500 models without a built-in imaging scan engine requires only the RFD8500 plug-in.
 - Configuring RFD8500 models with a built-in imaging scan engine requires two plug-ins to create two configuration files - one configuration file for the RFD8500, and a second configuration file for the iPL3307 (imager scan engine).
 - The RFD8500 plug-in is capable of configuration/firmware updates for both RFD8500 models (with and without an imaging scan engine).
- ✓ **NOTE** The RFD8500 plug-in does not support configuring/updating firmware for the iPL3307 (imaging scan engine).
- The iPL3307 plug-in is used for configuration/firmware updates for the integrated PL3307 imaging scan engine.

For more information on 123Scan, go to: <http://www.zebra.com/123Scan>.

For a 1 minute tour of 123Scan, go to: <http://www.zebra.com/ScannerHowToVideos>.

To download 123Scan software and access the Help file integrated in the utility, go to: www.zebra.com/scannersoftware.

Scanner SDK, Other Software Tools, and Videos

Tackle all your scanner programming needs with our diversified set of software tools. Whether you need to simply stage a device, or develop a fully featured application with image and data capture as well as asset management, these tools help you every step of the way. To download any of the free tools listed below, go to: www.zebra.com/scannersoftware.

- 123Scan Configuration Utility
- Scanner SDK for Windows
- Scanner SDK for iOS
- Scanner SDK for Android
- How-to-Videos
- Virtual Com Port Driver
- Scanner User Documentation.

Appendix A TROUBLESHOOTING, TECHNICAL SPECIFICATIONS and MAINTENANCE

Introduction

This chapter includes instructions on cleaning and maintenance, troubleshooting solutions for potential problems, and the web address for technical specifications.

Troubleshooting

✓ **NOTE** Always ensure the battery cover and battery are properly installed.

Table A-1 *Troubleshooting*

Problem	Possible Causes	Possible Solutions
Imager comes on, but scanner does not decode the bar code.	Reader is not programmed for the correct bar code type.	Ensure the scanner is programmed to read the type of bar code being scanned.
	Bar code symbol is unreadable.	Check the symbol to ensure it is not defaced. Try scanning test bar codes of the same bar code type.
	Bar code is out of range of the scanner.	Move scanner closer to or further from bar code.
Amber power LED turns on, or red power LED blinks.	Battery is low.	Charge the battery. See Charging the Battery in the Reader on page 1-10 .
Reader does not fully charge.	Attempt to charge on a non-powered USB hub.	Connect the scanner to a powered USB power adapter (5V, 1.2A max).
Bluetooth LED turns off.	Reader is out of range of the Bluetooth host.	Move closer to the host and press any key to re-pair with the host.

Table A-1 Troubleshooting (Continued)

Problem	Possible Causes	Possible Solutions
Unable to pair the RFD8500 with the mobile device.	Bluetooth is off on the mobile device.	Turn on Bluetooth on the mobile device.
	Bluetooth on the RFD8500 is off.	Turn on Bluetooth on the RFD8500.
Unable to discover the RFD8500.	RFD8500 is turned off.	Turn on the RFD8500.
	RFD8500 is not in discover mode.	Press the Bluetooth button for 1 second to put the RFD8500 into discover mode.
No bar code, or RFID data displays in the application on the mobile computer when the RFD8500 starts reading.	Batch Mode is enabled.	In the Batch Mode setting, set RFD8500 to <i>Auto</i> or <i>Disable</i> from the Tag Reporting screen.

Technical Specifications

For the latest technical specification information for the RFD8500, visit: <http://www.zebra.com/RFD8500>.

Cleaning



CAUTION Always wear eye protection.

Read warning label on compressed air and alcohol product before using.

If you have to use any other solution for medical reasons please contact Motorola for more information.



WARNING! Avoid exposing this product to contact with hot oil or other flammable liquids. If such exposure occurs, unplug the device and clean the product immediately in accordance with these guidelines.

Approved Cleanser Active Ingredients

100% of the active ingredients in any cleaner must consist of one or some combination of the following: isopropyl alcohol, bleach/sodium hypochlorite, hydrogen peroxide or mild dish soap.

Harmful Ingredients

The following chemicals are known to damage the plastics on the RFD8500 and mobile computers and should not come in contact with the device: ammonia solutions, compounds of amines or

ammonia; acetone; ketones; ethers; aromatic and chlorinated hydrocarbons; aqueous or alcoholic alkaline solutions; ethanolamine; toluene; trichloroethylene; benzene; carbolic acid and TB-lysoform.

Cleaning Instructions

Do not apply liquid directly to the RFD8500 and mobile computers. Dampen a soft cloth or use pre-moistened wipes. Do not wrap the device in the cloth or wipe, but gently wipe the unit. Be careful not to let liquid pool around the display window or other places. Allow the unit to air dry before use.



IMPORTANT Do not clean the device or expose it to rain or moisture when the battery cover is removed. Without the battery cover, the device is not water/dust sealed.

Special Cleaning Notes

Many vinyl gloves contain phthalate additives, which are often not recommended for medical use and are known to be harmful to the housing of the RFD8500 and mobile computers. The RFD8500 should not be handled while wearing vinyl gloves containing phthalates, or before hands are washed to remove contaminant residue after gloves are removed. If products containing any of the harmful ingredients listed above are used prior to handling the RFD8500, such as hand sanitizer that contain ethanalamine, hands must be completely dry before handling the RFD8500 to prevent damage to the plastics.

Materials Required

- Alcohol wipes
- Lens tissue
- Cotton tipped applicators
- Isopropyl alcohol
- Can of compressed air with a tube.

Cleaning Charge Connectors

To clean the connectors on a cradle:

1. Remove the DC power cable from the cradle.
2. Dip the cotton portion of the cotton tipped applicator in isopropyl alcohol.
3. Rub the cotton portion of the cotton tipped applicator along the pins of the connector. Slowly move the applicator back-and-forth from one side of the connector to the other. Do not let any cotton residue on the connector.
4. All sides of the connector should also be rubbed with the cotton tipped applicator.
5. Spray compressed air in the connector area by pointing the tube/nozzle about ½ inch away from the surface.



CAUTION Do not point nozzle at yourself and others, ensure the nozzle or tube is pointed away from your face.

6. Ensure that there is no lint left by the cotton tipped applicator, remove lint if found.
7. If grease and other dirt can be found on other areas of the cradle, use lint free cloth and alcohol to remove.
8. Allow at least 10 to 30 minutes (depending on ambient temperature and humidity) for the alcohol to air dry before applying power to cradle.

If the temperature is low and humidity is high, longer drying time is required. Warm temperature and dry humidity requires less drying time.

Cleaning Frequency

The cleaning frequency is up to the customer's discretion due to the varied environments in which the mobile devices are used. They may be cleaned as frequently as required. However when used in dirty environments it may be advisable to periodically clean the scanner exit window to ensure optimum scanning performance.

Maintenance

For trouble-free service, observe the tips that follow when using the device.

RFD8500

- Although the device is water and dust resistant, do not expose it to rain or moisture for an extended period of time. In general, treat the device as a pocket calculator or other small electronic instrument.
- Do not clean the device or expose it to rain or moisture when the battery is removed. Without the battery, the device is not water/dust sealed.
- Do not drop the device or subject it to strong impact.
- Protect the device from temperature extremes. Do not leave it on the dashboard of a car on a hot day, and keep it away from heat sources.
- Do not store or use the device in any location that is extremely dusty, damp, or wet.
- Do not use window cleaning solution. Use a soft cloth dampened with a 50/50 solution of isopropyl alcohol and water. See [Cleaning on page A-2](#).
- Do not allow the solution to form a pool of liquid anywhere on the screen or device.
- Do not use a large amount of solution to cause the device to remain wet.

Battery



WARNING! Do not store the device with the battery installed. Doing so long term may cause irreversible harm to the battery. Always store the battery removed from the device. If a battery is installed during long term storage, it may discharge to point at which it cannot be recovered.

Even when stored separately from device it is important to follow industry standard guidelines. When batteries are stored over a year, battery cell manufacturers advise that some irreversible deterioration in overall battery quality may occur. To minimize this loss, they recommend storing batteries half charged in a dry, cool place between 41° and 77°F (5° and 25°C), the cooler the better. Batteries should be charged to half capacity at least once a year. In order to charge a battery to half capacity, take a fully discharged battery and charge it for two hours. If an electrolyte leakage is observed, avoid any contact with the affected area and properly dispose of the battery.

INDEX

A

- accessories
 - adapter mount. MC40 ii-x
 - adapter mount. TC55 ii-x
 - battery ii-x
 - cables ii-x
 - charging ii-x
 - dual battery charger ii-xi
 - host adapters ii-x
 - quad lock, iPod touch ii-x
 - quad lock, smartphones ii-x
- adapters, host ii-x
- adaptive frequency hopping 2-4
- aiming 2-8
- antenna housing 1-3
- applications
 - download 1-12
 - rfid for ios
 - about screen 4-23
 - access control screen 4-21
 - antenna screen 4-11
 - application screen 4-10
 - battery screen 4-16
 - beeper screen 4-18
 - home screen 4-3
 - inventory screen 4-5
 - locate reader screen 4-20
 - locate tag screen 4-7
 - power optimization screen 4-17
 - pre filters screen 4-22
 - rapid read screen 4-4
 - readers list screen 4-9
 - regulatory screen 4-15
 - save configuration screen 4-19
 - settings screen 4-8
 - singulation control screen 4-12
 - start/stop triggers screen 4-13
 - tag reporting screen 4-14
- rfid for windows
 - about screen 5-22
 - access control screen 5-19
 - antenna screen 5-10
 - application screen 5-9
 - battery screen 5-15
 - beeper screen 5-17
 - home screen 5-2
 - inventory screen 5-4
 - locate tag screen 5-6
 - power management screen 5-16
 - pre filters screen 5-20
 - rapid read screen 5-3
 - readers list screen 5-8
 - regulatory screen 5-14
 - save configuration screen 5-18
 - settings screen 5-7
 - singulation control screen 5-11
 - start/stop triggers screen 5-12
 - tag reporting screen 5-13
- scanner for android
 - about screen 6-11
 - active scanners screen 6-6
 - config screen (not supported) 6-10
 - home screen 6-2
 - scanners screen 6-3
 - settings screen 6-9
- scanner for ios
 - about screen 7-9
 - active scanners screen 7-5
 - config screen (not supported) 7-8
 - home screen 7-2
 - scanners screen 7-3
 - settings screen 7-7
- using rfid mobile app for ios 4-1

- using rfid mobile app for windows 5-1
- using scanner control for ios 7-2
- using scanner for android 6-2

B

- bar code scanning 2-8
- bar code/rfid indicator 1-3, 6-7, 7-5
- batch mode 2-9, A-2
- battery
 - charging 1-10
 - door accessories ii-x
 - dual charger ii-xi
 - installing 1-4
 - management 1-11
 - notification 1-11
 - optimization 1-11
 - removing 1-7
- battery cover release buttons 1-3
- beeper 1-3
 - indicators
 - conditions 2-2
- bluetooth
 - adaptive frequency hopping 2-4
 - bluetooth button/indicator 1-3
 - connections 2-3
 - disconnect 2-2
 - enable 2-1
 - out of range A-1
 - pairing 2-5
 - security 2-4
- buttons
 - battery cover release 1-3
 - mode 1-3, 2-1
 - power 1-3

C

- charging
 - accessories 1-10
 - contacts 1-3
 - temperature 1-11
- charging battery 1-10
- configurations
 - RFD8500 with imager ii-x
 - RFD8500 without imager ii-x

D

- data transfer 2-9
- downloading software
 - android application 1-12
 - ios application 1-12
- dpo 4-4, 4-6, 4-7, 4-17, 5-3, 5-6, 5-16

F

- features
 - buttons, indicators, parts 1-2
 - descriptions 1-3
 - led and beeper indicators 2-2
 - using buttons and scan trigger 2-1

I

- installing battery 1-4

L

- lanyard 1-9
- led indicators
 - bar code/rfid 1-3, 6-7, 7-5
 - bluetooth 1-3
 - conditions 2-2
 - mode 1-3, 2-1
 - power 1-3

M

- maintenance A-4
- mode button/indicator 1-3, 2-1
- mounting mobile device 1-8

P

- pairing
 - android device 2-5
 - ios device 2-6
 - windows 10 device 2-6
- power button 1-3
- power indicator 1-3
- power management 4-4, 4-6, 4-7, 4-17, 5-3, 5-6, 5-16
- powering on/off 2-1

R

- reading tags 2-8
- removing battery 1-7
- reset
 - soft 2-2
- rfid antenna 1-3

S

- scan trigger 1-3
- scanning 2-8
 - aiming 2-8
- set up 1-4

soft boot	2-2
soft reset	1-3
software	
installing	1-12
requirements	1-12

T

tag reading	2-8
transferring data	
in batch mode	2-9
via Bluetooth	2-9
via USB	2-9
troubleshooting	A-1

U

USB port/cover	1-3
using	
rfid mobile for ios	4-1
rfid mobile for windows	5-1
scanner control for ios	7-2
scanner for android	6-2



Zebra Technologies Corporation
Lincolnshire, IL U.S.A.
<http://www.zebra.com>

ZEBRA and the stylized Zebra head are trademarks of Zebra Technologies Corporation, registered in many jurisdictions worldwide. All other trademarks are the property of their respective owners. ©2019 Zebra Technologies Corporation and/or its affiliates. All rights reserved.

