

USER MANUAL

AVX-HDMI2-HDB

HDMI 2.0 EXTENDER

24/7 TECHNICAL SUPPORT AT 1.877.877.2269 OR VISIT BLACKBOX.COM

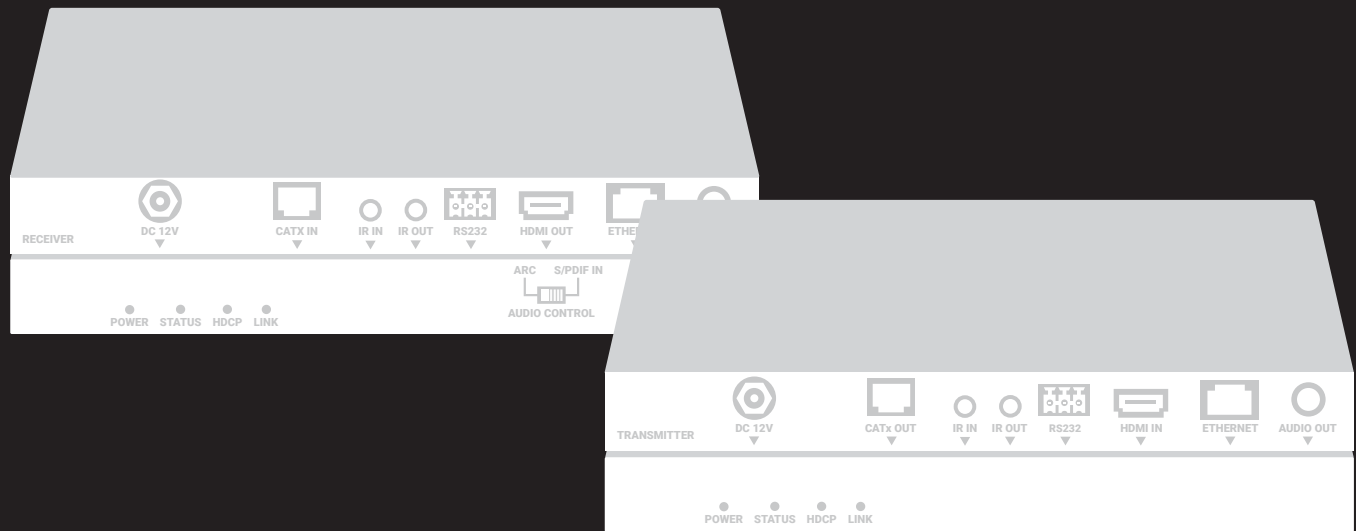

TABLE OF CONTENTS

IMPORTANT SAFETY INSTRUCTIONS	3
1. SPECIFICATIONS	4
2. OVERVIEW	6
2.1 Introduction.....	6
2.2 Features	6
2.3 What's Included	7
2.4 Hardware Description	8
2.4.1 Transmitter	8
2.4.2 Receiver.....	10
3. CONNECTIONS AND INSTALLATION	12
Installation Steps.....	12
4. OPERATING WITH IR	15
4.1 IR Control.....	15
4.2 Control the Display	15
4.3 Control the Source	16
5. OPERATING WITH RS-232	17
5.1 RS-232 Pinout	17
5.2 RS-232 Passthrough.....	18
6. TROUBLESHOOTING	19
6.1 Troubleshooting Steps.....	19
6.2 Contacting Black Box.....	19
APPENDIX A. REGULATORY INFORMATION	20
A.1 FCC Statement	20
A.2 NOM Statement	21
APPENDIX B. DISCLAIMER/TRADEMARKS	22
B.1 Disclaimer	22
B.2 Trademarks Used in this Manual	22



IMPORTANT SAFETY INSTRUCTIONS

1. Do not expose this apparatus to rain, moisture, dripping or splashing liquids. Do not place any objects filled with liquids, such as vases, on the apparatus.
2. Do not install or place this unit in a bookcase, built-in cabinet or in another confined space. Make sure the unit is well ventilated.
3. To prevent risk of electric shock or fire hazard due to overheating, do not obstruct the unit's ventilation openings with newspapers, tablecloths, curtains, and similar items.
4. Do not install near any heat sources such as radiators, heat registers, stoves, or other apparatus (including amplifiers) that produce heat.
5. Do not place sources of open flames, such as lighted candles, on the unit.
6. Clean this apparatus only with a dry cloth.
7. Unplug this apparatus during lightning storms or when unused for long periods of time.
8. Do not walk on or pinch the power cord, particularly at plugs.
9. Only use attachments/accessories specified by the manufacturer.
10. Refer all servicing to qualified service personnel.



CHAPTER 1: SPECIFICATIONS

TABLE 1-1. SPECIFICATIONS

SPECIFICATION	DESCRIPTION
Transmitter	
Video Input	(1) HDMI female
Input Signal Type	HDMI with 4K
Input/Output Resolution Support	800 x 600, 1024 x 768, 1280 x 720, 1280 x 768, 1280 x 800, 1280 x 960, 1280 x 1024, 1360 x 768, 1366 x 768, 1440 x 900, 1600 x 900, 1600 x 1200, 1680 x 1050, 1920 x 1080, 1920 x 1200, 2560 x 1440, 2560 x 1600, 3840 x 2160P, 4096 x 2160P
Maximum Data Rate	18 Gbps
Input Video Level	0.5 – 1.0 V p-p
Input DDC Signal	5 V p-p
Maximum Pixel Clock	594 MHz
Output	(1) CATx
Output Signal Type	CATx
Video Impedance	100 ohms
Power Consumption (Maximum)	Receiver powered by transmitter: 18.6 W (1080p) 21.6 W (4K @ 60 Hz YUV 4:4:4) Transmitter and Receiver powered separately: 11.6 W (1080p) 18.96 W (4K @ 60 Hz YUV 4:4:4)
Receiver	
Video Input	(1) CATx
Input Signal Type	CATx
Output Signal Type	HDMI 2.0 and HDCP 2.2
Input/Output Resolution Support	800 x 600, 1024 x 768, 1280 x 720, 1280 x 768, 1280 x 800, 1280 x 960, 1280 x 1024, 1360 x 768, 1366 x 768, 1440 x 900, 1600 x 900, 1600 x 1200, 1680 x 1050, 1920 x 1080, 1920 x 1200, 2560 x 1440, 2560 x 1600, 3840 x 2160P, 4096 x 2160P
Maximum Data Rate	18 Gbps
Input Video Level	0.5 – 1.0 V p-p
Input DDC Signal	5 V p-p
Maximum Pixel Clock	584 MHz
Output	(1) HDMI
Output Signal Type	HDMI with 4K
Video Impedance	100 ohms
Power Consumption (Maximum)	Transmitter and Receiver powered separately: 7.44 W (1080p) 7.2 W (4K @ 60 Hz YUV 4:4:4)



CHAPTER 1: SPECIFICATIONS

TABLE 1-1 (CONTINUED). SPECIFICATIONS

SPECIFICATION	DESCRIPTION
General	
ESD Protection	Human-Body Model: ±8 kV (air-gap discharge)/±4 kV (contact discharge)
Surge Protection	Voltage: ±1 kV
Electrical Fast Transient/Burst	Data communication cord: 1 kV Power cord: 2 kV
Approvals	CE, FCC, IC, RCM, and VCCI
Power	
Power Supply	Each unit: (1) External 12 VDC, 3 A
Environmental	
Operating Temperature	32 to 113° F (0 to 45° C)
Storage Temperature	-4 to +158° F (-20 to +70° C)
Humidity	10 to 90%, noncondensing
Mechanical	
Dimensions	Each unit: 0.8" H x 6.8" W x 3.7" D (2.1 x 17.3 x 9.5 cm)
Weight	Each unit: 0.9 lb. (0.4 kg)

TABLE 1-2. CABLE SPECIFICATIONS

CABLE TYPE	RANGE	SUPPORTED VIDEO
CAT5e/6	328 ft. (100 m)	1080p @ 60 Hz, 36 bpp
	230 ft. (70 m)	1080p @ 60 Hz, 48 bpp
CAT6a/7	328 ft. (100 m)	1080p @ 60 Hz 3D 4K @ 60 Hz YUV 4:4:4

CHAPTER 2: OVERVIEW

2.1 INTRODUCTION

The HDMI 2.0 CATx Extender supports 4K @ 60 4:4:4 resolution and complies with HDR and HDCP 2.2 standards. It distributes uncompressed UHD video, audio, power, and IR together up to 328 feet (100 meters) over a single CATx cable.

The extender supports Dolby and DTS HD audio, bi-directional IR control, in a low-profile box. You can configure the ARC channel feed for a TV (with ARC support) or an auxiliary S/PDIF Input port via an audio output DIP switch on the receiver.

The extender uses proprietary one-way PoH technology to power the receiver from the transmitter.

LEDs show power and signal status for established connections between devices.

2.2 FEATURES

- ◆ 4K/UHD capability @ 60 Hz with 4:4:4 Chroma sampling, plus support for HDR formats
- ◆ HDCP 2.2 compliant
- ◆ Supports HD signal transmission up to 100 meters (1080p) and 70 meters (4K @ 60 Hz YUV 4:4:4) via a single CAT5e/6 cable
- ◆ Supports HD signal transmission up to 100 meters (1080p) and 100 meters (4K @ 60 Hz YUV 4:4:4) via a single CAT6a/7 cable
- ◆ Visually Lossless Compression enables 4K @ 60 HDR extension over CATx
- ◆ Receiver to transmitter audio return via ARC or digital coax pathway
- ◆ Extends RS232, IR and Ethernet control signals
- ◆ Standard One way PoH (Transmitter power to receiver)
- ◆ Automatic EDID management
- ◆ Visual LED indication



CHAPTER 2: OVERVIEW

2.3 WHAT'S INCLUDED

Your package should include the following items. If anything is missing or damaged, contact Black Box Technical Support at 877-877-2269 or info@blackbox.com

AVX-HDMI2-HDB includes:

- ◆ (1) Transmitter
- ◆ (1) Receiver
- ◆ (1) Power adapter (12 VDC, 3 A)
- ◆ (2) Phoenix male connectors (3.5-mm, 3-pin)
- ◆ (1) IR emitter cable
- ◆ (1) IR broadband receiver cable (30 kHz – 50 KHz)
- ◆ (4) Mounting brackets

CHAPTER 2: OVERVIEW

2.4 HARDWARE DESCRIPTION

The HDMI 2.0 Extender – CATx, 4K60, Audio, IR consists of a Transmitter unit and a Receiver unit.

2.4.1 TRANSMITTER

Figures 2-1 and 2-2 show the front, top and back panels of the transmitter. Table 2-1 describes its components.



FIGURE 2-1. TRANSMITTER FRONT PANEL

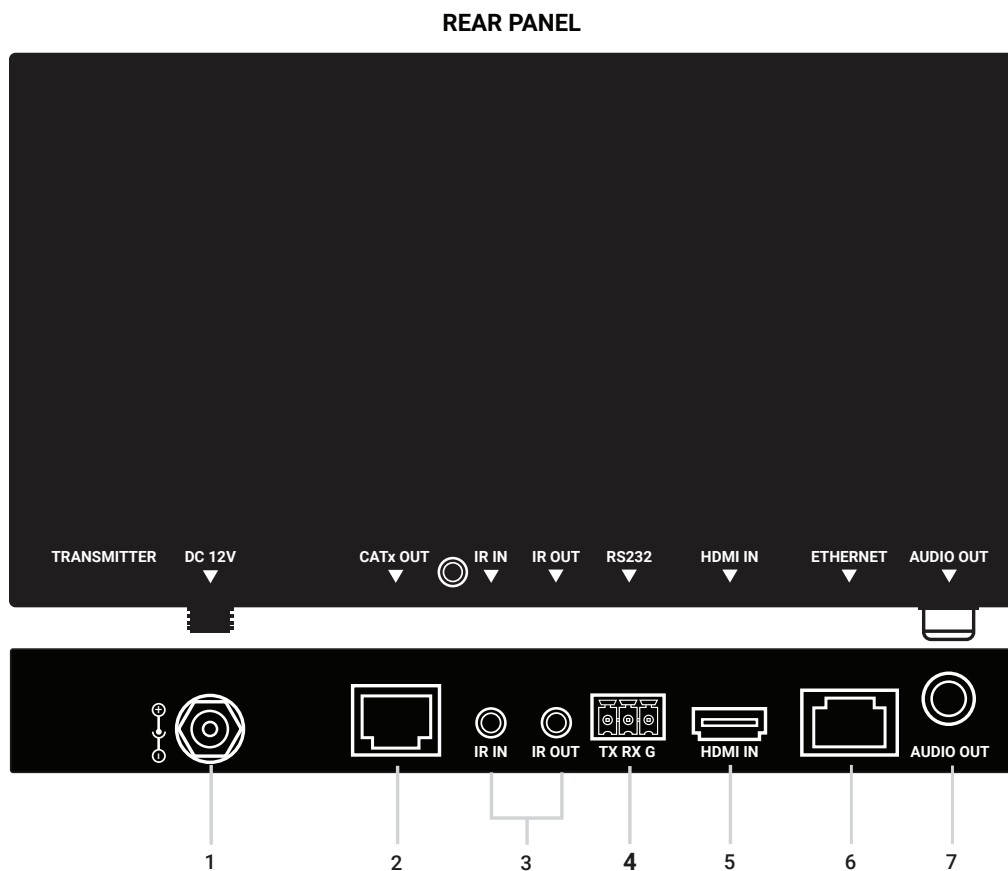

FIGURE 2-2. TRANSMITTER TOP AND BACK PANEL

CHAPTER 2: OVERVIEW**TABLE 2-1. TRANSMITTER COMPONENTS**

NUMBER IN FIGURE 2-1	COMPONENT	DESCRIPTION
1	Power LED	ON: The transmitter is powered on. OFF: The transmitter is powered off.
2	Status LED	Flashing: The transmitter is working properly. OFF: The transmitter is not working properly.
3	HDCP LED	ON: HDCP video is being transmitted. Flashing: Non-HDCP video is being transmitted. OFF: No HDMI signal.
4	Link LED	ON: CATx link is normal OFF: No CATx link
NUMBER IN FIGURE 2-2	COMPONENT	DESCRIPTION
1	Power connector	Links to 12-VDC power input
2	CATx OUT	Connects to CATx IN port of receiver
3	IR IN	Connects to IR receiver
3	IR OUT	Connects to IR emitter
4	RS-232	Connects to control system for RS-232 passthrough
5	HDMI IN connector	Connects to an HDMI source
6	RJ-45 Ethernet connector	Connects to internet with computer while the receiver is connected to the internet via a router
7	AUDIO OUT	Connects to an audio system such as an AV receiver

CHAPTER 2: OVERVIEW

2.4.2 RECEIVER

Figures 2-3 and 2-4 show the front and back panels of the receiver. Table 2-2 describes its components.

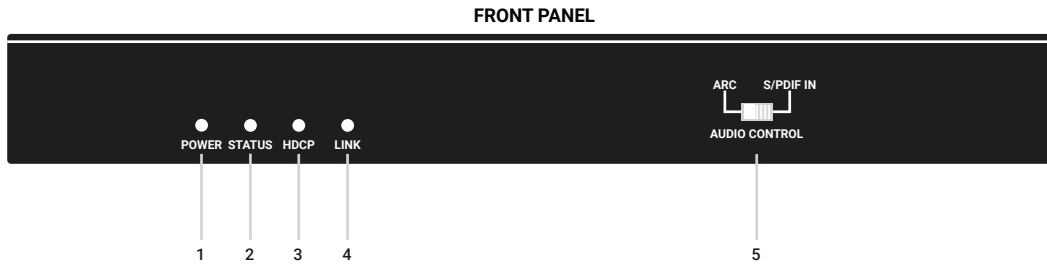

FIGURE 2-3. RECEIVER FRONT PANEL

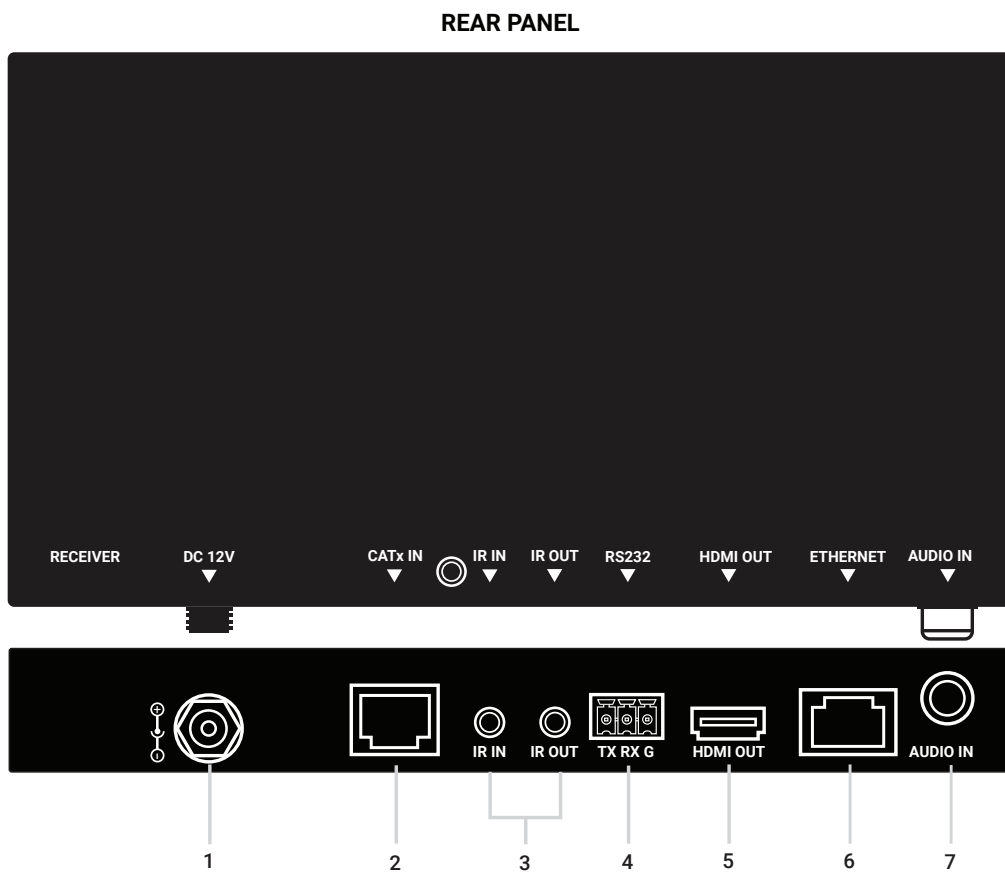

FIGURE 2-4. RECEIVER BACK PANEL

CHAPTER 2: OVERVIEW**TABLE 2-2. RECEIVER COMPONENTS**

NUMBER IN FIGURE 2-3	COMPONENT	DESCRIPTION
1	Power LED	ON: The receiver is powered on. OFF: The receiver is powered off.
2	Status LED	Flashing: The receiver is working properly. OFF: The receiver is not working properly.
3	HDCP LED	ON: HDCP video is being transmitted. Flashing: Non-HDCP video is being transmitted. OFF: No HDMI signal.
4	Link LED	ON: CATx link is normal. OFF: No CATx link.
5	Audio Control	ARC: Configure ARC channel feed by TV S/PDIF IN: Configure auxiliary S/PDIF input
NUMBER IN FIGURE 2-4	COMPONENT	DESCRIPTION
1	Power connector	Links to 12-VDC power input
2	CATx IN	Connects to an CATx OUT port of transmitter
3	IR IN	Connects to IR receiver
3	IR OUT	Connects to IR emitter
4	RS-232	Connects to a control system for RS-232 passthrough
5	HDMI OUT connector	Connects to an HDMI display
6	RJ-45 Ethernet connector	Connects to internet with computer while the transmitter is connected to the internet via a router
7	AUDIO OUT	Connects to an audio system on S/PDIF IN mode

CHAPTER 3: CONNECTIONS AND INSTALLATION

INSTALLATION STEPS

1. Using quality HDMI cables, connect an HDMI source (such as Blu-ray, games console, satellite/cable TV, media server etc.) to the HDMI IN port of the transmitter.
2. Connect an audio system such as an AV receiver to the AUDIO OUT port of the transmitter.
3. Connect a good quality, well-terminated CATx cable between the CATx OUT port of the transmitter to the CATx IN port of the receiver.
4. Connect the HDMI display device such as a TV to the HDMI OUT port of the receiver.
5. For two-way IR control of connected sources and displays from either location, first, connect IR Emitters to the IR OUT ports of the transmitter and receiver, and then insert IR Receivers into the IR IN ports of the transmitter and receiver.
6. For the DIP switch of the audio output of the receiver:
 - ♦ When you configure the ARC channel feed by TV, switch it to ARC mode. The TV should be supported and ARC and CEC should be open. See Figure 3-1.
 - ♦ When you configure the auxiliary S/PDIF input, switch it to S/PDIF mode and connect an audio system to the AUDIO IN port of the receiver. See Figure 3-2.
7. Connect the included 12-V power supply to the transmitter. The PoE function carries power along the length of cable to power the receiver.

Check that Power, Status, and HDCP and Link lights are illuminated on both units to indicate successful connection, with a lit HDCP light illustrating the presence of encryption within the signal. Power and Link are static lights. Status should be blinking.



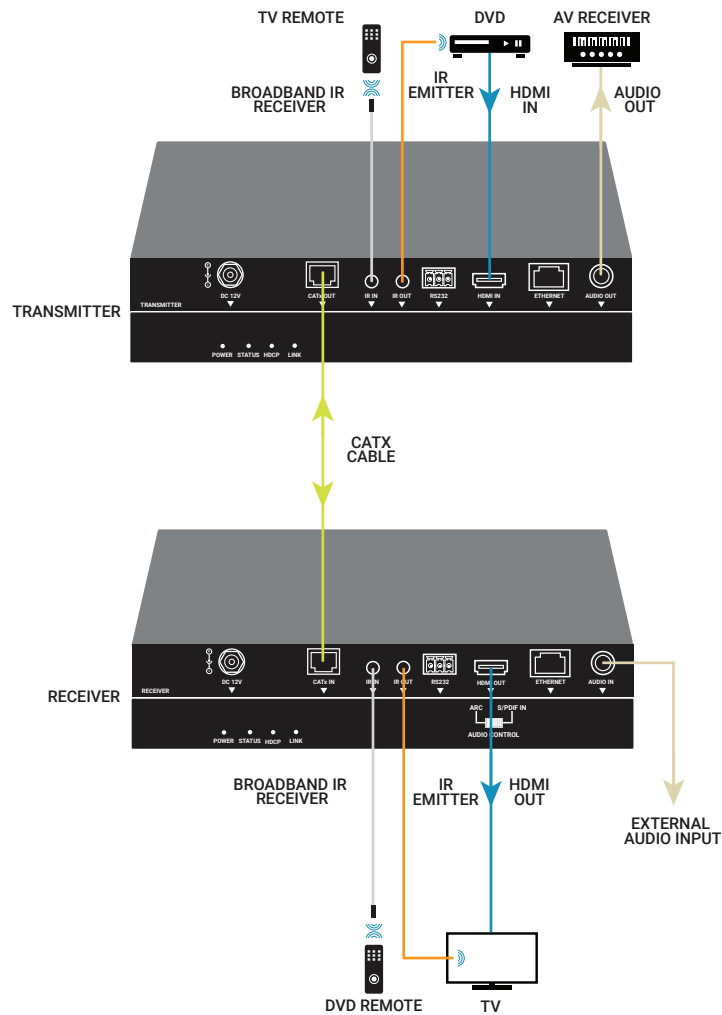

FIGURE 3-1. CONFIGURE ARC CHANNEL

CHAPTER 3: CONNECTIONS AND INSTALLATION

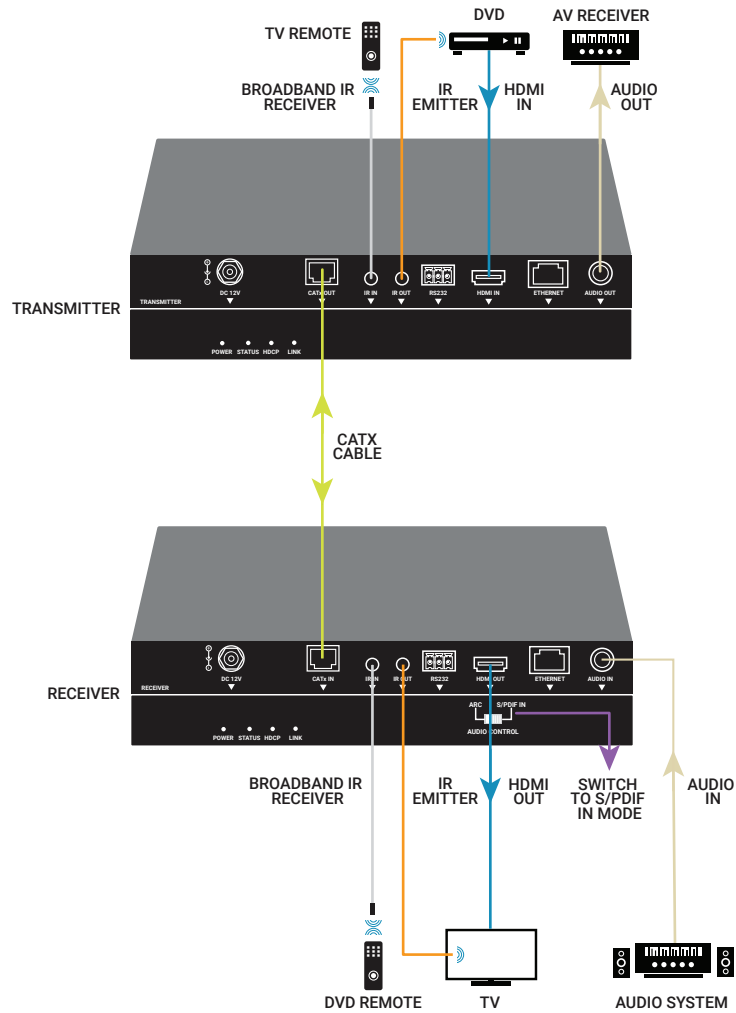

FIGURE 3-2. CONFIGURE S/PDIF

CHAPTER 4: OPERATING WITH IR

4.1 IR CONTROL

The IR passthrough function allows you to control the source from the display location or control the display from the source location.

4.2 CONTROL THE DISPLAY

In this case, IR IN port on the transmitter is connected to a broadband IR receiver and the IR OUT port on the receiver is connected to an IR emitter. You can control the TV from the DVD location with the TV remote.

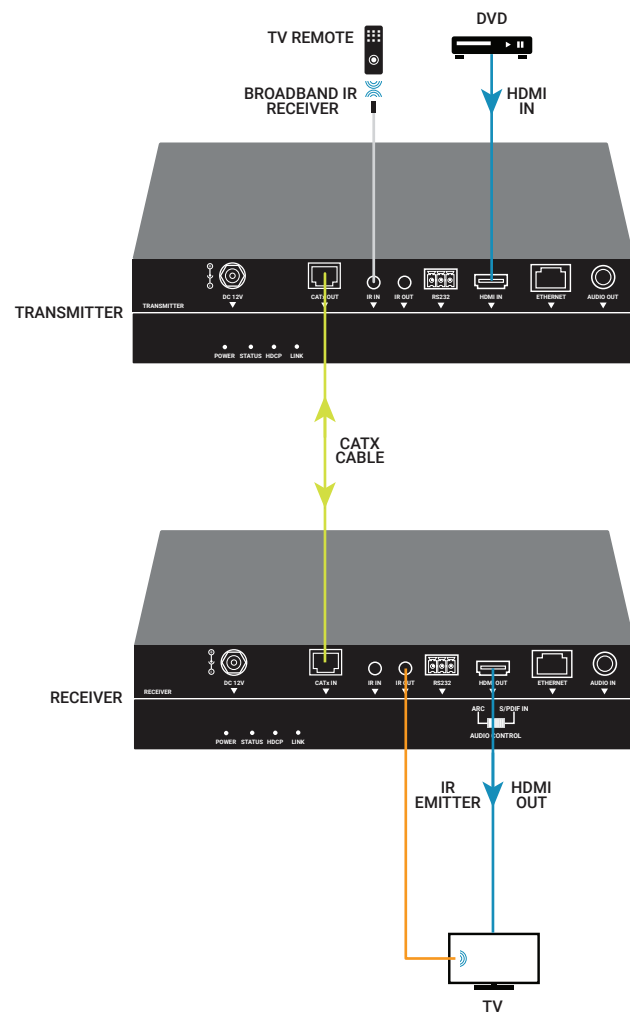

FIGURE 4-1. CONTROL THE DISPLAY

CHAPTER 4: OPERATING WITH IR

4.2 CONTROL THE SOURCE

In this case, the IR OUT port of the transmitter is connected to an IR emitter and the IR IN port of the receiver is connected to a broadband IR receiver. You can control the DVD player from the TV location with the DVD remote.

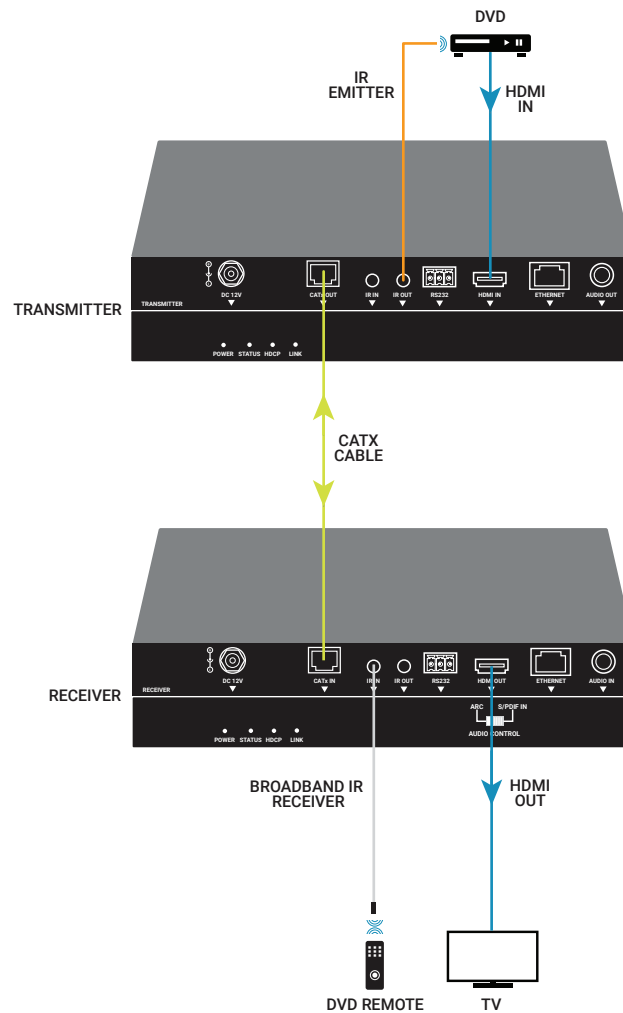

FIGURE 4-2. CONTROL THE SOURCE

CHAPTER 5: OPERATING WITH RS-232

5.1 RS-232 PINOUT

The following figure shows the RS-232 pinout. Please connect with the Phoenix connectors provided.

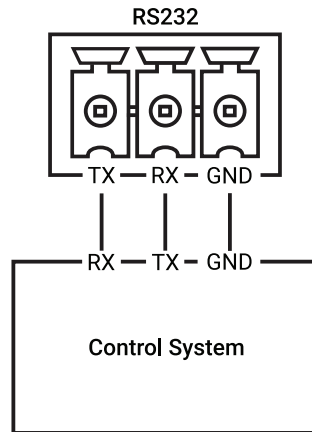

FIGURE 5-1. RS-232 PINOUT

CHAPTER 5: OPERATING WITH RS-232

5.2 RS-232 PASSTHROUGH

According to the bi-directional RS-232 pass through function, you can use two RS-232 control systems for serial communication by connecting to the devices via serial cables to control the source device or the display.

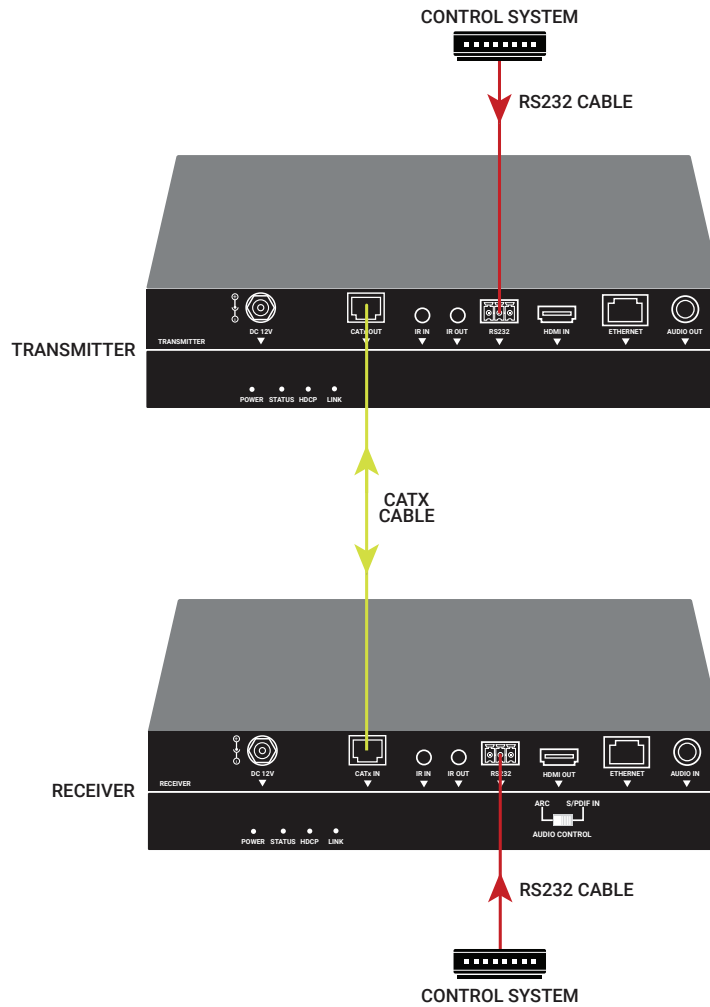

FIGURE 5-2. RS-232 PASSTHROUGH

CHAPTER 6: TROUBLESHOOTING

6.1 TROUBLESHOOTING STEPS

Follow these steps to troubleshoot your extender:

1. Power: Make sure all devices are powered on (the sources, extender and display).
2. Indicator: Make sure LED indicators of the extender is normal according to user manual.
3. Devices: Make sure a picture can be shown normally when connecting source to display devices directly.
4. Cable: Plug in and out an HDMI/CATx cable or try another HDMI/CATx cable. Make sure the specific cable length is within the transmission range in the user manual Specification section. CAT5e/6/6a/7 cable is recommended, do not use CAT5 cable. Make sure the two connectors of one CATx cable are the same standard (EIA/TIA 568B).
5. Compatibility: Test other source and display devices to determine if it is a compatibility issue.

6.2 CONTACTING BLACK BOX

If you determine that your extender is malfunctioning, do not attempt to alter or repair the unit. It contains no user-serviceable parts. Contact Black Box Technical Support at 877-877-2269 or info@blackbox.com.

Before you do, make a record of the history of the problem. We will be able to provide more efficient and accurate assistance if you have a complete description, including:

- ♦ the nature and duration of the problem.
- ♦ when the problem occurs.
- ♦ the components involved in the problem.
- ♦ any particular application that, when used, appears to create the problem or make it worse.

APPENDIX A: REGULATORY COMPLIANCE

A.1 FCC STATEMENT

This equipment generates, uses, and can radiate radio-frequency energy, and if not installed and used properly, that is, in strict accordance with the manufacturer's instructions, may cause interference to radio communication. It has been tested and found to comply with the limits for a Class A computing device in accordance with the specifications in Subpart B of Part 15 of FCC rules, which are designed to provide reasonable protection against such interference when the equipment is operated in a commercial environment. Operation of this equipment in a residential area is likely to cause interference, in which case the user at his own expense will be required to take whatever measures may be necessary to correct the interference.

Changes or modifications not expressly approved by the party responsible for compliance could void the user's authority to operate the equipment.

This digital apparatus does not exceed the Class A limits for radio noise emission from digital apparatus set out in the Radio Interference Regulation of Industry Canada.

Le présent appareil numérique n'émet pas de bruits radioélectriques dépassant les limites applicables aux appareils numériques de classe A prescrites dans le Règlement sur le brouillage radioélectrique publié par Industrie Canada.



APPENDIX A: REGULATORY COMPLIANCE

A.2 NOM STATEMENT

1. Todas las instrucciones de seguridad y operación deberán ser leídas antes de que el aparato eléctrico sea operado.
2. Las instrucciones de seguridad y operación deberán ser guardadas para referencia futura.
3. Todas las advertencias en el aparato eléctrico y en sus instrucciones de operación deben ser respetadas.
4. Todas las instrucciones de operación y uso deben ser seguidas.
5. El aparato eléctrico no deberá ser usado cerca del agua—por ejemplo, cerca de la tina de baño, lavabo, sótano mojado o cerca de una alberca, etc.
6. El aparato eléctrico debe ser usado únicamente con carritos o pedestales que sean recomendados por el fabricante.
7. El aparato eléctrico debe ser montado a la pared o al techo sólo como sea recomendado por el fabricante.
8. Servicio—El usuario no debe intentar dar servicio al equipo eléctrico más allá a lo descrito en las instrucciones de operación. Todo otro servicio deberá ser referido a personal de servicio calificado.
9. El aparato eléctrico debe ser situado de tal manera que su posición no interfiera su uso. La colocación del aparato eléctrico sobre una cama, sofá, alfombra o superficie similar puede bloquea la ventilación, no se debe colocar en libreros o gabinetes que impidan el flujo de aire por los orificios de ventilación.
10. El equipo eléctrico deber ser situado fuera del alcance de fuentes de calor como radiadores, registros de calor, estufas u otros aparatos (incluyendo amplificadores) que producen calor.
11. El aparato eléctrico deberá ser conectado a una fuente de poder sólo del tipo descrito en el instructivo de operación, o como se indique en el aparato.
12. Precaución debe ser tomada de tal manera que la tierra física y la polarización del equipo no sea eliminada.
13. Los cables de la fuente de poder deben ser guiados de tal manera que no sean pisados ni pellizcados por objetos colocados sobre o contra ellos, poniendo particular atención a los contactos y receptáculos donde salen del aparato.
14. El equipo eléctrico debe ser limpiado únicamente de acuerdo a las recomendaciones del fabricante.
15. En caso de existir, una antena externa deberá ser localizada lejos de las líneas de energía.
16. El cable de corriente deberá ser desconectado del cuando el equipo no sea usado por un largo periodo de tiempo.
17. Cuidado debe ser tomado de tal manera que objetos líquidos no sean derramados sobre la cubierta u orificios de ventilación.
18. Servicio por personal calificado deberá ser provisto cuando:
 - A: El cable de poder o el contacto ha sido dañado; u
 - B: Objetos han caído o líquido ha sido derramado dentro del aparato; o
 - C: El aparato ha sido expuesto a la lluvia; o
 - D: El aparato parece no operar normalmente o muestra un cambio en su desempeño; o
 - E: El aparato ha sido tirado o su cubierta ha sido dañada.

APPENDIX B: DISCLAIMER/TRADEMARKS

B.1 DISCLAIMER

Black Box Corporation shall not be liable for damages of any kind, including, but not limited to, punitive, consequential or cost of cover damages, resulting from any errors in the product information or specifications set forth in this document and Black Box Corporation may revise this document at any time without notice.

B.2 TRADEMARKS USED IN THIS MANUAL

Black Box and the Black Box logo type and mark are registered trademarks of Black Box Corporation.

Any other trademarks mentioned in this manual are acknowledged to be the property of the trademark owners.



**NEED HELP?
LEAVE THE TECH TO US**

**LIVE 24/7
TECHNICAL
SUPPORT**

1.877.877.2269

