

DS-730N

User's Guide

Product Features

Scanner Basics

**Specifications of Originals and Placing
Originals**

Preparing to Scan over a Network

Basic Scanning

Maintenance

Solving Problems

Copyright

No part of this publication may be reproduced, stored in a retrieval system, or transmitted in any form or by any means, electronic, mechanical, photocopying, recording, or otherwise, without the prior written permission of Seiko Epson Corporation. No patent liability is assumed with respect to the use of the information contained herein. Neither is any liability assumed for damages resulting from the use of the information herein. The information contained herein is designed only for use with this Epson product. Epson is not responsible for any use of this information as applied to other products.

Neither Seiko Epson Corporation nor its affiliates shall be liable to the purchaser of this product or third parties for damages, losses, costs, or expenses incurred by the purchaser or third parties as a result of accident, misuse, or abuse of this product or unauthorized modifications, repairs, or alterations to this product, or (excluding the U.S.) failure to strictly comply with Seiko Epson Corporation's operating and maintenance instructions.

Seiko Epson Corporation and its affiliates shall not be liable for any damages or problems arising from the use of any options or any consumable products other than those designated as Original Epson Products or Epson Approved Products by Seiko Epson Corporation.

Seiko Epson Corporation shall not be held liable for any damage resulting from electromagnetic interference that occurs from the use of any interface cables other than those designated as Epson Approved Products by Seiko Epson Corporation.

© 2020 Seiko Epson Corporation

The contents of this manual and the specifications of this product are subject to change without notice.

Trademarks

- ❑ EPSON, EPSON EXCEED YOUR VISION, EXCEED YOUR VISION and their logos are registered trademarks or trademarks of Seiko Epson.
- ❑ Microsoft® and Windows® are registered trademarks of Microsoft Corporation.
- ❑ Apple, macOS, and OS X are registered trademarks of Apple, Inc.
- ❑ General Notice: Other product names used herein are for identification purposes only and may be trademarks of their respective owners. Epson disclaims any and all rights in those marks.

Contents

Copyright

Trademarks

About This Manual

Introduction to the Manuals.	8
Marks and Symbols.	8
Descriptions Used in this Manual.	8
Operating System References.	8

Important Instructions

Safety Instructions.	11
Restrictions on Copying.	12

Product Features

Three Elements of a Network Scanner that are Useful for Business.	14
Paper Protection to Reduce Damage to the Originals.	14
Notification of Dirt on the Sensor.	15

Scanner Basics

Part Names and Functions.	17
Control Panel.	19
Buttons and Light.	19
Guide to the LCD Screen.	19
Information on Applications.	21
Application for Scanning Documents (Document Capture Pro / Document Capture).	21
Application for Controlling the Scanner (Epson Scan 2).	22
Application for Using the Scanner Through a Server (Document Capture Pro Server).	22
Application for Updating Software and Firmware (EPSON Software Updater).	22
Application for Configuring Scanner Operations (Web Config).	23
Application for Setting up the Device on a Network (EpsonNet Config).	24
Software for Managing Devices on the Network (Epson Device Admin).	25
Application for Creating Driver Packages (EpsonNet SetupManager).	25
Option Items and Consumables Information.	25

Carrier Sheet Codes.	25
Roller Assembly Kit Codes.	26
Cleaning Kit Codes.	26

Specifications of Originals and Placing Originals

Specifications of Originals.	28
General Specifications for Originals being Scanned.	28
Types of Originals that Require Attention.	31
Types of Originals that Must Not be Scanned.	32
Placing Originals.	33
Standard Size Originals.	33
Long Paper.	38
Plastic Cards.	41
Laminated Cards.	44
Large Size Originals.	46
Irregular Shaped Originals.	49
Photographs.	51
Envelopes.	54
Mixture of Originals.	57

Preparing to Scan over a Network

Connecting the Scanner to the Network.	62
Configuring a Mail Server.	62
Mail Server Setting Items.	63
Checking a Mail Server Connection.	63
Setting a Shared Network Folder.	65
Creating the Shared Folder.	65
Making Contacts Available.	80
Contacts Configuration Comparison.	81
Registering a Destination to Contacts using Web Config.	81
Registering Destinations as a Group Using Web Config.	83
Backing Up and Importing Contacts.	83
Export and Bulk Registration of Contacts Using Tool.	84
Using Document Capture Pro Server.	86
Setting Server Mode.	86
Registering Preset or Quick Send Buttons.	87
Email Settings.	88
File Settings.	88
Scan Settings.	88
PDF Settings.	90

Basic Scanning

Scanning Using the Scanner's Control Panel.	92
Scanning Using Quick Send Buttons.	92
Scanning Using Preset Settings.	93
Scanning Originals to a Computer.	93
Scanning Using WSD.	94
Scanning from a Computer.	96
Scanning Using Document Capture Pro (Windows).	96
Scanning Using Document Capture (Mac OS).	103
Scanning Using Epson Scan 2.	109

Advanced Scanning

Setting a Job.	115
Creating and Registering a Job (Windows).	115
Creating and Registering a Job (Mac OS).	121
Enabling a Job to Run from the Control Panel (Button Assignment).	122
Scanning Different Sizes or Types of Originals One by One (Automatic Feeding Mode).	124
Various Scanning Settings for Document Capture Pro (for Windows Only).	126
Dividing documents using a specified number of pages.	127
Dividing documents using blank sheets of paper	130
Creating and saving folders using the barcode character information.	133
Creating two levels of folders using two types of barcode.	138
Saving files with file names using the barcode character information.	142
Creating and saving folders using OCR characters.	146
Saving files with file names using OCR characters.	151
Creating and saving folders for each form.	158

Menu Options on the Control Panel

Computer.	164
Edit Job.	164
Quick Send/Presets.	164
WSD.	165
Device Information.	165
Scanner Maintenance.	166
Settings.	166
Basic Settings.	166
Scanner Settings.	167
Document Capture Pro.	169

System Administration.	169
Roller Replacement Alert Setting.	170
Regular Cleaning Alert Settings.	170
Network Status.	170

Maintenance

Cleaning Outside the Scanner.	172
Cleaning Inside the Scanner.	172
Replacing the Roller Assembly Kit.	177
Resetting the Number of Scans.	181
Energy Saving.	182
Transporting the Scanner.	182
Updating Applications and Firmware.	183
Updating Firmware Using Web Config.	184

Solving Problems

Scanner Problems.	186
Checking Error Messages on the Control Panel.	186
The Scanner Does Not Turn On.	186
Forgot Your Administrator's Password.	187
Problems when Preparing Network Scanning.	187
Hints to Solving Problems.	187
Cannot Access Web Config.	187
Problems Starting Scanning.	188
Cannot Start Scanning from Computer.	188
Cannot Save Scanned Images to the Shared Folder.	192
Cannot Send Scanned Images to an Email.	193
Paper Feeding Problems.	194
Multiple Originals Are Fed (Double Feed).	194
Removing Jammed Originals from the Scanner.	194
The Original Jams in the Scanner Frequently.	196
Paper Protection Does not Work Correctly.	196
The Originals Get Dirty.	196
Scanning Speed Slows Down when Scanning Continuously.	197
Scanning Takes a Long Time.	197
Scanned Image Problems.	197
Straight Lines Appear when Scanning from ADF.	197
Glass Dirt Alert Does Not Disappear.	198
Colors Are Uneven in the Scanned Image.	198
Expanding or Contracting the Scanned Image.	198
Offset Appears in the Background of Images.	199
Scanned Image or Text is Blurred.	199
Moiré Patterns (Web-Like Shadows) Appear.	200

The Edge of the Original is Not Scanned when Automatically Detecting the Size of the Original.	200
Character is not Recognized Correctly.	201
Cannot Solve Problems in the Scanned Image.	201
Uninstalling and Installing Applications.	202
Uninstalling Your Applications.	202
Installing Your Applications.	203

Adding or Replacing the Computer or Devices

Connecting to a Scanner that has been Connected to the Network.	205
Using a Network Scanner from a Second Computer.	205
Re-setting the Network Connection.	206
When Changing the Computer.	206
Changing the Connection Method to the Computer.	206
Checking the Network Connection Status.	207
Checking the Network Connection Status from the Control Panel.	207
Checking the Network of the Computer (Windows only).	207

Administrator Information

Connect the Scanner to the Network Manually.	210
Before Making Network Connection.	210
Connecting to the Network Using a Static IP Address.	211
Introduction of Product Security Features.	212
Administrator Settings.	212
Configuring the Administrator Password.	212
Controlling the Panel Operation.	213
Logging on to the Scanner as an Administrator.	216
Disabling the External Interface.	217
Monitoring a Remote Scanner.	217
Checking Information for a Remote Scanner.	217
Receiving Email Notifications When Events Occur.	218
Backing Up the Settings.	219
Export the settings.	219
Import the settings.	219
Advanced Security Settings.	220
Security Settings and Prevention of Danger.	220
Controlling Using Protocols.	221
Using a Digital Certificate.	224
SSL/TLS Communication with the Scanner.	229

Encrypted Communication Using IPsec/IP Filtering.	231
Connecting the Scanner to an IEEE802.1X Network.	241
Solving Problems for Advanced Security.	243

Technical Specifications

General Scanner Specifications.	250
Network Specifications.	251
Ethernet Specifications.	251
Network Functions and IPv4/IPv6.	251
Security Protocol.	251
Using Port for the Scanner.	251
Dimensions and Weight Specifications.	252
Electrical Specifications.	253
Scanner Electrical Specifications.	253
AC Adapter Electrical Specifications.	253
Environmental Specifications.	254
System Requirements.	254

Standards and Approvals

Standards and Approvals for European Models.	256
Standards and Approvals for U.S. Models.	256

Where to Get Help

Technical Support Web Site.	258
Contacting Epson Support.	258
Before Contacting Epson.	258
Help for Users in Europe.	258
Help for Users in Taiwan.	258
Help for Users in Singapore.	259
Help for Users in Thailand.	259
Help for Users in Vietnam.	260
Help for Users in Indonesia.	260
Help for Users in Hong Kong.	262
Help for Users in Malaysia.	262
Help for Users in India.	263
Help for Users in the Philippines.	263

About This Manual

Introduction to the Manuals.	8
Marks and Symbols.8
Descriptions Used in this Manual.	8
Operating System References.8

Introduction to the Manuals

The latest versions of the following manuals are available from the Epson support website.

<http://www.epson.eu/support> (Europe)

<http://support.epson.net/> (outside Europe)

Start Here (paper manual)

Provides you with information on setting up the product and installing the application.

User's Guide (digital manual)

Provides instructions on using the product, maintenance, and solving problems.

As well as the manuals above, see the help included in the various Epson applications.

Marks and Symbols



Caution:

Instructions that must be followed carefully to avoid bodily injury.



Important:

Instructions that must be observed to avoid damage to your equipment.

Note:

Provides complementary and reference information.

Related Information

➔ Links to related sections.

Descriptions Used in this Manual

- Screenshots for the applications are from Windows 10 or macOS High Sierra. The content displayed on the screens varies depending on the model and situation.
- Illustrations used in this manual are for reference only. Although they may differ slightly from the actual product, the operating methods are the same.

Operating System References

Windows

In this manual, terms such as "Windows 10", "Windows 8.1", "Windows 8", and "Windows 7" refer to the following operating systems. Additionally, "Windows" is used to refer to all versions.

- Microsoft® Windows® 10 operating system

- Microsoft® Windows® 8.1 operating system
- Microsoft® Windows® 8 operating system
- Microsoft® Windows® 7 operating system

Mac OS

In this manual, "Mac OS" is used to refer to macOS Catalina, macOS Mojave, macOS High Sierra, macOS Sierra, OS X El Capitan, and OS X Yosemite.



Important Instructions

Safety Instructions. 11

Restrictions on Copying. 12

Safety Instructions

Read and follow these instructions to ensure safe use of this product and options. Make sure you keep this manual for future reference. Also, be sure to follow all warnings and instructions marked on the product and options.

- ❑ Some of the symbols used on your product and options are to ensure safety and proper use of the product. Visit the following Web site to learn the meaning of the symbols.

<http://support.epson.net/symbols>

- ❑ Place the product and options on a flat, stable surface that extends beyond the base of the product and options in all directions. If you place the product and options by the wall, leave more than 10 cm between the back of the product and options and the wall.
- ❑ Place the product and options close enough to the computer for the interface cable to reach it easily. Do not place or store the product and options or the AC adapter outdoors, near excessive dirt or dust, water, heat sources, or in locations subject to shocks, vibrations, high temperature or humidity, direct sunlight, strong light sources, or rapid changes in temperature or humidity.
- ❑ Do not use with wet hands.
- ❑ Place the product and options near an electrical outlet where the adapter can be easily unplugged.
- ❑ The AC adapter cord should be placed to avoid abrasions, cuts, fraying, crimping, and kinking. Do not place objects on top of the cord and do not allow the AC adapter or the cord to be stepped on or run over. Be particularly careful to keep the cord straight at the end.
- ❑ Use only the power cord supplied with the product and do not use the cord with any other equipment. Use of other cords with this product or the use of the supplied power cord with other equipment may result in fire or electric shock.
- ❑ Use only the AC adapter that comes with your product. Using any other adapter could cause fire, electrical shock, or injury.
- ❑ The AC adapter is designed for use with the product with which it was included. Do not attempt to use it with other electronic devices unless specified.
- ❑ Use only the type of power source indicated on the AC adapter's label, and always supply power directly from a standard domestic electrical outlet with the AC adapter that meets the relevant local safety standards.
- ❑ When connecting this product and options to a computer or other device with a cable, ensure the correct orientation of the connectors. Each connector has only one correct orientation. Inserting a connector in the wrong orientation may damage both devices connected by the cable.
- ❑ Avoid using outlets on the same circuit as photocopiers or air control systems that regularly switch on and off.
- ❑ If you use an extension cord with the product, make sure the total ampere rating of the devices plugged into the extension cord does not exceed the cord's ampere rating. Also, make sure the total ampere rating of all devices plugged into the wall outlet does not exceed the wall outlet's ampere rating.
- ❑ Never disassemble, modify, or attempt to repair the AC adapter, product, or product options by yourself except as specifically explained in the product's guides.
- ❑ Do not insert objects into any opening as they may touch dangerous voltage points or short out parts. Beware of electrical shock hazards.
- ❑ If damage occurs to the plug, replace the cord set or consult a qualified electrician. If there are fuses in the plug, make sure you replace them with fuses of the correct size and rating.
- ❑ Unplug the product, options, and the AC adapter, and refer servicing to qualified service personnel under the following conditions: The AC adapter or plug is damaged; liquid has entered the product, options, or the AC adapter; the product or the AC adapter has been dropped or the case has been damaged; the product, options, or the AC adapter does not operate normally or exhibits a distinct change in performance. (Do not adjust controls that are not covered by the operating instructions.)

- Unplug the product and the AC adapter before cleaning. Clean with a damp cloth only. Do not use liquid or aerosol cleaners except as specifically explained in the product's guides.
- If you are not going to use the product for a long period, be sure to unplug the AC adapter from the electrical outlet.
- After replacing consumable parts, dispose of them correctly following the rules of your local authority. Do not disassemble them.
- If the LCD screen is damaged, contact your dealer. If the liquid crystal solution gets on your hands, wash them thoroughly with soap and water. If the liquid crystal solution gets into your eyes, flush them immediately with water. If discomfort or vision problems remain after a thorough flushing, see a doctor immediately.

Restrictions on Copying

Observe the following restrictions to ensure the responsible and legal use of your product.

Copying of the following items is prohibited by law:

- Bank bills, coins, government-issued marketable securities, government bond securities, and municipal securities
- Unused postage stamps, pre-stamped postcards, and other official postal items bearing valid postage
- Government-issued revenue stamps, and securities issued according to legal procedure

Exercise caution when copying the following items:

- Private marketable securities (stock certificates, negotiable notes, checks, etc.), monthly passes, concession tickets, etc.
- Passports, driver's licenses, warrants of fitness, road passes, food stamps, tickets, etc.

Note:

Copying these items may also be prohibited by law.

Responsible use of copyrighted materials:

Products can be misused by improperly copying copyrighted materials. Unless acting on the advice of a knowledgeable attorney, be responsible and respectful by obtaining the permission of the copyright holder before copying published material.



Product Features

Three Elements of a Network Scanner that are Useful for Business.	14
Paper Protection to Reduce Damage to the Originals.	14
Notification of Dirt on the Sensor.	15

Three Elements of a Network Scanner that are Useful for Business

This scanner is a network scanner which has three elements, “Computerless”, “Share”, and “Secure”.

“Computerless”

You can send scanned images to selected destination (such as a network folder or email) simply by operating the scanner's control panel without having to use a computer.

Note:

“Scanning Using the Scanner’s Control Panel” on page 92

“Share”

You can check the scanning settings on the color LCD screen built into the scanner.

By registering frequently used scanning settings as presets, you can perform scanning easily by selecting a preset name. This feature is useful when sharing the scanner with more than one person.

“Secure”

You can register the destination settings to the Preset and  (Quick Send) buttons. You can prevent mistakes by checking the destination on the LCD screen before sending.

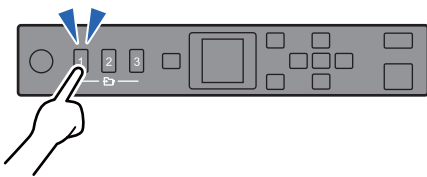

Note:

“Registering Preset or Quick Send Buttons” on page 87

Paper Protection to Reduce Damage to the Originals

This scanner comes with a paper protection feature. This feature reduces damage to originals by stopping scanning when it detects a feeding error, such as when scanning stapled documents by mistake.



Notification of Dirt on the Sensor

This scanner can detect dirt on the scanning sensor, and notifies you that you need to clean the sensor before dirt can cause lines in the scanned images.

You can easily keep the sensor clean, and avoid a decline in image quality.

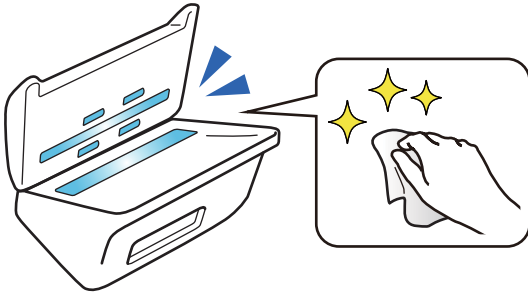

Scanner Basics

Part Names and Functions.	17
Control Panel.	19
Information on Applications.	21
Option Items and Consumables Information.	25

Part Names and Functions

Front

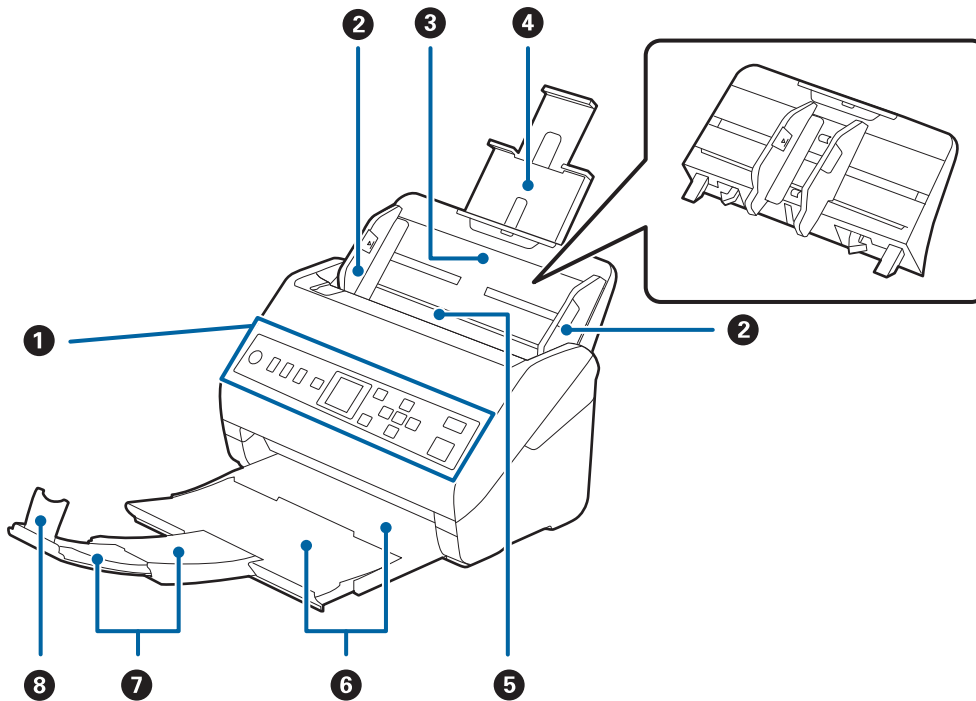

①	Control panel	Indicates the scanner's status and allows you to make scanning settings.
②	Edge guides	Feeds originals straight into the scanner. Slide to the edges of the originals.
③	Input tray	Loads originals. Pull out the tray extension if originals are too big for the input tray. This prevents paper from curling and causing paper jams. When removing the input tray, slide the hooks that are on both ends at the back, and then pull out the input tray.
④	Input tray extension	
⑤	ADF (Automatic Document Feeder)	Feeds loaded originals automatically.
⑥	Output tray	Holds originals ejected from the scanner. Pull out the output tray extension to the length of the originals.
⑦	Output tray extension	
⑧	Stopper	Prevents ejected originals from falling off the extension tray. Adjust it to the length of the originals.

Rear

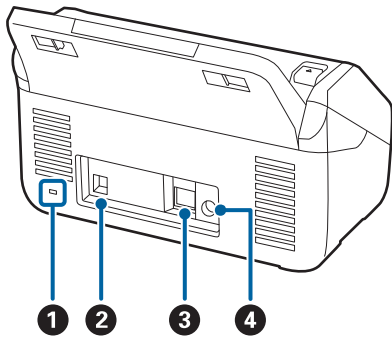

①	Security slot	Inserts a security lock for theft prevention.
②	USB port	Connects a USB cable.
③	LAN port	Connects a LAN cable.
④	DC inlet	Connects the AC adapter.

Inside

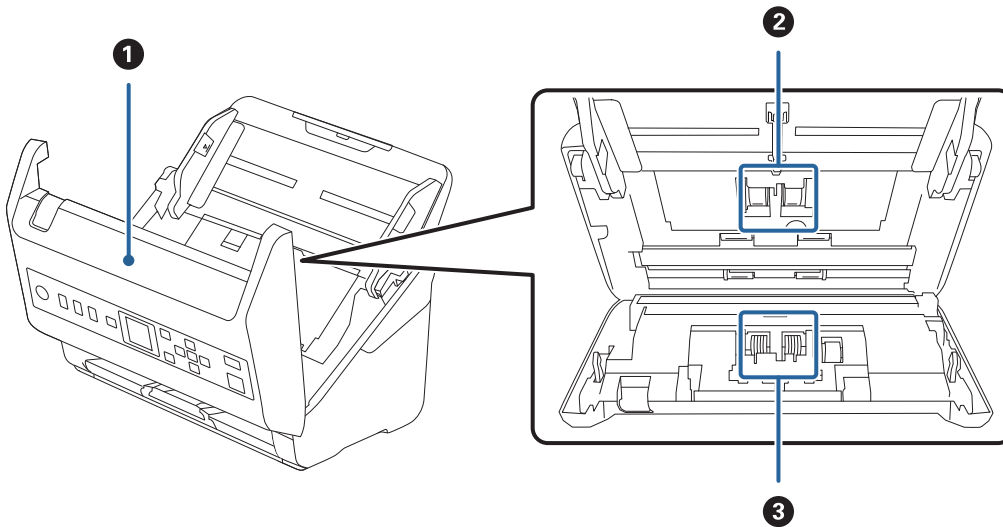

①	Scanner cover	Pull the lever and open the scanner cover when cleaning inside the scanner and removing jammed paper.
②	Pickup roller	Feeds originals. This needs to be replaced when the number of scans exceeds the service number of papers.
③	Separation roller	Feeds originals separately one by one. This needs to be replaced when the number of scans exceeds the service number of papers.

Related Information

- ➔ [“Cleaning Inside the Scanner” on page 172](#)
- ➔ [“Replacing the Roller Assembly Kit” on page 177](#)

Control Panel

Buttons and Light

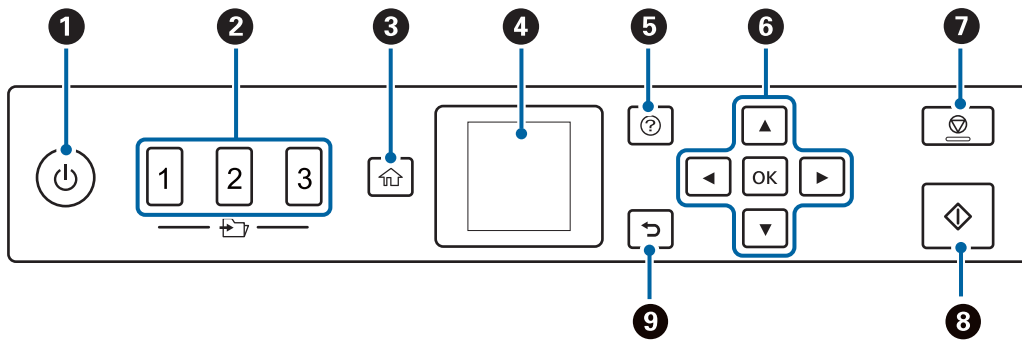

1	<p>Turns the scanner on or off.</p> <p>Do not turn off the scanner while the light is flashing because the scanner is operating or processing a job.</p>
2	<p>Uses the Quick Send feature.</p> <p>You can send scanned image to a destination that has been pre-configured in Web Config. You can assign a network folder or an email address as the destination.</p>
3	<p>Displays the home screen.</p>
4	<p>Displays menus and messages.</p>
5	<p>Displays the help screen.</p> <p>You can check how to solve problems and how to load originals.</p>
6	<p>Use the ▲▼◀▶ buttons to highlight an item, and then press the OK button to open the selected menu or to make settings.</p>
7	<ul style="list-style-type: none"> <input type="checkbox"/> Cancels scanning or the current operation. <input type="checkbox"/> Exits Automatic Feeding Mode. <input type="checkbox"/> Clears setting changes on the Edit Job screen.
8	<ul style="list-style-type: none"> <input type="checkbox"/> Starts scanning. <input type="checkbox"/> Press this when cleaning the inside of the scanner.
9	<p>Returns to the previous screen.</p>



Guide to the LCD Screen

Menus and messages are displayed on the LCD screen. Select a menu or setting by pressing the ▲▼◀▶ buttons.

Guide to the Home Screen

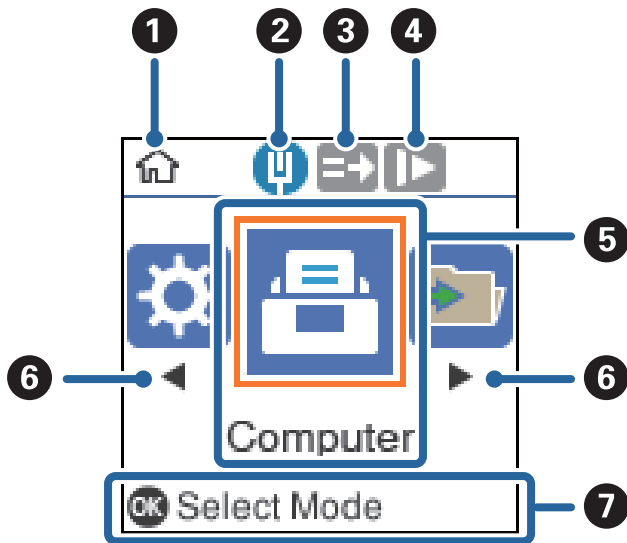
The following icons and menus are displayed on the home screen.



1	This icon indicates that you are on the home screen.
2	Displays the network connection status.
3	This icon indicates whether or not the DFDS Function (Double Feed Detection Skip Function) feature is enabled. When enabled, the icon changes to  . Skips double feed detection once and continues scanning. Enable this to scan originals that are detected as double feeds, for example plastic cards or envelopes.
4	This icon indicates whether or not the Slow feature is enabled. When enabled, the icon changes to  . Slows down the scanning speed. Enable this to scan originals that are likely to jam, for example thin paper.
5	Function icons and names are displayed as menu icons.
6	When ◀ and ▶ are displayed, you can use them to scroll right or left.
7	Displays available buttons. In this example, you can go to the selected menu by pressing the OK button.

Related Information

➔ [“Menu Options on the Control Panel” on page 163](#)

Viewing Guidance Animations

You can watch animated guides that explain how to maintain the scanner, replace the rollers, place various kind of originals, and so on.

- Press the  button on the scanner to display the help screen. Select **How To**, and then select the items that you want to view.

- ❑ Press the **OK** button when **How To** appears at the bottom of the operation screen to display context-sensitive animations.

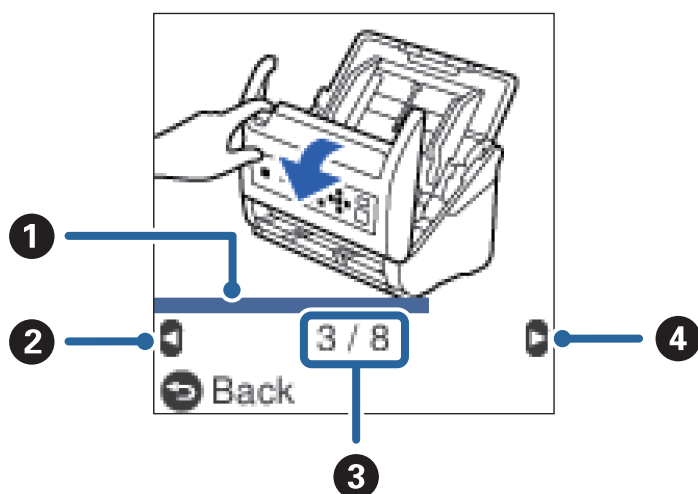

❶	Indicates your progress through the current step. The animation repeats when the progress bar reaches the end.
❷	Press the ◀ button to return to the previous step.
❸	Indicates the total number of steps and the current step number. The example shows step 3 of 8.
❹	Press the ▶ button to go to the next step.

Information on Applications

This section introduces the application products available for your scanner. The latest application can be installed at the Epson Web site.

Application for Scanning Documents (Document Capture Pro / Document Capture)

Document Capture Pro* is an application that allows you to efficiently scan originals such as documents.

You can register a set of operations, such as Scan-Save-Send, as a “job”. By registering a series of operations in advance as a job, you can perform all of the operations by simply selecting the job. By assigning a job to the scanner’s control panel, you can start a job from the control panel (Button Assignment).

See the Document Capture Pro help (Windows) or Document Capture (Mac OS) for details on using the application.

*The names are for Windows. For Mac OS, the name is Document Capture.

Starting on Windows

- ❑ Windows 10

Click the start button, and then select **Epson Software > Document Capture Pro**.

Windows 8.1/Windows 8

Enter the application name in the search charm, and then select the displayed icon.

Windows 7

Click the start button, and then select **All Programs > Epson Software > Document Capture Pro**.

Starting on Mac OS

Select **Go > Applications > Epson Software > Document Capture**.

Application for Controlling the Scanner (Epson Scan 2)

Epson Scan 2 is a scanner driver that allows you to control the scanner. You can adjust the size, resolution, brightness, contrast, and quality of the scanned image. You can also start this application from a TWAIN-compliant scanning application.

See the Epson Scan 2 help for details on using the application.

Starting on Windows

Windows 10

Click the start button, and then select **EPSON > Epson Scan 2**.

Windows 8.1/Windows 8

Enter the application name in the search charm, and then select the displayed icon.

Windows 7

Click the start button, and then select **All apps > EPSON > Epson Scan 2**.

Starting on Mac OS

Select **Go > Applications > Epson Software > Epson Scan 2**.

Application for Using the Scanner Through a Server (Document Capture Pro Server)

Document Capture Pro Server is an application for Windows Server that allows you to manage up to 100 scanners on the network through servers.

By using a web browser, you can register and monitor scanners or register jobs: **1. Scan > 2. Save > 3. Send** and assign them to individual scanners. You can scan by simply selecting a job on a scanner managed by Document Capture Pro Server.

For further information, contact your local Epson office.

Application for Updating Software and Firmware (EPSON Software Updater)

EPSON Software Updater is an application that installs new software, and updates firmware and manuals over the Internet. If you want to check for update information regularly, you can set the interval for checking for updates in EPSON Software Updater's auto update settings.

Starting on Windows

Windows 10

Click the start button, and then select **Epson Software > EPSON Software Updater**.

Windows 8.1/Windows 8

Enter the application name in the search charm, and then select the displayed icon.

Windows 7

Click the start button, and then select **All Programs > Epson Software > EPSON Software Updater**.

Starting on Mac OS

Select **Go > Applications > Epson Software > EPSON Software Updater**.

Application for Configuring Scanner Operations (Web Config)

Web Config is an application that runs in a web browser, such as Internet Explorer and Safari, on a computer or smart device. You can confirm the scanner status or change the network service and scanner settings. To use the Web Config, connect the scanner and the computer or device to the same network.

The following browsers are supported.

Microsoft Edge, Internet Explorer 8 or later, Firefox*, Chrome*, Safari*

* Use the latest version.

Running Web Config on a Web Browser

1. Check the scanner's IP address.

Select **Settings > Network Status > IP Address** on the scanner's control panel to confirm the scanner's IP address.

2. Launch a Web browser from a computer or smart device, and then enter the scanner's IP address.

Format:

IPv4: http://the scanner's IP address/

IPv6: http://[the scanner's IP address]/

Examples:

IPv4: http://192.168.100.201/

IPv6: http://[2001:db8::1000:1]/

Note:

- Since the scanner uses a self-signed certificate when accessing HTTPS, a warning is displayed on the browser when you start Web Config; this does not indicate a problem and can be safely ignored.
- If the administrator password has not been set when accessing Web Config, you need to set a user name and password.



Important:

Do not forget the user name and the password. If you forget them, you will need to contact Epson service support.

3. If you want to change the scanner settings, you need to login as an administrator.
Click **Administrator Login** at the top-right of the screen. Enter the **User Name** and **Current password**, and then click **OK**.

Note:

*If **Administrator Logout** is displayed at the top-right of the screen, you have already logged-on as an administrator.*

Running Web Config on Windows

When connecting a computer to the scanner using WSD, follow the steps below to run Web Config.

1. Open the scanner list on the computer.
 - Windows 10
Click on the start button, and then select **Windows System > Control Panel > View devices and printers** in **Hardware and Sound**.
 - Windows 8.1/Windows 8
Select **Desktop > Settings > Control Panel > View devices and printers** in **Hardware and Sound** (or **Hardware**).
 - Windows 7
Click the start button, and select **Control Panel > View devices and printers** in **Hardware and Sound**.
2. Right-click on your scanner and select **Properties**.
3. Select the **Web Service** tab and click the URL.

Since the scanner uses a self-signed certificate when accessing HTTPS, a warning is displayed on the browser when you start Web Config; this does not indicate a problem and can be safely ignored.

Note:

If the administrator password has not been set when accessing Web Config, you need to set a user name and password.



Important:

Do not forget the user name and the password. If you forget them, you will need to contact Epson service support.

Application for Setting up the Device on a Network (EpsonNet Config)

EpsonNet Config is an application that allows you to set the network interface addresses and protocols. See the operations guide for EpsonNet Config or the application's help for more details.

Starting on Windows

- Windows 10
Click the start button, and then select **EpsonNet > EpsonNet Config**.
- Windows 8.1/Windows 8
Enter the application name in the search charm, and then select the displayed icon.

- Windows 7/Windows Vista

Click the start button, and select **All Programs** or **Programs > EpsonNet > EpsonNet Config SE > EpsonNet Config**.

Starting on Mac OS

Go > **Applications > Epson Software > EpsonNet > EpsonNet Config SE > EpsonNet Config**.

Software for Managing Devices on the Network (Epson Device Admin)

Epson Device Admin is a multifunctional application software that manages the device on the network.

The following functions are available.

- Monitor or manage up to 2,000 printers or scanners over the segment
- Make a detailed report, such as for the consumable or product status
- Update the firmware of the product
- Introduce the device to the network
- Apply the unified settings to multiple devices.

You can download Epson Device Admin from Epson support website. For more information, see the documentation or help of Epson Device Admin.

Application for Creating Driver Packages (EpsonNet SetupManager)

EpsonNet SetupManager is a software to create a package for a simple scanner installation, such as installing the scanner driver and so on. This software allows the administrator to create unique software packages and distribute them among groups.

For more information, visit your regional Epson website.

<http://www.epson.com>

Option Items and Consumables Information

Carrier Sheet Codes

Using a Carrier Sheet allows you to scan irregular shaped originals or photos that can be easily scratched. You can scan originals larger than A4 size with a carrier sheet by folding it in half.

Part name	Codes*
Carrier Sheet	B12B819051

* You can only use the carrier sheet with the code.

Related Information

- ➔ [“General Specifications for Originals being Scanned” on page 28](#)
- ➔ [“Placing Large Size Originals” on page 46](#)
- ➔ [“Placing Irregular Shaped Originals” on page 49](#)
- ➔ [“Placing Photographs” on page 52](#)

Roller Assembly Kit Codes

Parts (the pickup roller and separation roller) should be replaced when the number of scans exceeds the service number. You can check the latest number of scans on the control panel or in the Epson Scan 2 Utility.

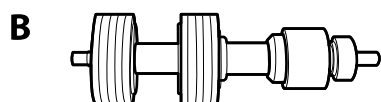
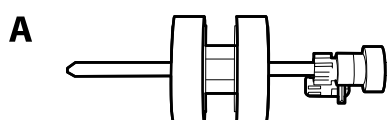

A: pickup roller, B: separation roller

Part name	Codes	Life cycle
Roller Assembly Kit	B12B819671 B12B819681 (India only)	200,000*

* This number was reached by consecutively scanning using Epson test original papers, and is a guide to the replacement cycle. The replacement cycle may vary depending on different paper types, such as paper that generates a lot of paper dust or paper with a rough surface that may shorten the life cycle.

Related Information

- ➔ [“Replacing the Roller Assembly Kit” on page 177](#)
- ➔ [“Resetting the Number of Scans” on page 181](#)

Cleaning Kit Codes

Use this when cleaning inside the scanner. This kit is composed of cleaning liquid and a cleaning cloth.

Part name	Codes
Cleaning Kit	B12B819291

Related Information

- ➔ [“Cleaning Inside the Scanner” on page 172](#)

Specifications of Originals and Placing Originals

Specifications of Originals.	28
Placing Originals.	33

Specifications of Originals

This section explains the specifications and conditions of originals that can be loaded in the ADF.

General Specifications for Originals being Scanned

Type of Original	Thickness	Size
Plain paper	27 to 413 g/m ²	Maximum: 215.9×6,096.0 mm (8.5×240.0 in.)
Fine paper	A8 size or less: 127 to 413 g/m ²	Minimum: 50.8×50.8 mm (2.0×2.0 in.)
Recycled paper	Plastic cards: 1.24 mm (0.05 in.) or less (including emboss)	The loadable size varies depending on the type of the originals and the scanning resolution.
Post card	Laminated Cards: 0.8 mm (0.03 in.) or less	
Business card		
Envelopes		
Plastic cards complying with ISO7810 ID-1 type (with or without emboss)		
Laminated cards		
Thermal paper		

Note:

- ❑ All originals must be flat at the leading edge.
- ❑ Make sure that curls on the leading edge of the originals are kept within the following range.
 - ① must be 3 mm or less.
 - ② must be 1 mm or less while ② is equal to or less than ③. When ③ is equal to or more than 10 times the size of ②, ② can be more than 1 mm.

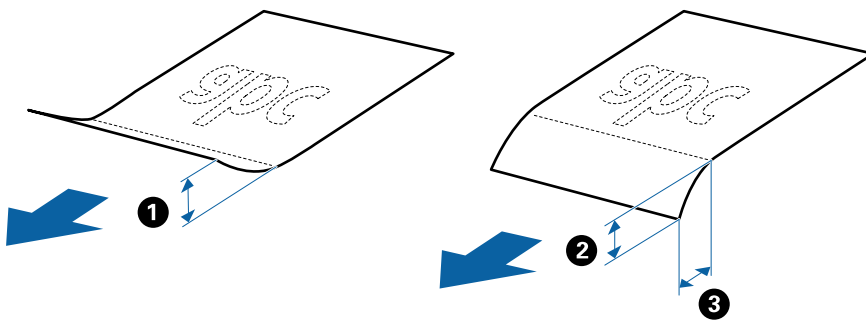

- ❑ Even when the original meets the specifications for originals that can be placed in the ADF, it may not feed from the ADF or the scan quality may decline depending on the paper properties or quality.

Specifications of Standard Size Originals

The list of the standard size originals you can load on the scanner.

Size	Measurement	Thickness	Paper Type	Loading Capacity *
Legal	215.9×355.6 mm (8.5×14 in.)	27 to 413 g/m ²	Plain paper Fine paper Recycled paper	Thickness of the originals stack: under 12 mm (0.47 in.) 80 g/m ² : 80 sheets 90 g/m ² : 69 sheets 104 g/m ² : 59 sheets 127 g/m ² : 50 sheets 157 g/m ² : 40 sheets 209 g/m ² : 30 sheets 256 g/m ² : 24 sheets 413 g/m ² : 14 sheets The loading capacity varies depending on the paper type.
Letter	215.9×279.4 mm (8.5×11 in.)			Thickness of the originals stack: under 12 mm (0.47 in.)
A4	210×297 mm (8.3×11.7 in.)			80 g/m ² : 100 sheets 90 g/m ² : 86 sheets 104 g/m ² : 74 sheets
B5	182×257 mm (7.2×10.1 in.)			127 g/m ² : 62 sheets 157 g/m ² : 50 sheets
A5	148×210 mm (5.8×8.3 in.)			209 g/m ² : 38 sheets 256 g/m ² : 30 sheets
B6	128×182 mm (5.0×7.2 in.)			413 g/m ² : 18 sheets The loading capacity varies depending on the paper type.
A6	105×148 mm (4.1×5.8 in.)			
A8	52×74 mm (2.1×2.9 in.)	127 to 413 g/m ²		
Business Card	55×89 mm (2.1×3.4 in.)	210 g/m ²		Thickness of the originals stack: under 12 mm (0.47 in.) 30 sheets

* You can refill the originals up to the maximum capacity during scanning.

Specifications of Long Paper

The specification of long paper you can load into the scanner.

Size	Thickness	Paper Type	Loading Capacity
Maximum width: 215.9 mm (8.5 in.) Maximum length: 6,096.0 mm (240.0 in.)*	50 to 130 g/m ²	Plain paper Fine paper Recycled paper	1 sheet

*The following shows the maximum lengths according to the scanning resolution.

- 50 to 200 dpi : 6,096.0 mm (240.0 in.)
- 201 to 300 dpi : 5,461.0 mm (215.0 in.)
- 301 to 600 dpi : 1,346.0 mm (53.0 in.)

Specifications of Plastic Cards

The specification of plastic card you can load into the scanner.

Size	Card Type	Thickness	Loading Capacity	Loading Direction
ISO7810 ID-1 Type 54.0×85.6 mm (2.1×3.3 in.)	With embossing	1.24 mm (0.05 in.) or less	1 card	Horizontal (Landscape)
	Without embossing	0.76 mm (0.03 in.) to 1.1 mm (0.04 in.) *	5 cards	
		Less than 0.76 mm (0.03 in.)	5 cards	

* You can scan these cards only when the resolution is 300 dpi or less, and disabling **Slow** mode.

Specifications of Laminated Cards

The specification of laminated cards you can load into the scanner.

Size	Thickness	Loading Capacity
120.0×150.0 mm (4.7×5.9 in.) or less	0.8 mm (0.03 in.) or less	1 card

Specifications for Originals Using the Carrier Sheet

The optional Carrier Sheet is a sheet designed to transport originals through the scanner. You can scan originals that are larger than A4/Letter size, important documents or photos which must not damaged, thin paper, irregular shaped originals, and so on.

The following table provides the conditions for using the Carrier Sheet.

Type	Size	Thickness	Loading Capacity of the Carrier Sheet
Originals that cannot be loaded directly into the scanner	A3* ¹ A4 B4* ¹ Letter Legal* ¹ B5 A5 B6 A6 A8 Custom size: <input type="checkbox"/> Width: up to 431.8 mm (17 in.) * ² <input type="checkbox"/> Length: up to 297 mm (11.7 in.) * ³	0.3 mm (0.012 in.) or less (excluding the thickness of the Carrier Sheet)	10 sheets

*1 Fold in half to set.

*2 Originals that are wider than 215.9 mm (8.5 in.) need to be folded in half.

*3 The leading edge of the original must be placed at the binding part of the Carrier Sheet when scanning an original approximately 297 mm (11.7 in.) long. Otherwise, the length of the scanned image may be longer than intended as the scanner scans to the end of the Carrier Sheet when you select **Auto Detect** as the **Document Size** setting in the application.

Related Information

➔ [“Carrier Sheet Codes” on page 25](#)

Specifications of Envelopes

The specification of envelopes you can load into the scanner.

Size	Measurement	Thickness	Loading Capacity
C6	114×162 mm (4.49×6.38 in.) (standard size)	0.38 mm (0.015 in.) or less	10 envelopes
DL	110×220 mm (4.33×8.66 in.) (standard size)		

Types of Originals that Require Attention

The following types of originals may not be successfully scanned.

Originals with an uneven surface such as letter head paper.

- Originals with wrinkles or fold lines
- Perforated originals
- Original with labels or stickers
- Carbon-less paper
- Curled originals
- Coated paper



Important:

Carbon-less paper contains chemical substances that may harm the rollers. If you scan carbon-less paper, clean the pickup roller and the separation roller regularly. Also, scanning carbon-less paper may shorten the life cycle of the rollers faster than scanning plain paper.

Note:

- Crinkled originals may scan better if you slow down the feeding speed during scanning or smooth out the crinkles before loading.*
- To scan delicate originals or originals that are easily crinkled, use the Carrier Sheet (sold separately).*
- To scan originals that are incorrectly detected as double feeds, set the **DFDS Function** (Double Feed Detection Skip Function) to **On** on the control panel before you resume scanning, or select **Off** in **Detect Double Feed** on the **Main Settings** tab in the Epson Scan 2 window.
*When you are using Document Capture Pro, you can open the window by pressing the **Detailed Settings** button on the **Scan Settings** screen.**
- Labels or stickers must be firmly stuck to the originals with no glue protruding.*
- Try to flatten the curled originals before scanning.*

Related Information

- ➔ [“Scanner Basics” on page 16](#)
- ➔ [“Maintenance” on page 171](#)

Types of Originals that Must Not be Scanned

The following types of originals must not be scanned.

- Photos
- Booklets
- Bank books
- Passports
- Non-paper original (such as clear files, fabric, and metal foil)
- Originals with staples or paper clips
- Originals with glue attached
- Ripped originals
- Heavily wrinkled or curled originals
- Transparent originals such as OHP film
- Originals with carbon paper on the back

- Originals with wet ink
- Originals with sticky notes attached

Note:

- Do not feed photos, valuable original artwork, or important documents which you do not want to damage or deface into the scanner directly. Misfeeding may wrinkle or damage the original. When scanning such originals, make sure you use the Carrier Sheet (sold separately).*
- Rippled, wrinkled, or curled originals can also be scanned if you use the Carrier Sheet (sold separately).*

Related Information

- ➔ [“Photographs” on page 51](#)

Placing Originals

Standard Size Originals

Specifications of Standard Size Originals

The list of the standard size originals you can load on the scanner.

Size	Measurement	Thickness	Paper Type	Loading Capacity *
Legal	215.9×355.6 mm (8.5×14 in.)	27 to 413 g/m ²	Plain paper Fine paper Recycled paper	Thickness of the originals stack: under 12 mm (0.47 in.) 80 g/m ² : 80 sheets 90 g/m ² : 69 sheets 104 g/m ² : 59 sheets 127 g/m ² : 50 sheets 157 g/m ² : 40 sheets 209 g/m ² : 30 sheets 256 g/m ² : 24 sheets 413 g/m ² : 14 sheets The loading capacity varies depending on the paper type.
Letter	215.9×279.4 mm (8.5×11 in.)			Thickness of the originals stack: under 12 mm (0.47 in.)
A4	210×297 mm (8.3×11.7 in.)			80 g/m ² : 100 sheets 90 g/m ² : 86 sheets
B5	182×257 mm (7.2×10.1 in.)			104 g/m ² : 74 sheets 127 g/m ² : 62 sheets
A5	148×210 mm (5.8×8.3 in.)			157 g/m ² : 50 sheets 209 g/m ² : 38 sheets
B6	128×182 mm (5.0×7.2 in.)			256 g/m ² : 30 sheets 413 g/m ² : 18 sheets
A6	105×148 mm (4.1×5.8 in.)			The loading capacity varies depending on the paper type.
A8	52×74 mm (2.1×2.9 in.)	127 to 413 g/m ²		
Business Card	55×89 mm (2.1×3.4 in.)	210 g/m ²		Thickness of the originals stack: under 12 mm (0.47 in.) 30 sheets

* You can refill the originals up to the maximum capacity during scanning.

Placing Standard Size Originals

1. Extend the input tray extension. Slide out the output tray, extend the output tray extension, and then raise the stopper.

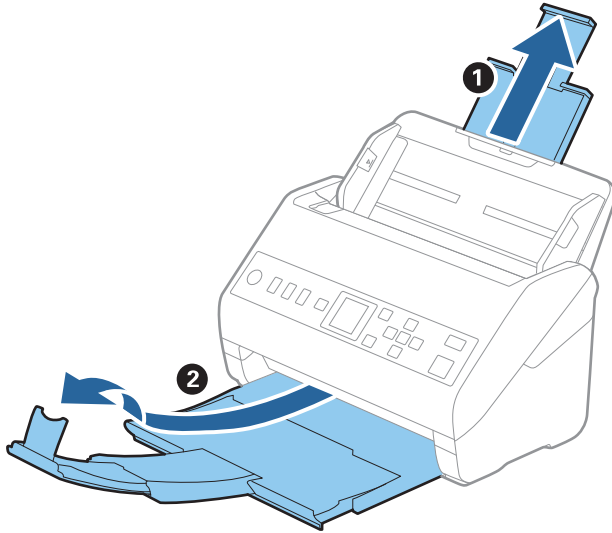

Note:

- For A4 size or larger originals, make sure you pull out and extend the input tray extension.
- Make sure you pull out and extend the output tray extensions so that they are a little bit longer than the length of the original, and raise the stopper so that the ejected originals can be stacked comfortably on the output tray.
- The stopper can move forward and backward on the output tray extension so that you can easily adjust the stopper position to the best position for the originals being scanned.
- If thick originals bump into the output tray and fall from it, store the output tray and do not use it to stack the ejected originals.
- If scanned images are still affected by ejected originals hitting the surface below the scanner, we recommend placing the scanner on the edge of a table where the ejected originals can drop freely and you can catch them.

2. Slide the edge guides on the input tray all the way out.

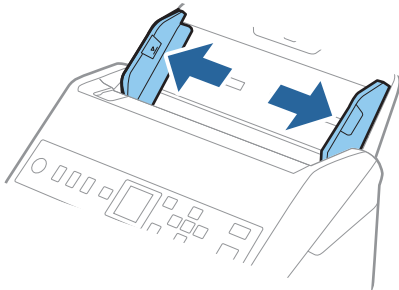

3. Fan the originals.

Hold both ends of the originals and fan them a few times.

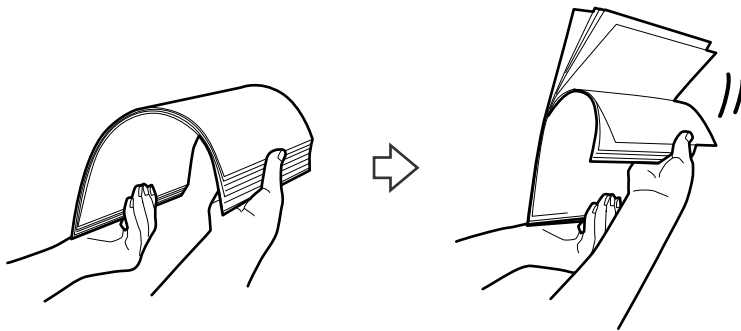

4. Align the edges of the originals with the printed side facing down and slide the leading edge into a wedge shape.

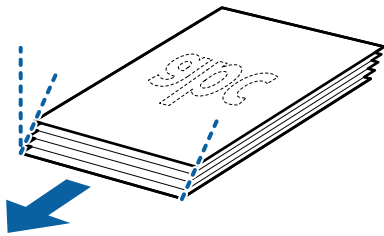

5. Load the originals into the input tray facing down with the top edge facing into the ADF. Slide the originals into the ADF until they meet resistance.

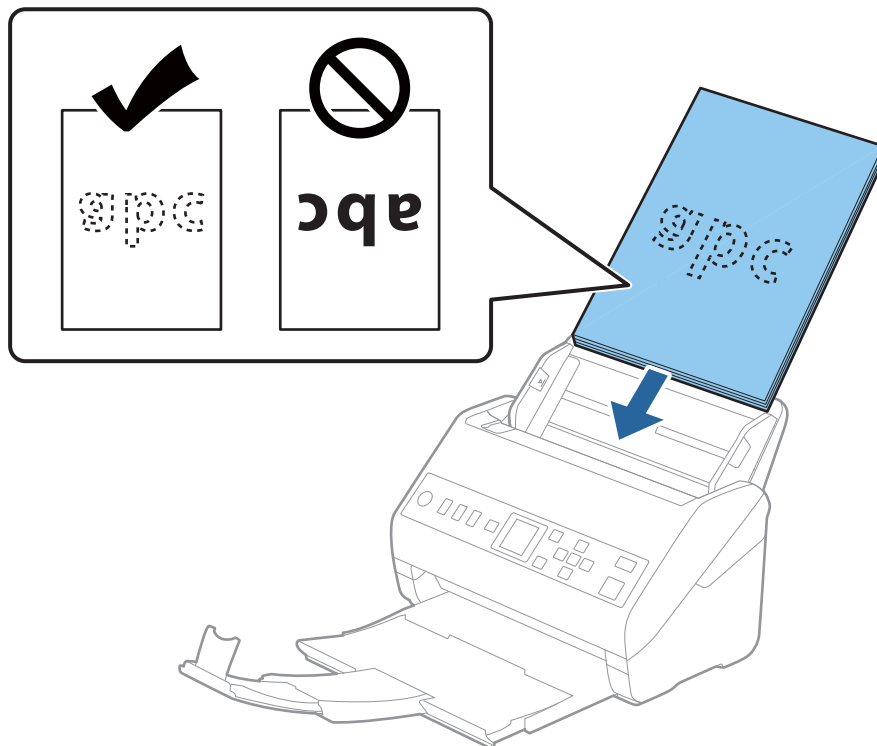

- Slide the edge guides to fit the edge of the originals making sure there are no gaps between the originals and the edge guides. Otherwise, the originals may be fed skewed.

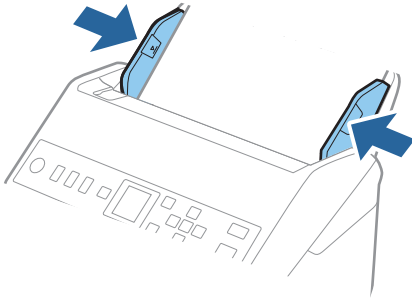

Note:

- When scanning originals with punch holes such as loose leaf paper, load the originals with the holes facing to the side or facing down. There must not be any holes within a 30 mm (1.2 inches) strip at the center of the originals. However, there can be holes within 30 mm (1.2 inches) from the leading edge of the originals. Make sure that the edges of the punch holes do not have burrs or curls.

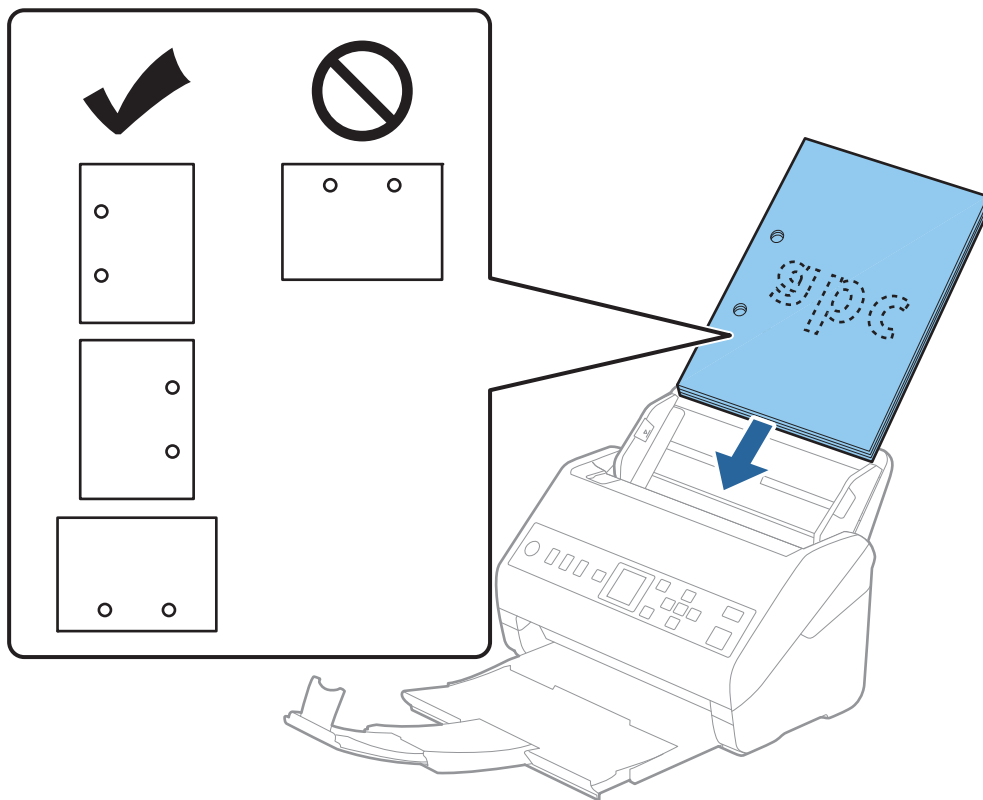

- When scanning thin paper with crinkles that are causing paper jams or double feeds, you may be able to improve the situation by enabling **Slow**. To do this, select **Settings > Scanner Settings > Slow** on the control panel and set it to **On** to slow down the feeding speed.

Long Paper

Specifications of Long Paper

The specification of long paper you can load into the scanner.

Size	Thickness	Paper Type	Loading Capacity
Maximum width: 215.9 mm (8.5 in.) Maximum length: 6,096.0 mm (240.0 in.)*	50 to 130 g/m ²	Plain paper Fine paper Recycled paper	1 sheet

*The following shows the maximum lengths according to the scanning resolution.

- 50 to 200 dpi : 6,096.0 mm (240.0 in.)
- 201 to 300 dpi : 5,461.0 mm (215.0 in.)
- 301 to 600 dpi : 1,346.0 mm (53.0 in.)

Placing Long Paper

1. Slide out the output tray.

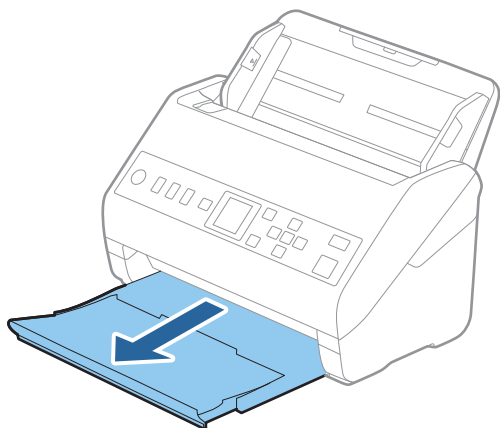

Note:

Do not extend the input tray extension and output tray extensions and do not raise the stopper.

- Slide the edge guides on the input tray all the way out.

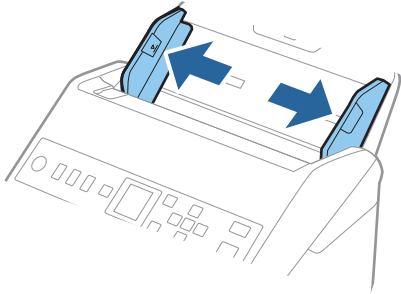

- Load the original straight into the input tray, facing down with the top edge facing into the ADF. Slide the original into the ADF until it meets resistance.

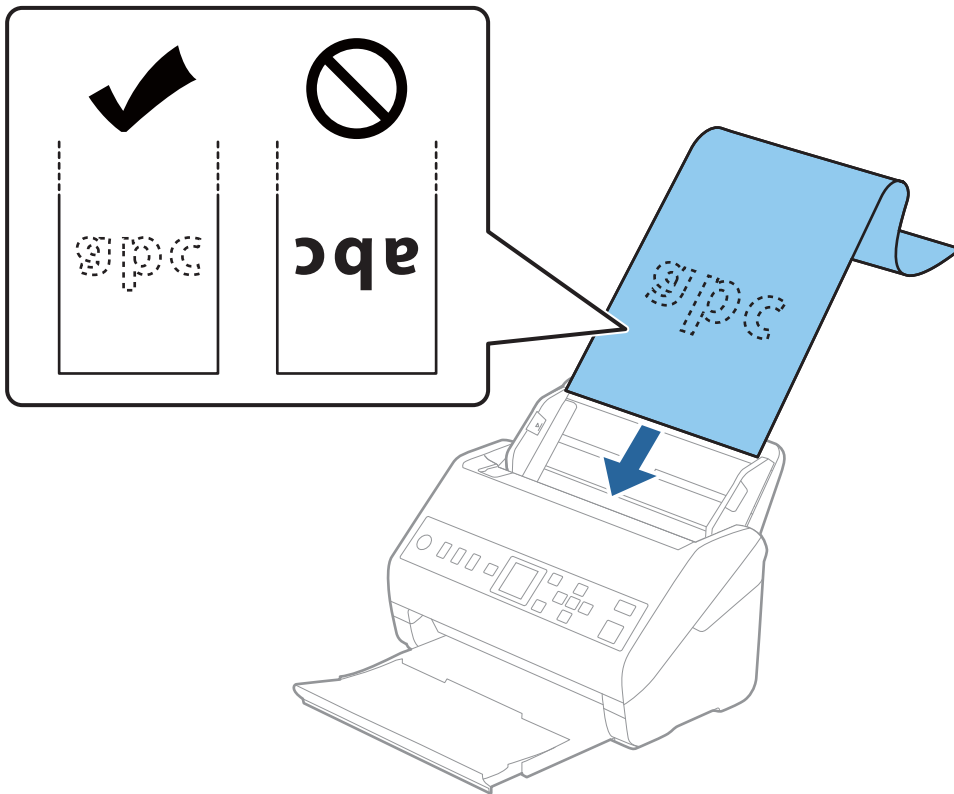

4. Adjust the edge guides to fit the edge of the long paper making sure there are no gaps between the edge of the paper and the edge guides. Otherwise, the originals may be fed skewed.

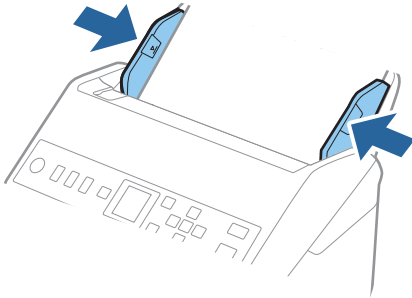

Note:

- ❑ The following shows the maximum lengths according to the scanning resolution.

- 50 to 200dpi : 6,096.0 mm (240.0 in.)
- 201 to 300dpi : 5,461.0 mm (215.0 in.)
- 301 to 600dpi : 1,346.0 mm (53.0 in.)

- ❑ You need to specify the paper size in the Epson Scan 2 window.

When you are using Document Capture Pro, you can open the window by pressing the **Detailed Settings** button on the **Scan Settings** screen.

There are three ways to specify the paper size in the Epson Scan 2 window.

If the paper length is 3,048 mm (120 inches) or less, you can select **Auto Detect (Long Paper)** to detect the size automatically.

If the paper length is more than 3,048 mm (120 inches), you need to select **Customize** and enter the size of the paper.

If the paper length is 5,461 mm (215 inches) or less, you can use **Detect paper length** instead of entering the paper height. If the paper is longer than 5,461 mm (215 inches), you need to enter the width and height of the paper.

- ❑ Support long paper at the input side so that it does not drop out of the ADF, and on the output side so that the ejected paper does not fall from the output tray.

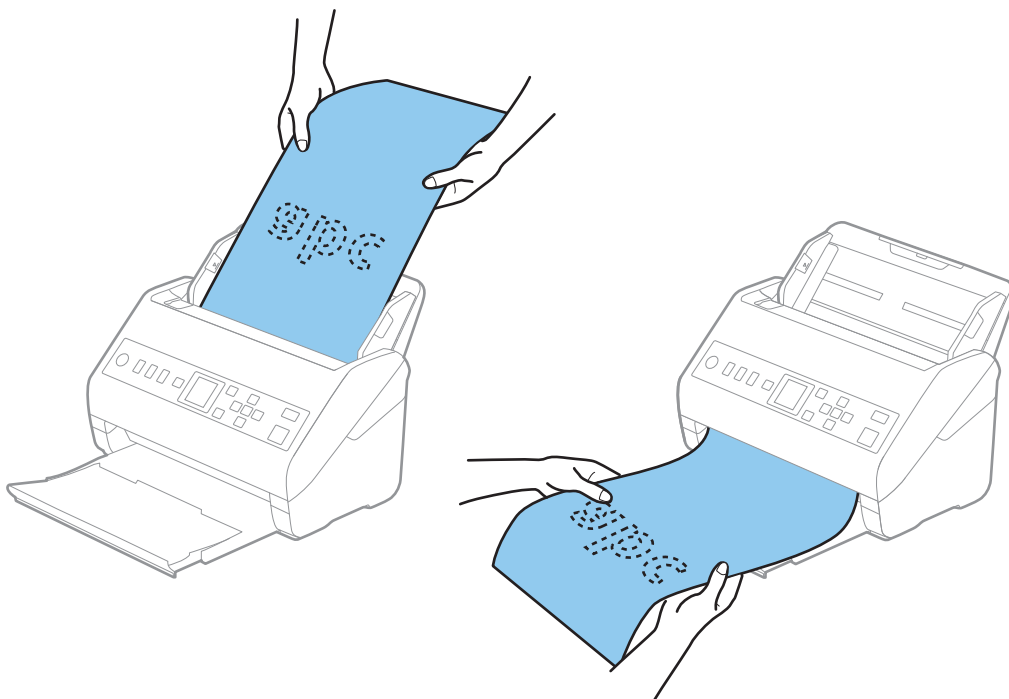

Related Information

➔ [“Required Settings for Special Originals in Epson Scan 2 Window” on page 112](#)

Plastic Cards

Specifications of Plastic Cards

The specification of plastic card you can load into the scanner.

Size	Card Type	Thickness	Loading Capacity	Loading Direction
ISO7810 ID-1 Type 54.0×85.6 mm (2.1×3.3 in.)	With embossing	1.24 mm (0.05 in.) or less	1 card	Horizontal (Landscape)
	Without embossing	0.76 mm (0.03 in.) to 1.1 mm (0.04 in.) *	5 cards	
		Less than 0.76 mm (0.03 in.)	5 cards	

* You can scan these cards only when the resolution is 300 dpi or less, and disabling **Slow** mode.

Placing Plastic Cards

1. Slide out the output tray and raise the stopper.

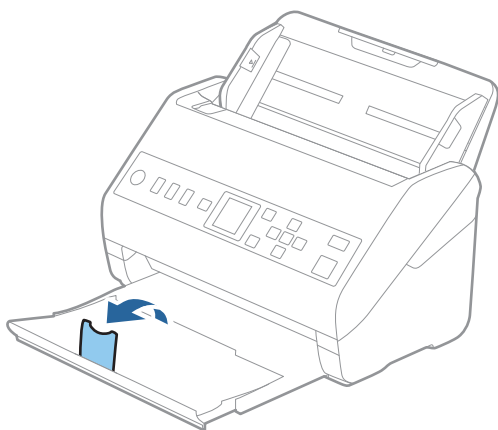

2. Slide the edge guides on the input tray all the way out.

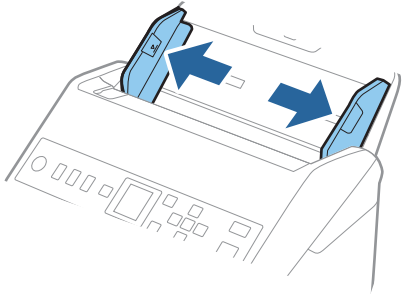

3. Load the plastic cards into the input tray facing down with the top edge facing into the ADF. Slide the plastic cards into the ADF until they meet resistance.

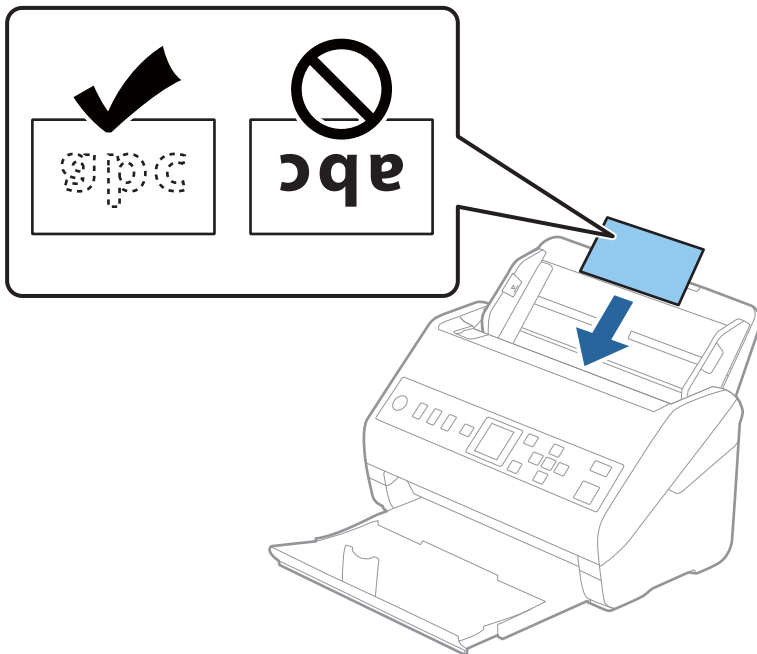

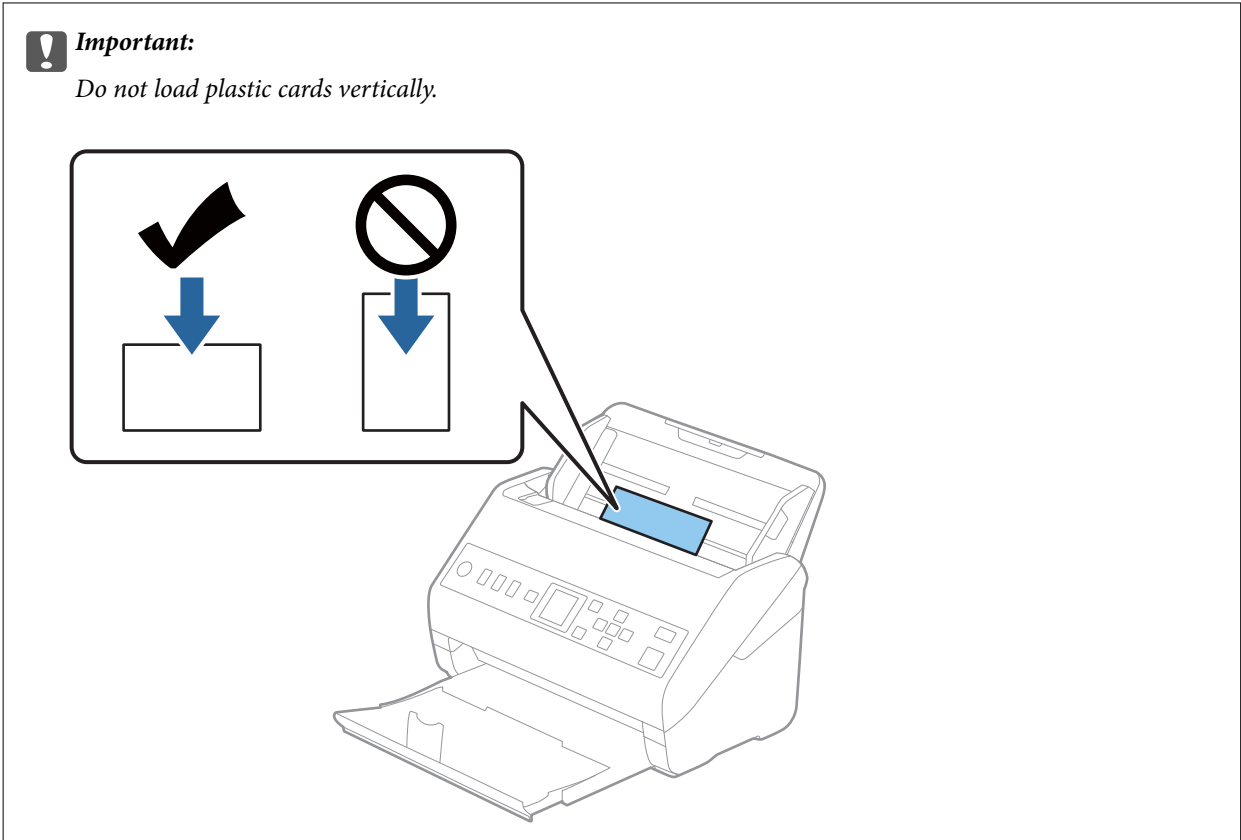

- Slide the edge guides to fit the edge of the plastic cards.

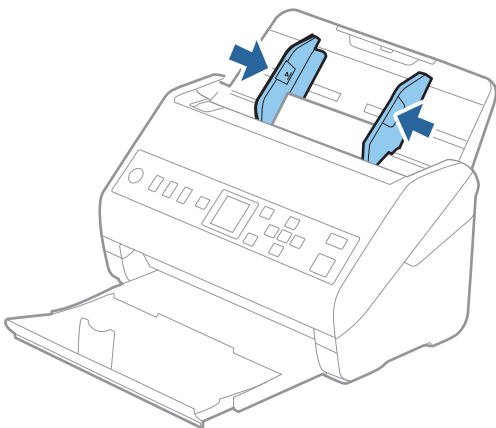

Note:

To scan plastic cards, set the appropriate setting in the Epson Scan 2 window.

When you are using Document Capture Pro, you can open the window by pressing the **Detailed Settings** button on the **Scan Settings** screen.

Select **Plastic Card** in **Document Size** or select **Off** in **Detect Double Feed** on the **Main Settings** tab in Epson Scan 2. See the Epson Scan 2 help for details.

If **Detect Double Feed** in the Epson Scan 2 window is enabled and a double feed error occurs, remove the card from the ADF, reload it, press the ▼ button, and then select **DFDS Function** (Double Feed Detection Skip function) on the control panel to set it to **On**. This disables **Detect Double Feed** for the next scan, and you can scan again. The **DFDS Function** only disables **Detect Double Feed** for one sheet.

Related Information

➔ [“Required Settings for Special Originals in Epson Scan 2 Window” on page 112](#)

Laminated Cards

Specifications of Laminated Cards

The specification of laminated cards you can load into the scanner.

Size	Thickness	Loading Capacity
120.0×150.0 mm (4.7×5.9 in.) or less	0.8 mm (0.03 in.) or less	1 card

Placing Laminated Cards

1. Slide out the output tray and raise the stopper.

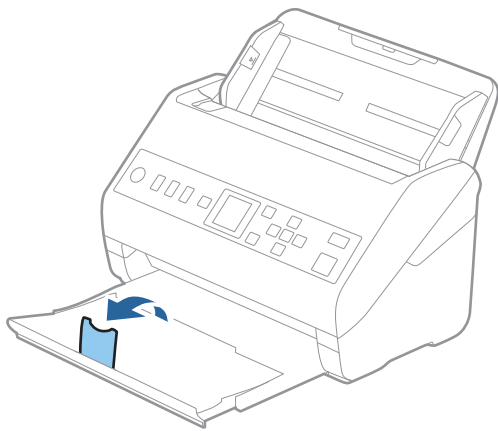

2. Slide the edge guides on the input tray all the way out.

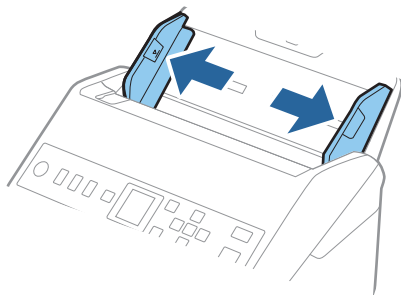

- Load the laminated cards into the input tray facing down with the top edge facing into the ADF. Slide the laminated cards into the ADF until they meet resistance.

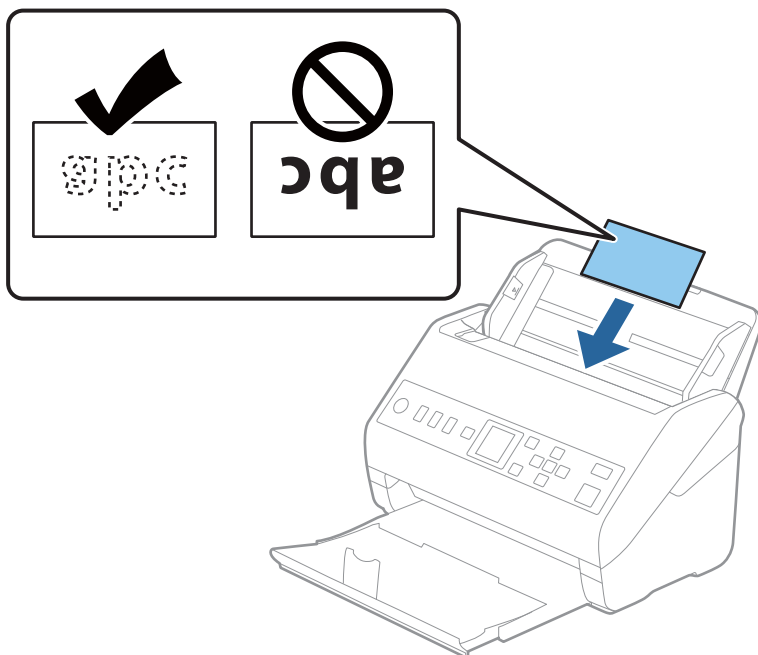

- Slide the edge guides to fit the edge of the laminated cards.

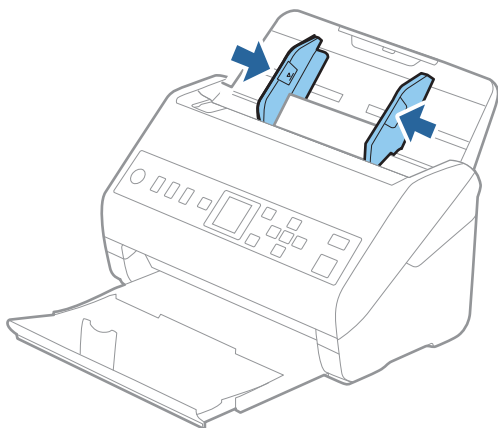

Note:

To scan laminated cards, set the appropriate setting in the Epson Scan 2 window.

When you are using Document Capture Pro, you can open the window by pressing the **Detailed Settings** button on the **Scan Settings** screen.

- To increase the accuracy of auto size detection, select the **Main Settings** tab > **Document Size** > **Settings** > **Scan laminated card**. See the Epson Scan 2 help for details.
- Select the **Main Settings** tab > **Detect Double Feed** > **Off**. See the Epson Scan 2 help for details.

If **Detect Double Feed** is enabled in the Epson Scan 2 window and a double feed error occurs, remove the card from the ADF, reload it, press the ▼ button, and then select **DFDS Function** (Double Feed Detection Skip function) on the control panel to set it to **On**. This disables **Detect Double Feed** for the next scan, and you can scan again. The **DFDS Function** only disables **Detect Double Feed** for one sheet.

Related Information

➔ [“Required Settings for Special Originals in Epson Scan 2 Window” on page 112](#)

Large Size Originals

Specifications of Large Size Originals

By using the Carrier Sheet sold separately and folding the originals in half, you can scan originals larger than A4 size, such as A3 or B4 sizes.

Size	Thickness	Paper Type	Loading Capacity of the Carrier Sheet
Up to A3	0.3 mm (0.012 in.) or less (excluding the thickness of the Carrier Sheet)	Plain paper Fine paper Recycled paper	10 carrier sheets

Placing Large Size Originals

1. Extend the input tray extension. Slide out the output tray, extend the output tray extension, and then raise the stopper.

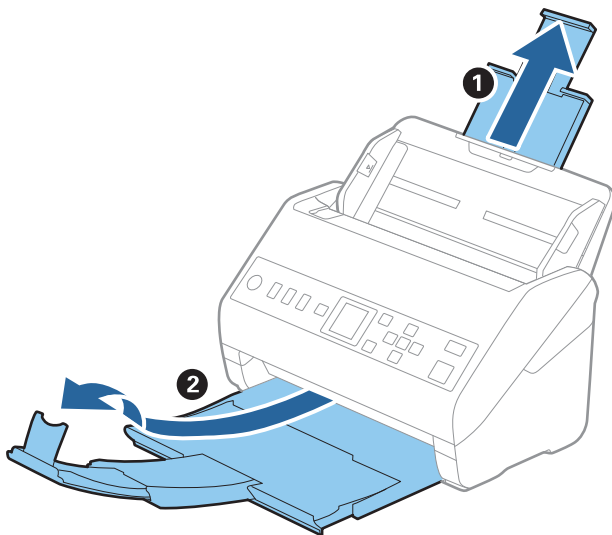

- Slide the edge guides on the input tray all the way out.

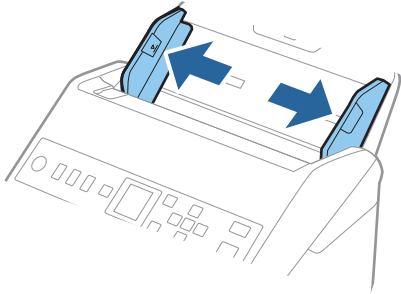

- Place the Carrier Sheet with the illustration on the front edge facing up and place the original in the carrier sheet by folding it in half so that the side to be scanned is facing out, with the right side at the front.

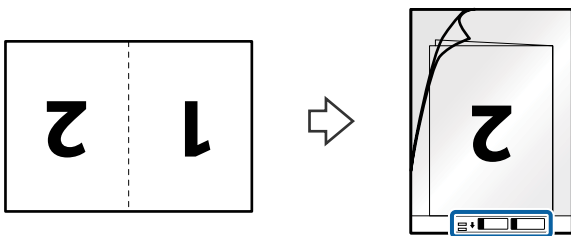

- Load the Carrier Sheet into the input tray with the top edge facing into the ADF. Slide the Carrier Sheet into the ADF until it meets resistance.

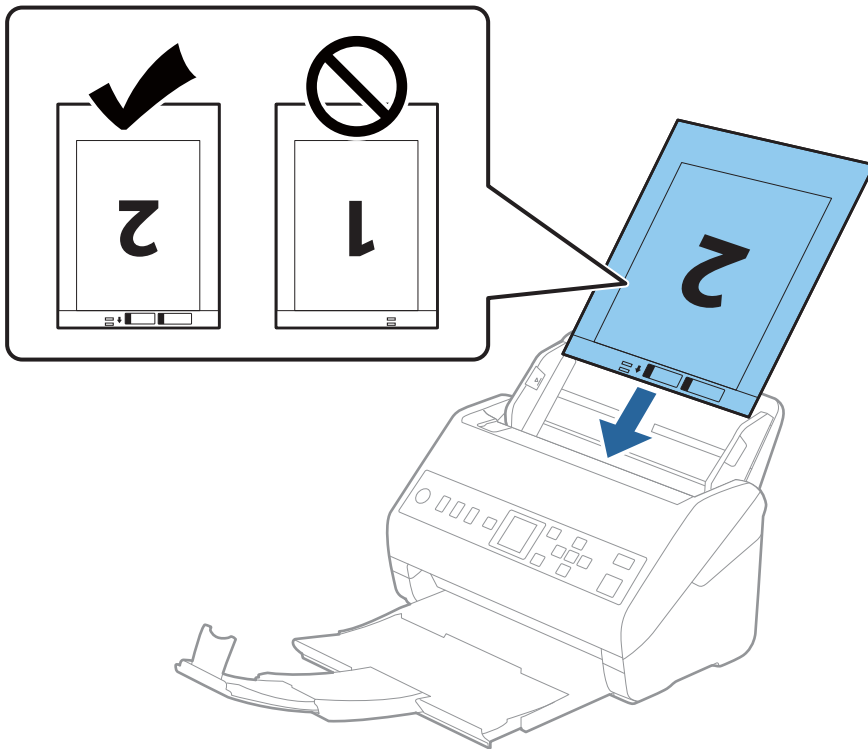

5. Slide the edge guides to fit the edge of the Carrier Sheet making sure there are no gaps between the Carrier Sheet and the edge guides. Otherwise, the carrier sheet may be fed skewed.

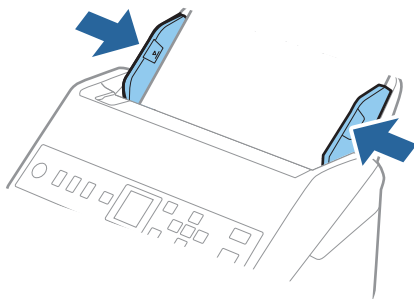

Note:

- You may need to stop using a Carrier Sheet that is scratched or has been scanned more than 3,000 times.
- To scan both sizes and stitch them together, set the appropriate setting in the Epson Scan 2 window.
When you are using Document Capture Pro, you can open the window by pressing the **Detailed Settings** button on the **Scan Settings** screen.
Select **Double-Sided** from **Scanning Side** and select **Left & Right** from **Stitch Images** in the Epson Scan 2 window. See the Epson Scan 2 help for details.
- When scanning a Carrier Sheet by selecting **Auto Detect** as the **Document Size** setting, the image is automatically scanned by applying **Paper Skew** in the **Correct Document Skew** setting.
- The leading edge of the original must be placed at the binding part of the Carrier Sheet when scanning an original approximately 297 mm long. Otherwise, the length of the scanned image may be longer than intended as the scanner scans to the end of the Carrier Sheet when you select **Auto Detect** as the **Document Size** setting in the Epson Scan 2 window.
- Only use the Carrier Sheet designed for your scanner. The Carrier Sheet is automatically recognized by the scanner by detecting two small rectangular holes on the front edge. Keep the holes clean and not covered.

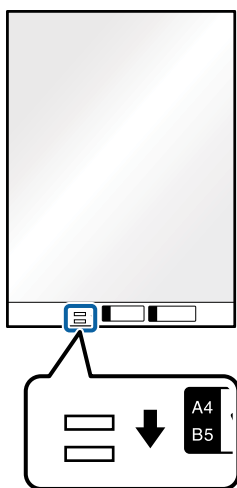

Related Information

- ➔ [“Carrier Sheet Codes” on page 25](#)
- ➔ [“Required Settings for Special Originals in Epson Scan 2 Window” on page 112](#)

Irregular Shaped Originals

Specifications of Irregular Shaped Originals

By using the Carrier Sheet sold separately, you can scan originals that are wrinkled, curled, very thin, or irregularly shaped.

Size	Thickness	Loading Capacity of the Carrier Sheet
Up to A4	0.3 mm (0.012 in.) or less (excluding the thickness of the Carrier Sheet)	10 sheets

Placing Irregular Shaped Originals

1. Extend the input tray extension. Slide out the output tray, extend the output tray extension, and then raise the stopper.

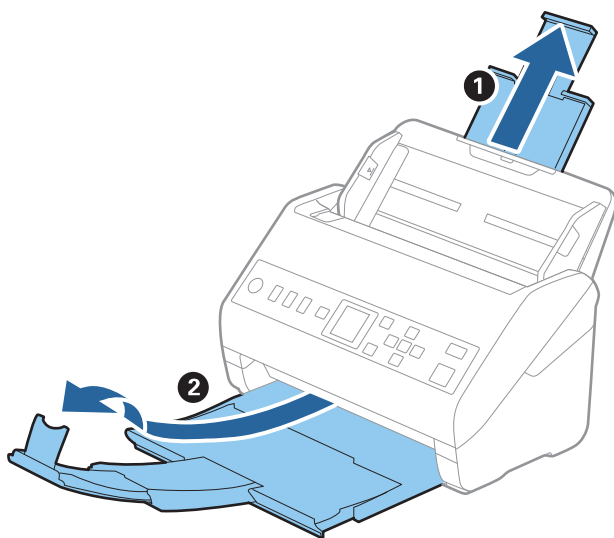

2. Slide the edge guides on the input tray all the way out.

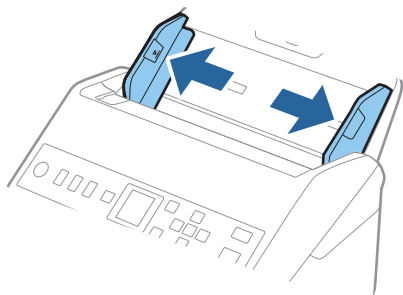

- Place the Carrier Sheet with the illustration on the front edge facing up and place the original in the center of the Carrier Sheet with the side to be scanned facing down.

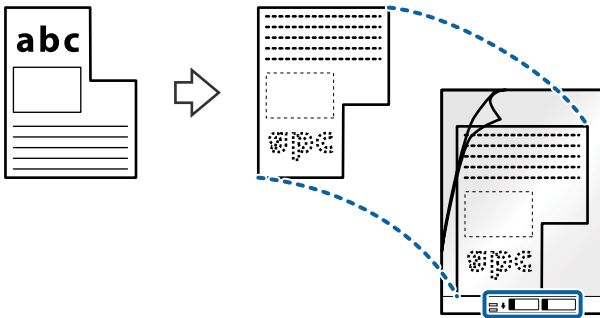

- Load the Carrier Sheet into the input tray with the top edge facing into the ADF. Slide the Carrier Sheet into the ADF until it meets resistance.

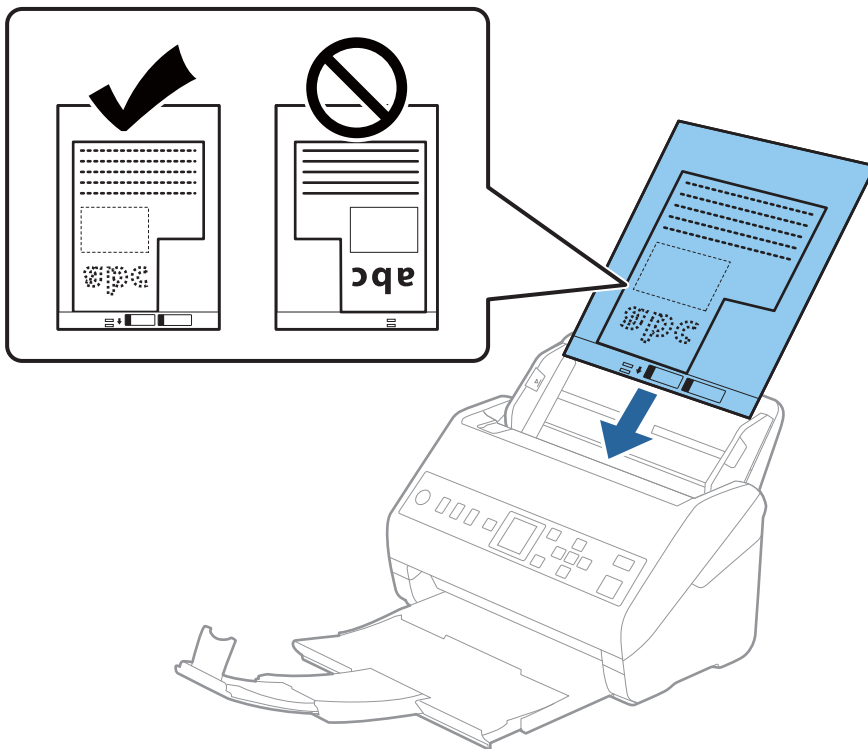

- Slide the edge guides to fit the edge of the Carrier Sheet making sure there are no gaps between the Carrier Sheet and the edge guides. Otherwise, the carrier sheet may be fed skewed.

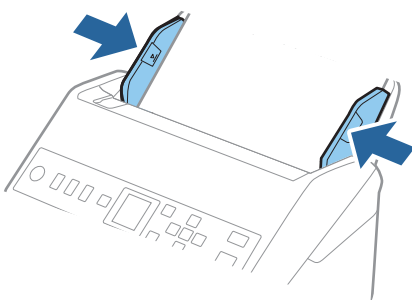

Note:

- ❑ You may need to stop using a Carrier Sheet that is scratched or has been scanned more than 3,000 times.
- ❑ If you cannot find an appropriate size for the original you want to scan in the **Document Size** list, select **Auto Detect**.
When using Epson Scan 2, you can also select **Customize** to create a custom document size.
- ❑ When scanning a Carrier Sheet by selecting **Auto Detect** as the **Document Size** setting, the image is automatically scanned by applying **Paper Skew** in the **Correct Document Skew** setting.
- ❑ Only use the Carrier Sheet designed for your scanner. The Carrier Sheet is automatically recognized by the scanner by detecting two small rectangular holes on the front edge. Keep the holes clean and not covered.

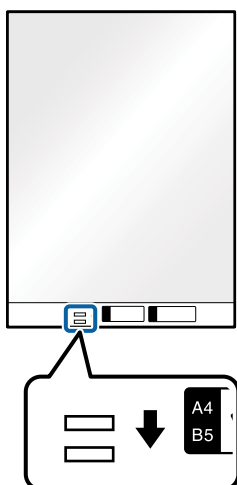

Related Information

- ➔ [“Carrier Sheet Codes” on page 25](#)
- ➔ [“Required Settings for Special Originals in Epson Scan 2 Window” on page 112](#)

Photographs

Specifications of Photographs

By using the Carrier Sheet sold separately, you can scan photographs without worrying about them being damaged.

Size	Thickness	Loading Capacity of the Carrier Sheet
Up to A4	0.3 mm (0.012 in.) or less (excluding the thickness of the Carrier Sheet)	10 sheets

Placing Photographs

1. Extend the input tray extension. Slide out the output tray, extend the output tray extension, and then raise the stopper.

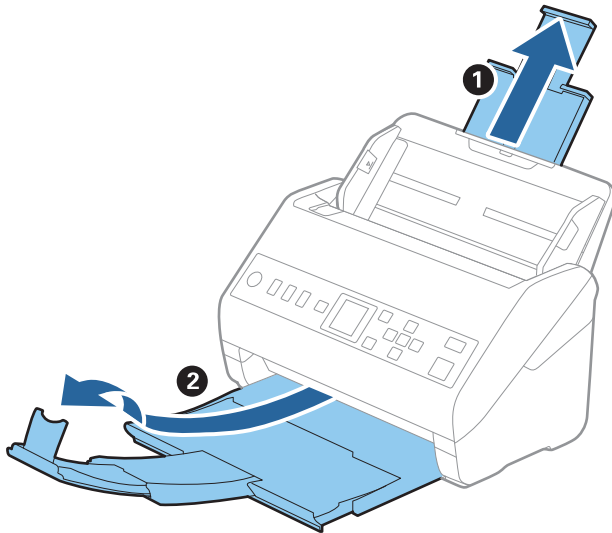

2. Slide the edge guides on the input tray all the way out.

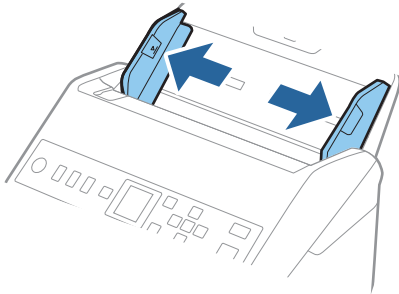

3. Place the Carrier Sheet with the illustration on the front edge facing up and place the photo in the center of the Carrier Sheet with the side to be scanned facing down.

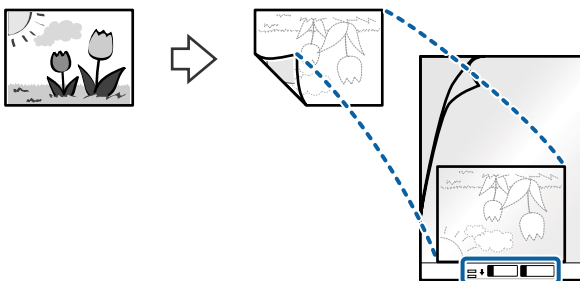

4. Load the Carrier Sheet into the input tray with the top edge facing into the ADF.
Slide the Carrier Sheet into the ADF until it meets resistance.

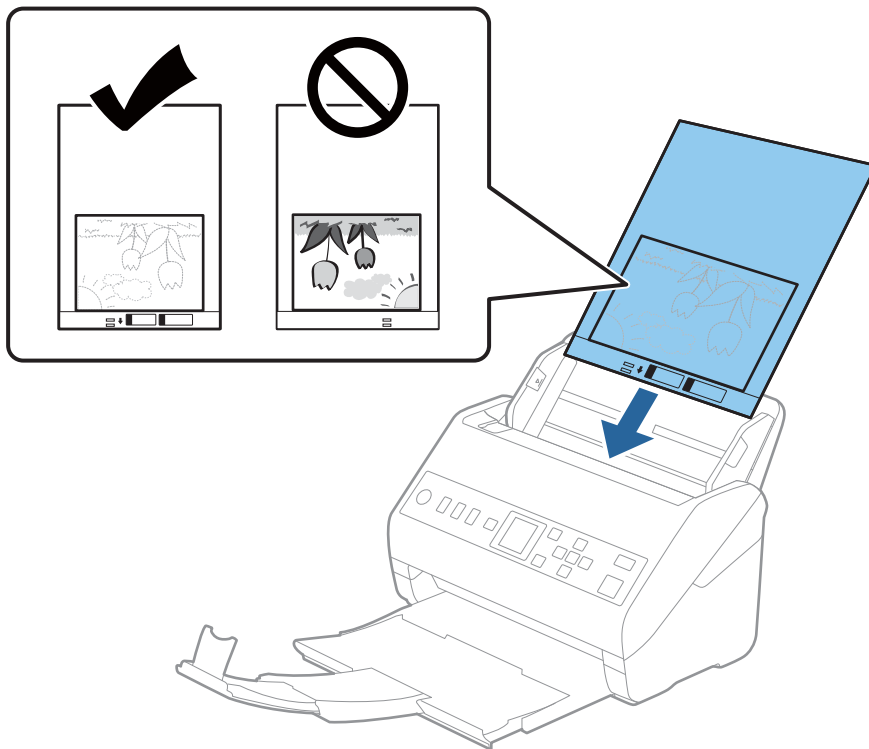

5. Slide the edge guides to fit the edge of the Carrier Sheet making sure there are no gaps between the Carrier Sheet and the edge guides. Otherwise, the carrier sheet may be fed skewed.

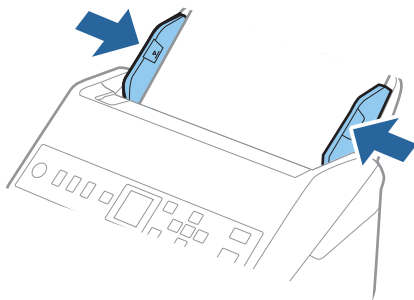

Note:

- ❑ You may need to stop using a Carrier Sheet that is scratched or has been scanned more than 3,000 times.
- ❑ If you cannot find an appropriate size for the original you want to scan in the **Document Size** list, select **Auto Detect**.
When using Epson Scan 2, you can also select **Customize** to create a custom document size.
- ❑ When scanning a Carrier Sheet by selecting **Auto Detect** as the **Document Size** setting, the image is automatically scanned by applying **Paper Skew** in the **Correct Document Skew** setting.
- ❑ Do not leave photos inside the Carrier Sheet for a long time.
- ❑ Only use the Carrier Sheet designed for your scanner. The Carrier Sheet is automatically recognized by the scanner by detecting two small rectangular holes on the front edge. Keep the holes clean and not covered.

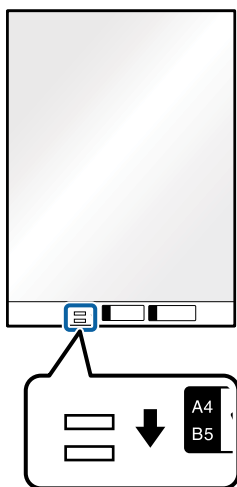

Related Information

- ➔ [“Carrier Sheet Codes” on page 25](#)
- ➔ [“Required Settings for Special Originals in Epson Scan 2 Window” on page 112](#)

Envelopes

Specifications of Envelopes

The specification of envelopes you can load into the scanner.

Size	Measurement	Thickness	Loading Capacity
C6	114×162 mm (4.49×6.38 in.) (standard size)	0.38 mm (0.015 in.) or less	10 envelopes
DL	110×220 mm (4.33×8.66 in.) (standard size)		

Placing Envelopes

1. Extend the input tray extension. Slide out the output tray, extend the output tray extension, and then raise the stopper.

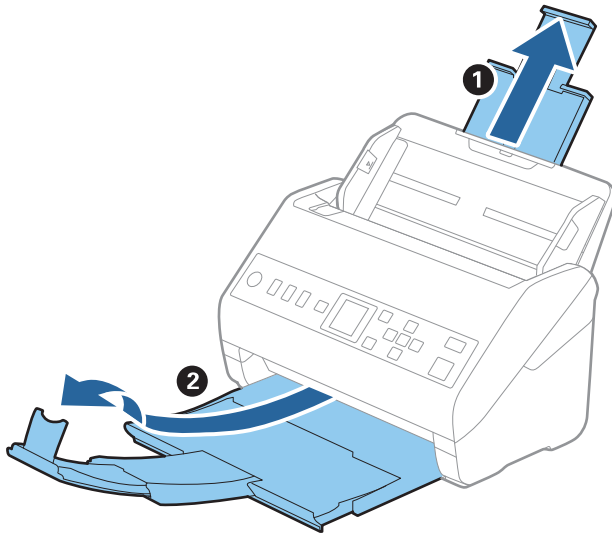

2. Slide the edge guides on the input tray all the way out.

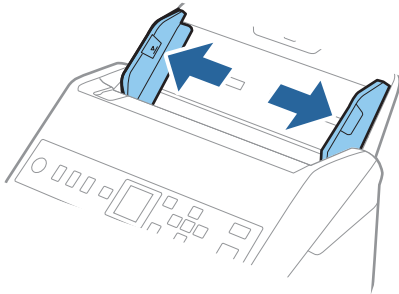

3. Load the envelopes into the input tray facing down making sure that the opened edge (flap side) of the envelope is facing to the side. For envelopes with the opened edge (flap side) on the shorter side, you can load the envelope with the opened edge (flap side) facing up.

Slide the envelopes into the ADF until they meet resistance.

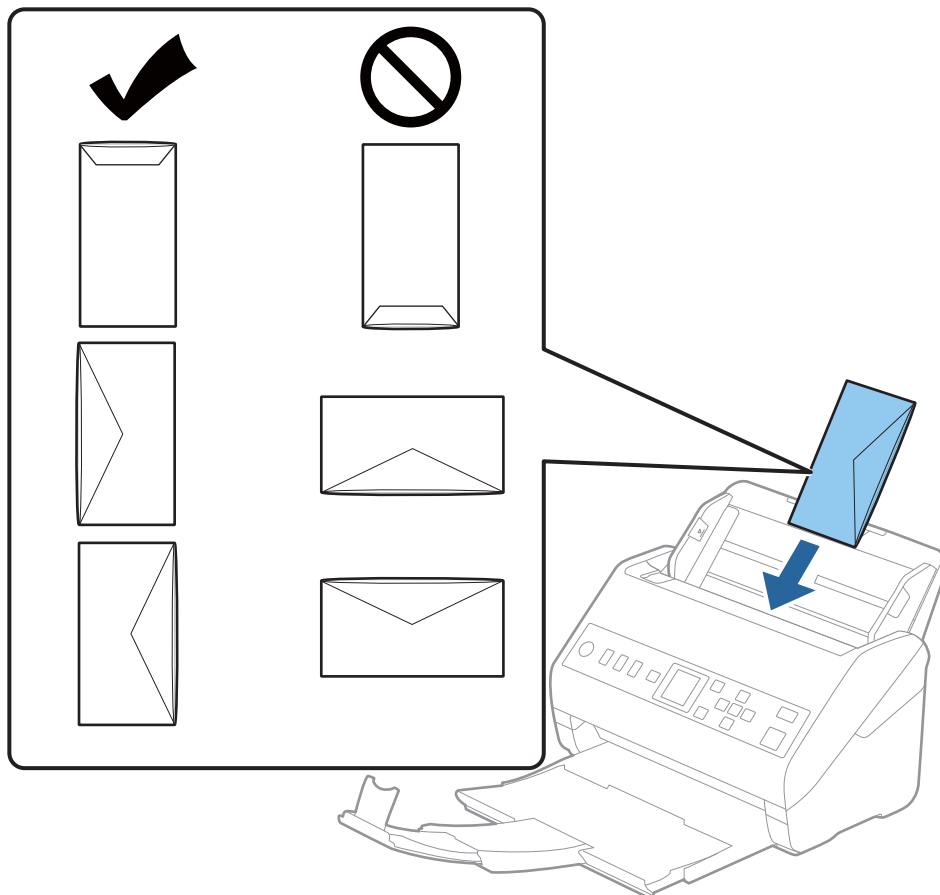

! *Important:*

Do not load envelopes with adhesives on them.

Note:

- Envelopes that are not opened by cutting sharply at the flap edge may not be scanned correctly.*
- Envelopes that have not yet been sealed can be loaded with the flap open and facing up.*

4. Slide the edge guides to fit the edge of the envelopes making sure there are no gaps between the envelopes and the edge guides. Otherwise, the envelopes may be fed skewed.

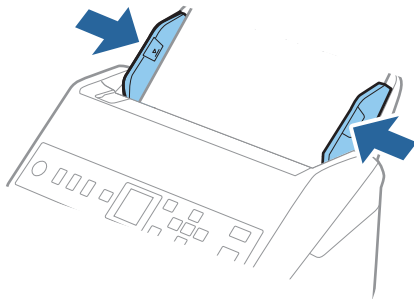

Note:

- ❑ We recommend selecting the appropriate rotation angle or **Auto** as the **Rotate** setting in the application.
- ❑ To scan envelopes, set the appropriate setting in the Epson Scan 2 window.

When you are using Document Capture Pro, you can open the window by pressing the **Detailed Settings** button on the **Scan Settings** screen.

Select **Main Settings** tab > **Detect Double Feed** > **Off**. See the Epson Scan 2 help for details.

If **Detect Double Feed** is enabled in the Epson Scan 2 window and a double feed error occurs, remove the envelope from the ADF, reload it, press the ▼ button, and then select **DFDS Function** (Double Feed Detection Skip function) on the control panel to set it to **On**. This disables **Detect Double Feed** for the next scan, and you can scan again. The **DFDS Function** only disables **Detect Double Feed** for one sheet.

Related Information

➔ [“Required Settings for Special Originals in Epson Scan 2 Window” on page 112](#)

Mixture of Originals

Specifications of Originals that are a Mixture of Different Sizes

You can load a mixture of originals from 50.8×50.8 mm (2.0×2.0 in.) to A4 (or Letter) size. You can also load a mixture of paper types or thickness.

Important:

- ❑ When placing and scanning originals that are a mixture of different sizes, originals may be fed askew because not all of the originals are supported by edge guides.
- ❑ Originals may be jammed or fed askew if you set different types or very different sizes of originals, such as in the following cases.

- Thin paper and Thick paper
- A4 size paper and card size paper

If originals are fed askew, check whether or not the scanned image is available.

Note:

- ❑ If originals are jammed or are not fed correctly, enabling **Slow mode** may improve feeding.
- ❑ Alternatively, you can scan originals of different paper sizes and types by loading them one by one using **Automatic Feeding Mode**.

Placing a Mixture of Originals at Different Sizes

1. Extend the input tray extension. Slide out the output tray, extend the output tray extension, and then raise the stopper.

Note:

If there are any thick originals, to stop them from bumping into the output tray and falling out, store the output tray and do not use it to stack the ejected originals.

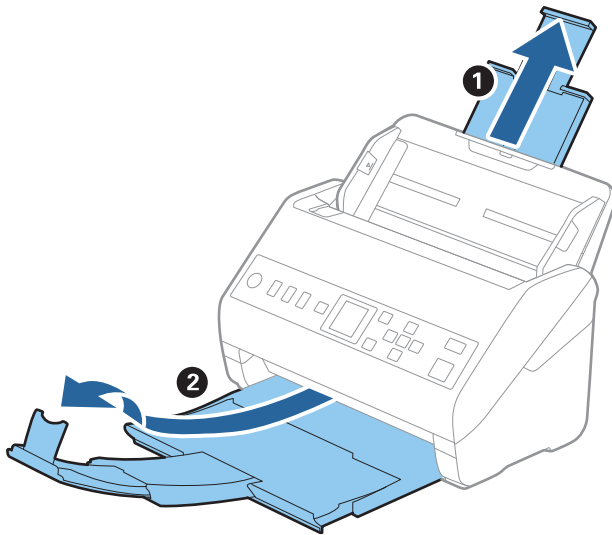

2. Slide the edge guides on the input tray all the way out.

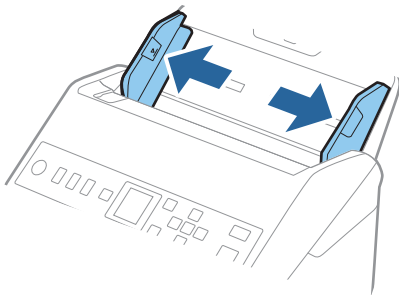

3. Load the originals at the center of the input tray in descending order of paper size with the widest at the back and the narrowest at the front.

! **Important:**

Check the following points when setting different sizes of originals.

- Slide the originals with their leading edges aligned, until they meet resistance in the ADF.
- Set the originals at the center of the input tray. Refer to the ▲ mark on the scanner as your guide.
- Set the originals straight.

If not, originals may be fed askew or jammed.

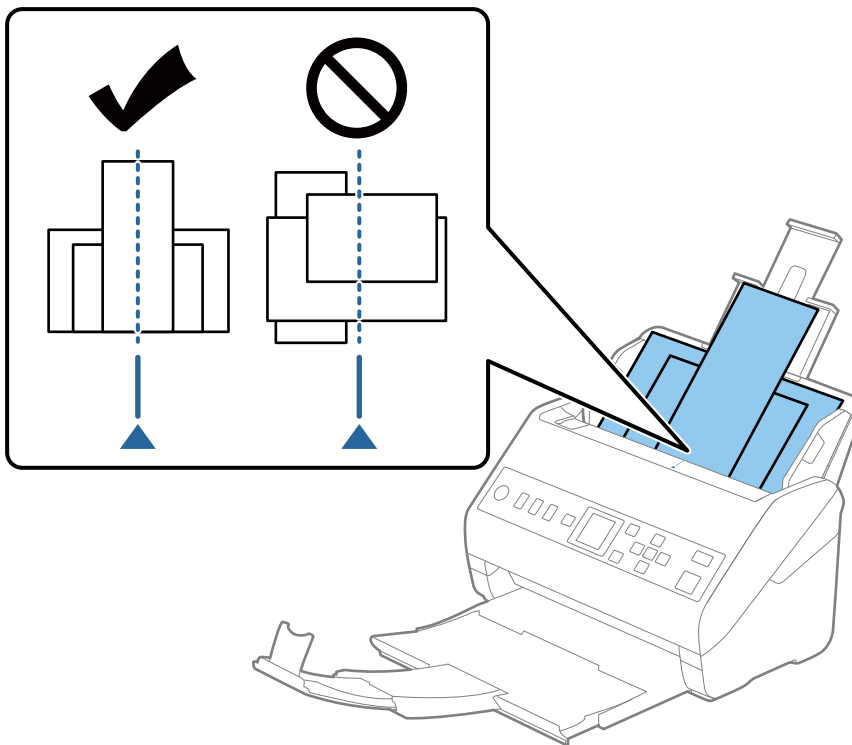

Note:

Load the originals into the input tray facing down and slightly displace the top edges at an angle facing into the ADF.

4. Slide the edge guides to fit the edges of the widest original.

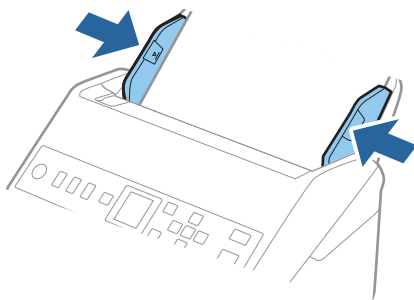

Related Information

➔ [“Scanning Different Sizes or Types of Originals One by One \(Automatic Feeding Mode\)” on page 124](#)

Preparing to Scan over a Network

Connecting the Scanner to the Network.	62
Configuring a Mail Server.	62
Setting a Shared Network Folder.	65
Making Contacts Available.	80
Using Document Capture Pro Server.	86
Registering Preset or Quick Send Buttons.	87

Connecting the Scanner to the Network

If the scanner is not connected to the network, use the installer to connect the scanner to the network.

You can use any of the following methods to start the installer.

- Setting up from the website

Access the following website, and then enter the product name. Go to **Setup**, and then start setting up.

<http://epson.sn>

- Setting up using the software disc (only for models that come with a software disc and users with Windows computers with disc drives.)

Insert the software disc into the computer, and then follow the on-screen instructions.

If you want to check the network connection or connect to the network manually, see the related information.

Related Information

➔ [“Checking the Network Connection Status” on page 207](#)

Configuring a Mail Server

Set the mail server from Web Config.

When the scanner can send the email by setting the mail server, the following are possible.

- Transfers the scan results by using email
- Receives the email notification from the scanner

Check below before setting up.

- The scanner is connected to the network that can access the mail server.
- Email setting information of the computer that uses the same mail server as the scanner.

Note:

When you use the mail server on the Internet, confirm the setting information from the provider or website.

1. Access Web Config and select the **Network** tab > **Email Server** > **Basic**.
2. Enter a value for each item.
3. Select **OK**.

The settings you have selected are displayed.

When the setup completes, perform the connection check.

Related Information

➔ [“Running Web Config on a Web Browser” on page 23](#)

Mail Server Setting Items

Items	Settings and Explanation	
Authentication Method	Specify the authentication method for the scanner to access the mail server.	
	Off	Authentication is disabled when communicating with a mail server.
	SMTP AUTH	Requires that a mail server supports SMTP Authentication.
	POP before SMTP	Configure the POP3 server when selecting this method.
Authenticated Account	If you select SMTP AUTH or POP before SMTP as the Authentication Method , enter the authenticated account name between 0 and 255 characters in ASCII (0x20-0x7E).	
Authenticated Password	If you select SMTP AUTH or POP before SMTP as the Authentication Method , enter the authenticated password between 0 and 20 characters in ASCII (0x20-0x7E).	
Sender's Email Address	Enter the sender's email address. Enter between 0 and 255 characters in ASCII (0x20-0x7E) except for : () < > [] ; ¥. A period "." cannot be the first character.	
SMTP Server Address	Enter between 0 and 255 characters using A-Z a-z 0-9 . - . You can use IPv4 or FQDN format.	
SMTP Server Port Number	Enter a number between 1 and 65535.	
Secure Connection	Specify the secure connection method for the email server.	
	None	If you select POP before SMTP in Authentication Method , the connection method is set to None .
	SSL/TLS	This is available when Authentication Method is set to Off or SMTP AUTH .
	STARTTLS	This is available when Authentication Method is set to Off or SMTP AUTH .
Certificate Validation	The certificate is validated when this is enabled. We recommend this is set to Enable .	
POP3 Server Address	If you select POP before SMTP as the Authentication Method , enter the POP3 server address between 0 and 255 characters using A-Z a-z 0-9 . - . You can use IPv4 or FQDN format.	
POP3 Server Port Number	If you select POP before SMTP as the Authentication Method , enter a number between 1 and 65535.	

Checking a Mail Server Connection

You can check the connection to the mail server by performing the connection check.

1. Access Web Config and select the **Network** tab > **Email Server** > **Connection Test**.
2. Select **Start**.

The connection test to the mail server is started. After the test, the check report is displayed.

Mail Server Connection Test References

Messages	Cause
Connection test was successful.	This message appears when the connection with the server is successful.
SMTP server communication error. Check the following. - Network Settings	This message appears when <ul style="list-style-type: none"> <input type="checkbox"/> The scanner is not connected to a network <input type="checkbox"/> SMTP server is down <input type="checkbox"/> Network connection is disconnected while communicating <input type="checkbox"/> Received incomplete data
POP3 server communication error. Check the following. - Network Settings	This message appears when <ul style="list-style-type: none"> <input type="checkbox"/> The scanner is not connected to a network <input type="checkbox"/> POP3 server is down <input type="checkbox"/> Network connection is disconnected while communicating <input type="checkbox"/> Received incomplete data
An error occurred while connecting to SMTP server. Check the followings. - SMTP Server Address - DNS Server	This message appears when <ul style="list-style-type: none"> <input type="checkbox"/> Connecting to a DNS server failed <input type="checkbox"/> Name resolution for an SMTP server failed
An error occurred while connecting to POP3 server. Check the followings. - POP3 Server Address - DNS Server	This message appears when <ul style="list-style-type: none"> <input type="checkbox"/> Connecting to a DNS server failed <input type="checkbox"/> Name resolution for an POP3 server failed
SMTP server authentication error. Check the followings. - Authentication Method - Authenticated Account - Authenticated Password	This message appears when SMTP server authentication failed.
POP3 server authentication error. Check the followings. - Authentication Method - Authenticated Account - Authenticated Password	This message appears when POP3 server authentication failed.
Unsupported communication method. Check the followings. - SMTP Server Address - SMTP Server Port Number	This message appears when you try to communicate with unsupported protocols.
Connection to SMTP server failed. Change Secure Connection to None.	This message appears when an SMTP mismatch occurs between a server and a client, or when the server does not support SMTP secure connection (SSL connection).
Connection to SMTP server failed. Change Secure Connection to SSL/TLS.	This message appears when an SMTP mismatch occurs between a server and a client, or when the server requests to use an SSL/TLS connection for an SMTP secure connection.
Connection to SMTP server failed. Change Secure Connection to STARTTLS.	This message appears when an SMTP mismatch occurs between a server and a client, or when the server requests to use an STARTTLS connection for an SMTP secure connection.
The connection is untrusted. Check the following. - Date and Time	This message appears when the scanner's date and time setting is incorrect or the certificate has expired.

Messages	Cause
The connection is untrusted. Check the following. - CA Certificate	This message appears when the scanner does not have a root certificate corresponding to the server or a CA Certificate has not been imported.
The connection is not secured.	This message appears when the obtained certificate is damaged.
SMTP server authentication failed. Change Authentication Method to SMTP-AUTH.	This message appears when an authentication method mismatch occurs between a server and a client. The server supports SMTP AUTH.
SMTP server authentication failed. Change Authentication Method to POP before SMTP.	This message appears when an authentication method mismatch occurs between a server and a client. The server does not support SMTP AUTH.
Sender's Email Address is incorrect. Change to the email address for your email service.	This message appears when the specified sender's Email address is wrong.
Cannot access the product until processing is complete.	This message appears when the scanner is busy.

Setting a Shared Network Folder

Set a shared network folder to save the scanned image.

When saving a file to the folder, the scanner logs on as the user of the computer on which the folder was created.

Creating the Shared Folder

Related Information

- ➔ [“Before Creating the Shared Folder” on page 65](#)
- ➔ [“Checking the Network Profile” on page 66](#)
- ➔ [“Location Where the Shared Folder is Created and an Example of the Security” on page 66](#)
- ➔ [“Adding Group or User Which Permits Access” on page 77](#)

Before Creating the Shared Folder

Before creating the shared folder, check the following.

- The scanner is connected to the network where it can access the computer where the shared folder will be created.
- A multi-byte character is not included in the name of the computer where the shared folder will be created.

 **Important:**

When a multi-byte character is included in the computer name, saving the file to the shared folder may fail.

In that case, change to the computer that does not include the Multi-byte character in the name or change the computer name.

When changing the computer name, make sure to confirm with the administrator in advance because it may affect some settings, such as computer management, resource access, etc.

Checking the Network Profile

On the computer where the shared folder will be created, check whether folder sharing is available.

1. Log in to the computer where the shared folder will be created by the administrator authority user account.
2. Select **Control Panel > Network and Internet > Network and Sharing Center**.
3. Click **Change advanced sharing settings**, and then click  for the profile with **(current profile)** in the displayed network profiles.
4. Check whether **Turn on file and printer sharing** is selected on **File and Printer Sharing**.
If already selected, click **Cancel** and close the window.
When you change the settings, click **Save Changes** and close the window.

Location Where the Shared Folder is Created and an Example of the Security

Depending on the location where the shared folder is created, security and convenience vary.

To operate the shared folder from the scanners or other computers, the following reading and changing permissions for the folder are required.

Sharing tab > Advanced Sharing > Permissions

It controls the network access permission of the shared folder.

Access permission of **Security** tab

It controls permission of the network access and local access of the shared folder.

When you set **Everyone** to the shared folder that is created on the desktop, as an example of creating a shared folder, all users who can access the computer will be permitted access.

However, the user who does not have authority cannot access them because the desktop (folder) is under the control of the user folder, and then the security settings of the user folder are handed down to it. The user who is permitted access on the **Security** tab (user logged in and administrator in this case) can operate the folder.

See below to create the proper location.

This example is when creating the "scan_folder" folder.

Related Information

- ➔ [“Example of Configuration for File Servers” on page 67](#)
- ➔ [“Example of Configuration for a Personal Computer” on page 72](#)

Example of Configuration for File Servers

This explanation is an example for creating the shared folder on the root of the drive on the shared computer, such as the file server under the following condition.

Access controllable users, such as someone who has the same domain of a computer to create a shared folder, can access the shared folder.

Set this configuration when you permit any user to read and write to the shared folder on the computer, such as the file server and the shared computer.

- Place for creating shared folder: Root of drive
- Folder path: C:\scan_folder
- Access permission via network (Share Permissions): Everyone
- Access permission on file system (Security): Authenticated Users

1. Log in to the computer where the shared folder will be created by the administrator authority user account.
2. Start explorer.
3. Create the folder on the root of drive, and then name it "scan_folder".

For the folder name, enter between 1 and 12 alphanumeric characters. If the character limit of the folder name is exceeded, you may not be able to access it normally by the varied environment.

4. Right click the folder, and then select **Properties**.

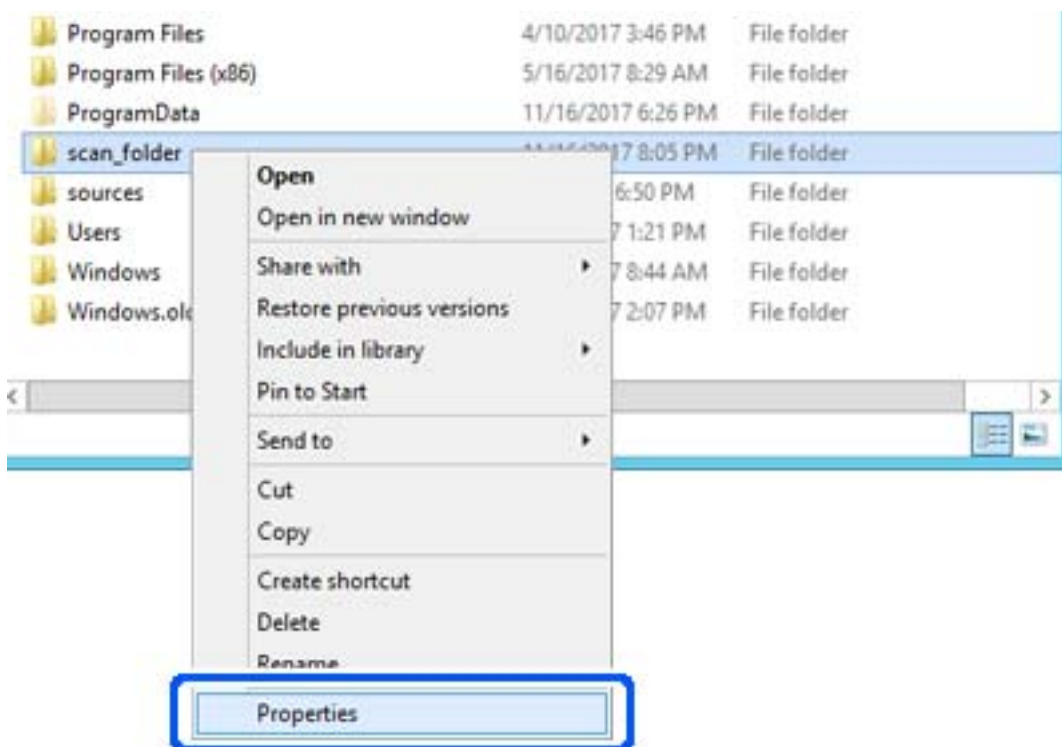

5. Click **Advanced Sharing** on the **Sharing** tab.

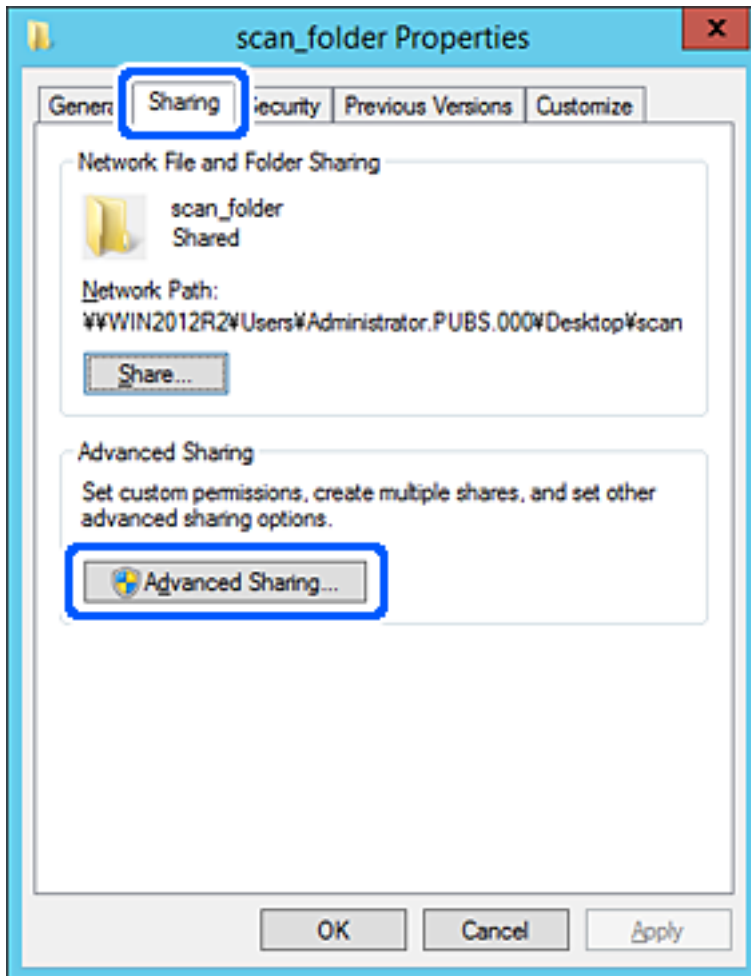

6. Select **Share this folder**, and then click **Permissions**.

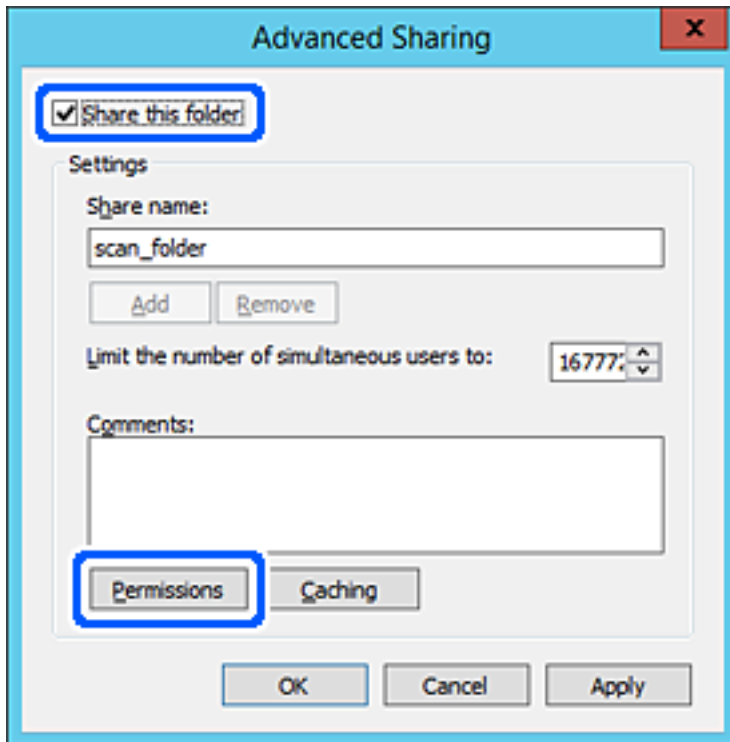

7. Select **Everyone** group of **Group or user names**, select **Allow** on **Change**, and then click **OK**.

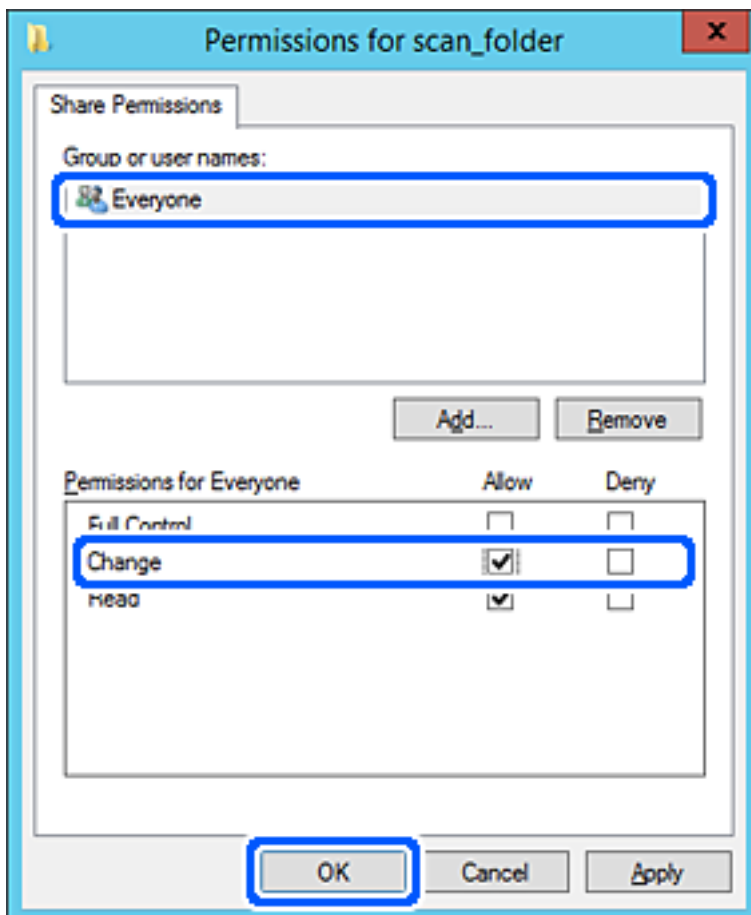

8. Click OK.
9. Select **Security** tab, and then select **Authenticated Users** on the **Group or user names**.

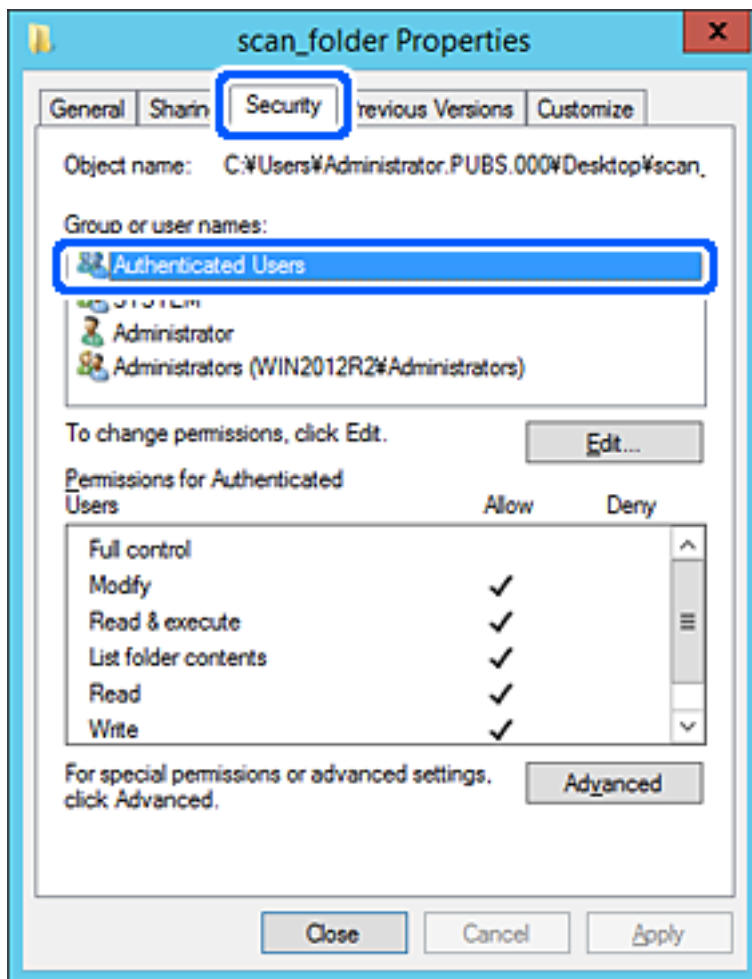

"Authenticated Users" is the special group that includes all users who can log in to the domain or computer. This group is displayed only when the folder is created just below the root folder.

If it is not displayed, you can add it by clicking **Edit**. For more details, see Related Information.

10. Check that **Allow** on **Modify** is selected in **Permissions for Authenticated Users**.

If it is not selected, select **Authenticated Users**, click **Edit**, select **Allow** on **Modify** in **Permissions for Authenticated Users**, and then click **OK**.

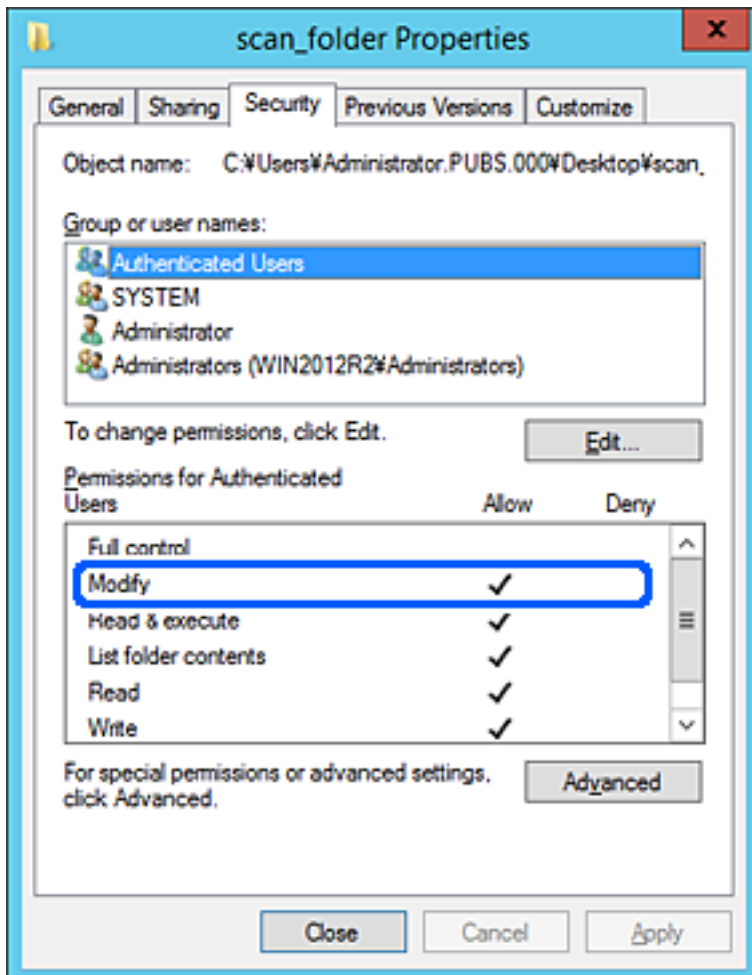

11. Select **Sharing** tab.

The network path of the shared folder is displayed. This is used when registering to the contacts of the scanner. Please write it down.

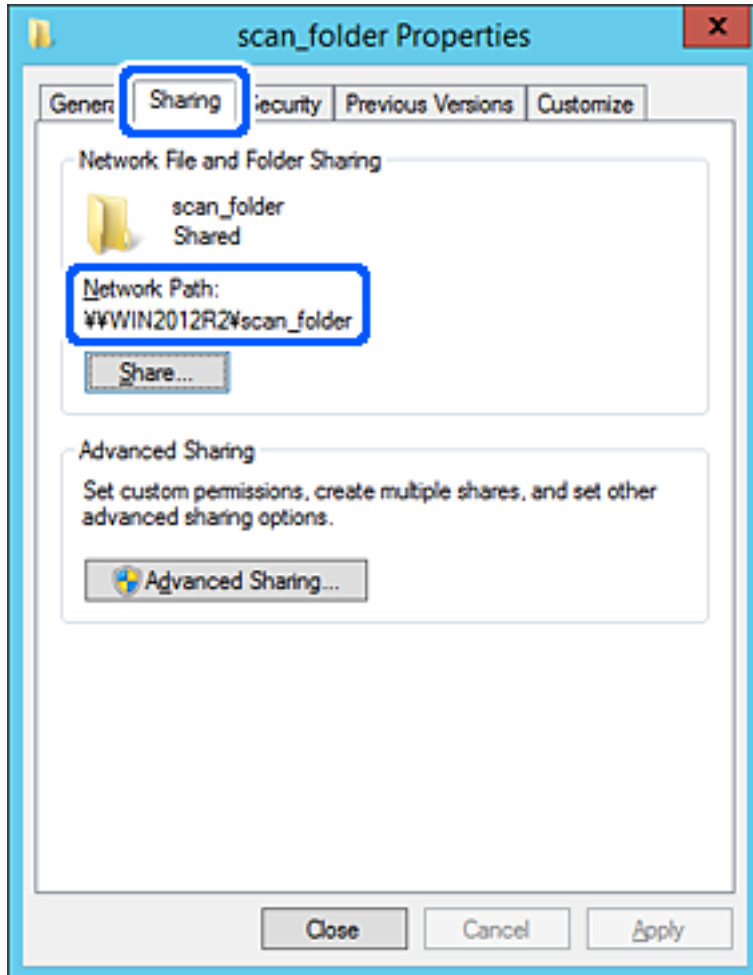

12. Click **OK** or **Close** to close the screen.

Check whether the file can be written or read on the shared folder from the computers of the same domain.

Related Information

- ➔ [“Adding Group or User Which Permits Access” on page 77](#)
- ➔ [“Registering a Destination to Contacts using Web Config” on page 81](#)

Example of Configuration for a Personal Computer

This explanation is an example for creating the shared folder on the desktop of the user currently logging in to the computer.

The user who logs in to the computer and who has administrator authority can access the desktop folder and the document folder that are under the User folder.

Set this configuration when you DO NOT permit reading and writing to another user to the shared folder on a personal computer.

- Place for creating shared folder: Desktop

- Folder path: C:\Users\xxxx\Desktop\scan_folder
- Access permission via network (Share Permissions): Everyone
- Access permission on file system (Security): do not add, or add User/Group names to permit access

1. Log in to the computer where the shared folder will be created by the administrator authority user account.
2. Start explorer.
3. Create the folder on the desktop, and then name it "scan_folder".

For the folder name, enter between 1 and 12 alphanumeric characters. If the character limit of the folder name is exceeded, you may not be able to access it normally by the varied environment.

4. Right click the folder, and then select **Properties**.

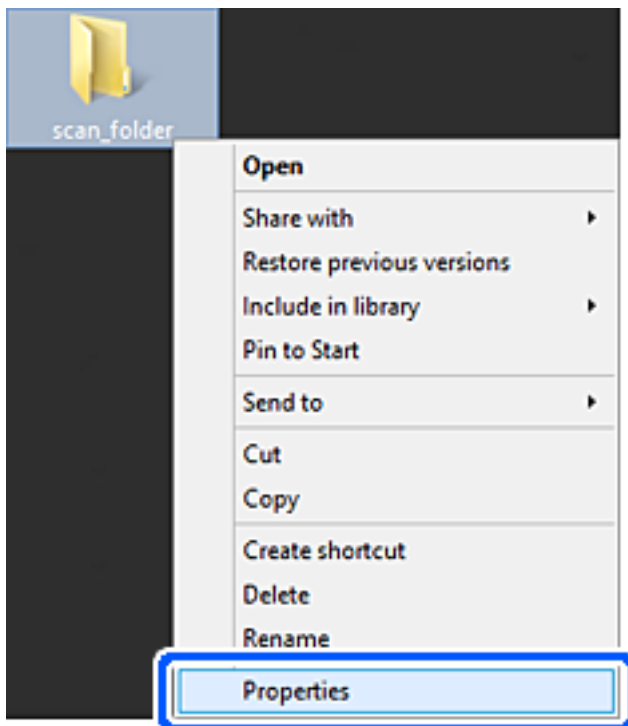

5. Click **Advanced Sharing** on the **Sharing** tab.

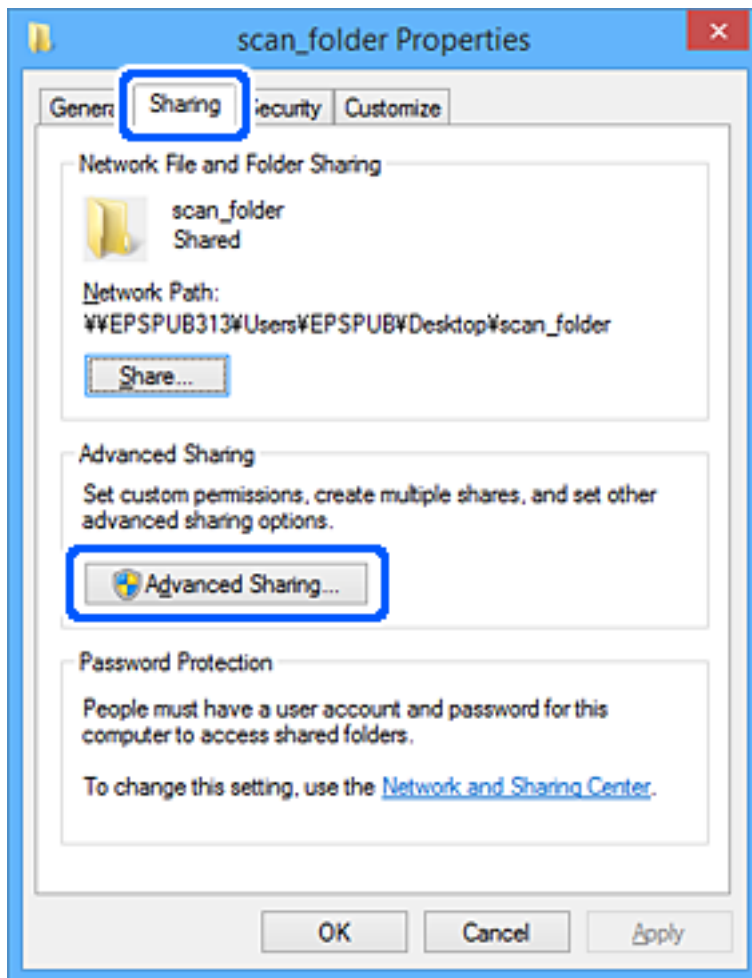

6. Select **Share this folder**, and then click **Permissions**.

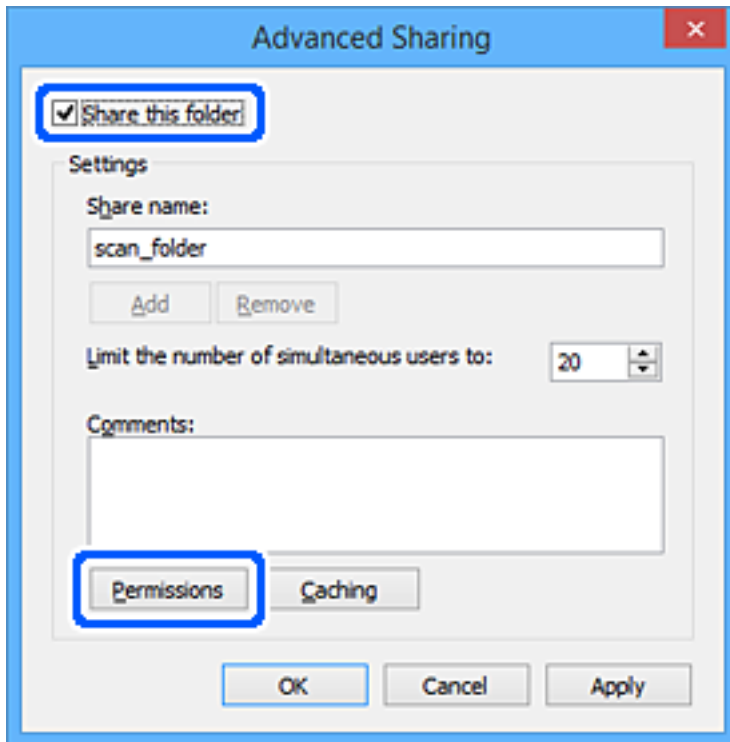

7. Select **Everyone** group of **Group or user names**, select **Allow** on **Change**, and then click **OK**.

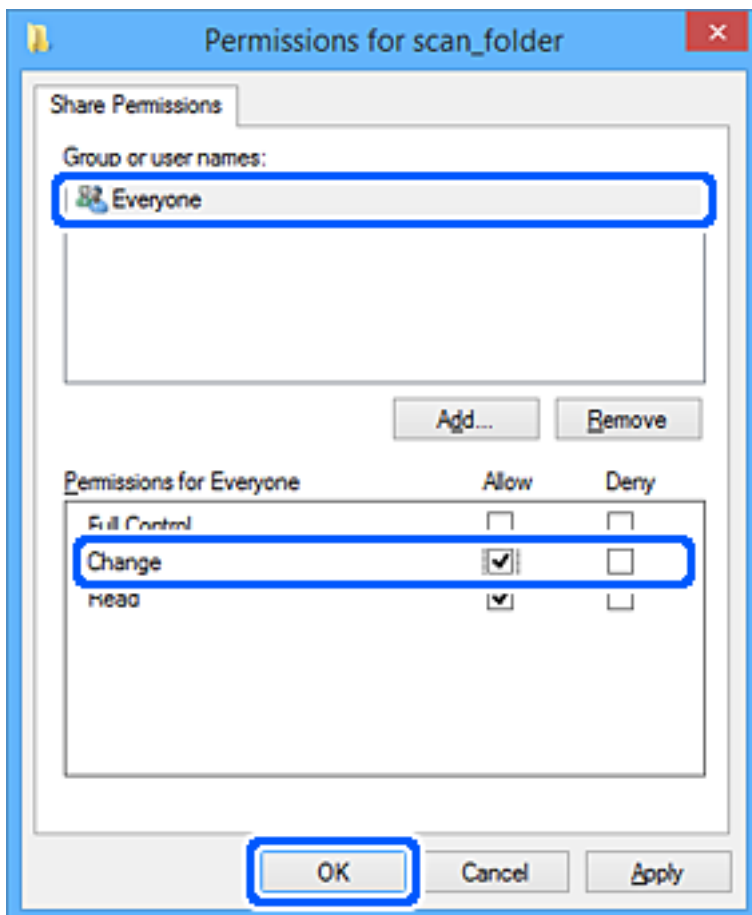

8. Click **OK**.
9. Select **Security** tab.
10. Check the group or the user in the **Group or user names**.

The group or the user that is displayed here can access the shared folder.

In this case, the user who logs in to this computer and the Administrator can access the shared folder.

Add access permission, if necessary. You can add it by clicking **Edit**. For more details, see Related Information.

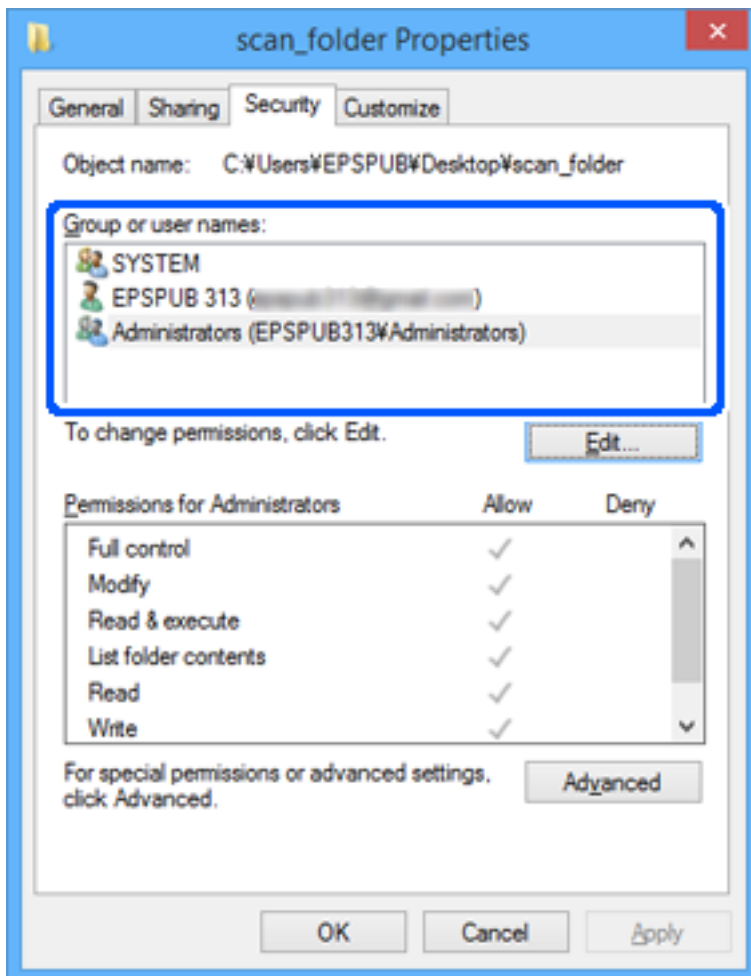

11. Select **Sharing** tab.

The network path of the shared folder is displayed. This is used when registering to the contacts of the scanner. Please write it down.

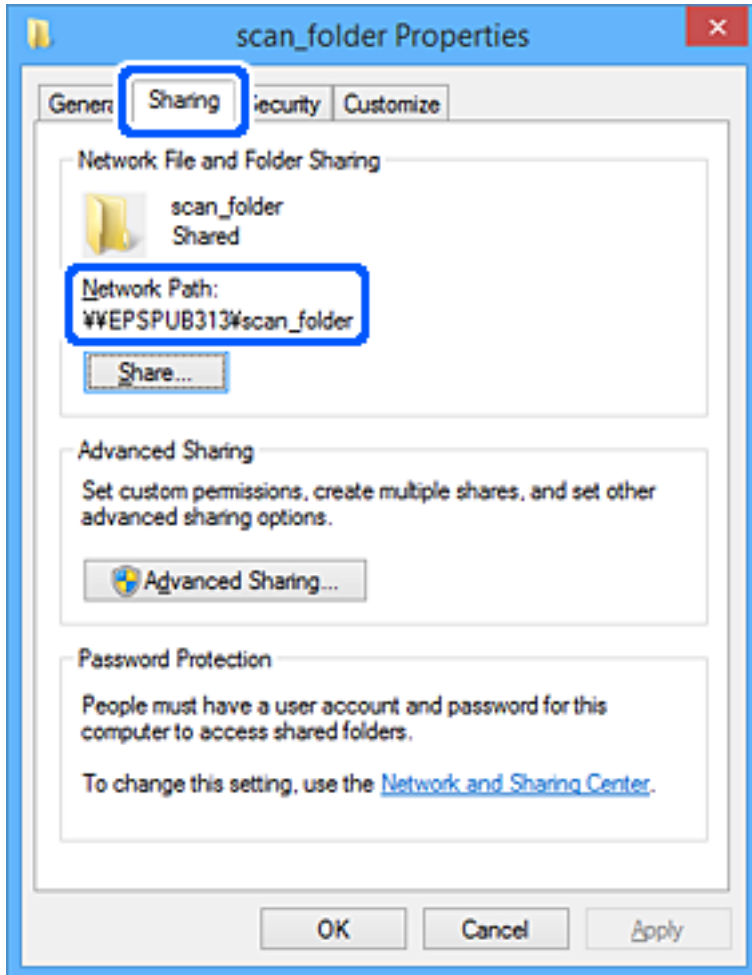

12. Click **OK** or **Close** to close the screen.

Check whether the file can be written or read on the shared folder from the computers of users or groups with access permission.

Related Information

- ➔ “Adding Group or User Which Permits Access” on page 77
- ➔ “Registering a Destination to Contacts using Web Config” on page 81

Adding Group or User Which Permits Access

You can add the group or user which permits access.

1. Right click the folder and select **Properties**.
2. Select **Security** tab.

3. Click Edit.

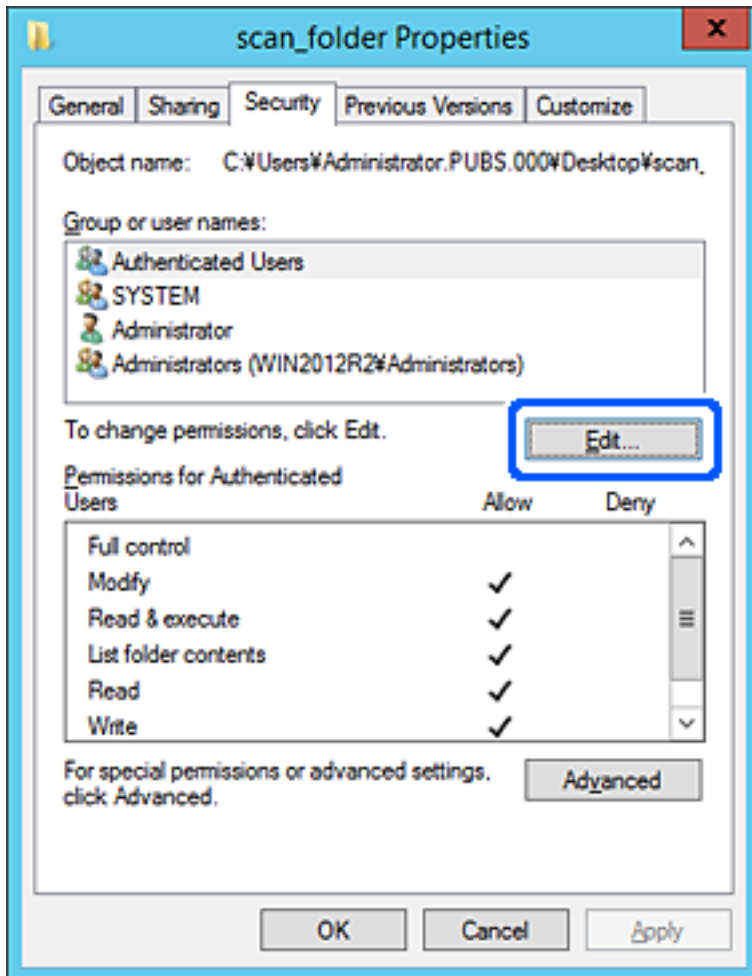

- Click **Add** under the **Group or user names**.

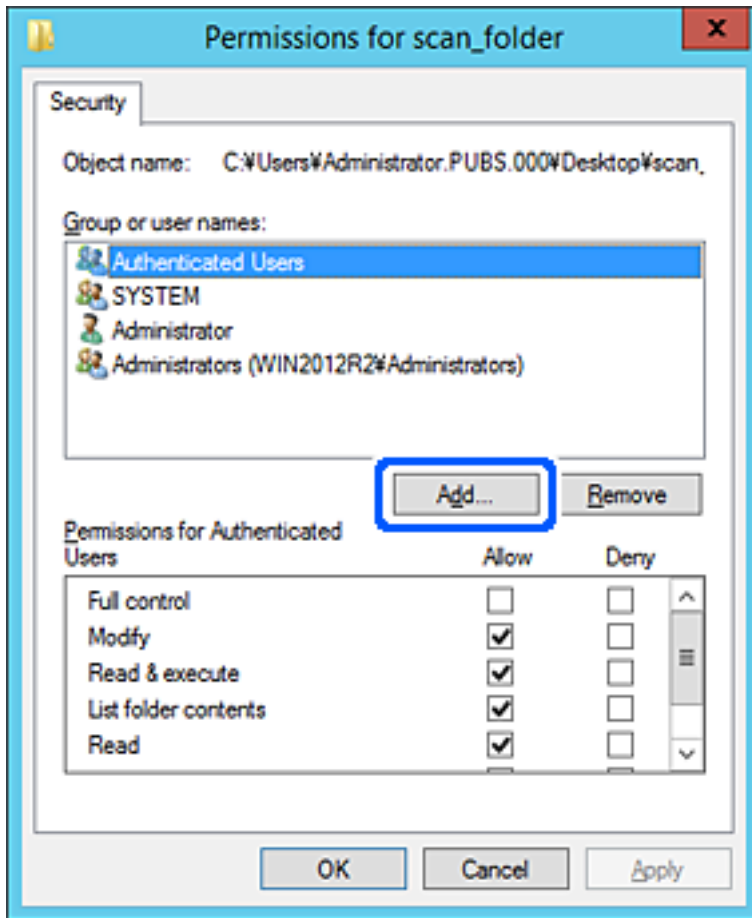

- Enter the group or user name that you want to permit access, and then click **Check Names**.

An underline is added to the name.

Note:

If you do not know the full name of the group or user, enter part of the name, and then click **Check Names**. The group names or user names that match part of the name are listed, and then you can select the full name from the list.

If just one name matches, the full name with underlining is displayed in **Enter the object name to select**.

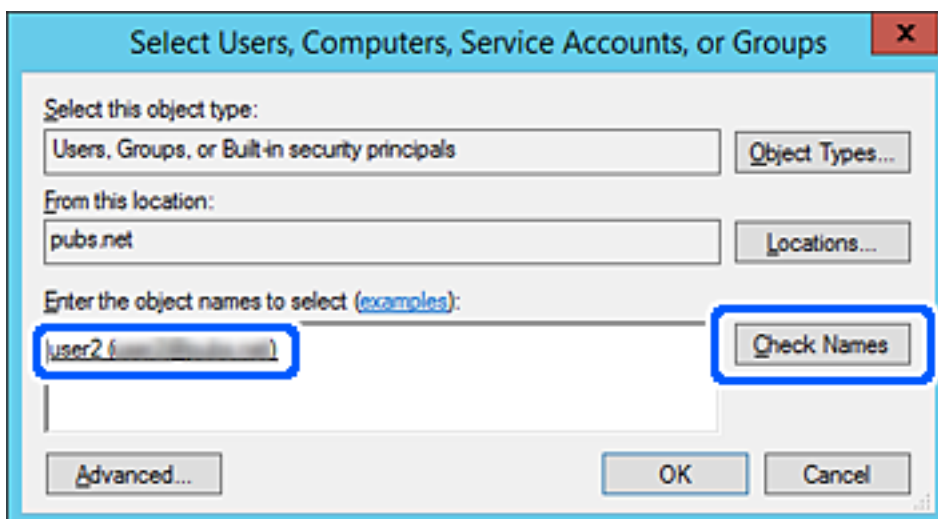

6. Click **OK**.
7. On the Permission screen, select the user name that is entered in **Group or user names** , select the access permission on **Modify**, and then click **OK**.

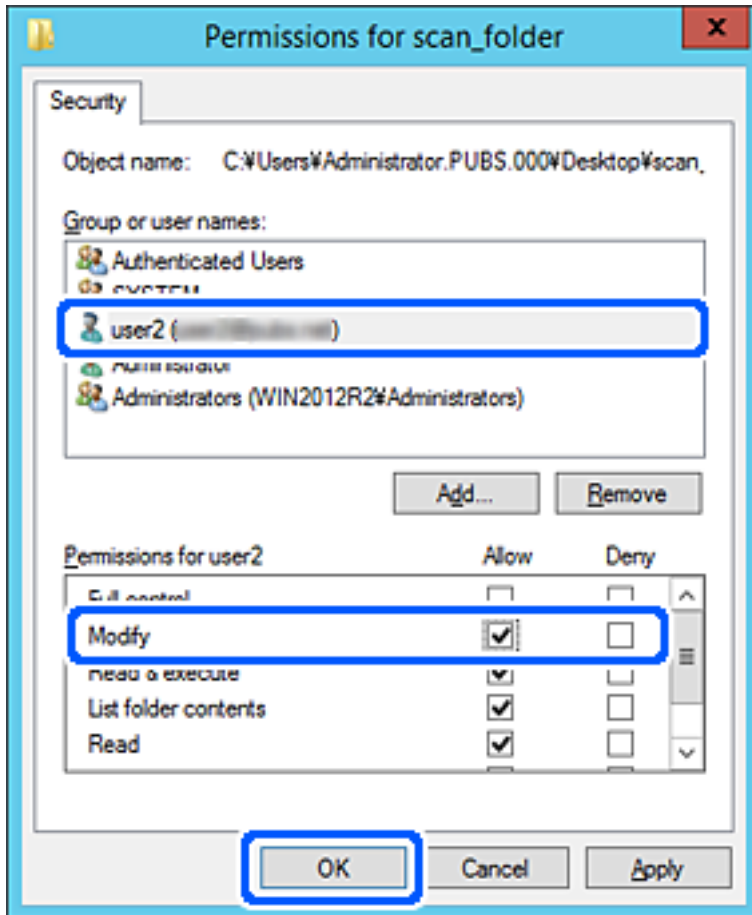

8. Click **OK** or **Close** to close the screen.

Check whether the file can be written or read on the shared folder from the computers of users or groups with access permission.

Making Contacts Available

Registering destinations in the scanner's contacts list allows you to easily enter the destination when scanning.

You can register the following types of destinations in the contacts list. You can register up to 300 entries in total.

Email	Destination for email. You need to configure the email server settings beforehand.
Network Folder	Destination for scan data. You need to prepare the network folder beforehand.

Contacts Configuration Comparison

There are two tools for configuring the scanner's contacts: Web Config and Epson Device Admin.

Features	Web Config	Epson Device Admin	Scanner's control panel
Registering a destination	✓	✓	–
Editing a destination	✓	✓	–
Adding a group	✓	✓	–
Editing a group	✓	✓	–
Deleting a destination or groups	✓	✓	–
Deleting all destinations	✓	✓	–
Importing a file	✓	✓	–
Exporting to a file	✓	✓	–

Registering a Destination to Contacts using Web Config

Note:

You can also register the contacts on the scanner's control panel.

1. Access Web Config and select the **Scan** tab > **Contacts**.
2. Select the number that you want to register, and then click **Edit**.
3. Enter **Name** and **Index Word**.
4. Select the destination type as the **Type** option.

Note:

You cannot change the **Type** option after registration is complete. If you want to change the type, delete the destination and then register again.

5. Enter a value for each item, and then click **Apply**.

Related Information

➔ [“Running Web Config on a Web Browser” on page 23](#)

Destination Setting Items

Items	Settings and Explanation
Common Settings	
Name	Enter a name displayed in the contacts in 30 characters or less in Unicode (UTF-8). If you do not specify this, leave it blank.

Items	Settings and Explanation
Index Word	Enter words to search in 30 characters or less in Unicode (UTF-8). If you do not specify this, leave it blank.
Type	Select the type of the address that you want to register.
Assign to Frequent Use	<p>Select to set the registered address as a frequently used address.</p> <p>When setting as a frequently used address, it is displayed on the top screen of scan, and you can specify the destination without displaying the contacts.</p>
Email	
Email Address	Enter between 1 and 255 characters using A-Z a-z 0-9 ! # \$ % & ' * + - . / = ? ^ _ { } ~ @.
Network Folder (SMB)	
Save to	<p>\\"Folder path"</p> <p>Enter the location where the target folder is located between 1 and 253 characters in Unicode (UTF-8), omitting "\\".</p>
User Name	Enter a user name to access a network folder in 30 characters or less in Unicode (UTF-8). However, avoid using control characters (0x00 to 0x1f, 0x7F).
Password	Enter a password to access a network folder in 20 characters or less in Unicode (UTF-8). However, avoid using control characters (0x00 to 0x1f, 0x7F).
FTP	
Secure Connection	Select FTP or FTPS according to the file transfer protocol the FTP server supports. Select FTPS to allow the scanner to communicate with security measures.
Save to	Enter the server name between 1 and 253 characters in ASCII (0x20-0x7E), omitting "ftp://" or "ftps://".
User Name	Enter a user name to access an FTP server in 30 characters or less in Unicode (UTF-8). However, avoid using control characters (0x00 to 0x1f, 0x7F). If the server allows anonymous connections, enter a user name such as Anonymous and FTP. If you do not specify this, leave it blank.
Password	Enter a password to access to an FTP server within 20 characters or less in Unicode (UTF-8). However, avoid using control characters (0x00 to 0x1f, 0x7F). If you do not specify this, leave it blank.
Connection Mode	Select the connection mode from the menu. If a firewall is set between the scanner and the FTP server, select Passive Mode .
Port Number	Enter the FTP server port number between 1 and 65535.
Certificate Validation	<p>The FTP server's certificate is validated when this is enabled. This is available when FTPS is selected for Secure Connection.</p> <p>To set up, you need to import the CA Certificate to the scanner.</p>
SharePoint(WebDAV)	
Secure Connection	Select HTTP or HTTPS according to the file transfer protocol the server supports. Select HTTPS to allow the scanner to communicate with security measures.
Save to	Enter the server name between 1 and 253 characters in ASCII (0x20-0x7E), omitting "http://" or "https://".

Items	Settings and Explanation
User Name	Enter a user name to access a server in 30 characters or less in Unicode (UTF-8). However, avoid using control characters (0x00 to 0x1f, 0x7F). If you do not specify this, leave it blank.
Password	Enter a password to access to a server within 20 characters or less in Unicode (UTF-8). However, avoid using control characters (0x00 to 0x1f, 0x7F). If you do not specify this, leave it blank.
Certificate Validation	The server's certificate is validated when this is enabled. This is available when HTTPS is selected for Secure Connection . To set up, you need to import the CA Certificate to the scanner.
Proxy Server	Select whether or not to use a proxy server.

Registering Destinations as a Group Using Web Config

If the destination type is set to **Email**, you can register the destinations as a group.

1. Access Web Config and select the **Scan** tab > **Contacts**.
2. Select the number that you want to register, and then click **Edit**.
3. Select a group from **Type**.
4. Click **Select** for **Contact(s) for Group**.
The available destinations are displayed.
5. Select the destination that you want to register to the group, and then click **Select**.
6. Enter a **Name** and **Index Word**.
7. Select whether or not you assign the registered group to the frequently used group.

Note:

Destinations can be registered to multiple groups.

8. Click **Apply**.

Related Information

➔ [“Running Web Config on a Web Browser” on page 23](#)

Backing Up and Importing Contacts

Using Web Config or other tools, you can back up and import contacts.

For Web Config, you can back up contacts by exporting the scanner settings that include contacts. The exported file cannot be edited because it is exported as a binary file.

When importing the scanner settings to the scanner, contacts are overwritten.

For Epson Device Admin, only contacts can be exported from the device's property screen. Also, if you do not export the security-related items, you can edit the exported contacts and import them because this can be saved as a SYLK file or CSV file.

Importing Contacts Using Web Config

If you have a scanner that allows you to backup contacts and is compatible with this scanner, you can register contacts easily by importing the backup file.

Note:

For instructions on how to back up the scanner contacts, see the manual provided with the scanner.

Follow the steps below to import the contacts to this scanner.

1. Access Web Config, select **Device Management** tab > **Export and Import Setting Value** > **Import**.
2. Select the backup file you created in **File**, enter the password, and then click **Next**.
3. Select the **Contacts** checkbox, and then click **Next**.

Backing up Contacts Using Web Config

Contacts data may be lost due to a scanner malfunction. We recommend that you make a backup of the data whenever you update the data. Epson shall not be responsible for the loss of any data, for backing up or recovering data and/or settings even during a warranty period.

Using Web Config, you can back up the contact data stored in the scanner to the computer.

1. Access Web Config, and then select the **Device Management** tab > **Export and Import Setting Value** > **Export**.
2. Select the **Contacts** checkbox under the **Scan** category.
3. Enter a password to encrypt the exported file.
You need the password to import the file. Leave this blank if you do not want to encrypt the file.
4. Click **Export**.

Export and Bulk Registration of Contacts Using Tool

If you use Epson Device Admin, you can back up just the contacts and edit the exported files, then register them all at once.

It is useful if you want to back up only the contacts or when you replace the scanner and you want to transfer the contacts from the old one to new one.

Exporting Contacts

Save the contacts information to the file.

You can edit files saved in SYLK format or csv format by using a spreadsheet application or text editor. You can register all at once after deleting or adding the information.

Information that includes security items such as password and personal information can be saved in binary format with a password. You cannot edit the file. This can be used as the backup file of the information including the security items.

1. Start Epson Device Admin.
2. Select **Devices** on the side bar task menu.
3. Select the device you want to configure from the device list.
4. Click **Device Configuration** on the **Home** tab on the ribbon menu.
When the administrator password has been set, enter the password and click **OK**.

5. Click **Common > Contacts**.

6. Select the export format from **Export > Export items**.

All Items

Export the encrypted binary file. Select when you want to include the security items such as password and personal information. You cannot edit the file. If you select it, you have to set the password. Click **Configuration** and set a password between 8 and 63 characters long in ASCII. This password is required when importing the binary file.

Items except Security Information

Export the SYLK format or csv format files. Select when you want to edit the information of the exported file.

7. Click **Export**.
8. Specify the place to save the file, select the file type, and then click **Save**.
The completion message is displayed.
9. Click **OK**.
Check that the file is saved to the specified place.

Importing Contacts

Import the contacts information from the file.

You can import the files saved in SYLK format or csv format or the backed-up binary file that includes the security items.

1. Start Epson Device Admin.
2. Select **Devices** on the side bar task menu.
3. Select the device you want to configure from the device list.

4. Click **Device Configuration** on the **Home** tab on the ribbon menu.
When the administrator password has been set, enter the password and click **OK**.
5. Click **Common > Contacts**.
6. Click **Browse** on **Import**.
7. Select the file you want to import and then click **Open**.
When you select the binary file, in **Password** enter the password you set when exporting the file.
8. Click **Import**.
The confirmation screen is displayed.
9. Click **OK**.
The validation result is displayed.
 - Edit the information read
Click when you want to edit the information individually.
 - Read more file
Click when you want to import multiple files.
10. Click **Import**, and then click **OK** on the import completion screen.
Return to the device's property screen.
11. Click **Transmit**.
12. Click **OK** on the confirmation message.
The settings are sent to the scanner.
13. On the sending completion screen, click **OK**.
The scanner's information is updated.
Open the contacts from Web Config or scanner's control panel, and then check that the contact is updated.

Using Document Capture Pro Server

By using Document Capture Pro Server, you can manage the sorting method, saving format, and forwarding destination of a scanning result executed from the scanner's control panel. You can call and execute a job previously registered on the server from the scanner's control panel.

Install it on the server computer.

For more information on Document Capture Pro Server, contact your local Epson office.

Setting Server Mode

To use Document Capture Pro Server, set up as follows.

1. Access Web Config and select the **Scan** tab > **Document Capture Pro**.
2. Select **Server Mode** for **Mode**.
3. Enter the address of the server with Document Capture Pro Server installed on it for **Server Address**.
Enter between 2 and 255 characters in either IPv4, IPv6, host name or FQDN format. For FQDN format, you can use alphanumeric characters in ASCII (0x20-0x7E) and "-" except for at the beginning and end of the address.
4. Click **OK**.
The network is re-connected, and then the settings are enabled.

Registering Preset or Quick Send Buttons

You can register up to 12 frequently used scanning setting as **Preset**.

Settings registered to the preset number 1 to 3 are assigned to the  (Quick Send) buttons on the scanner.

You can register the following destinations as Preset.

- Network folder
- Email address

Note:

Configure a network folder or email server before creating a preset.

1. Access Web Config.
["Running Web Config on a Web Browser" on page 23](#)
2. Login as an administrator to change the scanner settings.
Click **Administrator Login** at the top-right of the screen. Enter the **User Name** and **Current password**, and then click **OK**.
Note:
*If **Administrator Logout** is displayed at the top-right of the screen, you are already logged in as an administrator.*
3. Select **Scan** tab > **Presets**.
4. Select the **Presets** number you want to configure, and then click **Edit**.
5. Select **Type**, and then click **Next**.
6. Enter the name you want to display, and then click **Select from Contacts** or **Enter Destination** to set the destination information.
You can enter the email address manually to add to the destination.
7. If **Scan to Email** is selected as the **Type**, set the **Email Settings**.
8. If **Scan to Network Folder/FTP** is selected as the **Type**, set the **File Settings**.

9. Make the scan settings.
10. If PDF is selected as the **File Format**, set the **PDF Settings**.
11. Click **OK** to apply the settings.

Related Information

- ➔ [“Setting a Shared Network Folder” on page 65](#)
- ➔ [“Configuring a Mail Server” on page 62](#)
- ➔ [“Scanning Using Quick Send Buttons” on page 92](#)

Email Settings

Note:

The items may not be available depending on other settings you made.

Items	Settings and Explanation
Subject	Enter a subject for the email in alphanumeric characters and symbols.
Filename Prefix	Enter a prefix for the name of the images in alphanumeric characters and symbols.
Add Date	Add the date to the file name.
Add Time	Add the time to the file name.
Attached File Max Size	Select the maximum file size that can be attached to the email.

File Settings

Note:

The items may not be available depending on other settings you made.

Items	Settings and Explanation
Filename Prefix	Enter a prefix for the name of the images in alphanumeric characters and symbols.
Add Date	Add the date to the file name.
Add Time	Add the time to the file name.

Scan Settings

Note:

The items may not be available depending on other settings you made.

Items	Settings and Explanation
File Format	Select the format in which to save the scanned image. When you select PDF, PDF/A, or TIFF as the file format, select whether to save all originals as one file (multi-page) or save each original separately (single page).
Color Mode	Select the color you want to use to save the scanned image. <input type="checkbox"/> Color/Black & White : Converts the scanned image into 24-bit color or monochrome (black and white binary). <input type="checkbox"/> Color/Grayscale : Converts the scanned image into 24-bit color or 8-bit gray.
Resolution	Select the scanning resolution.
Scan Area	Select the scan area. If the size of the original you want to scan is not on the list, select User-Defined , and then create the size manually.
2-Sided Scanning	Scan both sides of the original.
Binding(Original)	Select the binding direction of the original.
Density	Select the contrast of the scanned image.
Compression Ratio	Select the compression rate.
Remove Shadow	Remove the shadows of the original that appear in the scanned image.
Frame	Remove the shadows at the edge of the original.
Remove Background	Select to remove the background from the originals. You can select the level of the effect.
Automatic Feeding Mode	Set Automatic Feeding Mode. This feature allows you to scan originals automatically when they are loaded in the ADF. This feature is useful when scanning different sizes or types of originals one by one. Adjust the edge guides of the scanner before placing each original.
Rotate	Select the rotation angle depending on the original you want to scan.
Text Enhancement	Make blurred letters in the original clear and sharp.
Edge Enhancement	You can enhance the text edges (the border between the text and the background). You can select the level of the effect. When you increase the value, the edges of thin text become black. Decrease the value if there is too much noise in the scanned image.
Threshold	Adjust the borderline for monochrome binary (black or white). The black areas become larger when you increase the value, and the white areas become larger when you decrease the value.
Noise reduction level	Adjust the level of noise reduction (unnecessary black dots). The higher the level, the more noise reduction is applied.
Correct Document Skew	Correct the slant of the original.
Cutting position adjustment	Adjust the cropping area margins for auto original size detection.
Scan laminated card	For laminated originals, transparent areas around the edges are also scanned.
Skip Blank Pages	Skip blank pages if there are any in the originals.

Items	Settings and Explanation
Blank paper removal level	Adjust the amount of blank page detection. If you set this to a high level, you can skip any originals with light colors or offset as blank pages.
Detect Double Feed	Display a warning when multiple originals are fed at the same time.
Ultrasonic sensor	Detect a double feed using an ultrasonic sensor.
Detection area (Min)	Set the minimum area to be detected by the ultrasonic sensor.
Detection area (Max)	Set the maximum area to be detected by the ultrasonic sensor.
Length	Detect a double feed by the length. When the length of the second original scanned is different from the first, this is identified as a double feed.
Difference in length	Specify the difference in the length to be detected.

PDF Settings

Note:

The items may not be available depending on other settings you made.

Items	Settings and Explanation
Document Open Password	Set a password for opening PDF files.
Permissions Password	Set a password to restrict access to editing or printing PDF files.
Printing	Restrict access to printing PDF files.
Editing	Restrict access to features such as editing extracting, or adding comments to PDF files.

Basic Scanning

Scanning Using the Scanner's Control Panel.	92
Scanning from a Computer.	96

Scanning Using the Scanner's Control Panel

You can use the following methods to save scanned images from the scanner's control panel.

Using  (Quick Send) button, or Preset

You can save the scanned image to a network folder, or send the image by e-mail using pre-configured settings.

You can configure the settings in Web Config.

Computer

You can save the scanned image to a computer connected to the scanner.

WSD

You can use the WSD feature to save the scanned image to a computer connected to the scanner, using WSD feature.

Related Information

- ➔ [“Scanning Using Quick Send Buttons” on page 92](#)
- ➔ [“Scanning Using Preset Settings” on page 93](#)
- ➔ [“Scanning Originals to a Computer” on page 93](#)
- ➔ [“Scanning Using WSD” on page 94](#)

Scanning Using Quick Send Buttons

Using  (Quick Send) buttons, you can save the scanned image to a network folder, or send the image by e-mail using pre-configured settings.

You can configure the settings in Web Config.

1. Place the originals.

2. Press any of the  (Quick Send) buttons.

The **Quick Send** screen is displayed, and configured destinations are listed.

Note:

You can also display the **Quick Send** screen by selecting **Quick Send** on the home screen.

3. Press the  (Quick Send) button for the destination to which you want to send your scans.

Scanning starts.

Related Information

- ➔ [“Registering Preset or Quick Send Buttons” on page 87](#)

Scanning Using Preset Settings

You can load the pre-configured **Preset** settings you want to use to scan.

1. Place the originals.
2. Select **Preset** on the home screen of the scanner's control panel.
3. On the scanner's control panel, select **Preset** using the ◀ or ▶ button, and then press the **OK** button.
4. On the **Preset** selecting screen, select the setting using the ◀ or ▶ button.
5. Press the ⬡ button.

Related Information

➔ [“Registering Preset or Quick Send Buttons” on page 87](#)

Scanning Originals to a Computer

You can scan originals from the control panel by using jobs created in Document Capture Pro (Windows)/ Document Capture (Mac OS).

Note:

- ❑ *Before scanning, install Document Capture Pro/Document Capture on your computer and create the job. There is a preset job that saves scanned images as PDFs.*
- ❑ *Document Capture Pro does not support Windows Server.*
- ❑ *Before scanning, make sure that the scanner is correctly connected to the computer.*

1. Place the originals.
2. On the scanner's control panel, select **Computer** using the ◀ or ▶ button, and then press the **OK** button.
3. If the **Select Computer** screen is displayed, select the computer from the screen.
4. On the **Select Job** screen, select the job using the ◀ or ▶ button.

Note:

- ❑ *You can start scanning immediately on the **Select Job** screen by pressing the ⬡ button.*

- ❑ *Press the ▼ button to make **Scanner Settings**.*

·**Slow:** Slows down the scanning speed. Enable this to scan originals that are likely to jam, for example thin paper.

·**Slow:** Slows down the scanning speed. Enable this to scan originals that are likely to jam, for example thin paper.

·**DFDS Function:** Skips double feed detection once and continues scanning. Enable this to scan originals that are detected as double feeds, for example plastic cards or envelopes.

·**Double Feed Stop Timing:** Set the operation when any double feed is detect.

·**Paper Protection:** Reduces damage to the originals by stopping scanning immediately when a feeding error occurs.

·**Detect Glass Dirt:** Detects dirt on the glass surface inside the scanner.

After making **Scanner Settings**, press ↶ to return to the **Select Job** screen.

5. Press the **OK** button to view the job settings.

6. Check the job settings.

You can scroll the screen using the ▲ or ▼ button.

If you want to edit the scan settings, press the **OK** button. Select the item using the ▲ or ▼ button, and then edit the setting using ◀ or ▶ button. When you have finished editing the job, press the **OK** button.

Note:

*If you set **Disable job setting changes on control panel** in Document Capture Pro/Document Capture, you cannot change the settings.*

7. Press the ⬡ button to start scanning.

Related Information

➔ [“Setting a Job” on page 115](#)

➔ [“Enabling a Job to Run from the Control Panel \(Button Assignment\)” on page 122](#)

Scanning Using WSD

Note:

This feature is only available for computers running Windows 10/Windows 8.1/Windows 8.

If you are using Windows 7, you need to setup your computer in advance using this feature.

1. Place the originals.

2. On the scanner's control panel, select **WSD** using the ◀ or ▶ button, and then press the **OK** button.

3. Select the computer to which you want to save the scanned images.

4. Press the ⬡ button.

Setting Up a WSD Port

This section explains how to set up a WSD port for Windows 7.

Note:

For Windows 10/Windows 8.1/Windows 8, the WSD port is set up automatically.

The following conditions must be met to set up a WSD port.

The scanner and the computer are connected to the network.

The scanner driver is installed on the computer.

1. Turn the scanner on.

2. Click the start button on the computer, and then click **Network**.

3. Right-click the scanner, and then click **Install**.
Click **Continue** when the **User Account Control** screen is displayed.
Click **Uninstall** and start again if the **Uninstall** screen is displayed.

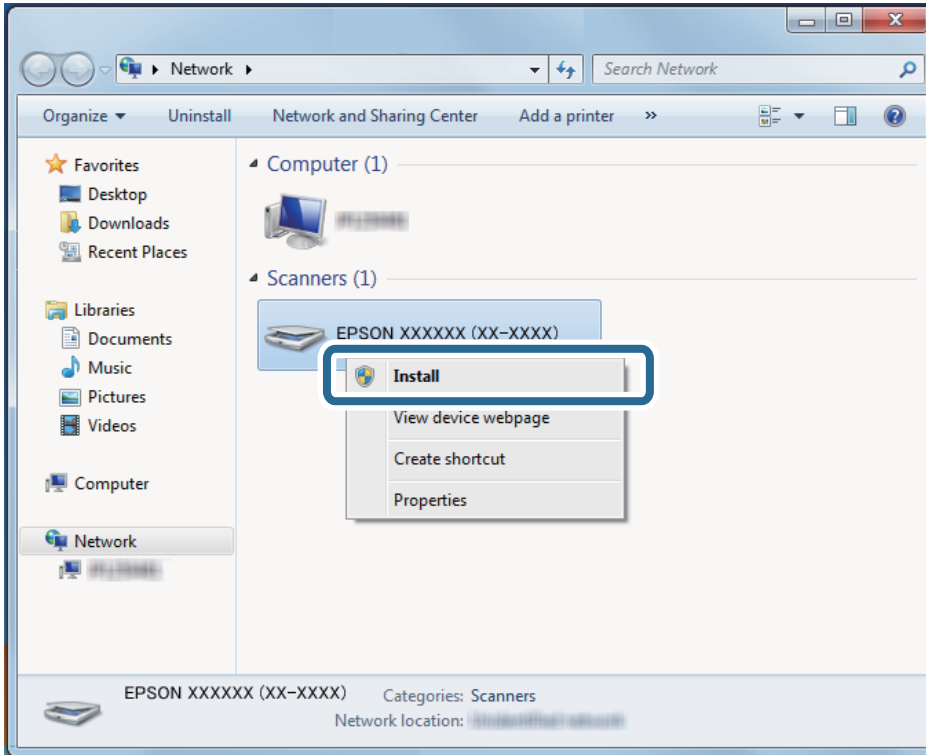

Note:
The scanner name you set on the network and model name (EPSON XXXXXX (XX-XXXX)) are displayed on the network screen. You can check a scanner's name that was set on the network from the scanner's control panel.

4. Click the message displayed on the computer, which says that your device is ready to use.

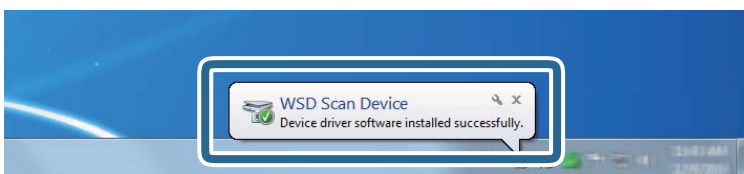

5. Check the message on the screen, and then click **Close**.

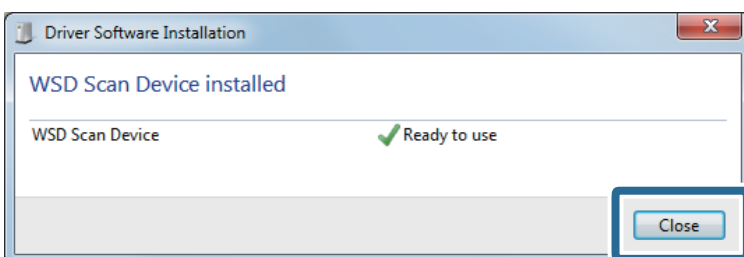

6. Open the **Devices and Printers** screen.
Click start > **Control Panel** > **Hardware and Sound** (or **Hardware**) > **Devices and Printers**.
7. Check that an icon with the scanner's name is displayed on the network.
Select the scanner name when using with WSD.

Scanning from a Computer

Scanning Using Document Capture Pro (Windows)

This application allows you to perform various tasks such as saving the image to your computer, sending it by email, printing, and uploading to a server or a cloud service. You can also use a variety of methods to sort the documents into separate files, such as detecting barcodes or characters on the pages. You can also register scanning settings for a job to simplify scanning operations.

Note:

- For detailed information on how to use Document Capture Pro, refer to the following URL:

<https://support.epson.net/dcp/>

- Document Capture Pro does not support Windows Server.

1. Start Document Capture Pro.
 - Windows 10
Click the start button, and then select **Epson Software** > **Document Capture Pro**.
 - Windows 8.1/Windows 8
Enter the application name in the search charm, and then select the displayed icon.
 - Windows 7
Click the start button, and then select **All Programs** > **Epson Software** > **Document Capture Pro**.

2. Click **Job Settings** on the **Job Scan** tab.

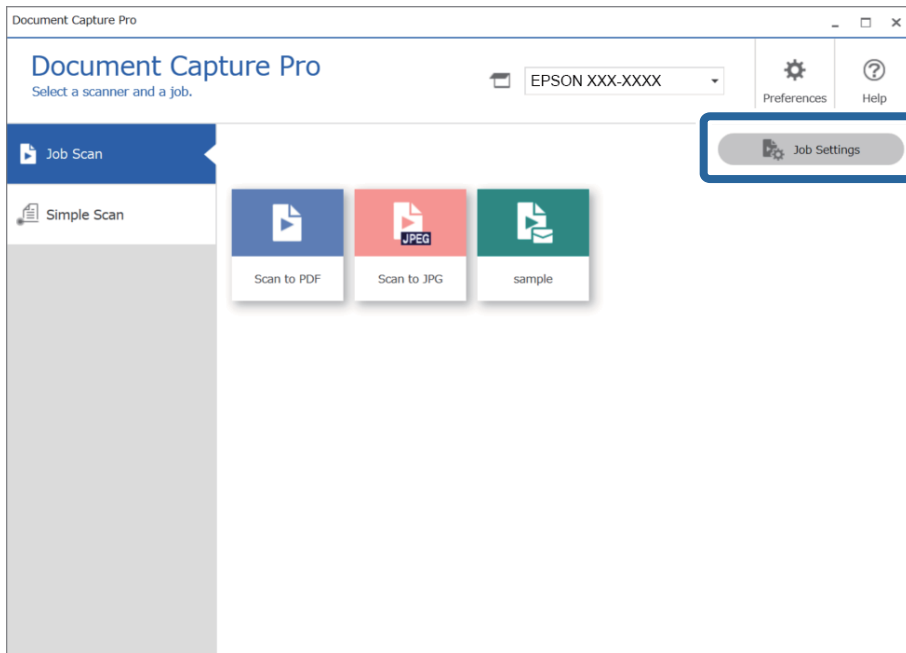

3. Click **New Job**.

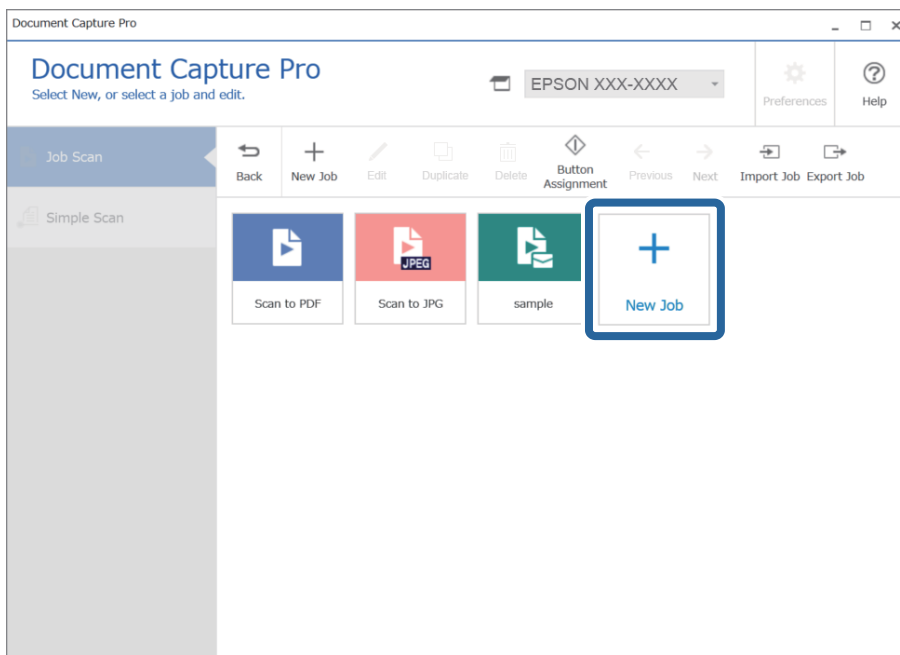

The **Job Settings** window is displayed.

4. Enter a Job Name.

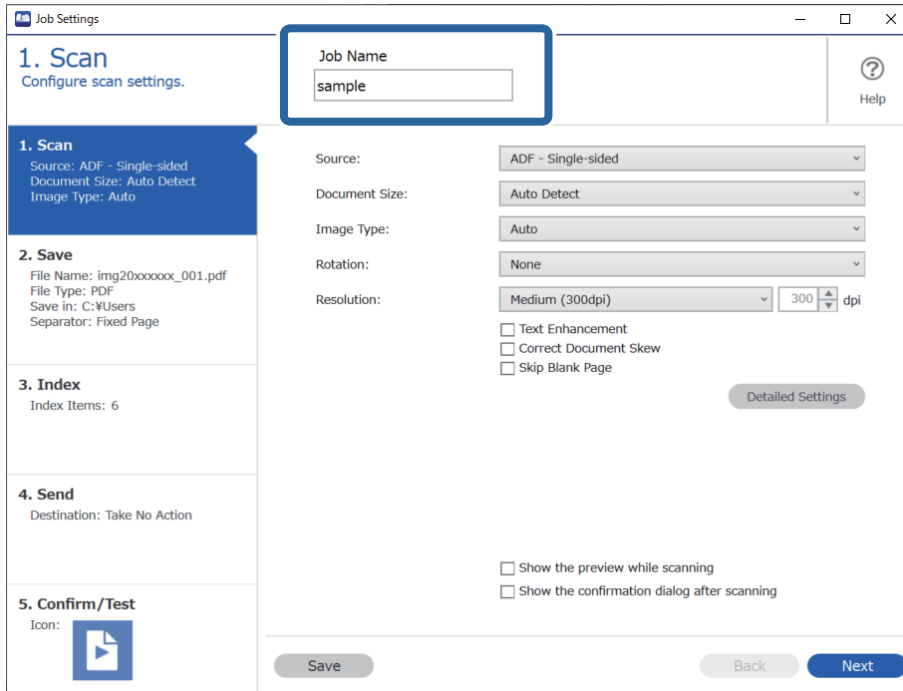

5. On the 1. Scan tab, set the scan job operations you want to create.

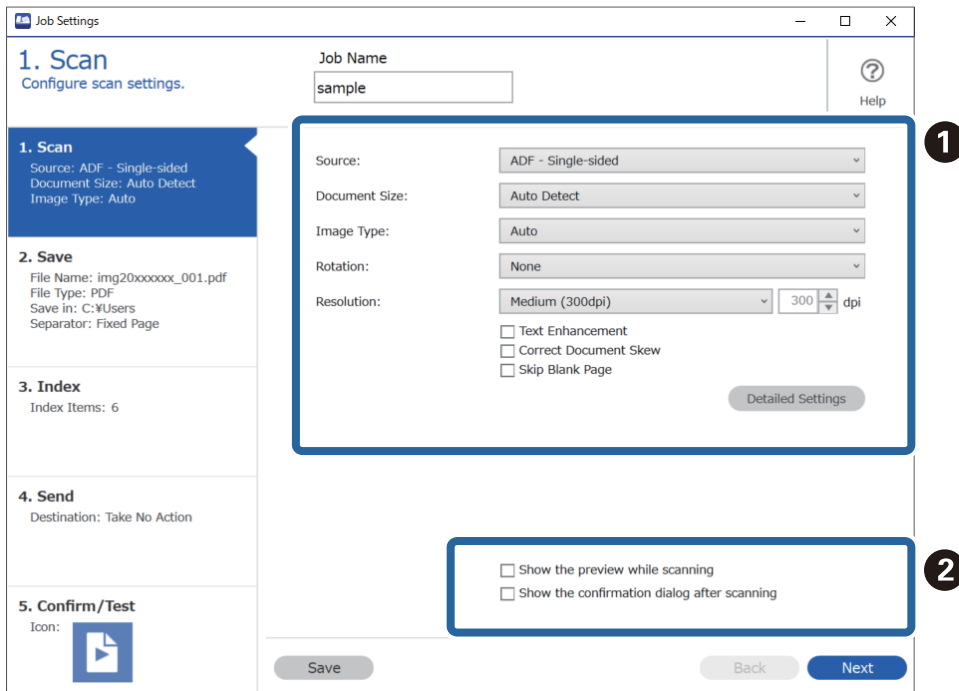

- ❑ ① Make basic scanning settings.
 - ❑ **Source:** Select the source where the original is placed. Select double-sided to scan both sides of the originals.
 - ❑ **Document Size:** Select the size of the original you placed.
 - ❑ **Image Type:** Select the color you want to use to save the scanned image.
 - ❑ **Rotation:** Select the rotation angle depending on the original you want to scan.
 - ❑ **Resolution:** Select the resolution.
 - ❑ **Text Enhancement:** Select to make blurred letters in the original clear and sharp.
 - ❑ **Correct Document Skew:** Select to correct the slant of the original.
 - ❑ **Skip Blank Page:** Select to skip blank pages if there are any in the originals.
 - ❑ **Detailed Settings** button: Select to use Epson Scan 2 features to adjust scanned images such as **Remove Background** or **Auto Area Segmentation**. Change the scan operation and click **Save** to return to the Document Capture Pro screen.

[“Scanning Using Epson Scan 2” on page 109](#)

- ❑ ② Change the settings as necessary.

Select **Show the preview while scanning** to display images while scanning.

Select **Show the confirmation dialog after scanning** to display a confirmation message asking if you want to continue scanning after completing a scan.

When you have finished making scanning settings, click **Next** or the **2. Save** tab.

- 6. On the **2. Save** tab, you can make settings for saving the scan results.

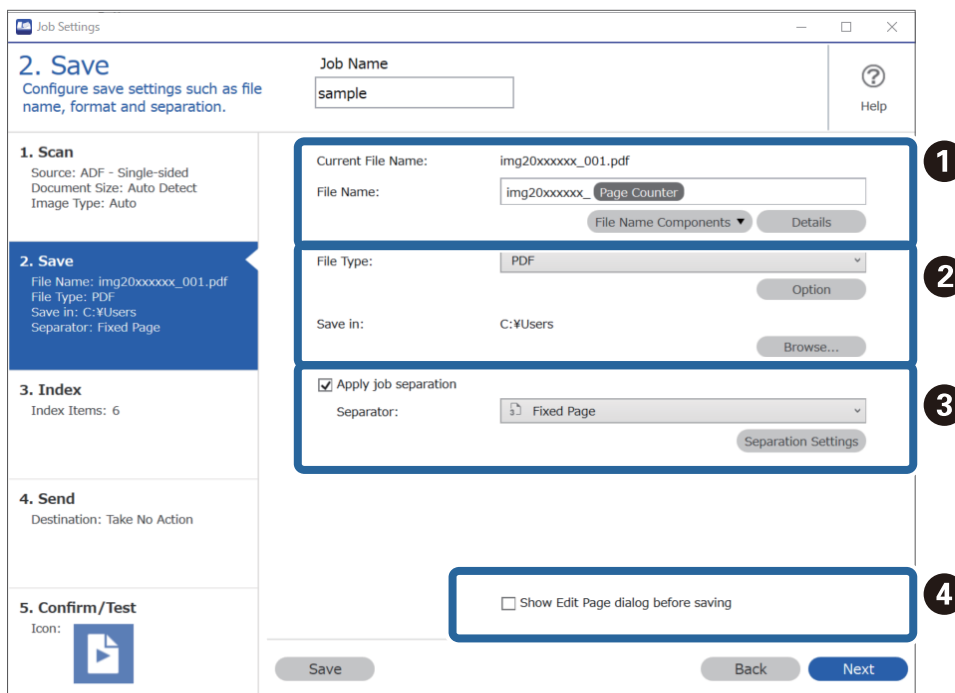

- ❑ ① Set the name of the file.
- ❑ ② Set the file save format and location.

- ❑ ③ When you want to separate jobs, select this to choose the separation method, and then select **Separation Settings** to make detailed settings.
- ❑ ④ Change the settings as necessary.

When you select **Show Edit Page dialog before saving**, you can make edits on the **Edit Scanned Results** screen after scanning.

When you have finished making save settings, click **Next** or the **3. Index** tab.

- 7. You can make index file settings on the **3. Index** tab.

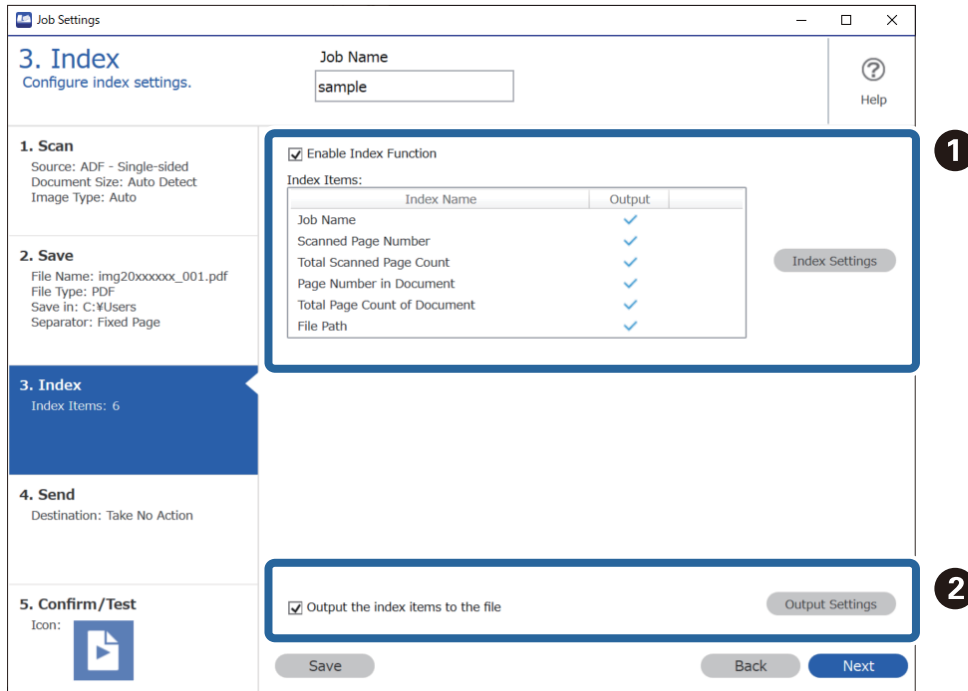

- ❑ ① When creating an index file, select **Enable Index Function**.
Click **Index Settings** and select the items you want to use for the index.
- ❑ ② Select **Output the index items to the file**, and then click **Output Settings** to set the output items and file name used when outputting to a file.

When you have finished making index settings, click **Next** or the **4. Send** tab.

- Set the destination settings on the **4. Send** tab.

When **Destination** is selected, setting items are displayed according to the send destination.

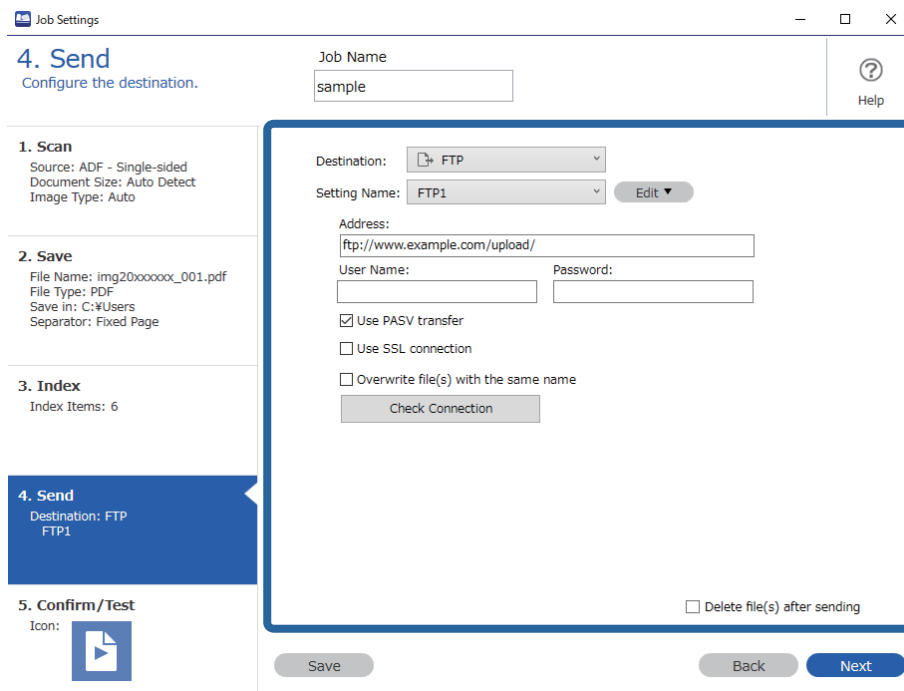

When you have finished making transfer settings, click **Next** or the **5. Confirm/Test** tab.

- Check the settings on the **5. Confirm/Test** tab, and then perform a test scan.

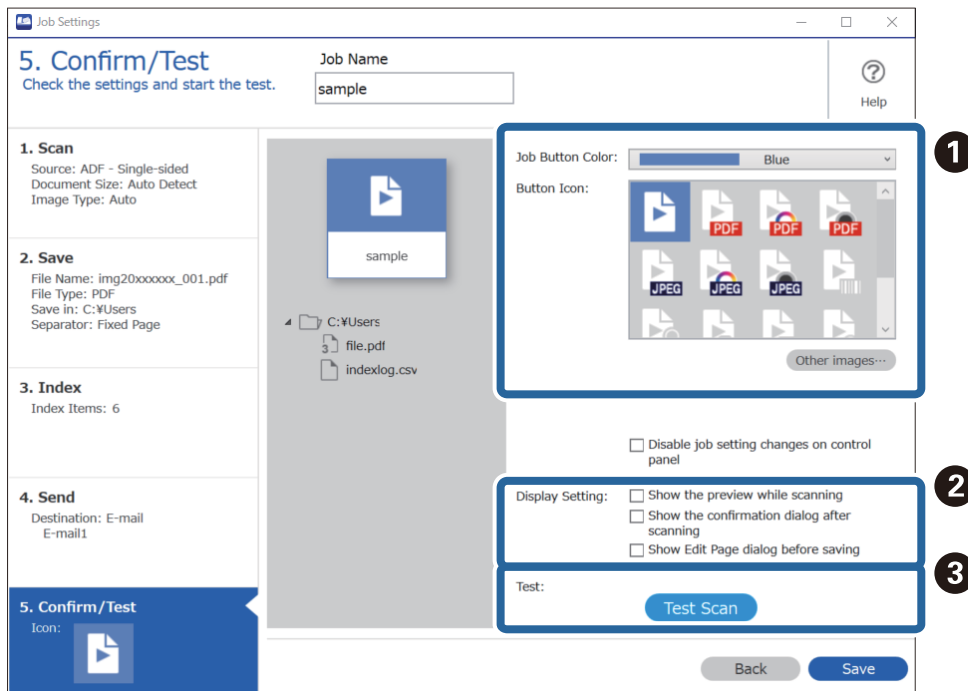

- 1 Change the job button color or icon.
- 2 Change the display settings used during and after scanning.

- ❑ 3 Perform a test scan using the job that is currently set.

- 10. Click **Save** to finish creating the job.

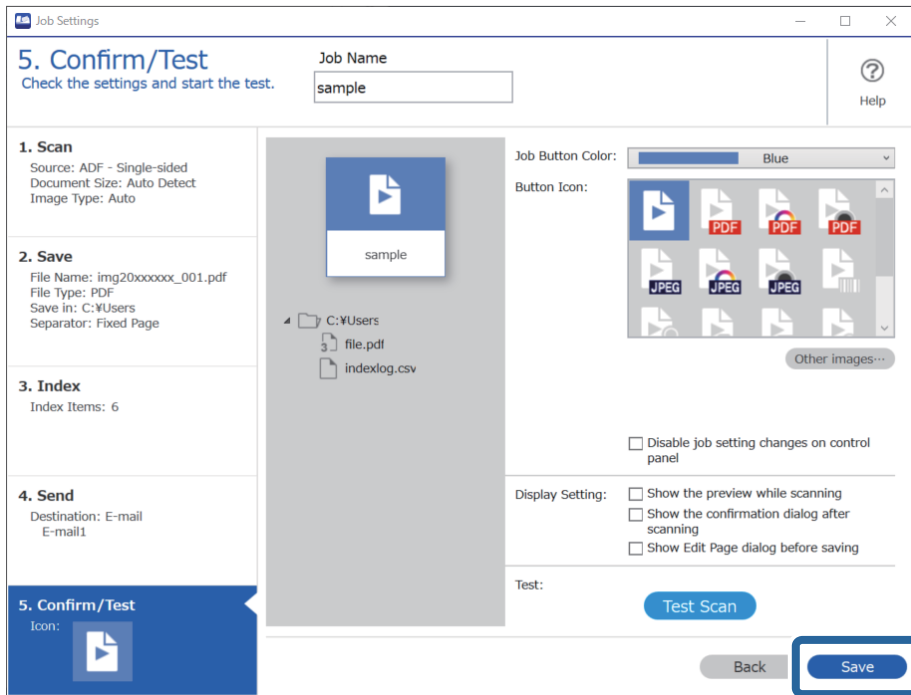

To finish making job settings, click the **Back** button on the left of the toolbar to return the job screen.

- 11. On the **Job Scan** tab, click the icon of the job you want to perform.

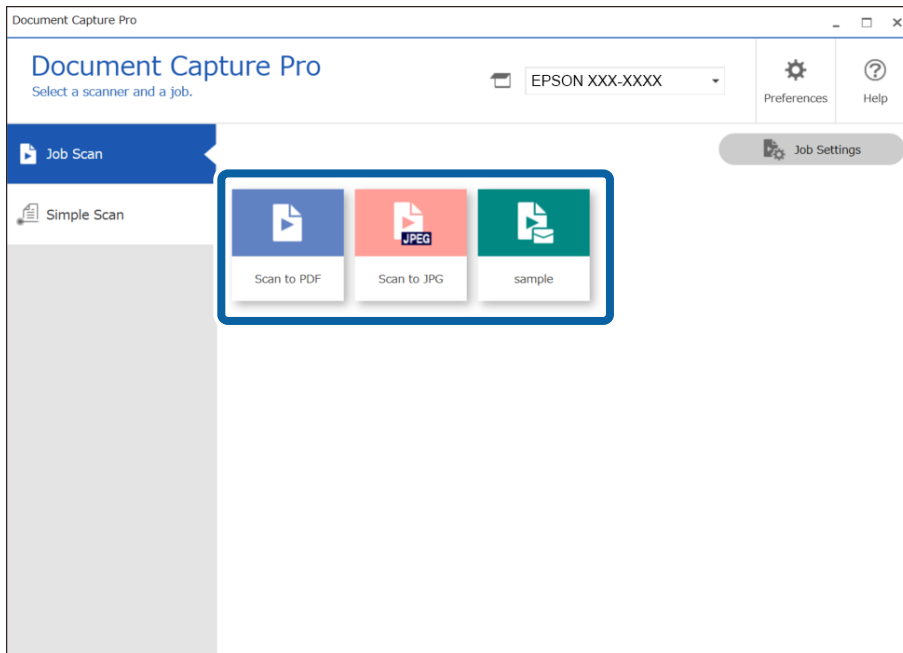

The selected job is performed.

- For jobs for which **Show Edit Page dialog before saving** has been selected in the Scan Settings, check the scan results on the **Edit Scanned Results** screen after scanning, and then make edits as necessary.

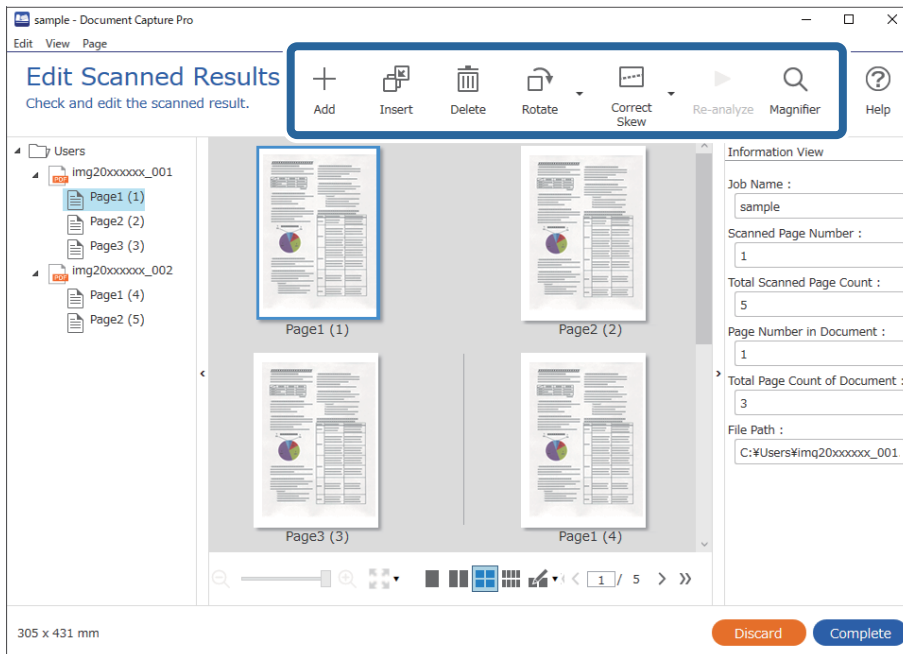

- Click **Complete** to finish performing the Job Scan.

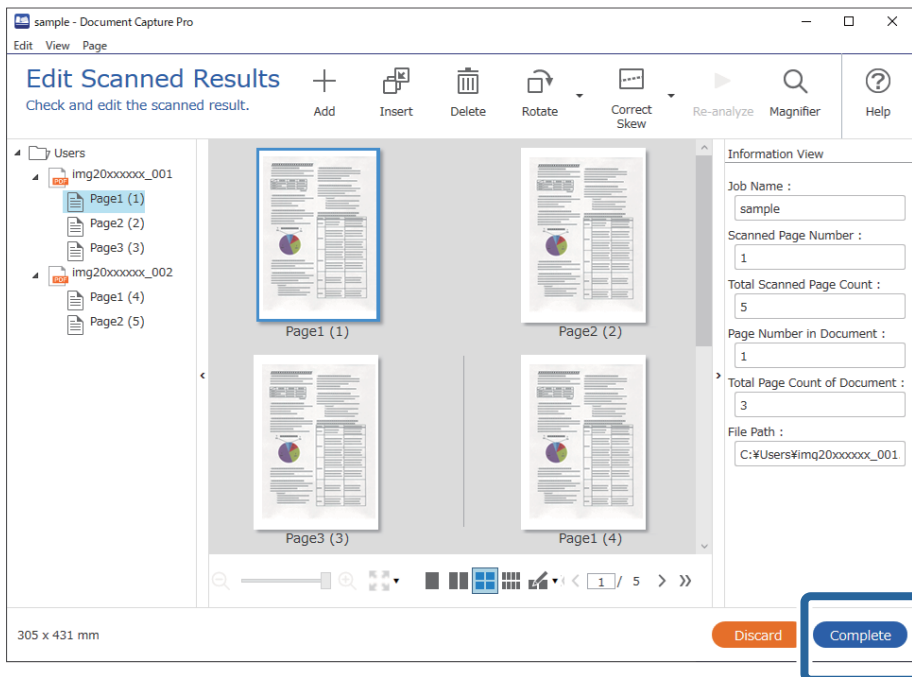

Scanning Using Document Capture (Mac OS)

This application allows you to perform various tasks such as saving the image to your computer, sending it by email, printing, and uploading to a server or a cloud service. You can also register scanning settings for a job to simplify scanning operations.

See the Document Capture help for details on the features.

Note:

Do not use the Fast User Switching function while using your scanner.

1. Start Document Capture.

Select **Finder > Go > Applications > Epson Software > Document Capture**.

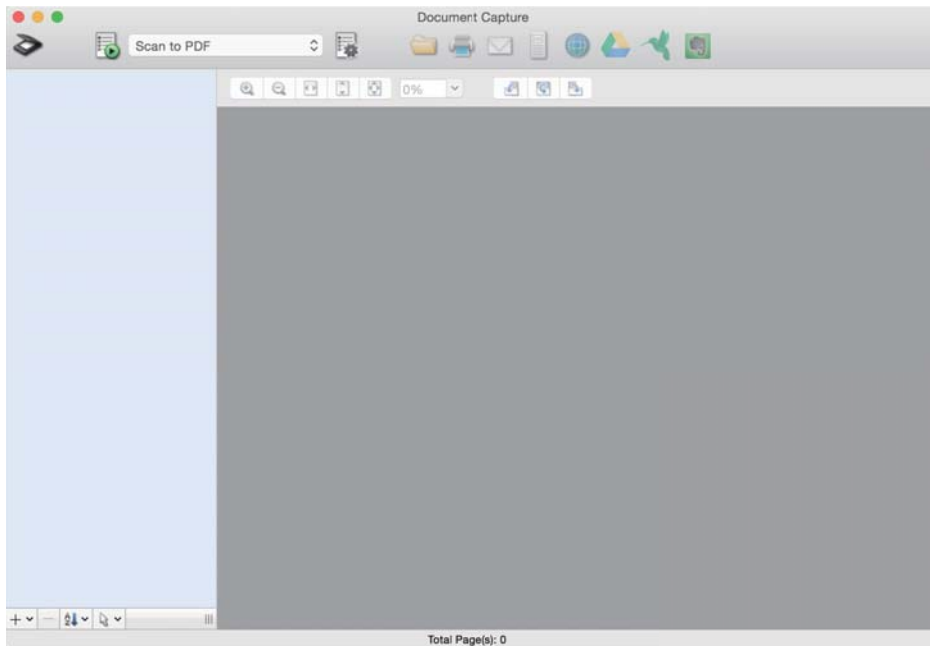

Note:

You may need to select the scanner you want to use from the scanners list.

2. Click .

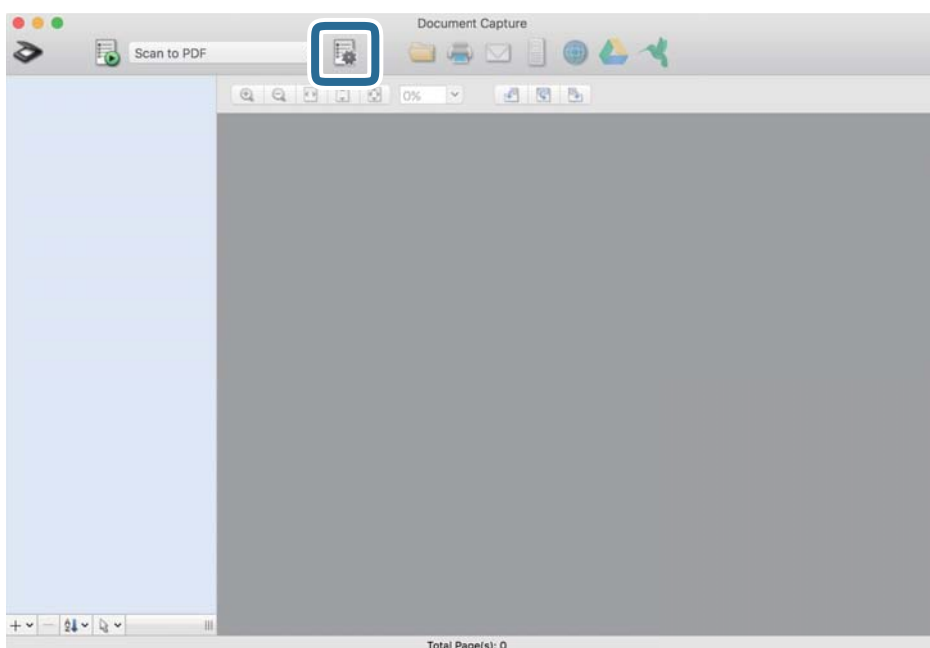

The **Job List** screen is displayed.

Note:

A preset job is available that allows you to save scanned images as a PDF. When using this job, skip this procedure and go to procedure 10.

3. Click the + icon.

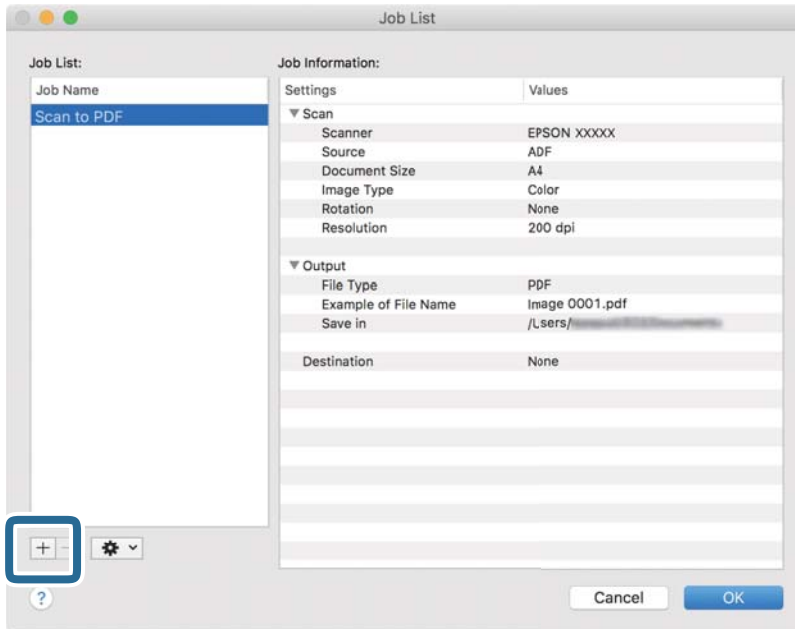

The job setting screen is displayed.

4. Set the **Job Name**.

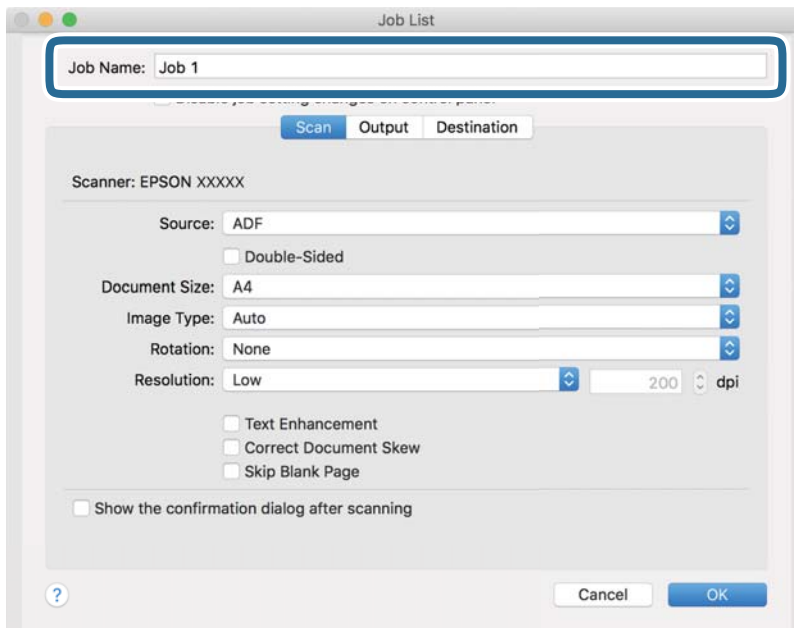

5. Make scanning settings on the **Scan** tab.

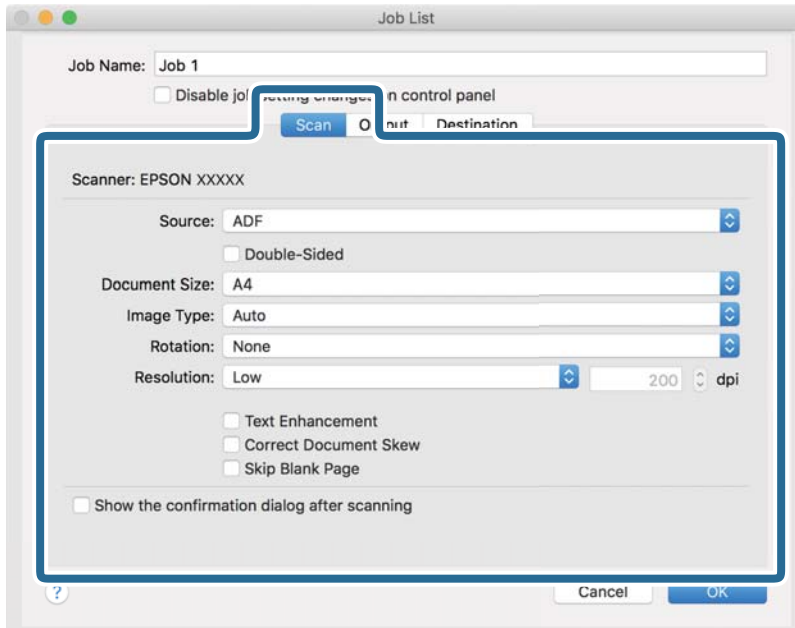

- Source:** Select the source where the original is placed. Select double-sided to scan both sides of the originals.
- Document Size:** Select the size of the original you placed.
- Image Type:** Select the color you want to use to save the scanned image.
- Rotation:** Select the rotation angle depending on the original you want to scan.
- Resolution:** Select the resolution.

Note:

You can also adjust the image using following items.

- Text Enhancement:** Select to make blurred letters in the original clear and sharp.
- Correct Document Skew:** Select to correct the slant of the original.
- Skip Blank Page:** Select to skip blank pages if there are any in the originals.

6. Click **Output**, and then make the output settings.

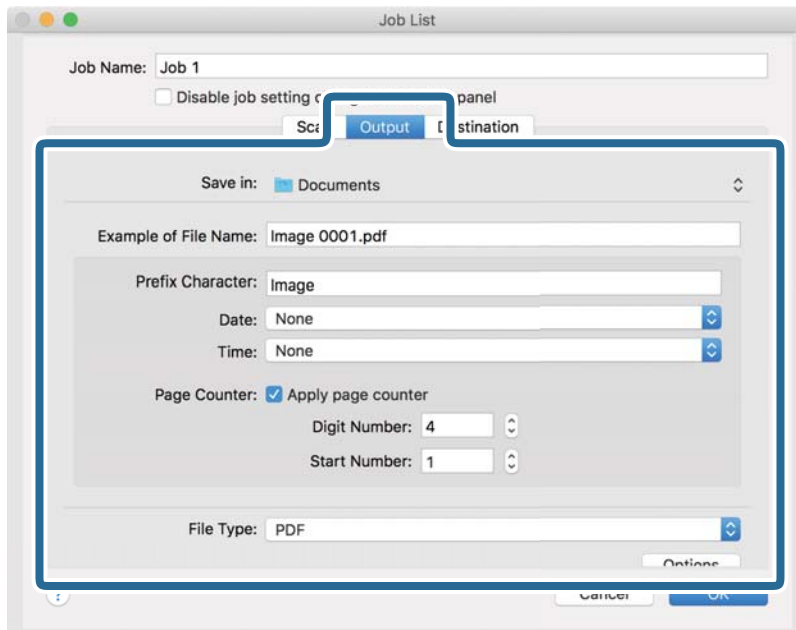

- Save in:** Select the save folder for the scanned image.
- Example of File Name:** Display an example of the file name for the current settings.
- Prefix Character:** Set a prefix for the file name.
- Date:** Add the date to the file name.
- Time:** Add the time to the file name.
- Page Counter:** Add the page counter to the file name.
- File Type:** Select the save format from the list. Click **Options** to make detailed settings for the file.

7. Click **Destination**, and then select the **Destination**.

Destination setting items are displayed according to the destination you selected. Make detailed settings as necessary. Click the ? (Help) icon for details on each item.

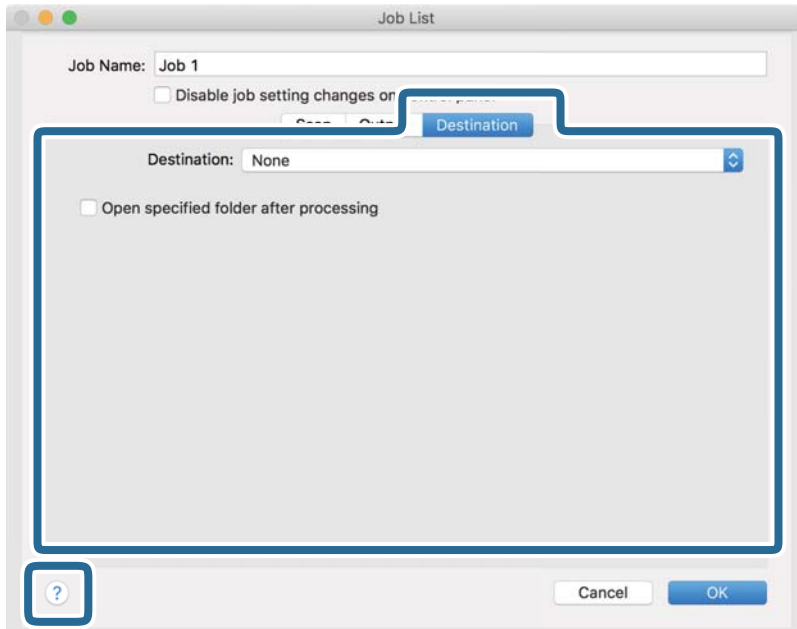

Note:

- If you want to upload to a cloud service, you need to set up your account with the cloud service in advance.
- If you want to use Evernote as the destination, download the Evernote application from the Evernote Corporation Website and install it before using this feature.

8. Click **OK** to close the job settings screen.
9. Click **OK** to close the **Job List** screen.
10. Place the original.

11. Select the job from the pull down list, and then click the  icon.

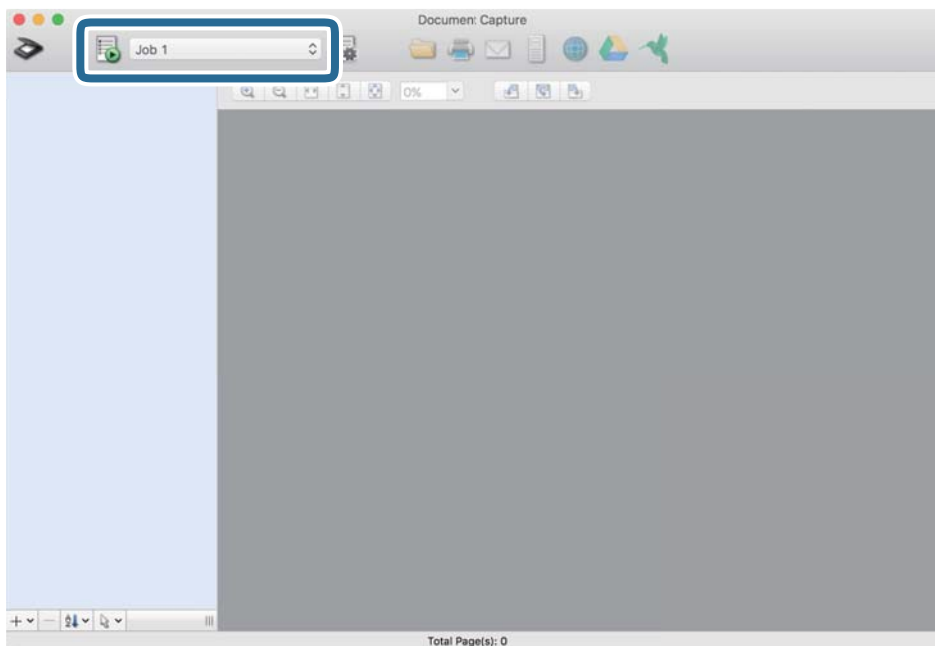

The selected job is performed.

12. Follow the on-screen instructions.

The scanned image is saved using the settings you made for the job.

Note:

You can scan the originals and send the scanned image without using the job. Click  and make scanning settings, and then click **Preview Scan**. Next, click the destination to which you want to send the scanned image.

Scanning Using Epson Scan 2

You can scan the originals using detailed settings that are suitable for text documents.

1. Place the original.
2. Start Epson Scan 2.
 - Windows 10
Click the start button, and then select **EPSON > Epson Scan 2**.
 - Windows 8.1/Windows 8
Enter the application name in the search charm, and then select the displayed icon.
 - Windows 7/Windows Vista
Click the start button, and then select **All Programs or Programs > EPSON > Epson Scan 2 > Epson Scan 2**.
 - Mac OS
Select **Go > Applications > Epson Software > Epson Scan 2**.

3. Make the following settings on the **Main Settings** tab.

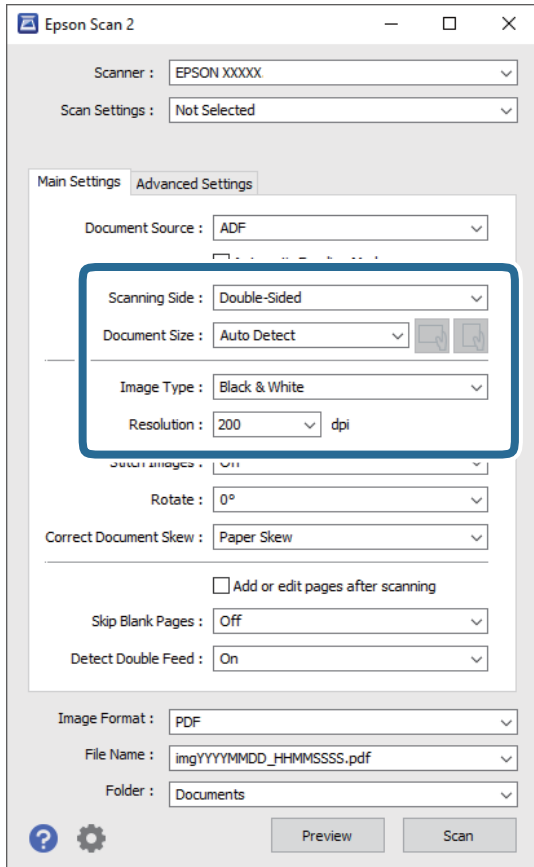

- Scanning Side:** Select the side of the original you want to scan. Select **Double-Sided** to scan both sides of the originals.
- Document Size:** Select the size of the original you placed.
-  (Original orientation) buttons: Select the set orientation of the original you placed. Depending on the size of the original, this item may be set automatically and cannot be changed.
- Image Type:** Select the color for saving the scanned image.
- Resolution:** Select the resolution.

Note:

- ADF** is set as the **Document Source** automatically.
- On the **Main Settings** tab, you can also make the following settings.
 - Stitch Images:** Select to stitch the images on the front and rear when scanning both sides of the original.
 - Rotate:** Select to rotate the original clockwise and scan it.
 - Correct Document Skew:** Select to correct the slant of the original.
 - Add or edit pages after scanning:** Select to add different originals or edit (rotate, move, and delete) the scanned pages after scanning.
 - Skip Blank Pages:** Select to skip blank pages if there are any in the originals.
 - Detect Double Feed:** Select to display a warning when multiple originals are fed at the same time.

4. Make other scan settings if necessary.

- You can preview the scanned image of the first side of the first page of the originals. Load only the first page of your originals into the input tray and click the **Preview** button. The preview window opens, the previewed image is displayed, and the page is ejected from the scanner.

Replace the ejected page together with the rest of the originals.

- On the **Advanced Settings** tab, you can make image adjustments using detailed settings which are suitable for text documents, such as the following.
 - Remove Background:** Select to remove the background from the originals.
 - Text Enhancement:** Select to make blurred letters in the original clear and sharp.
 - Auto Area Segmentation:** Select to make letters clear and images smooth when performing black and white scanning for a document that contains images.
 - Dropout:** Select to remove the color specified from the scanned image, and then save it in grayscale or black and white. For example, you can erase marks or notes you wrote in the margins with color pen when scanning.
 - Color Enhance:** Select to enhance the color specified for the scanned image, and then save it in grayscale or black and white. For example, you can enhance letters or lines that are in light colors.

Note:

Some items may not be available depending on other settings you made.

5. Set the file saving settings.

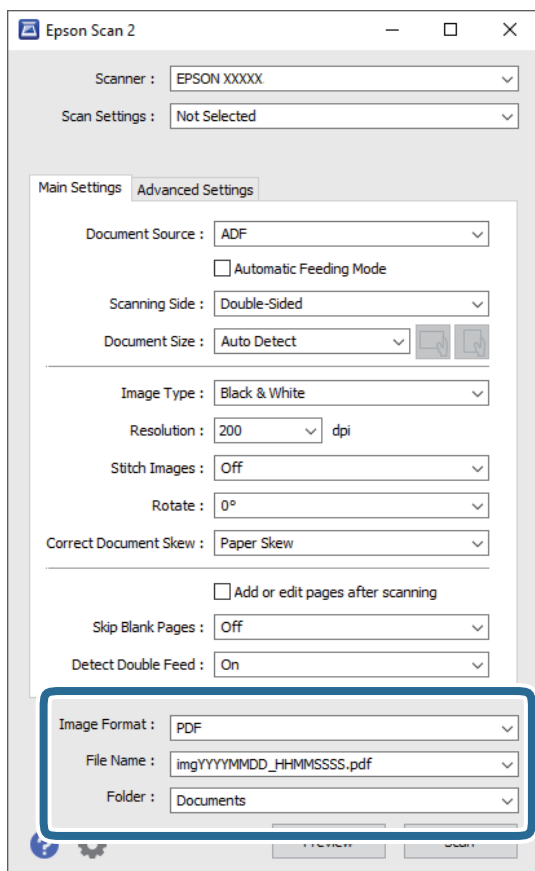

- Image Format:** Select the save format from the list.

You can make detailed settings for each save format except BITMAP and PNG. After selecting the save format, select **Options** from the list.

- File Name:** Check the save file name displayed.

You can change settings for file name by selecting **Settings** from the list.

- Folder:** Select the save folder for the scanned image from the list.

You can select other folder or create a new folder by selecting **Select** from the list.

6. Click **Scan**.

Note:

- You can also start scanning by pressing  button on the scanner.

- To scan originals that are likely to jam, for example thin paper, enable **Slow** on the control panel to slow down the scanning speed.

Press the  button, and then select **Scanner Settings > Slow**.

The scanned image is saved to the folder you specified.

Required Settings for Special Originals in Epson Scan 2 Window

You need to set certain items on the **Main Settings** tab in Epson Scan 2 window when scanning special originals.

When you are using Document Capture Pro, you can open the window by pressing the **Detailed Settings** button on the **Scan Settings** screen.

Type of Original	Required Settings
Envelopes	Select Off in Detect Double Feed .
Plastic cards	Select Plastic Card on the Document Size list, or select Off in Detect Double Feed .
Carrier Sheet	<ul style="list-style-type: none"> <input type="checkbox"/> If you select Auto Detect from the Document Size list, paper skew in the original is automatically corrected even if you select Off in Correct Document Skew. <input type="checkbox"/> If you select a other size than Auto Detect from the Document Size list, you can only use Contents Skew when using Correct Document Skew. <p>Paper Skew is not applied when this is selected. When you select Paper and Contents Skew, only contents skew is corrected.</p>
Large size originals	If the size of the original you want to scan is not on the Document Size list, select Customize to open the Document Size Settings window. Next, create the size manually on the window.
Long paper	If the size is not listed on the Document Size list, select Auto Detect (Long Paper) or select Customize to create a custom document size.
Laminated cards	<p>To scan transparent areas around the edges, select Customize on the Document Size list to open the Document Size Settings window. Next, select Scan laminated card in the window.</p> <p>Note: The appropriate effect may not be achieved depending on the original. If transparent areas around the edges are not scanned, select Customize from the Document Size list, and then create the size manually.</p>

Setting a Resolution That Suits the Scanning Purpose

Advantages and Disadvantages of Increasing the Resolution

Resolution indicates the number of pixels (smallest area of an image) for each inch (25.4 mm), and is measured in dpi (dots per inch). The advantage of increasing the resolution is that the details in the image become fine. The disadvantage is that the file size becomes large.

- File size becomes large
(When you double the resolution, the file size becomes about four times larger.)
- Scanning, saving, and reading the image takes a long time
- Sending and receiving emails or faxes takes a long time
- The image becomes too large to fit the display or print on the paper

List of Recommended Resolutions to Suit Your Purpose

See the table and set the appropriate resolution for the purpose of your scanned image.

Purpose	Resolution (Reference)
Displaying on a screen Sending by email	Up to 200 dpi
Using Optical Character Recognition (OCR) Creating a text searchable PDF	200 to 300 dpi
Printing using a printer Sending by fax	200 to 300 dpi

Advanced Scanning

Setting a Job.	115
Scanning Different Sizes or Types of Originals One by One (Automatic Feeding Mode).	124
Various Scanning Settings for Document Capture Pro (for Windows Only).	126

Setting a Job

You can register a set of operations, such as Scan-Save-Send, as a "job".

By registering a series of operations in advance as a job using Document Capture Pro (Windows), Document Capture (Mac OS) or Document Capture Pro Server (Windows Server), you can perform all of the operations by simply selecting the job.

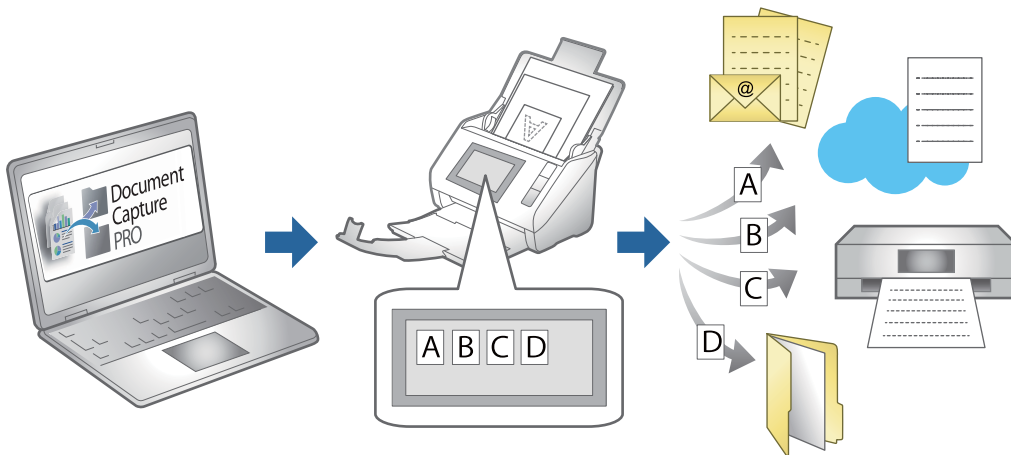

Creating and Registering a Job (Windows)

Explains how to set a job in Document Capture Pro. See the Document Capture Pro help for details on the features.

<https://support.epson.net/dcp/>

1. Start Document Capture Pro.
2. Click **Job Settings** on the **Job Scan** screen.

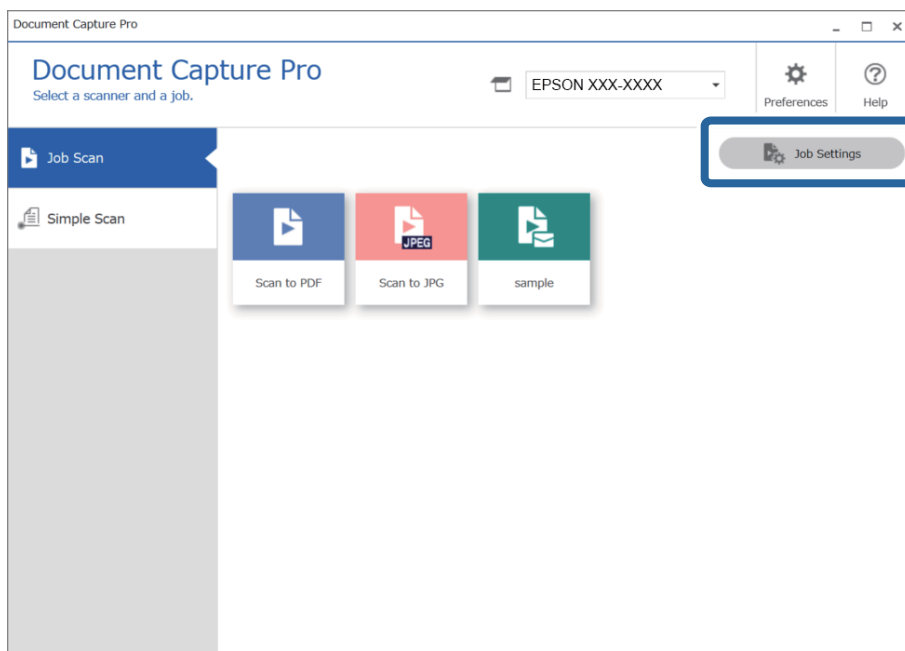

3. Click **New Job**.

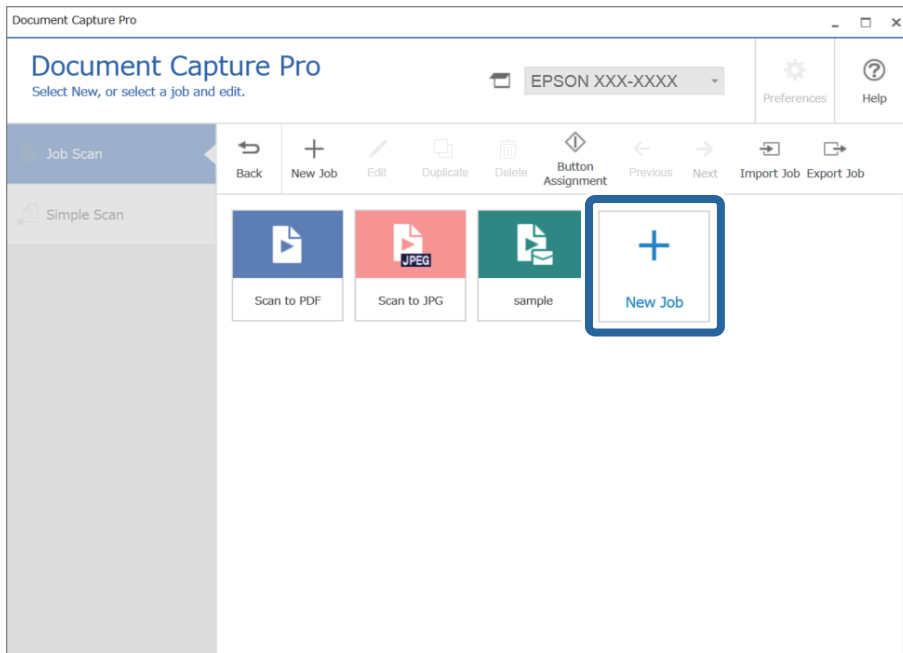

Note:

To create a new job based on another job, click the job you want to use as the base, and then click **Duplicate**.

The **Job Settings** window is displayed.

4. Enter a **Job Name**.

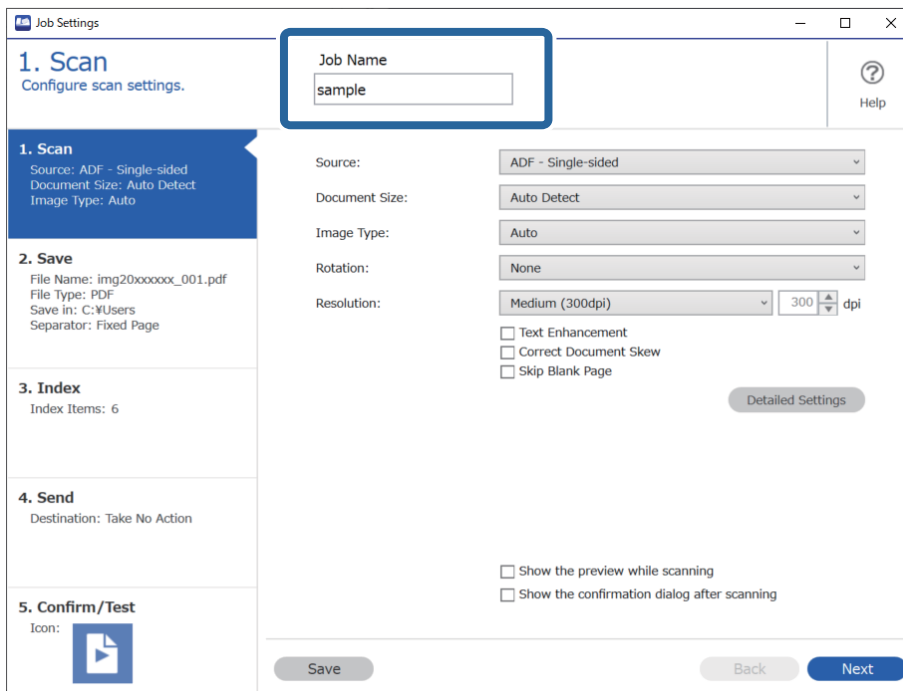

5. On the **1. Scan** tab, set the scan job operations you want to create.

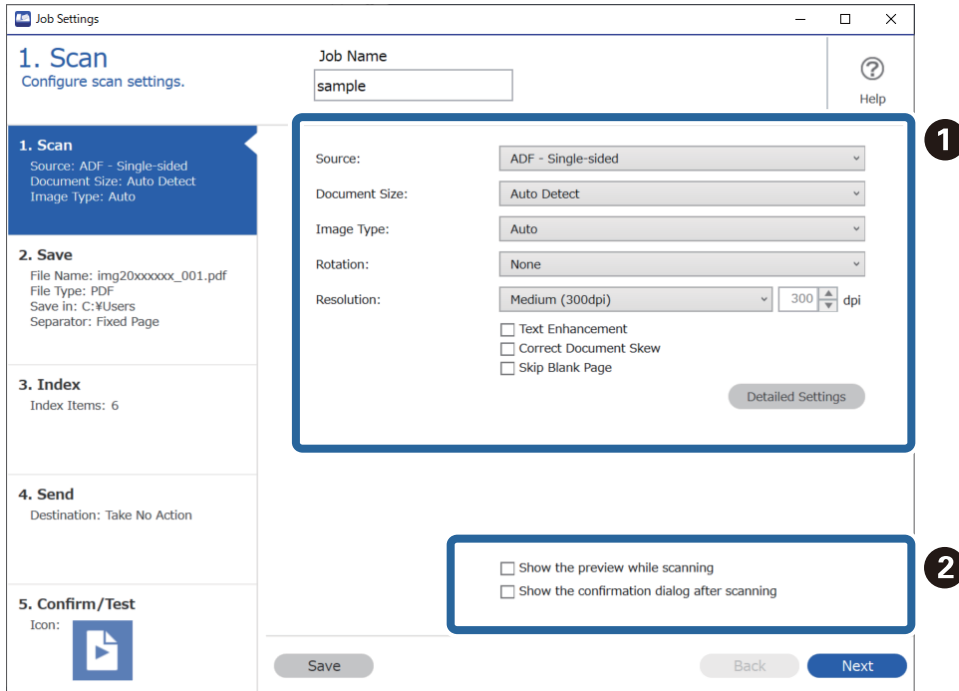

- ❶ Make basic scanning settings.

To make more advanced settings, click **Detailed Settings** to open the settings screen. Change the scan operation and click **Save** to return to the Document Capture Pro screen.

- ❷ Change the settings as necessary.

Select **Show the preview while scanning** to display images while scanning.

Select **Show the confirmation dialog after scanning** to display a confirmation message asking if you want to continue scanning after completing a scan.

When you have finished making scanning settings, click **Next** or the **2. Save** tab.

6. On the **2. Save** tab, you can make settings for saving the scan results.

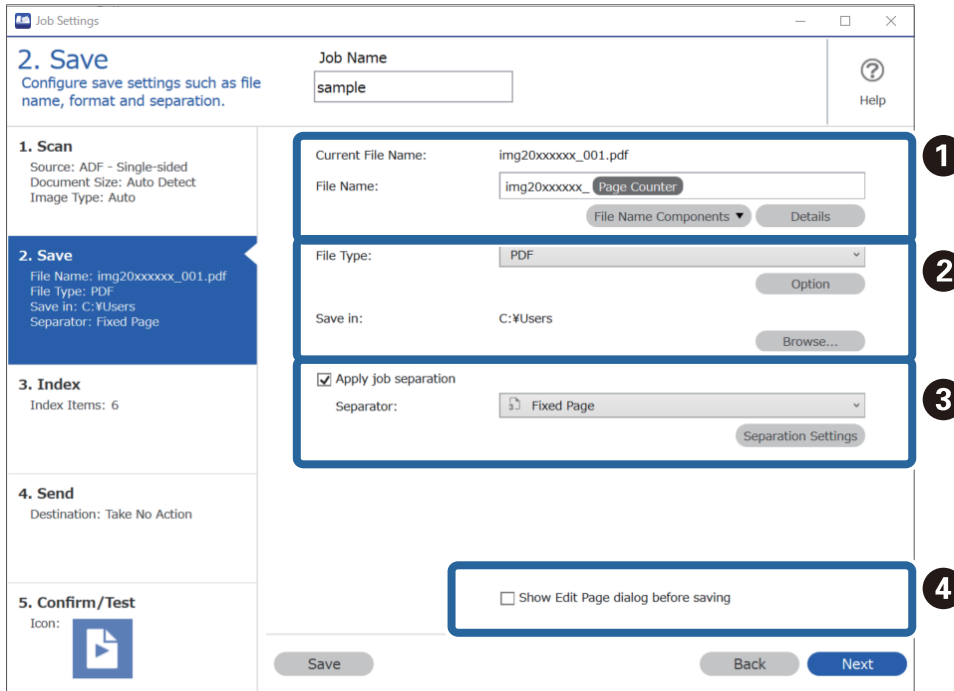

- ❶ Set the name of the file.

When you select a component you want to use for the file name from **File Name Components**, it is added to the file name. You can also enter a name directly in **File Name**.

If you want to add barcodes, OCR, and forms, you need to make settings in advance. Click **Detailed Settings**.

You can also change the Time Stamp and Page Counter format from **Detailed Settings**.

- ❷ Set the file save format and location.

Option may be enabled depending on the File Type; click to make detailed settings.

- ❸ When you want to separate jobs, select this to choose the separation method, and then select **Separation Settings** to make detailed settings.

- ❹ Change the settings as necessary.

When you select **Show Edit Page dialog before saving**, you can make edits on the **Edit Scanned Results** screen after scanning.

When you have finished making save settings, click **Next** or the **3. Index** tab.

7. You can make index file settings on the **3. Index** tab.

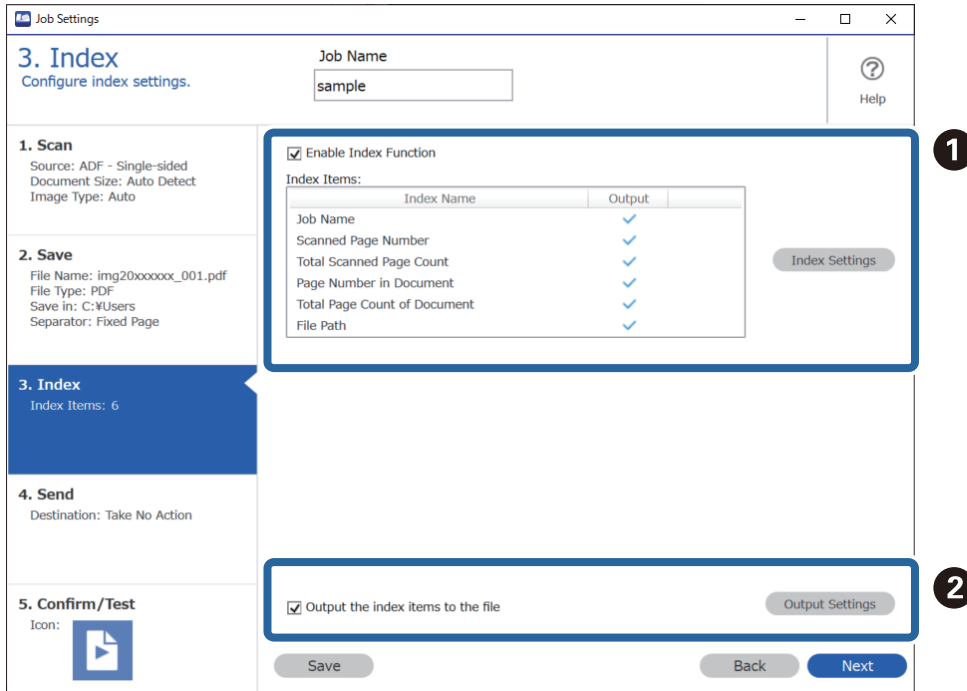

- ❑ **1** When creating an index file, select **Enable Index Function**.
Click **Index Settings** and select the items you want to use for the index.
- ❑ **2** Select **Output the index items to the file**, and then click **Output Settings** to set the output items and file name used when outputting to a file.

When you have finished making index settings, click **Next** or the **4. Send** tab.

- Set the destination settings on the **4. Send** tab.

When **Destination** is selected, setting items are displayed according to the send destination.

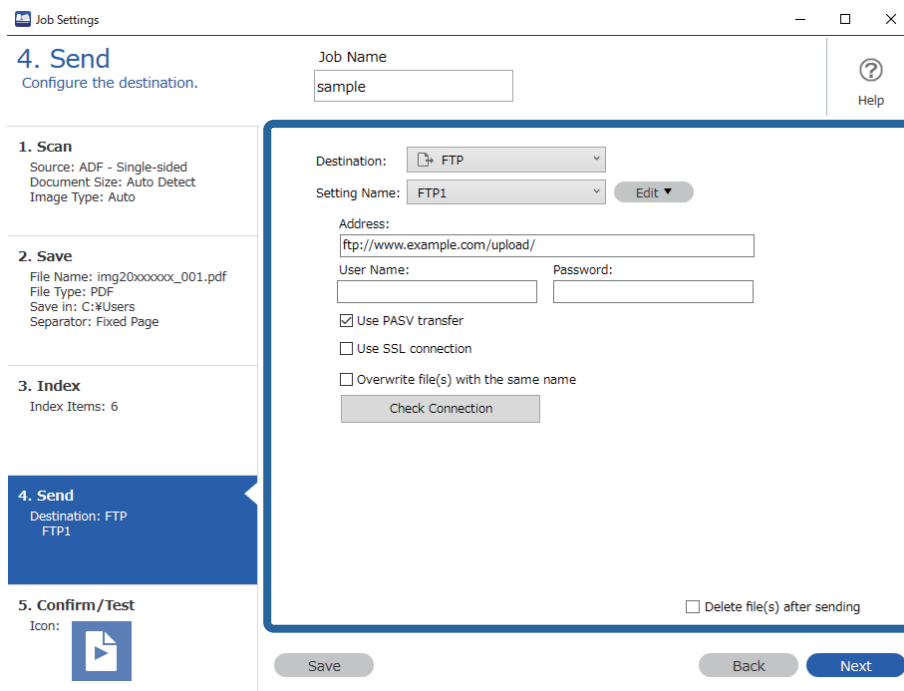

When you have finished making transfer settings, click **Next** or the **5. Confirm/Test** tab.

- Check the settings on the **5. Confirm/Test** tab, and then perform a test scan.

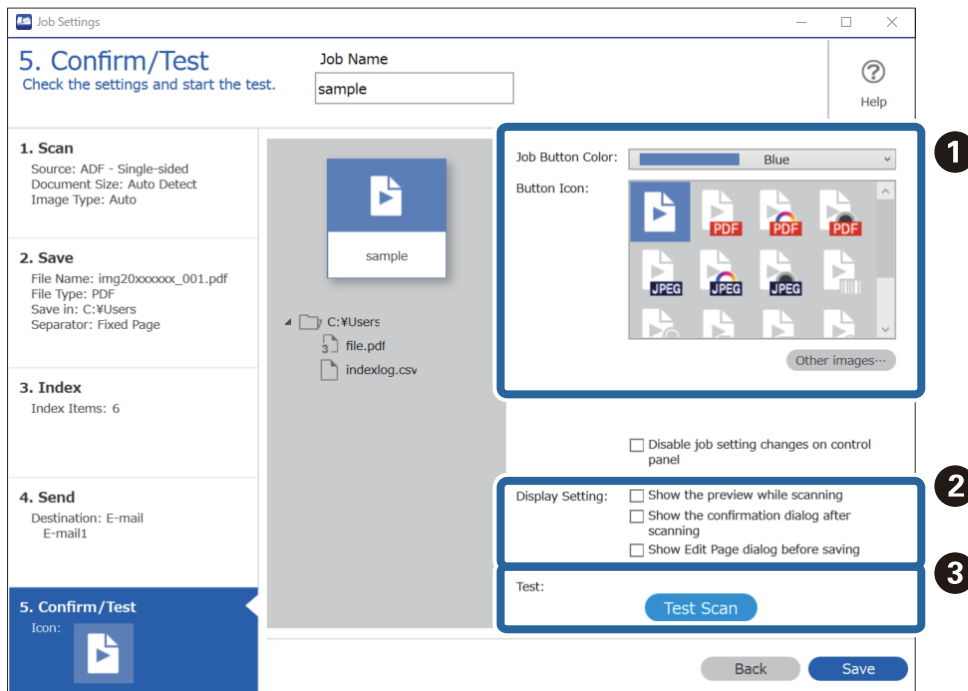

- ① Change the job button color or icon.
- ② Change the display settings used during and after scanning.

- ❑ ③ Perform a test scan using the job that is currently set.

10. Click **Save** to finish creating the job.

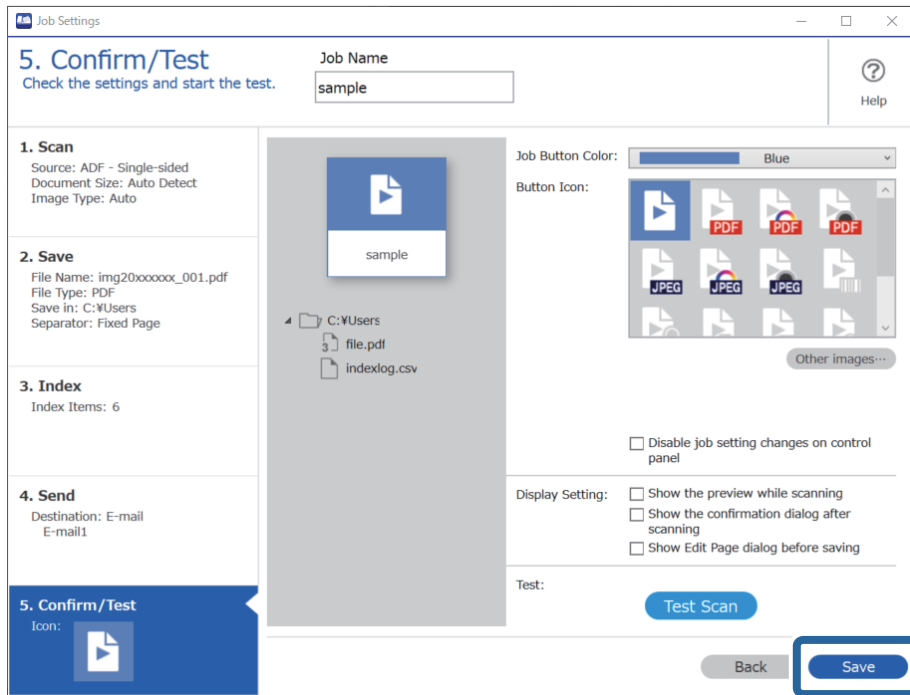

If you go on to create a new job, make edits, duplicate, delete, and so on, continue to make settings. To finish making job settings, click the **Back** button on the left of the toolbar to return the job screen.

Creating and Registering a Job (Mac OS)

Explains how to set a job in Document Capture. See the Document Capture help for details on the features.

1. Start Document Capture.
2. Click the  icon on the main window.
The **Job List** window is displayed.
3. Click the + icon.
The **Job Settings** window is displayed.
4. Make the job settings on the **Job Settings** window.
 - ❑ **Job Name:** Enter the name of the job you want to register.
 - ❑ **Scan:** Make scan settings such as the size of the originals or the resolution.
 - ❑ **Output:** Set the saving destination, the saving format, the naming rules of the files, and so on.
 - ❑ **Destination:** Select the destination of the scanned images. You can send them by email or forward them to an FTP server or Web server.

5. Click **OK** to return to the **Job List** window.
The created job is registered in the **Job List**.
6. Click **OK** to return to the main window.

Enabling a Job to Run from the Control Panel (Button Assignment)

By assigning a job to the scanner's control panel in advance using Document Capture Pro (Windows), Document Capture (Mac OS) or Document Capture Pro Server (Windows Server), you can run jobs from the control panel.

Assigning a Job to the Control Panel (Windows)

Explains how to assign a job to the scanner's control panel in Document Capture Pro. See the Document Capture Pro help for details on the features.

<https://support.epson.net/dcp/>

1. Start Document Capture Pro.
2. Click **Job Settings** on the Job Scan screen.

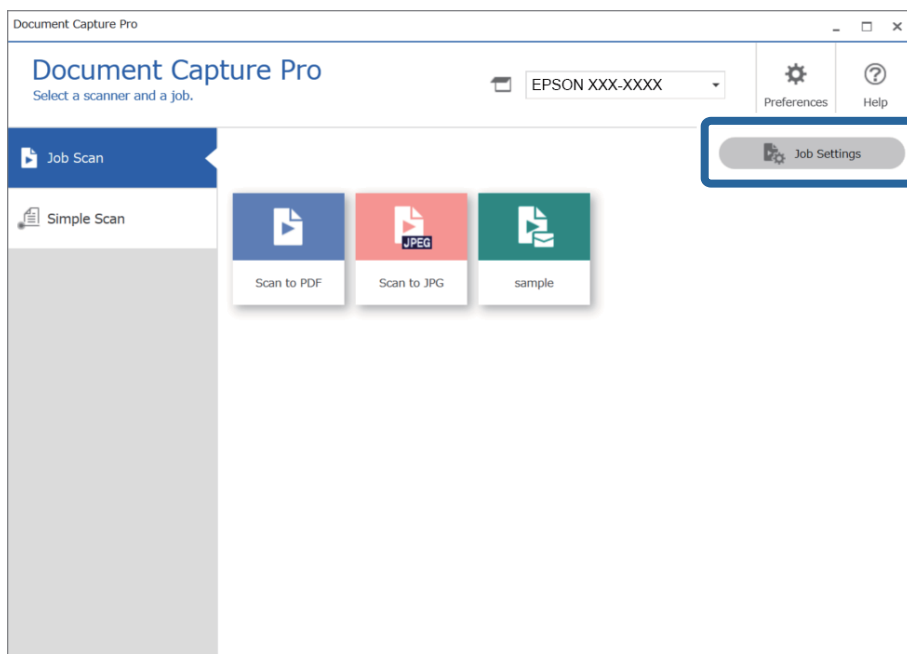

3. Click **Button Assignment**.

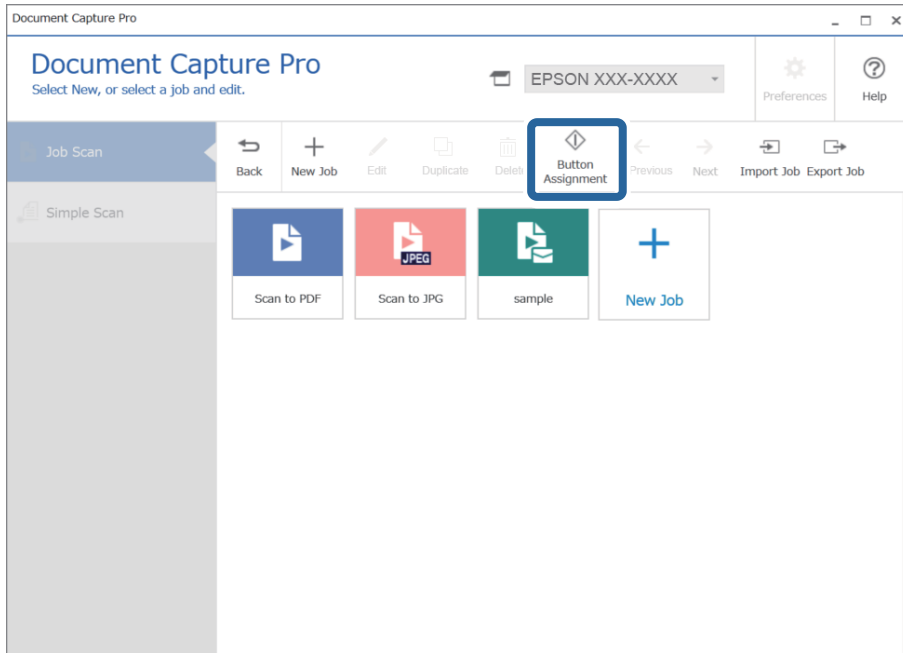

The button assigning screen is displayed.

4. From the pull down menu, select the job you want to perform from the control panel (buttons) on the scanner.

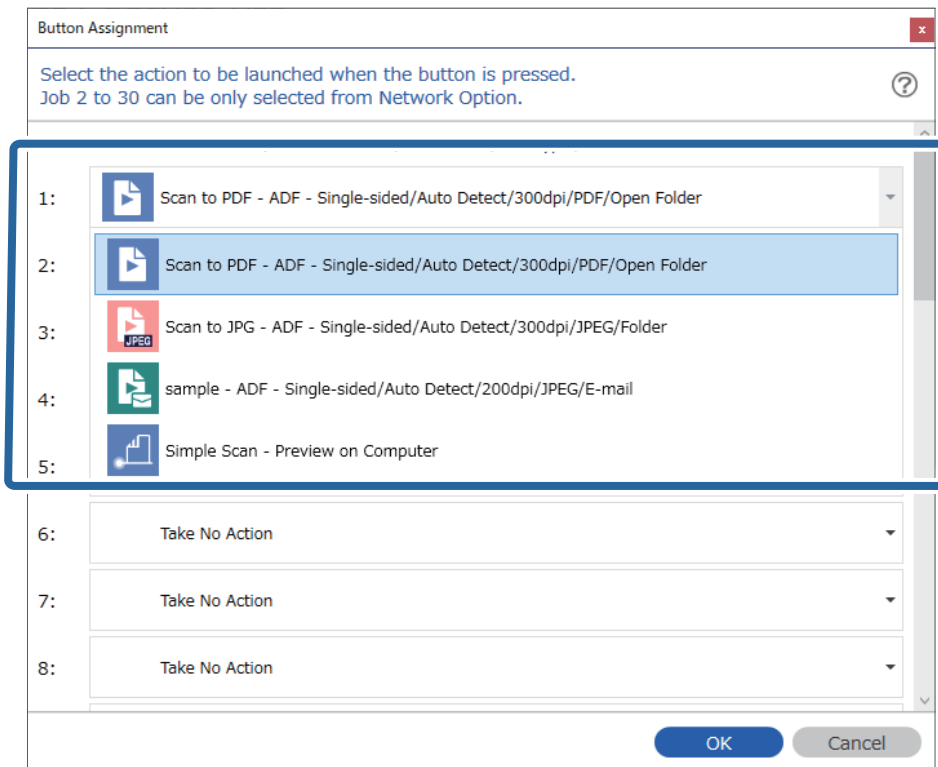



5. Click **OK** to close the Button Assignment screen.

Related Information

➔ [“Scanning Originals to a Computer” on page 93](#)

Assigning a Job to the Control Panel (Mac OS)

Explains how to assign a job to the scanner’s control panel in Document Capture. See the Document Capture help for details on the features.

1. Start Document Capture.
2. Click the  icon on the main window.
The **Job List** window is displayed.
3. Click the  icon and select **Event Settings**.
4. Select the job you want to run on the control panel from the pull-down menu.
5. Click **OK** to return to the **Job List** window.
The job is assigned to the scanner’s control panel.
6. Click **OK** to return to the main window.

Related Information

➔ [“Scanning Originals to a Computer” on page 93](#)

Scanning Different Sizes or Types of Originals One by One (Automatic Feeding Mode)

You can scan different sizes or types of originals one by one using Automatic Feeding Mode. In this mode, the scanner starts scanning automatically when originals are loaded in the ADF.

When you are using **Document Capture Pro**, you can also use Automatic Feeding Mode.

1. Start Epson Scan 2.

Note:

*When you are using Document Capture Pro, you can open the Epson Scan 2 window by pressing the **Detailed Settings** button on the **Scan Settings** screen.*

2. Select **Automatic Feeding Mode** on the **Main Settings** tab.

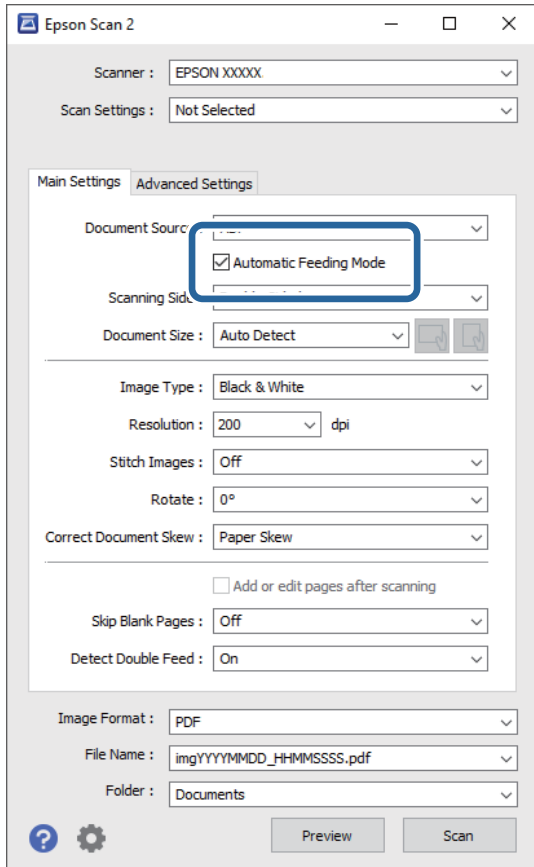

3. Make other settings for scanning in the Epson Scan 2 main window.
4. Click **Scan**.

Note:

When you are using Document Capture Pro, click **Save** to save the scan settings. When you start scanning, *Automatic Feeding Mode* starts.

Automatic Feeding Mode starts.

The **Automatic Feeding Mode** window is displayed on your computer and the scanner.

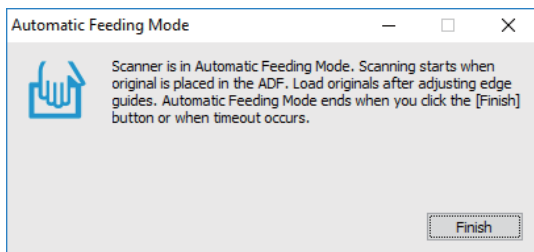

5. Adjust the edge guides, and then place the original in the ADF.
Scanning starts automatically.

6. After scanning stops, place the next original in the ADF.
Repeat this procedure until you have scanned all originals.

Note:

Press the ▼ button to make **Scanner Settings**.

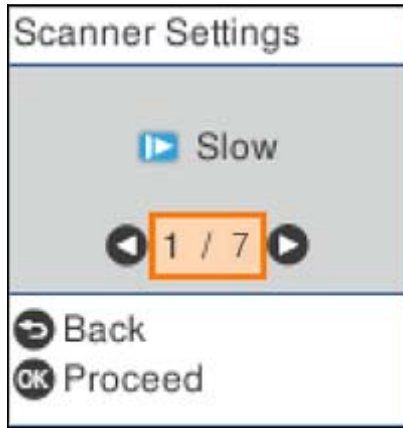

- **Slow:** Slows down the scanning speed. Use this to scan originals that are likely to jam, for example thin paper.
- **DFDS Function:** Skips double feed detection once and continues scanning. Use this to scan originals that are detected as double feeds, for example plastic cards or envelopes.
- **Paper Protection:** Reduces damage to the originals by stopping scanning immediately when a feeding error occurs.
- **Detect Glass Dirt:** Detects dirt on the glass surface inside the scanner.

7. After you have scanned all originals, close Automatic Feeding Mode.

Press the ⏏ button on the scanner or press **Finish** on the **Automatic Feeding Mode** screen displayed on your computer.

Note:

You can make timeout settings to exit **Automatic Feeding Mode**.

Select **Settings** on the **Document Source** list to open the **Document Source Settings** screen. Set **Automatic Feeding Mode Timeout (minutes)** on the screen displayed.

The scanned image is saved to the folder you specified.

Related Information

➔ [“Placing Originals” on page 33](#)

Various Scanning Settings for Document Capture Pro (for Windows Only)

Document Capture Pro allows you to easily scan and save documents such as official reports and forms, by using the optimum settings to suit your needs. This section explains how to make settings for jobs that use convenient functions such as sorting.

Note:

This chapter explains the Document Capture Pro feature on Windows. When you using Document Capture on Mac OS, see the software help for details.

Related Information

- ➔ “Dividing documents using a specified number of pages” on page 127
- ➔ “Dividing documents using blank sheets of paper” on page 130
- ➔ “Creating and saving folders using the barcode character information” on page 133
- ➔ “Creating two levels of folders using two types of barcode” on page 138
- ➔ “Saving files with file names using the barcode character information” on page 142
- ➔ “Creating and saving folders using OCR characters” on page 146
- ➔ “Saving files with file names using OCR characters” on page 151
- ➔ “Creating and saving folders for each form” on page 158

Dividing documents using a specified number of pages

You can divide data based on a specified number of pages scanned, and save in a file or folder.

This section explains the job settings for "Dividing a document every three pages and saving as PDF files".

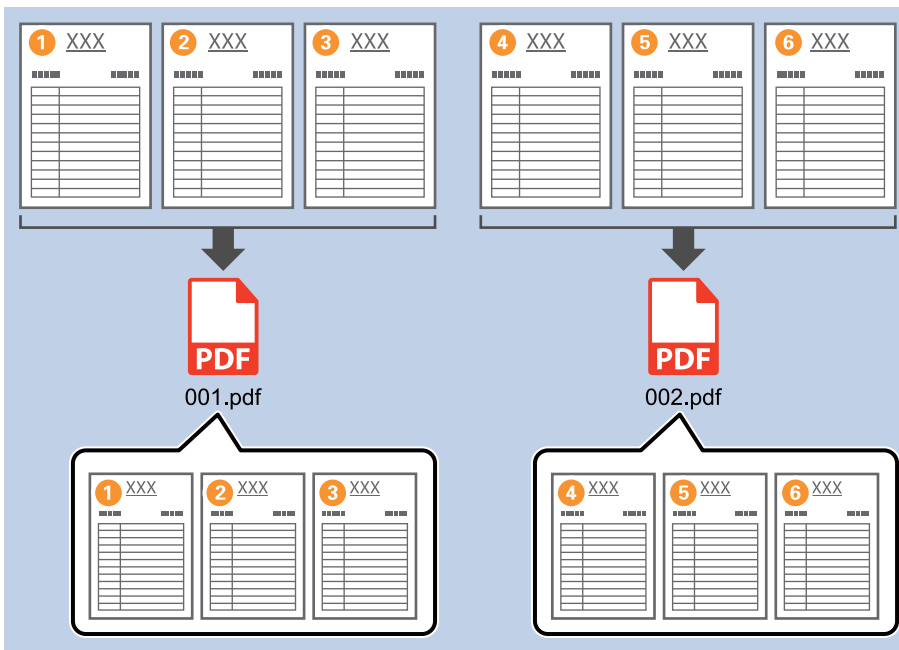

1. Display the **Job Settings** screen, and then click the **2. Save** tab.

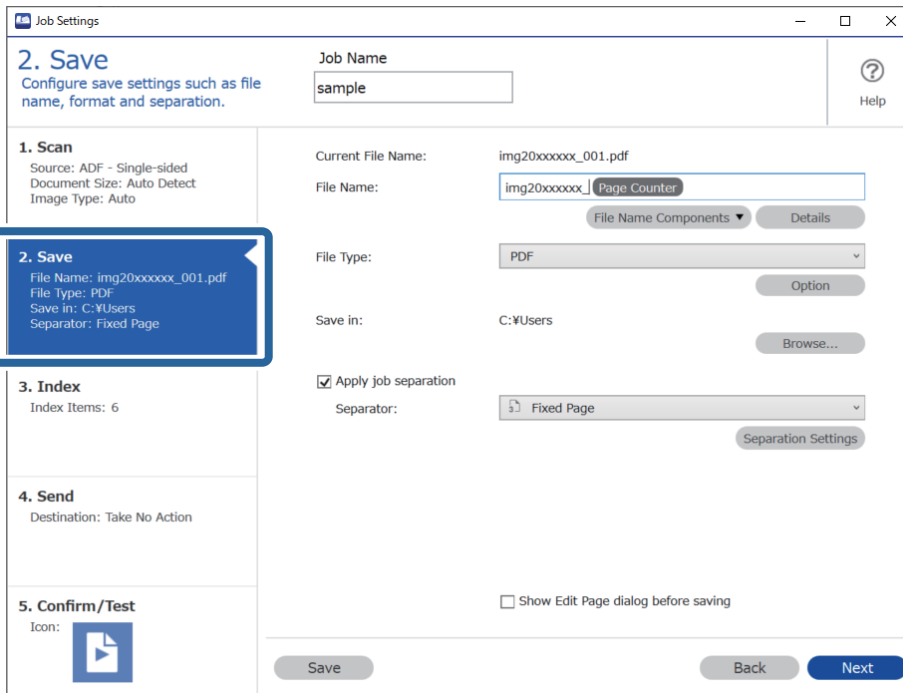

2. Set **File Type** to PDF.

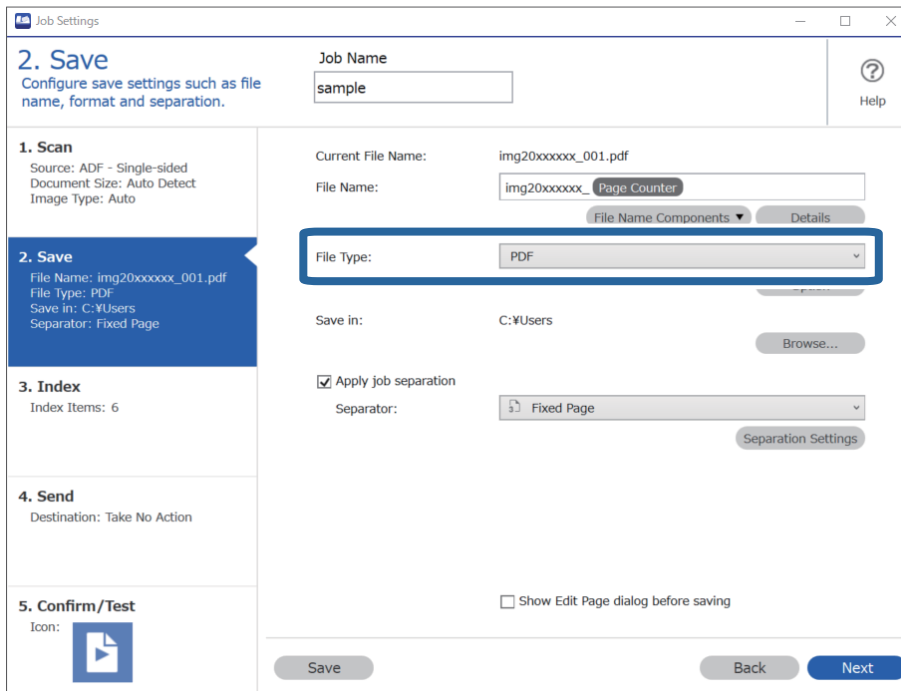

3. Select **Apply job separation**, set **Separator** to **Fixed Page**, and then click **Separation Settings**.

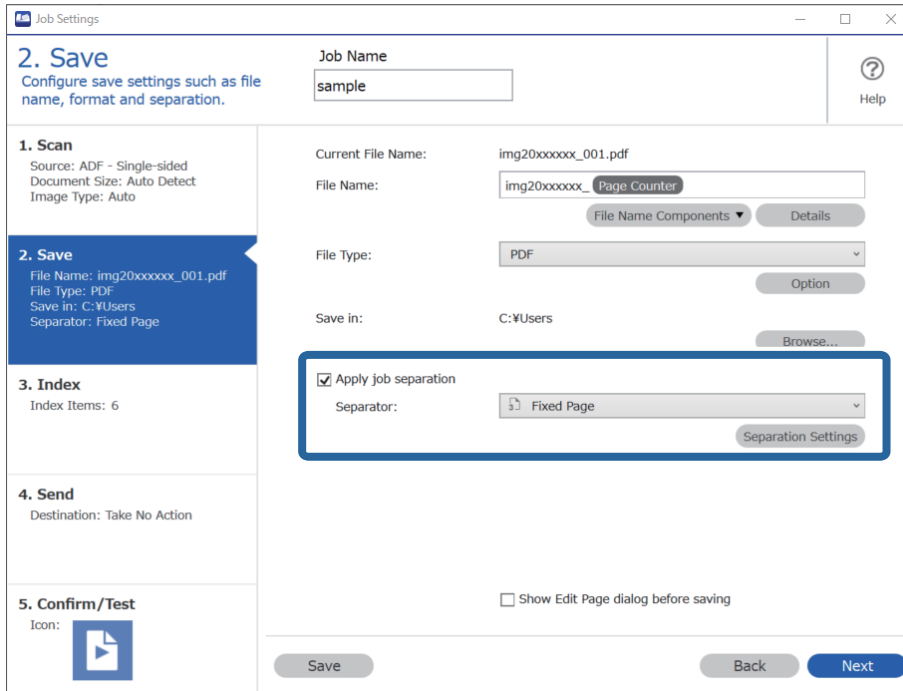

4. On the **Job Separation Settings** screen, set the number of pages at which you want to divide the document. For example, when you specify "3", the document is divided after scanning every three pages.

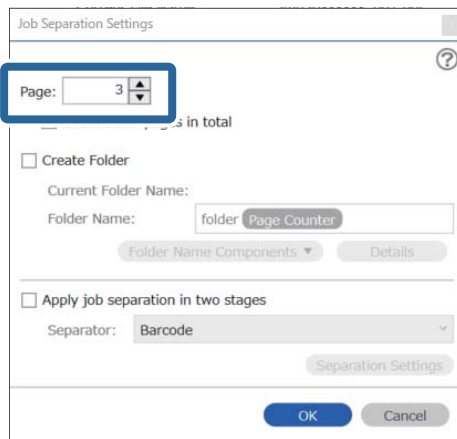

Note:

Since there are no save formats (image files such as JPEGs) that support multiple pages, you cannot create multi-page files. When **Create Folder** is selected, the document is divided at the page number you specified (number of files), and then saved to a folder.

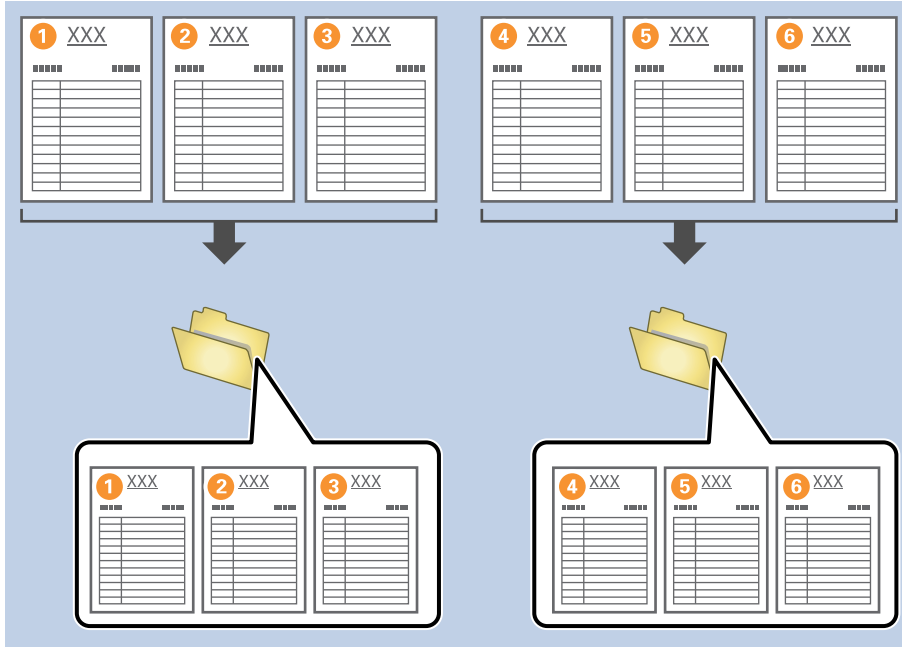

Dividing documents using blank sheets of paper

By placing blank sheets of paper between the pages of the document being scanned, you can divide the scanned data and save them in separate files or folders. When scanning both sides of a document, if one of the sides is blank, it is also detected as a blank page. After sorting, you can remove any unnecessary pages and then save.

This section explains the job settings for "Dividing a document using blank pages, and saving as PDF files" when a blank page is placed between the third and fourth pieces of paper.

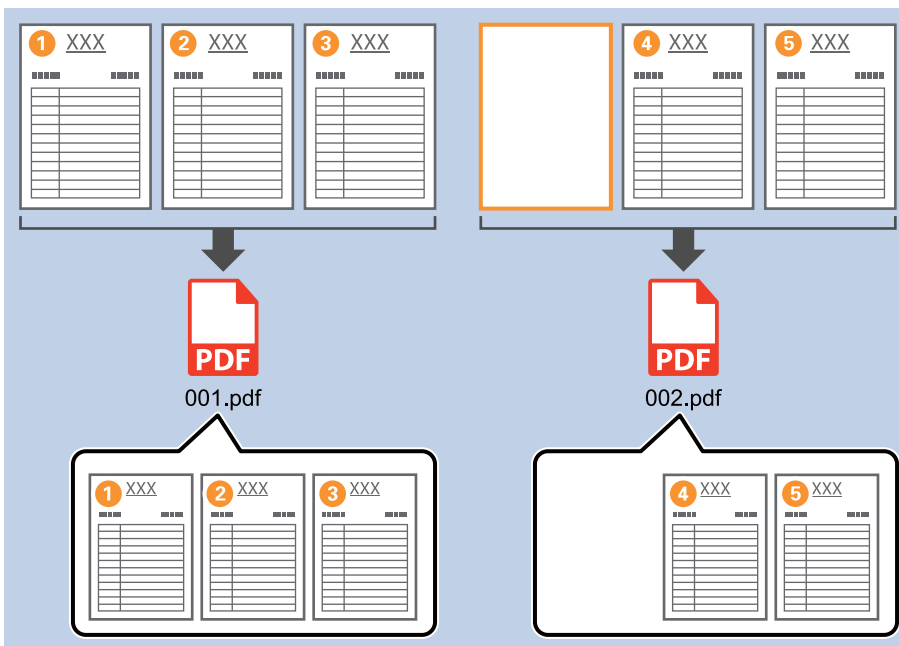

1. Display the **Job Settings** screen, and then click the **2. Save** tab.

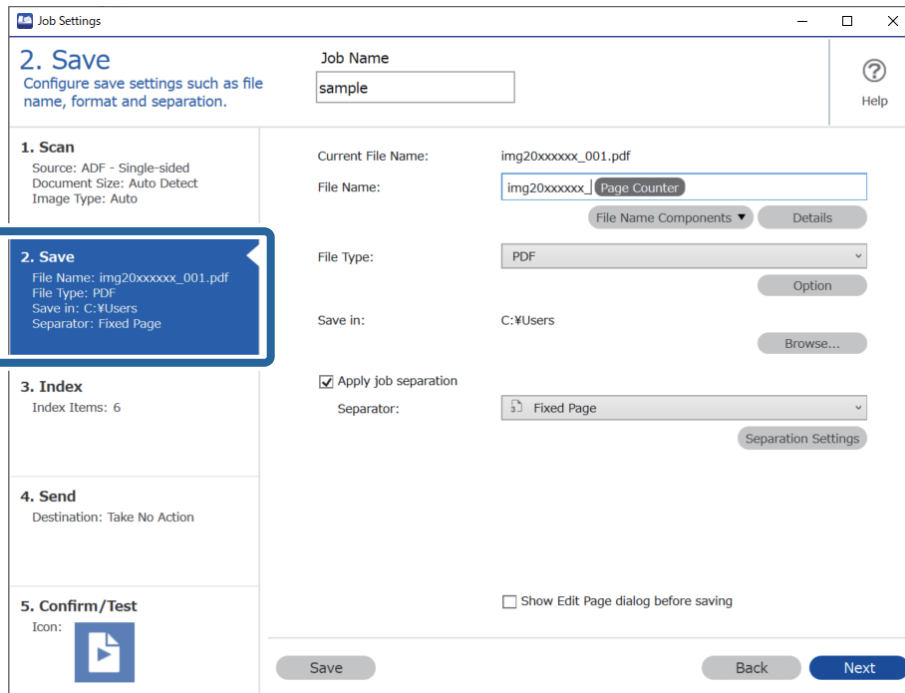

2. Set **File Type** to PDF.

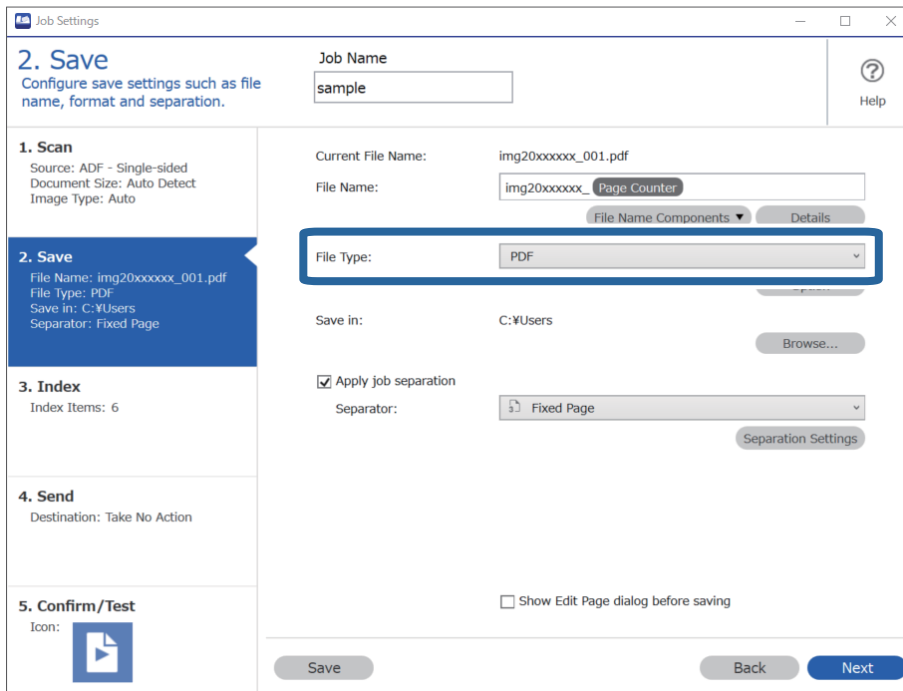

3. Select **Apply job separation**, set **Separator** to **Blank Page**, and then click **Separation Settings**.

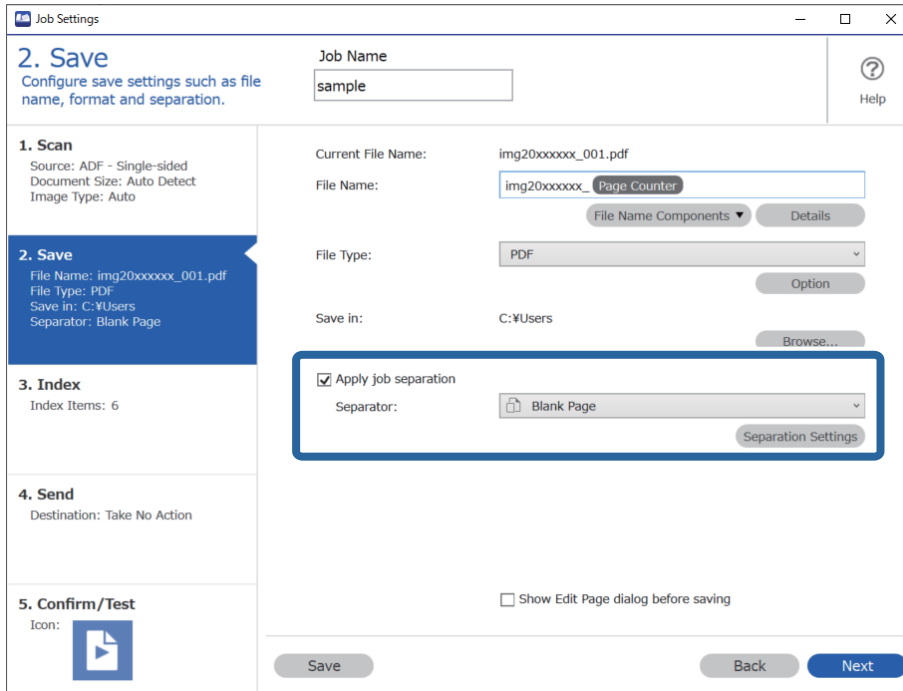

4. On the **Job Separation Settings** screen, select **Delete a page for separator**.
Blank pages are removed after sorting.

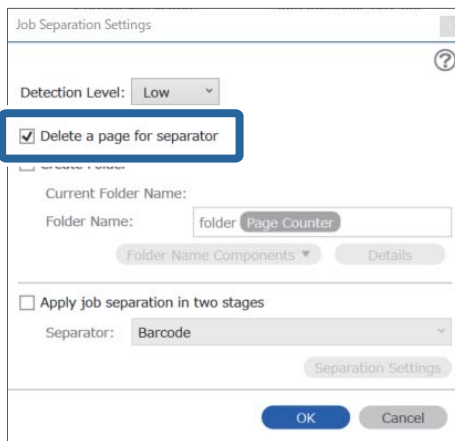

Note:

- ❑ If you also need to save the blank pages, clear **Delete a page for separator**. However, the first page of each separated file will be blank.

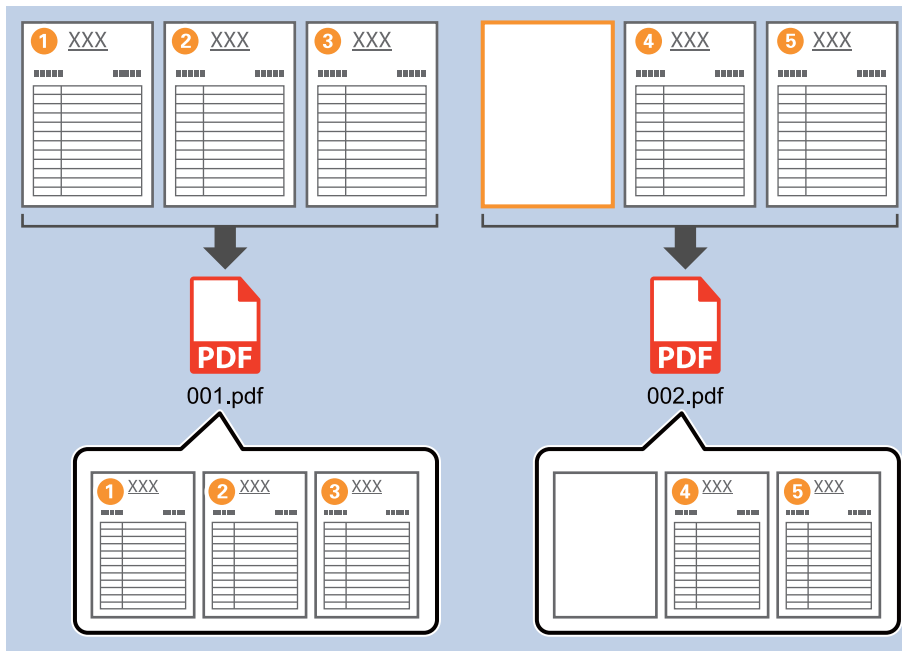

- ❑ In **Detection Level**, you can select the detection level from **High**, **Medium**, or **Low**. When the level is high, light color documents and documents with show through are detected as blank pages.
- ❑ When the **Source** is set to **Double-sided** from **Scan Settings**, the **Include the back page during duplex scanning** item is displayed. When this is selected, you can also divide by using the back of a page if it is blank when scanning both sides of a document.

Creating and saving folders using the barcode character information

Using the barcode information, you can divide files by each page on which a barcode is detected, and you can create and save folders using the text information in the barcode.

This section explains the job settings for "Sorting by barcode, and saving folder names using the text information in the barcode".

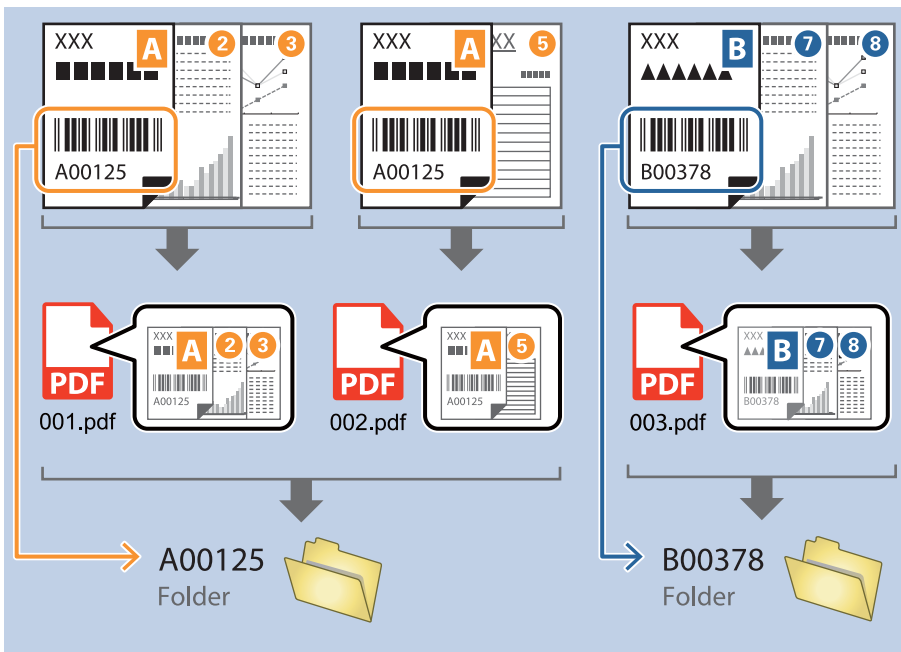

1. Display the **Job Settings** screen, and then click the **2. Save** tab.

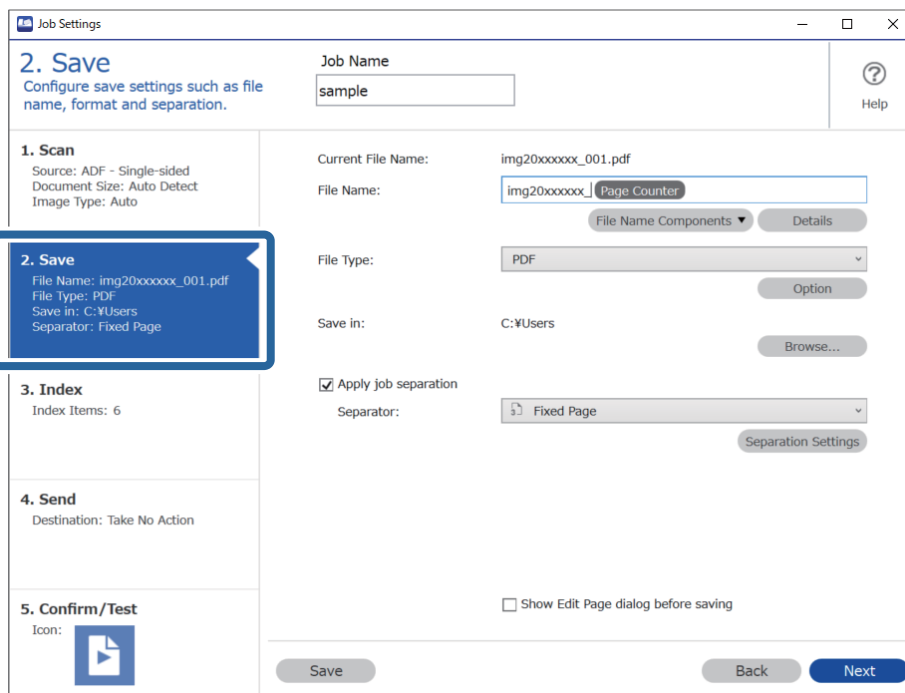

2. Select **Apply job separation**, set **Separator** to **Barcode**, and then click **Separation Settings**.

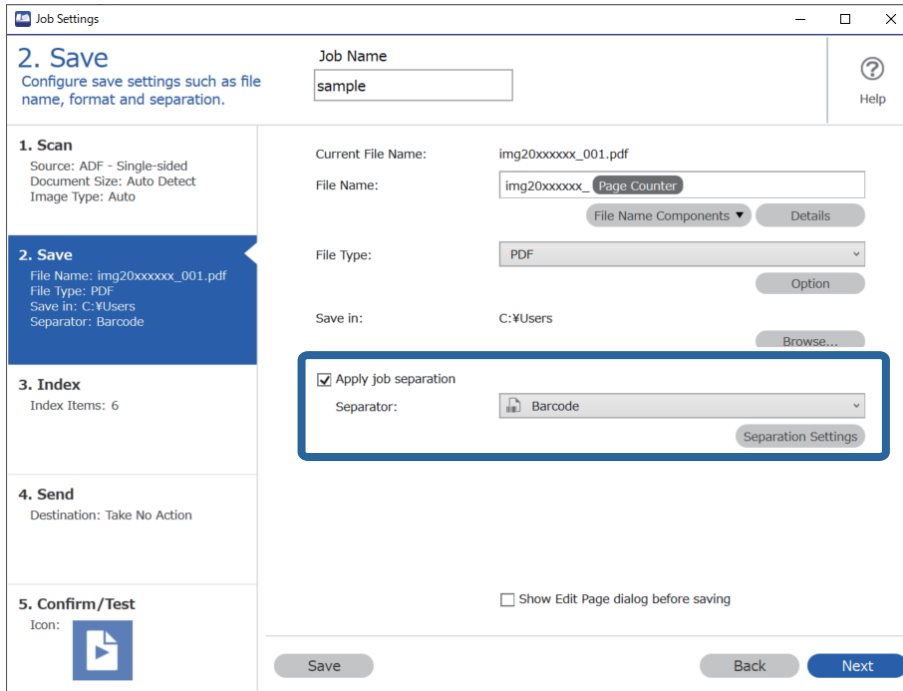

3. On the **Job Separation Settings** screen, select the type of barcode you want to use. To select individual barcode types, clear **All Barcode Type**.

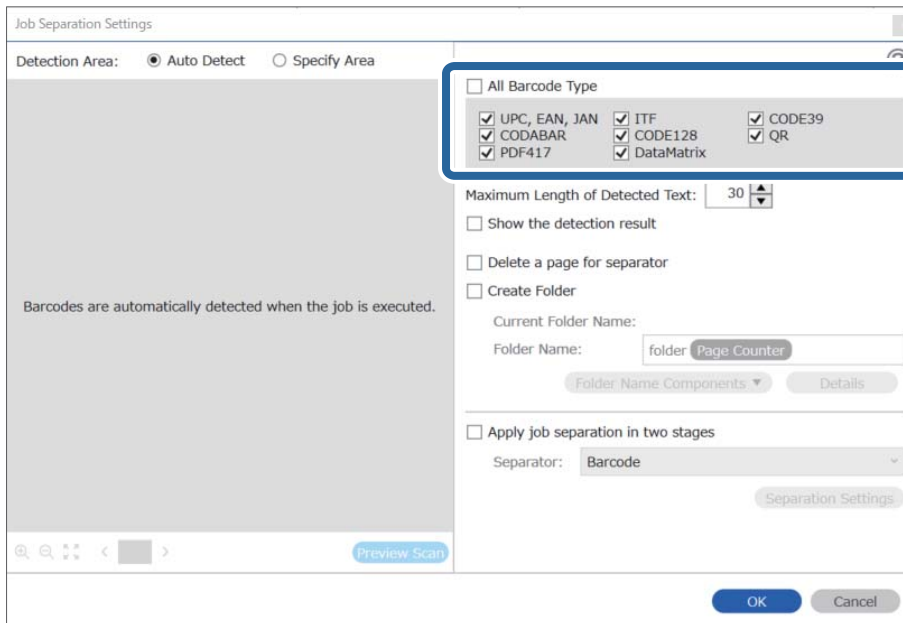

4. Check **Create Folder**, select **Barcode** from **Folder Name Components**.

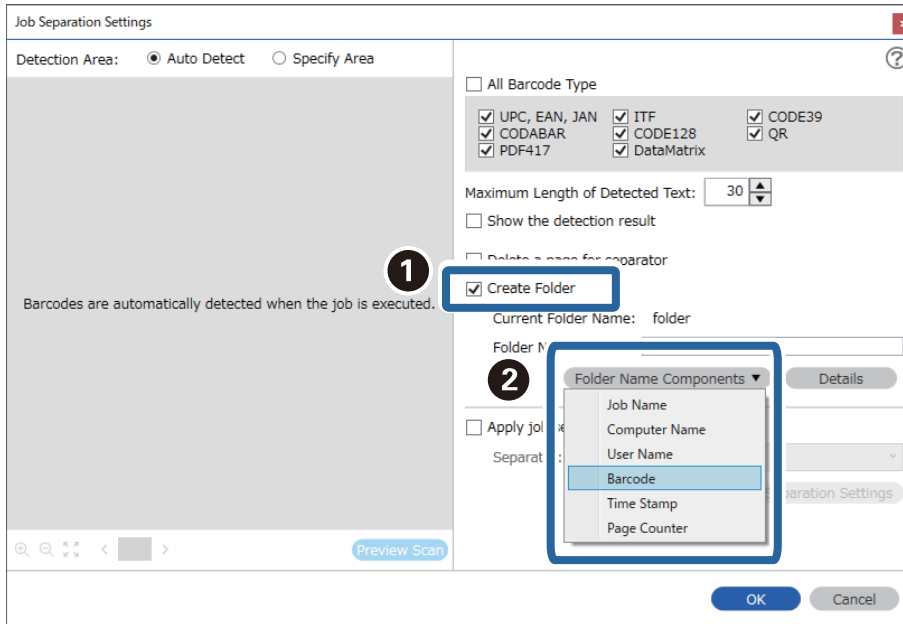

Note:

- ❑ You can specify the point at which the Folder Name Components will be inserted with your cursor.
You can also drag and drop added items to change the order.
To delete added items, select the added item and delete it using the Delete key on your keyboard.
- ❑ When using a 2D barcode that has a large number of informational items, make sure you specify the maximum length of text that can be detected in **Maximum Length of Detected Text**.
- ❑ If you do not need to save the pages with barcodes, select **Delete a page for separator**. Pages with barcodes are then deleted before the data is saved.

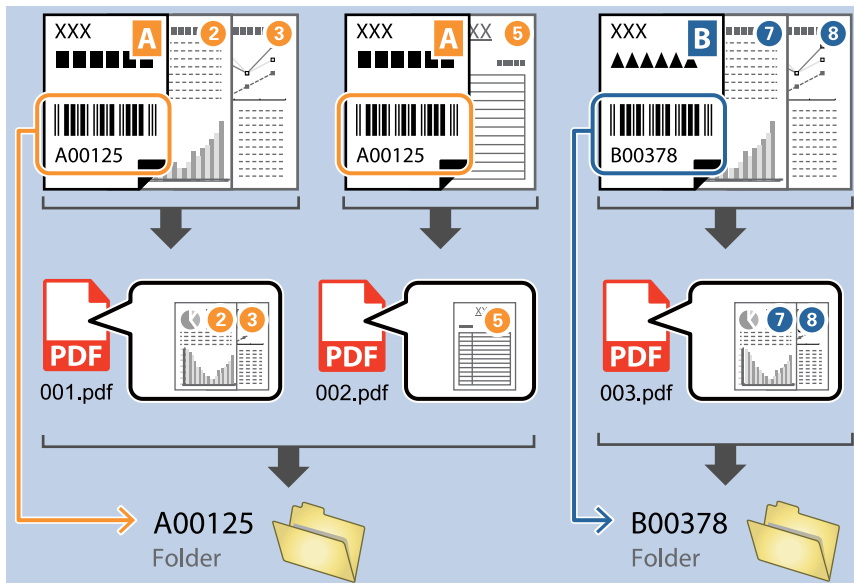

- ❑ Select **Show the detection result** to check whether or not barcode text has been recognized correctly. On the screen displayed after scanning, you can check the area and text that has been recognized. You can also re-specify the area, and correct the text.

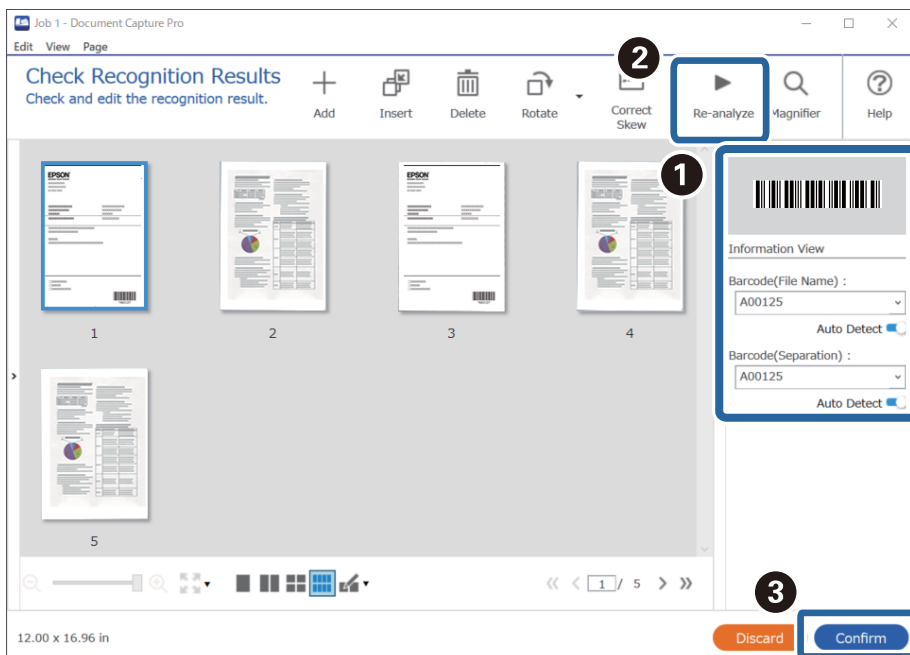

Creating two levels of folders using two types of barcode

You can create and save two levels of folders in a folder tree using two types of barcode information on the documents.

This section explains the job settings for "Creating a folder using the first barcode information, and then creating a folder at a lower level in the folder tree using different barcode information".

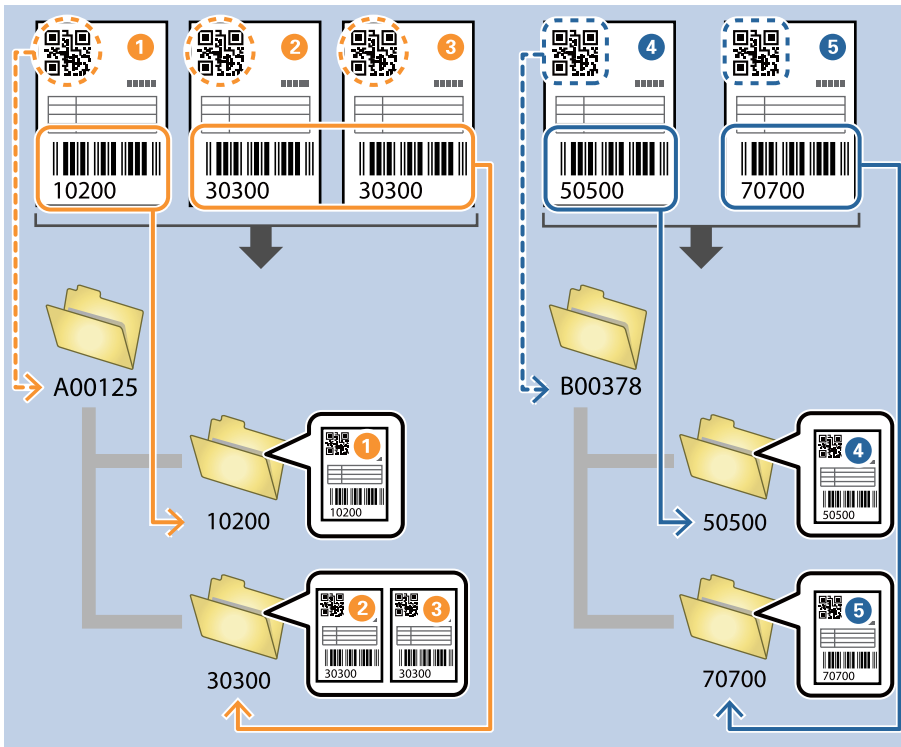

1. Display the **Job Settings** screen, and then click the **2. Save** tab.

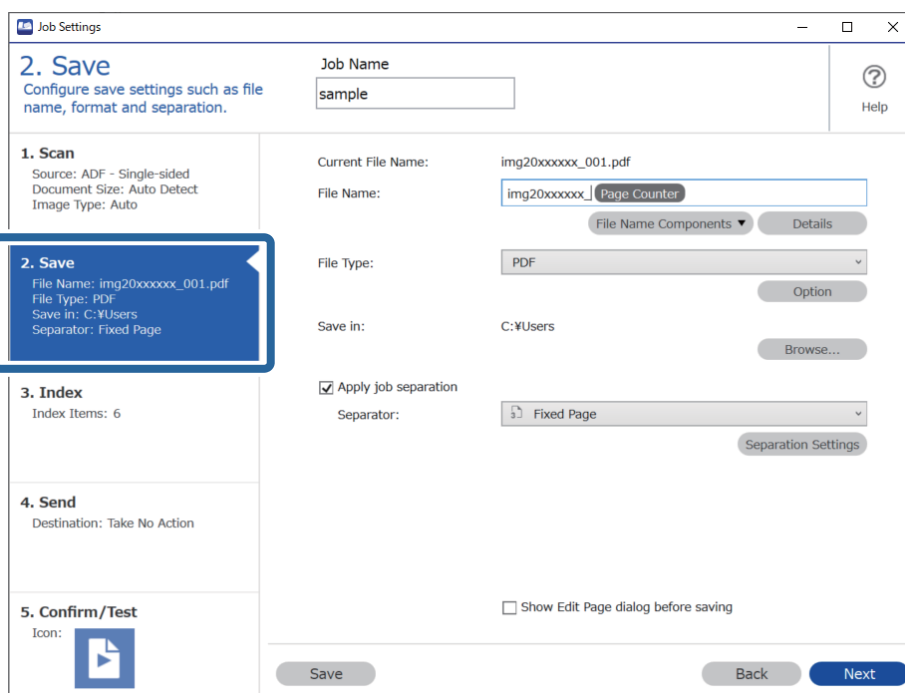

2. Select **Apply job separation**, set **Separator** to **Barcode**, and then click **Separation Settings**.

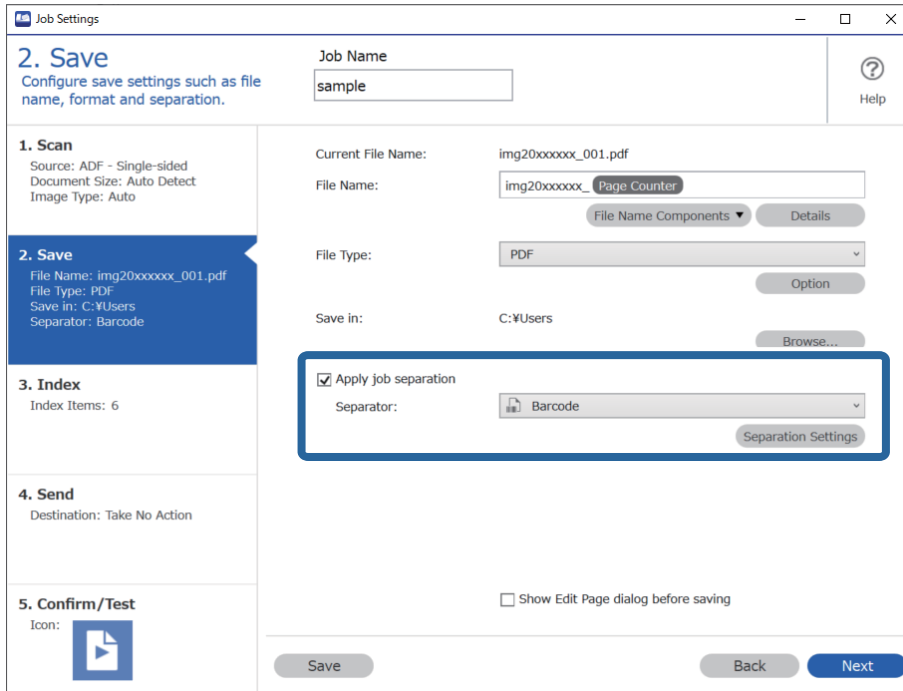

3. On the **Job Separation Settings** screen, select the type of barcode you want to use for the first folder. To select individual barcode types, clear **All Barcode Type**. In this example, the **QR** code has been selected.

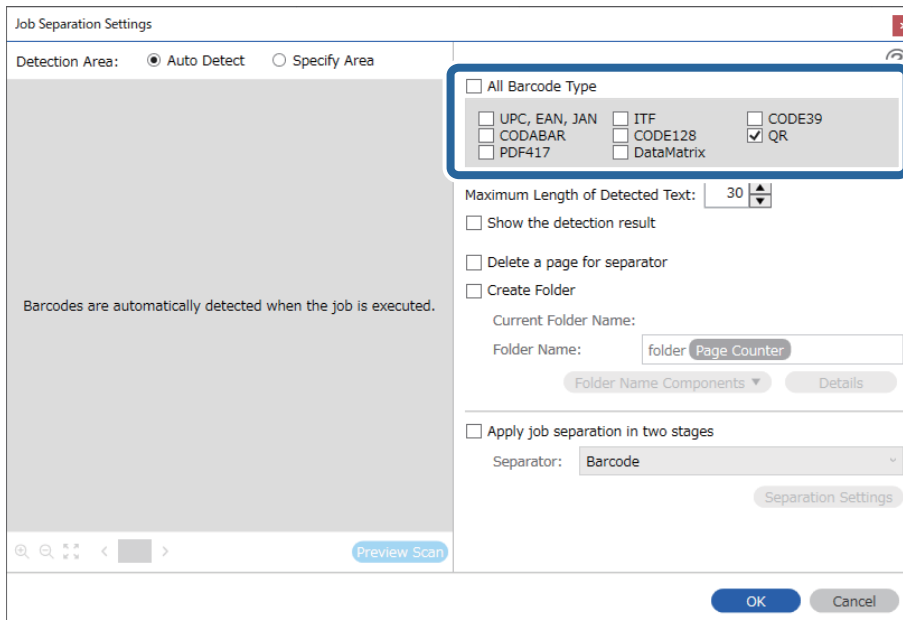

4. Check **Create Folder**, select **Barcode** from **Folder Name Components**.

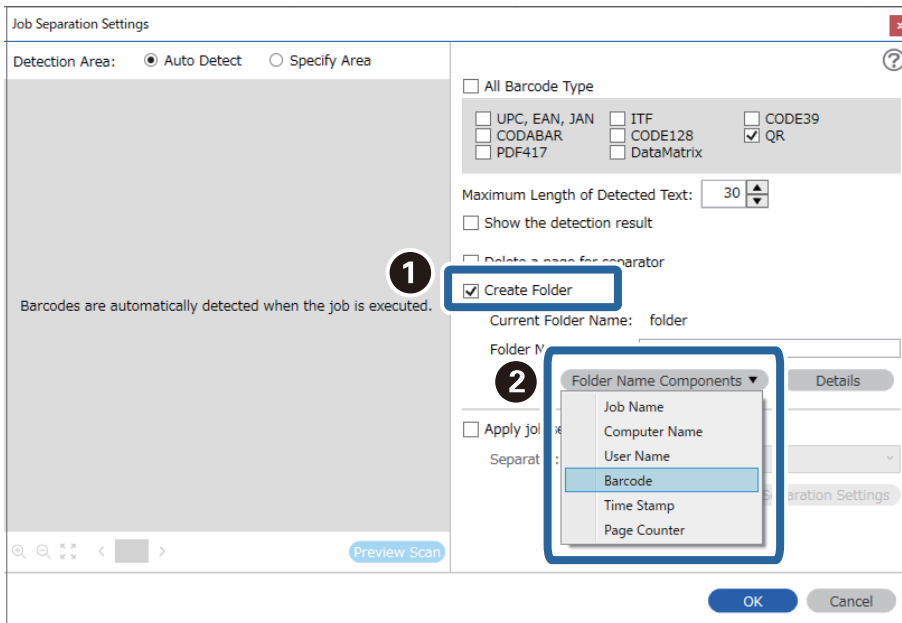

Note:

You can specify the point at which the **Folder Name Components** will be inserted with your cursor.

You can also drag and drop added items to change the order.

To delete added items, select the added item and delete it using the Delete key on your keyboard.

5. Select **Apply job separation in two stages**, set **Separator** to **Barcode**, and then click **Separation Settings**.

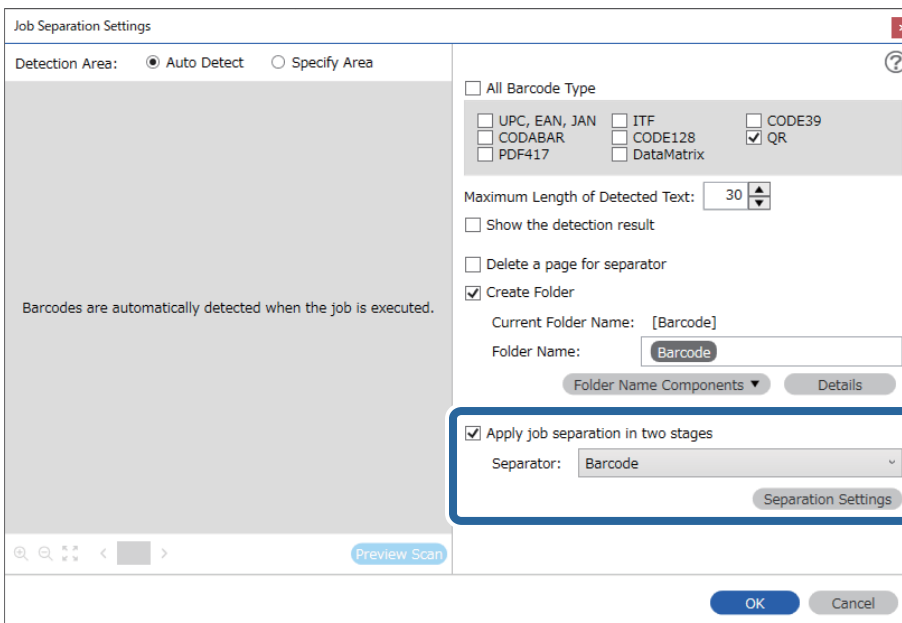

6. Additionally, on the **Job Separation Settings** screen, select the type of barcode you want to use for the second folder, select **Create Folder**, and then select **Barcode** from **Folder Name Components** and add to **Folder Name**.

To select individual barcode types, clear **All Barcode Type**.

In this example, CODE128 has been selected.

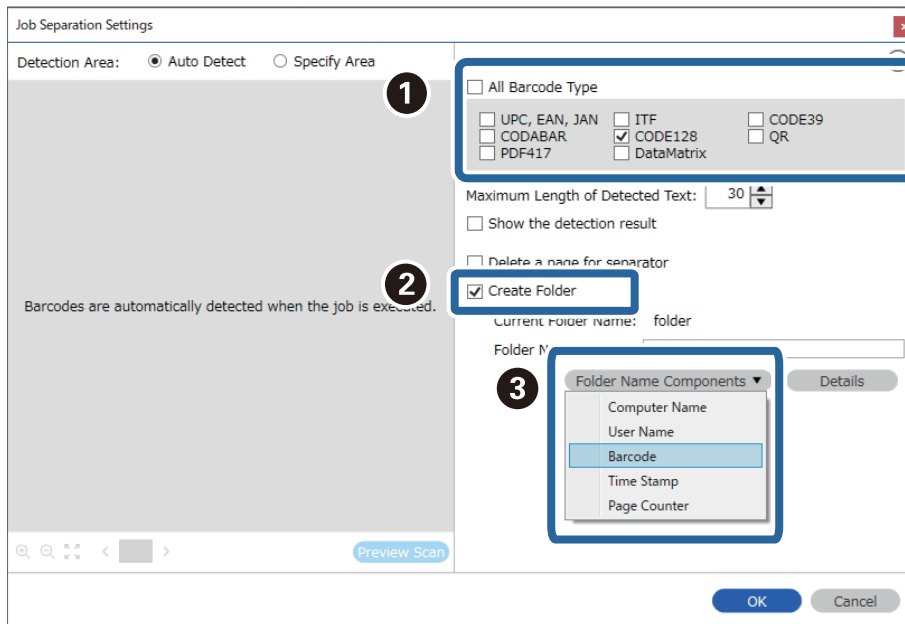

Note:

- ❑ You can specify the point at which the **Folder Name Components** will be inserted with your cursor. You can also drag and drop added items to change the order. To delete added items, select the added item and delete it using the Delete key on your keyboard.
- ❑ When using a 2D barcode that has a large number of informational items, make sure you specify the maximum length of text that can be detected in **Maximum Length of Detected Text**.
- ❑ Select **Show the detection result** to check whether or not barcode text has been recognized correctly. On the screen displayed after scanning, you can check the area and text that has been recognized. You can also re-specify the area, and correct the text.

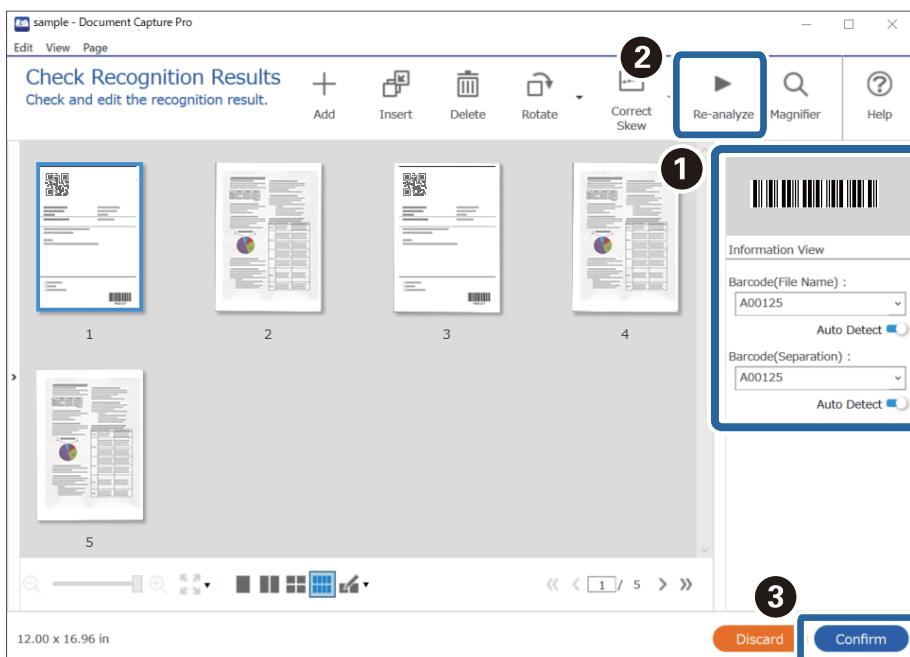

Saving files with file names using the barcode character information

Using the barcode information, you can divide files by each page on which a barcode is detected, and you can create and save folders using the text information in the barcode.

This section explains the job settings for "Sorting by barcode, and saving files with file names using the text information in the barcode".

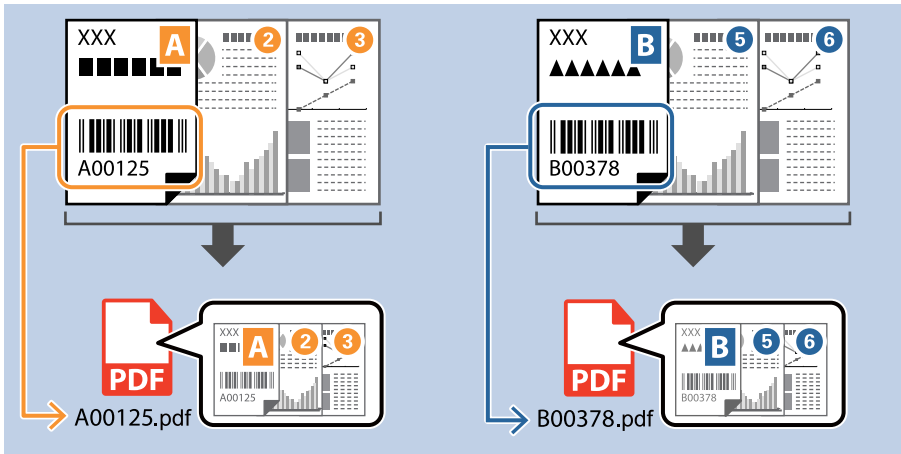

1. Display the **Job Settings** screen, and then click the **2. Save** tab.

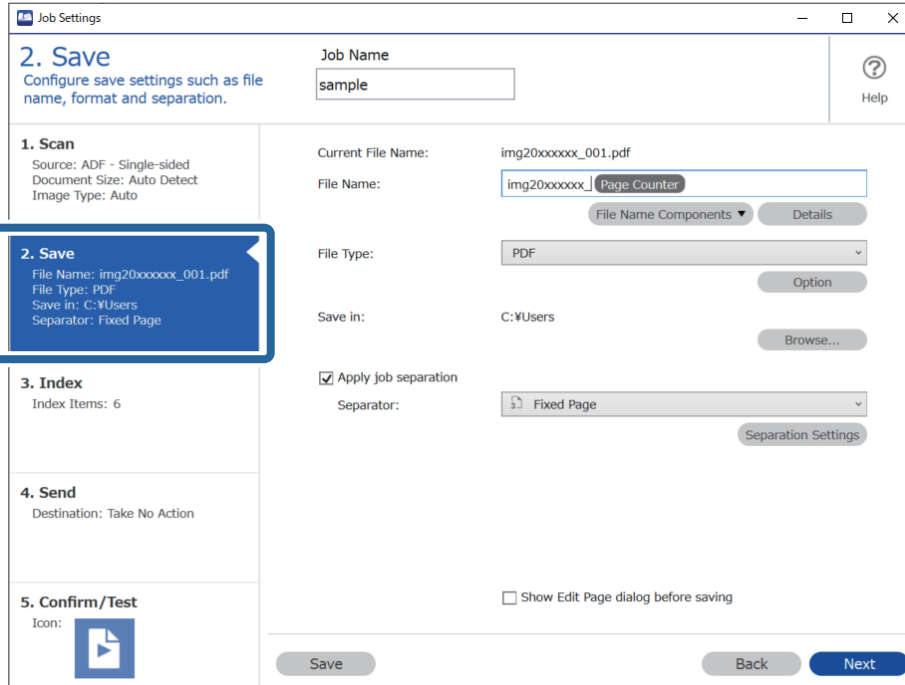

2. Select **Apply job separation**, set **Separator** to **Barcode**, and then click **Separation Settings**.

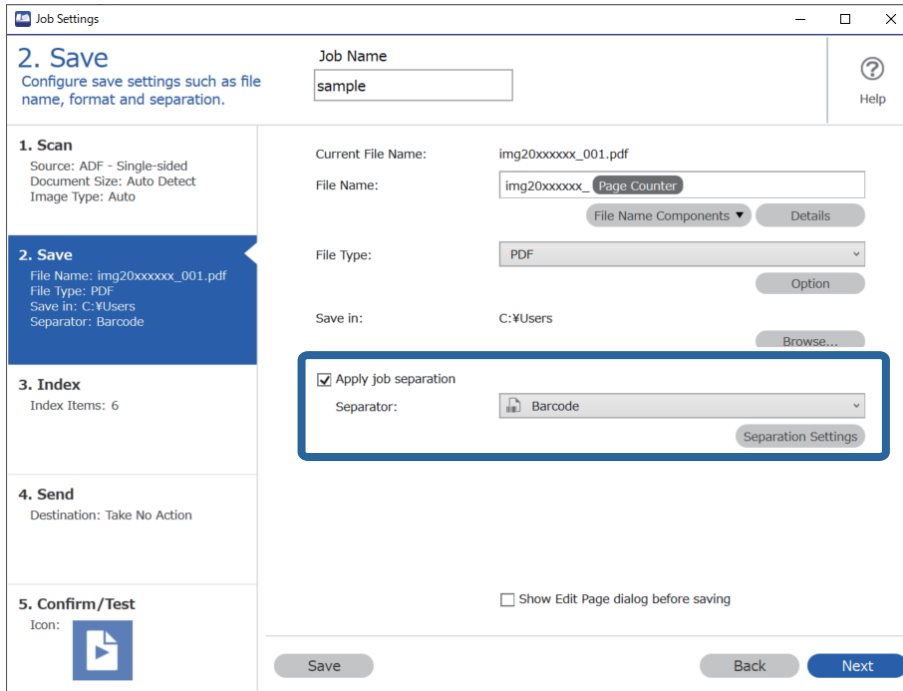

3. On the **Job Separation Settings** screen, select the type of barcode you want to use (placed in the document). Click **OK** to return to the **Job Settings** screen.

To select individual barcode types, clear **All Barcode Type**.

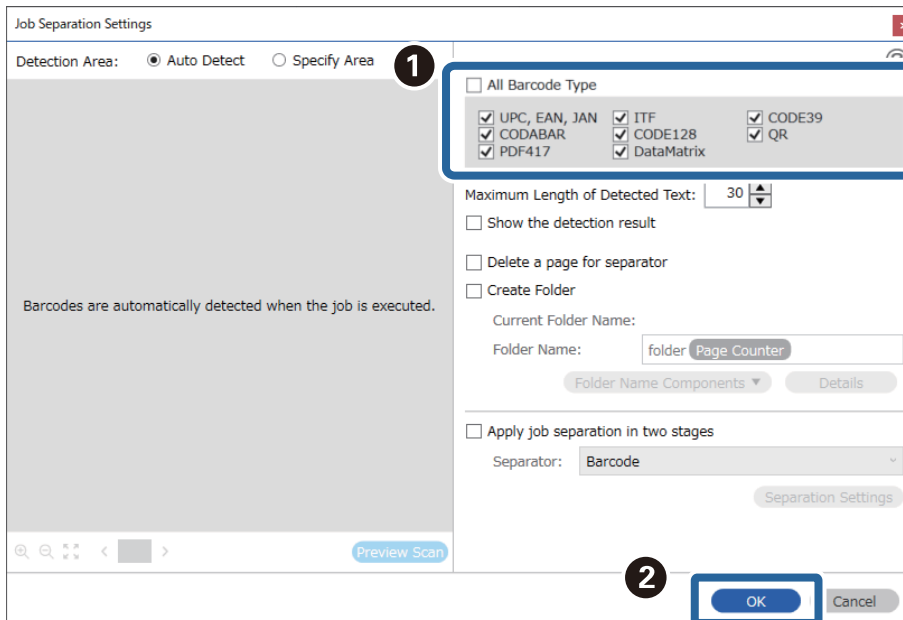

4. Click Details.

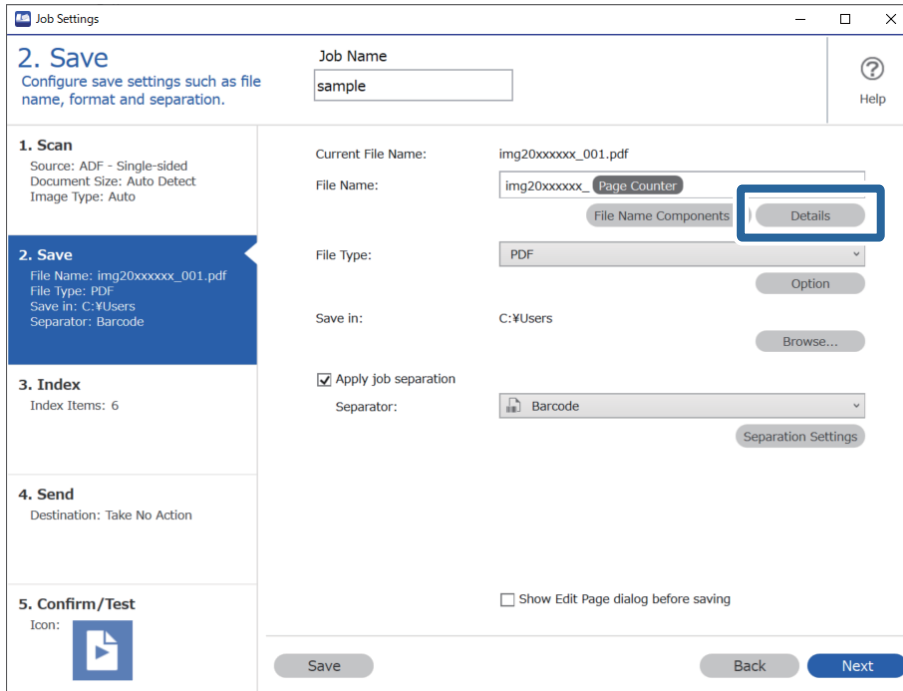

Note:

To select **Barcode** from **File Name Components**, make the setting from **Details** and then select it.

5. On the **Name Component Settings** screen, click **Barcode**, and then select the barcode type you want to use (which is on the original).

Set the same barcode as set in step 3.

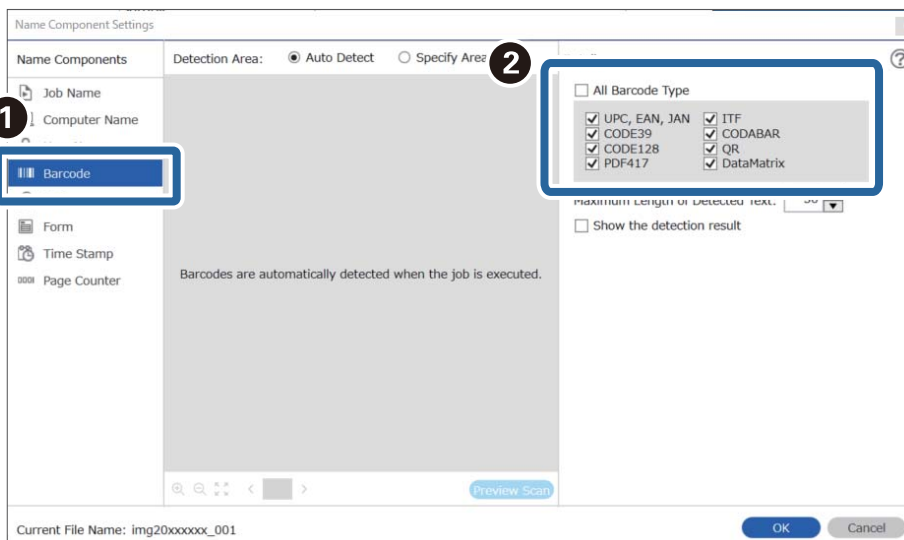

Note:

- ❑ When using a 2D barcode that has a large number of informational items, make sure you specify the maximum length of text that can be detected in **Maximum Length of Detected Text**.
- ❑ Select **Show the detection result** to check whether or not barcode text has been recognized correctly. On the screen displayed after scanning, you can check the area and text that has been recognized. You can also re-specify the area, and correct the text.

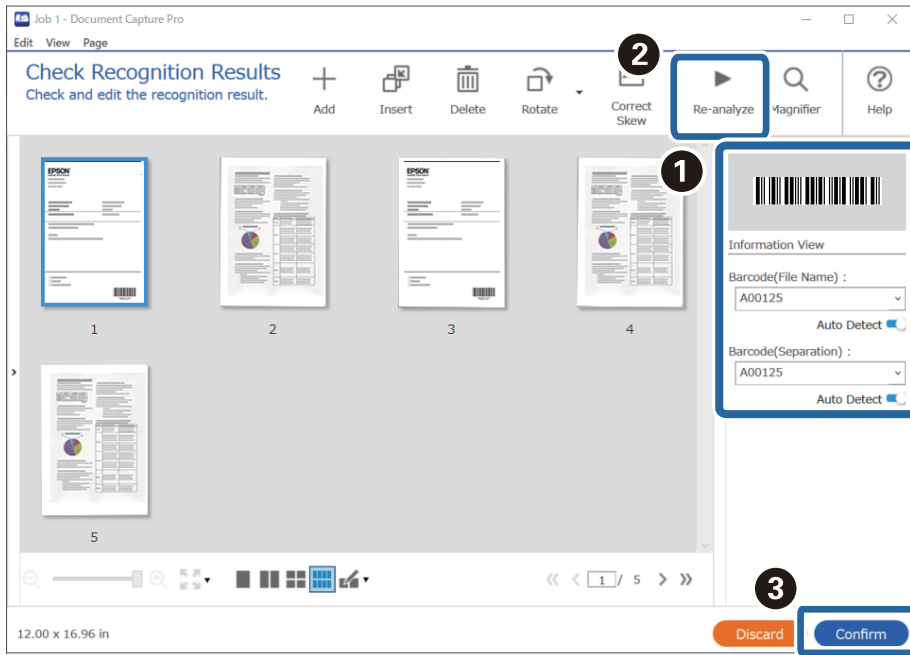

6. Select **Barcode** from **File Name Components**.

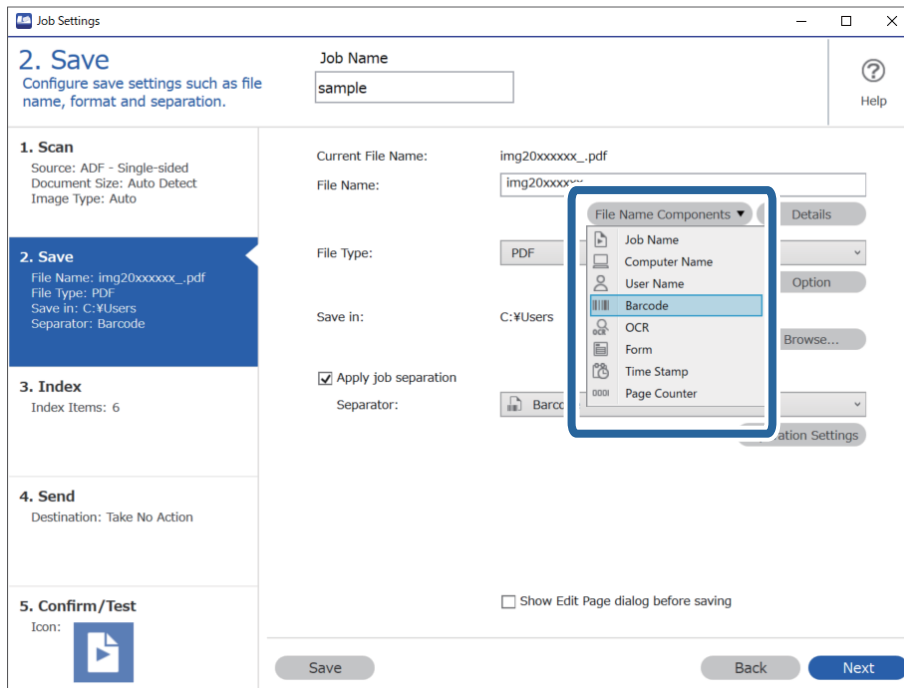

Barcode is added to **File Name**.

Note:

You can specify the point at which the **File Name Components** will be inserted with your cursor.

You can also drag and drop added items to change the order.

To delete added items, select the added item and delete it using the Delete key on your keyboard.

Creating and saving folders using OCR characters

Using OCR (a function for detecting text in scanned images and converting it to readable text), you can divide files by using the text read from a specific area, and then create and save folders using the recognized text.

This section explains the job settings for "Creating and saving folders using the text read in OCR".

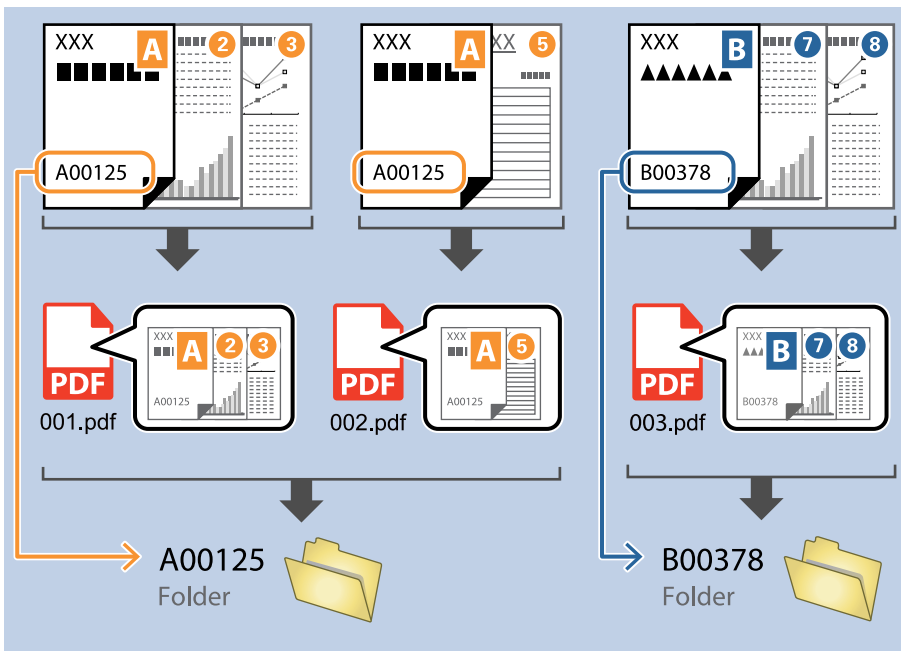

1. Display the **Job Settings** screen, and then click the **2. Save** tab.

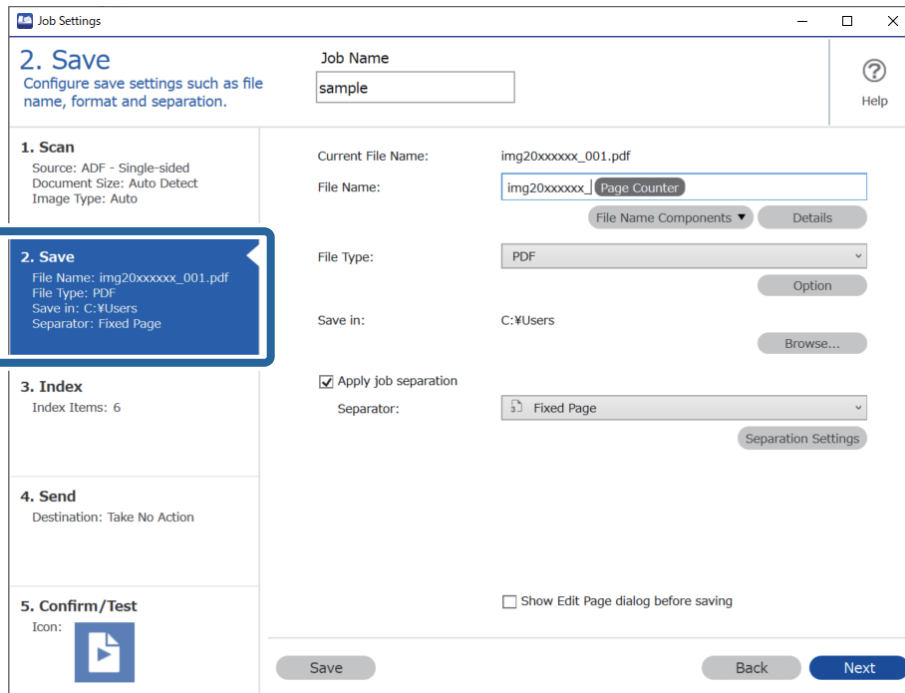

2. Select **Apply job separation**, set **Separator** to **OCR**, and then click **Separation Settings**.

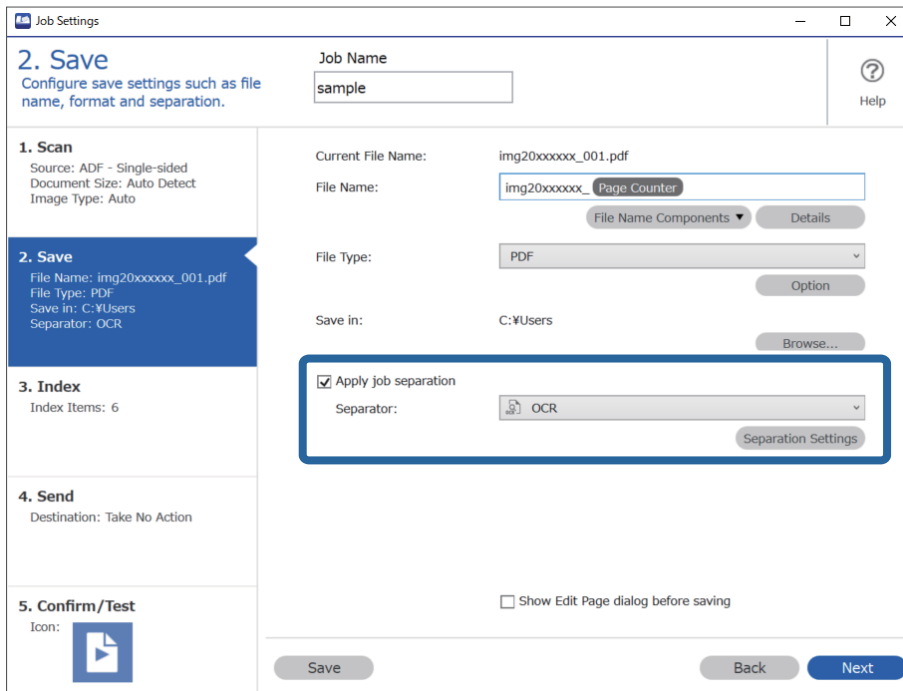

- On the **Job Separation Settings** screen, select the language of the text being read from **Recognition Text**. Select **Create Folder**, and then select **OCR** from **Folder Name Components**.

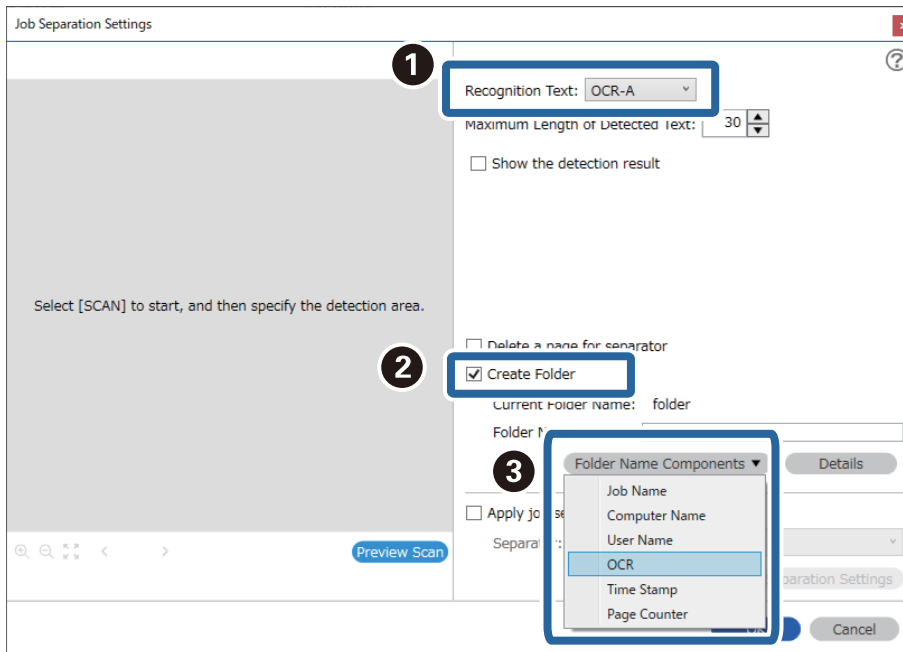

OCR is added to **Folder Name**.

Note:

You can specify the point at which the **Folder Name Components** will be inserted with your cursor.

You can also drag and drop added items to change the order.

To delete added items, select the added item and delete it using the Delete key on your keyboard.

- To set the OCR text detection area, place the document on the scanner, and then click **Preview Scan**.

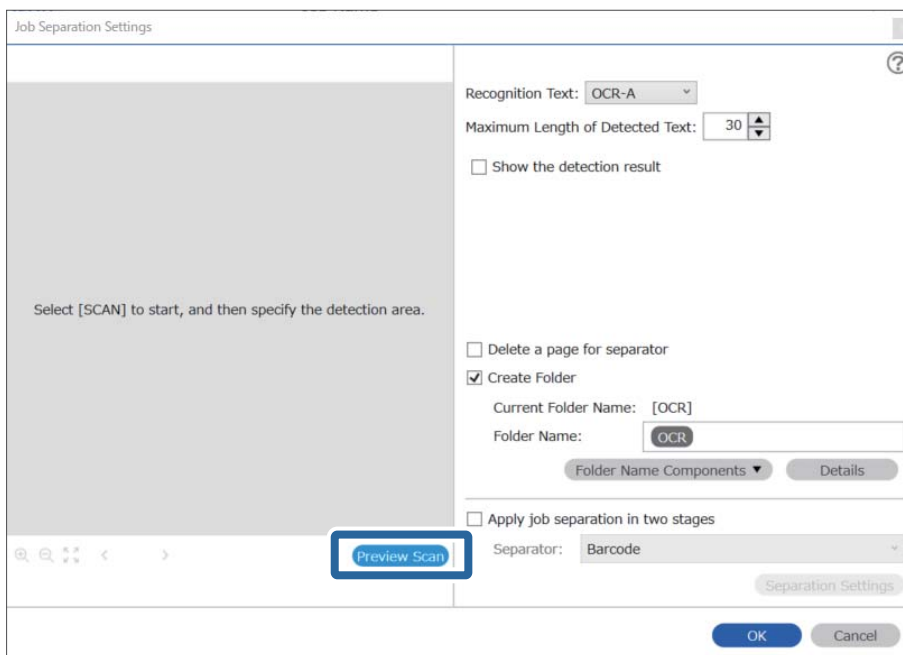

- Click OK on the Scan Settings screen.

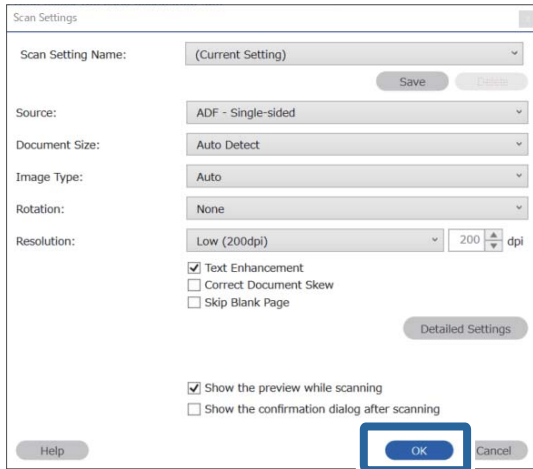

- In the scanned preview image, specify the text detection area. Click the starting point, and then drag to display a blue border to specify the text detection area.

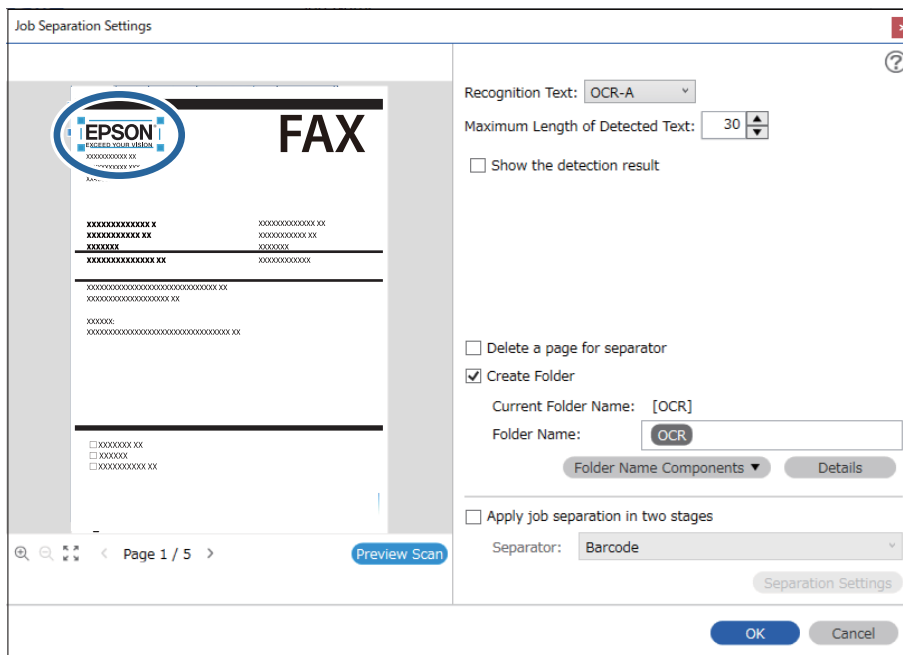

Note:

- ❑ In **Maximum Length of Detected Text**, you can specify the maximum number of characters used for the folder name from the text detected in the specified area.
- ❑ If you do not need to save the pages used for sorting, select **Delete a page for separator**. Unnecessary pages are then deleted before the data is saved.

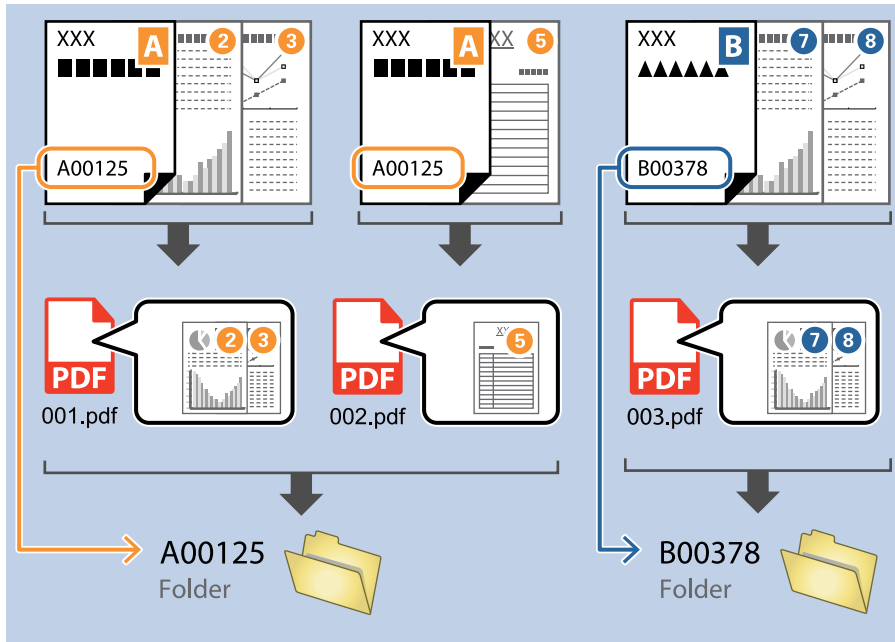

- ❑ Select **Show the detection result** to check whether or not text has been read correctly. On the screen displayed after scanning, you can check the area and text that has been recognized. You can also re-specify the area, and correct the text.

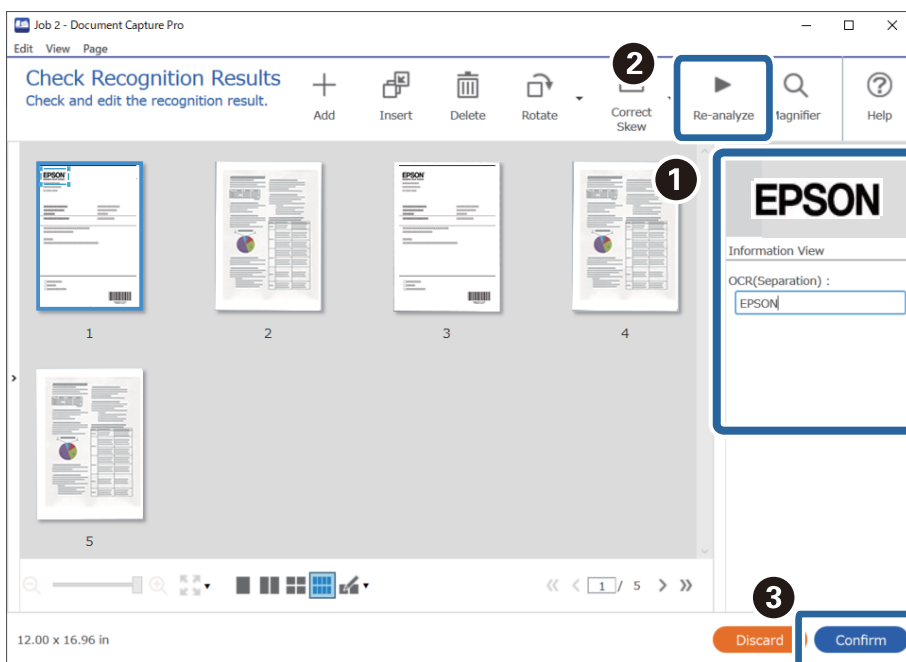

Saving files with file names using OCR characters

Using OCR (a function for detecting text in scanned images and converting it to readable text), you can read the text from the specific area, and then save files with file names using the recognized text.

This section explains the job settings for "Saving files using the text read in OCR".

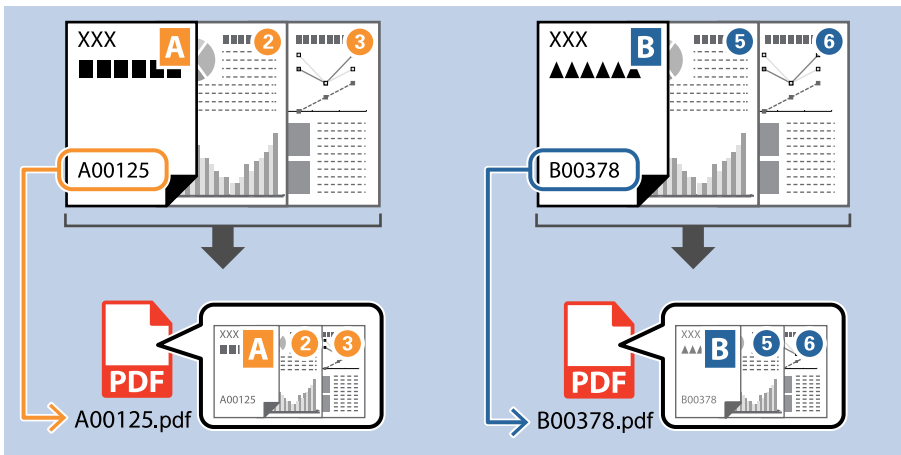

1. Display the **Job Settings** screen, and then click the **2. Save** tab.

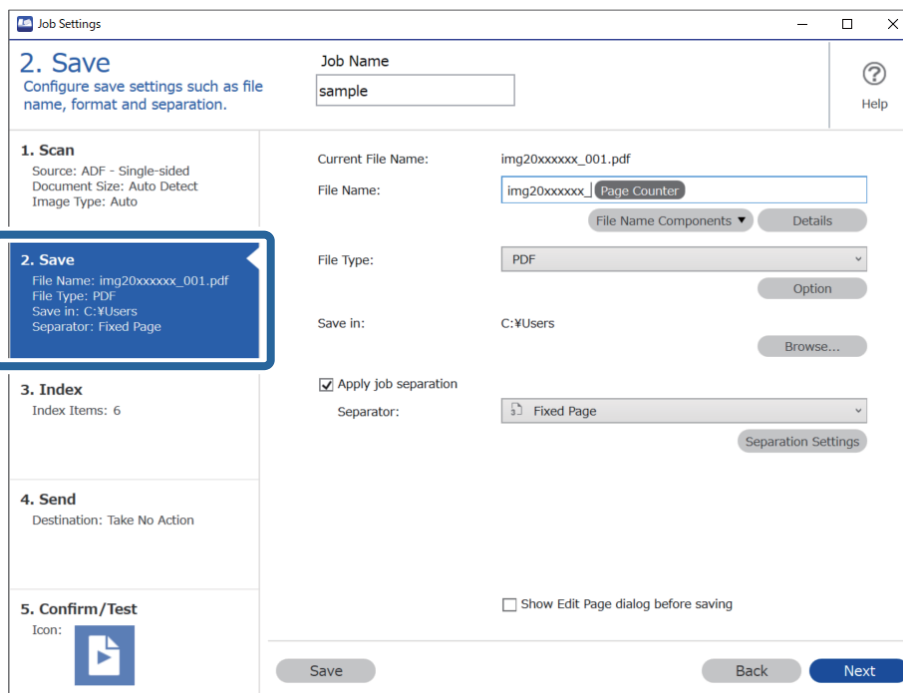

2. Select **Apply job separation**, set **Separator** to **OCR**, and then click **Separation Settings**.

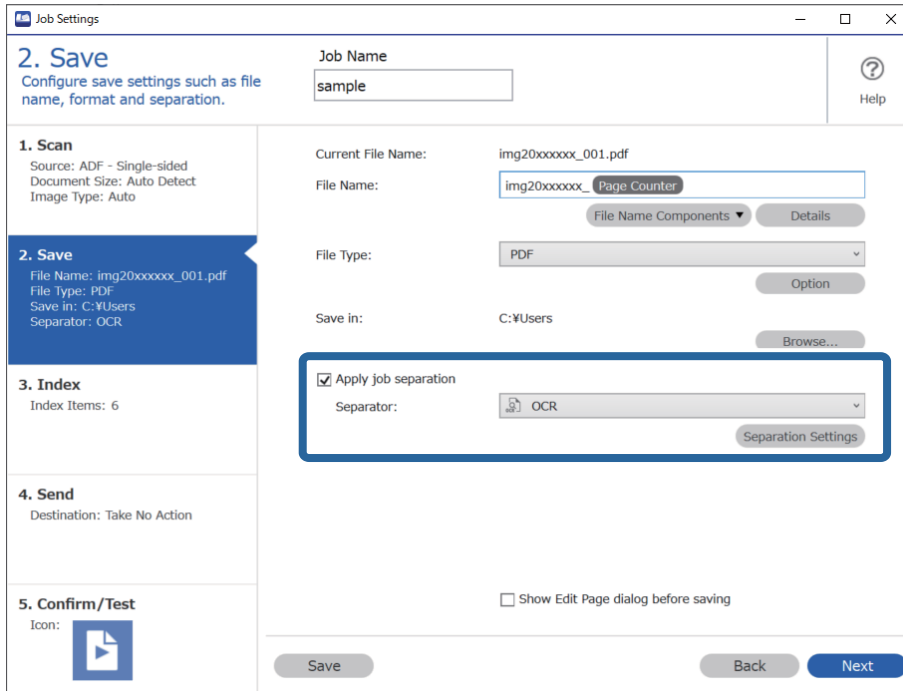

3. On the **Job Separation Settings** screen, select the language of the text being read from **Recognition Text**.

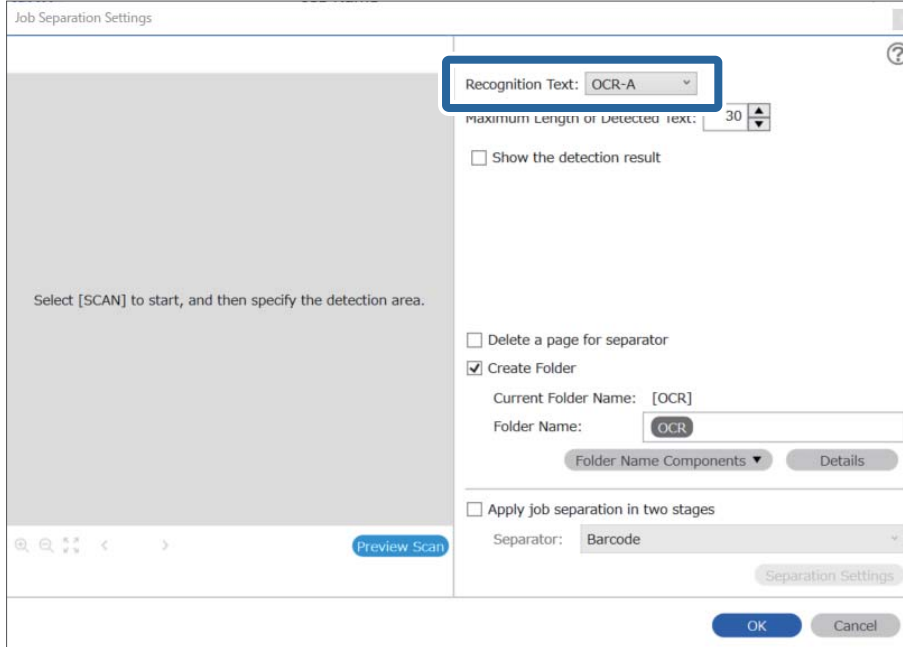

4. To set the OCR text detection area, place the document on the scanner, and then click **Preview Scan**.

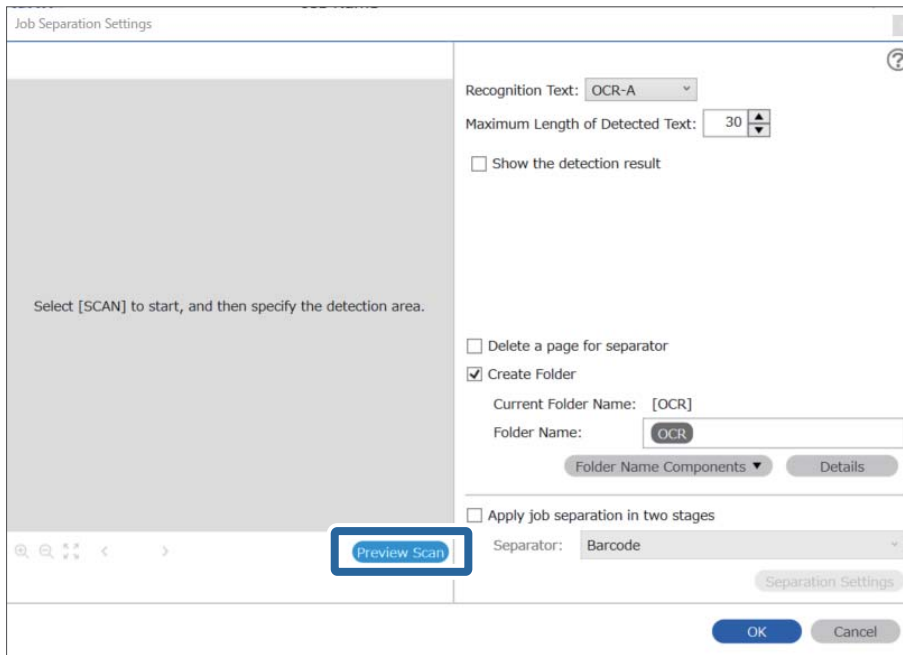

5. Click **OK** on the **Scan Settings** screen.

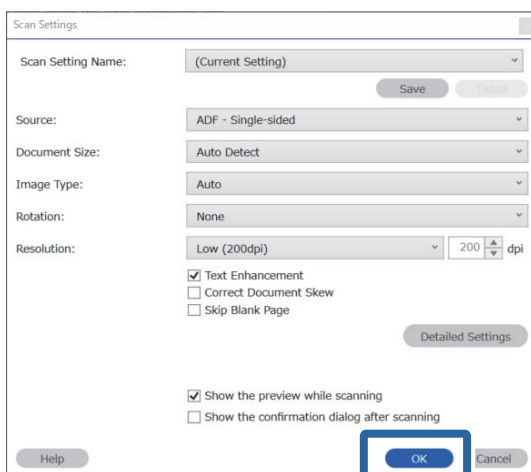

- In the scanned preview image, specify the text detection area. Click the starting point and drag to display an expanding blue border to specify the text detection area. Click **OK** to return to the **Job Settings** screen.

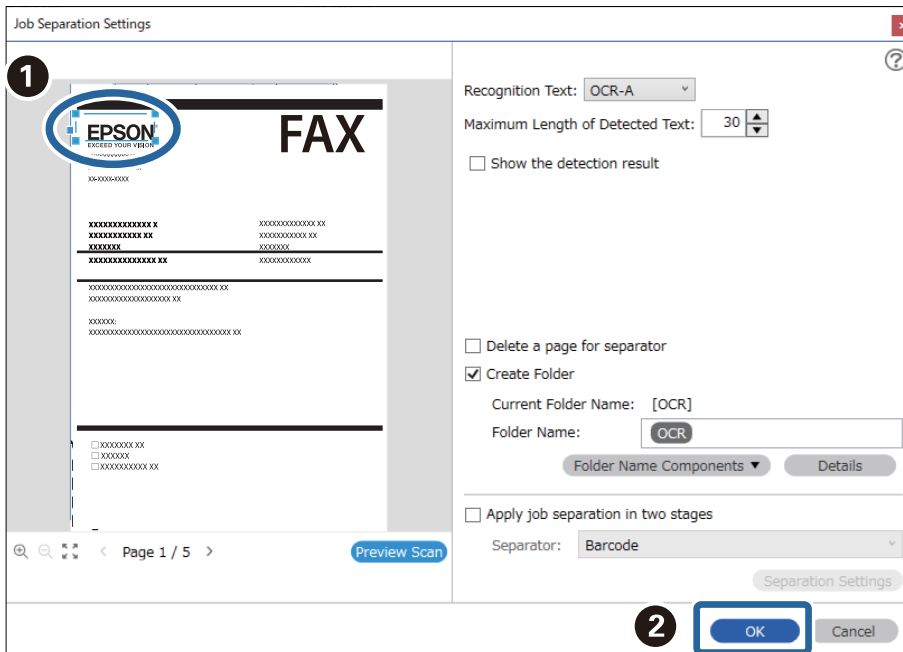

- Click **Details**.

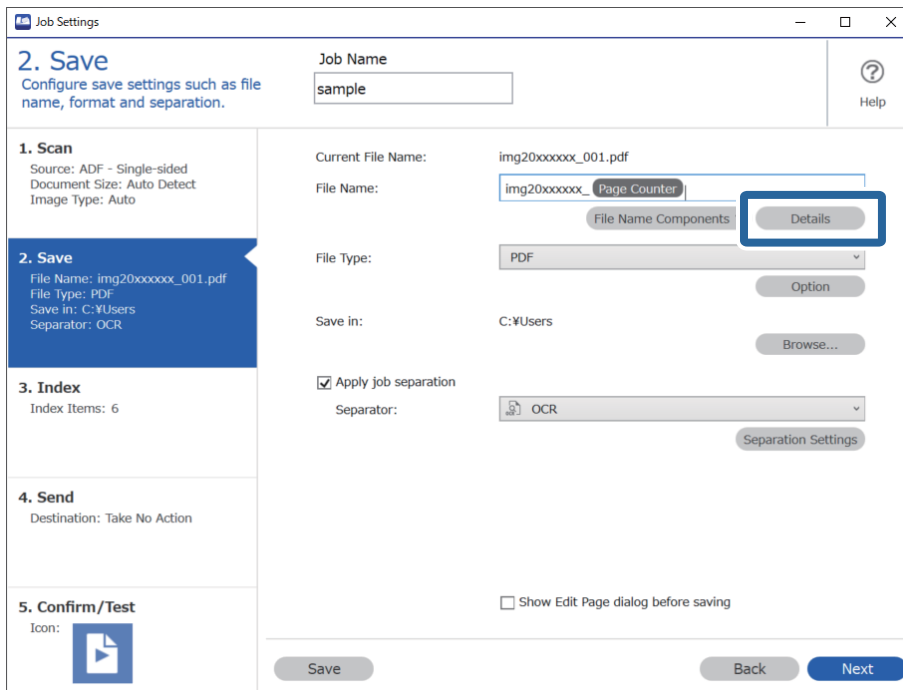

Note:

To select **OCR** from **File Name Components**, make the setting from **Details** and then select it.

8. On the **Name Component Settings** screen, click **OCR**, and then select the language of the text being read from **Recognition Text**.

Set the same language for the text as set in step 3.

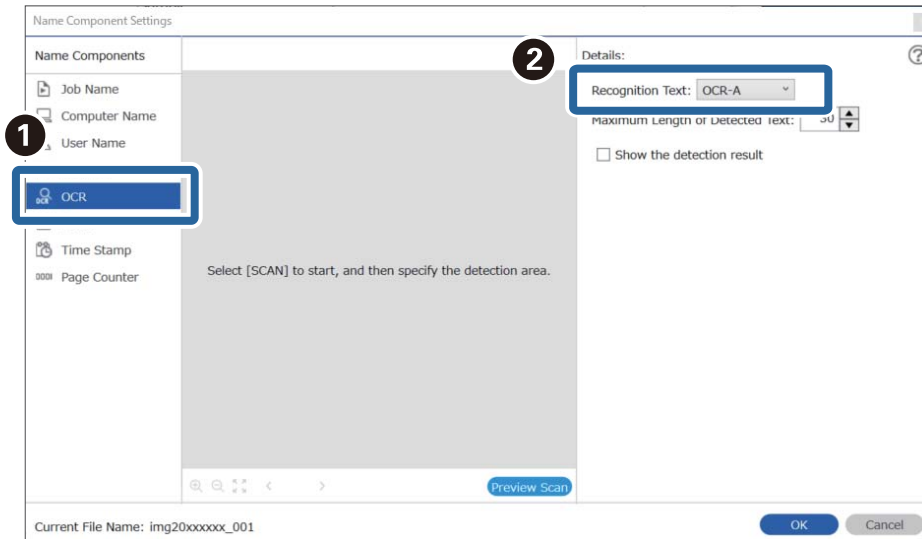

9. To set the OCR text detection area, place the document on the scanner, and then click **Preview Scan**.

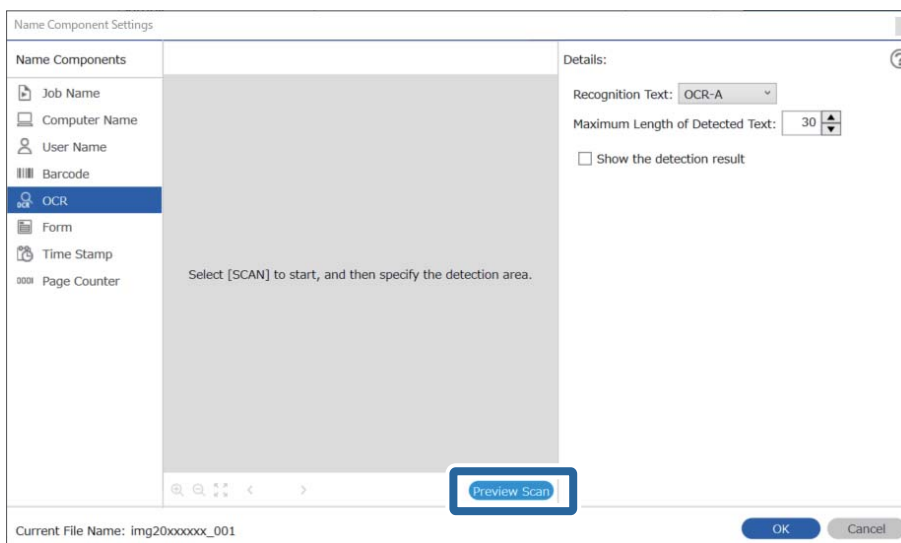

- Click OK on the Scan Settings screen.

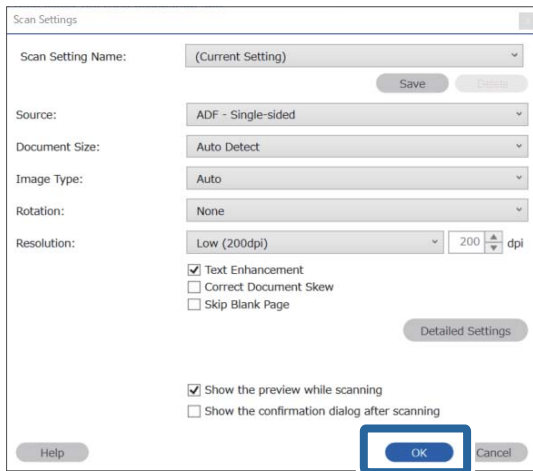

- In the scanned preview image, specify the text detection area. Click the starting point, and then drag to display a blue border to specify the text detection area. Specify the same area as set in step 5.

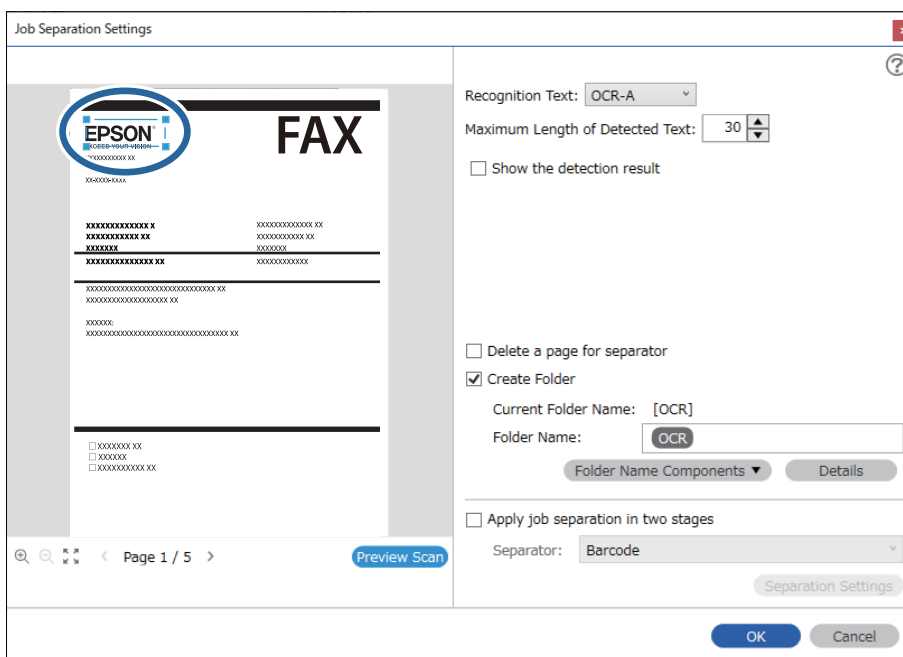

Note:

- ❑ In **Maximum Length of Detected Text**, you can specify the maximum number of characters used for the file name from the text detected in the specified area.
- ❑ Select **Show the detection result** to check whether or not text has been read correctly. On the screen displayed after scanning, you can check the area and text that has been recognized. You can also re-specify the area, and correct the text.

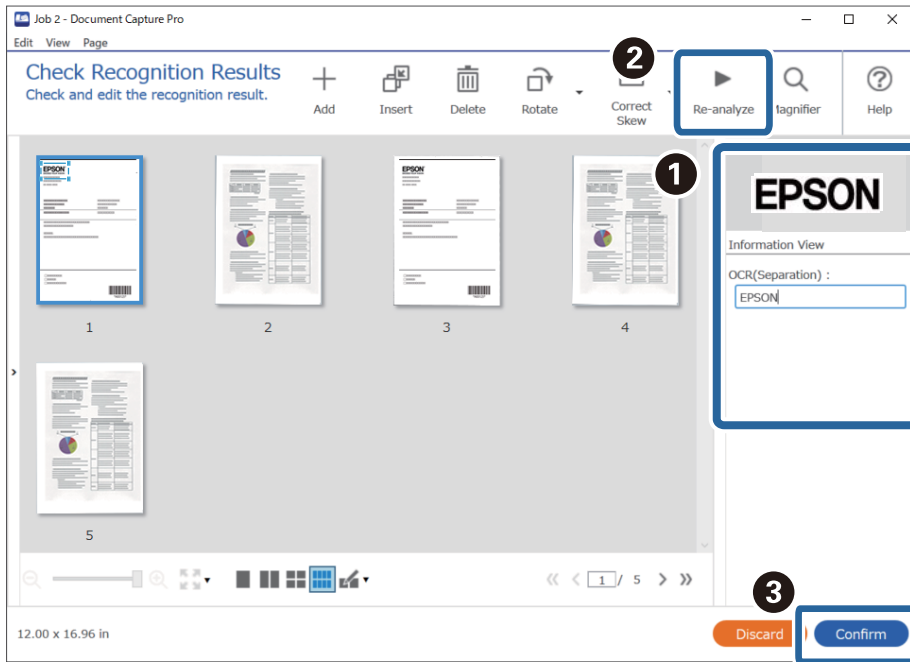

12. Select OCR from File Name Components.

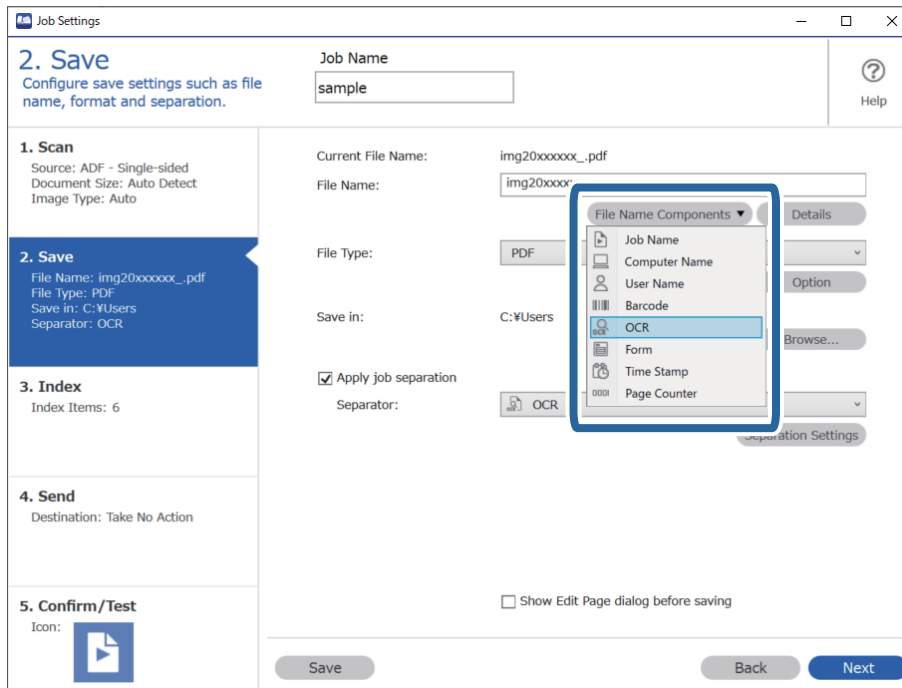

Note:

You can specify the point at which the **File Name Components** will be inserted with your cursor.

You can also drag and drop added items to change the order.

To delete added items, select the added item and delete it using the Delete key on your keyboard.

Creating and saving folders for each form

By using registered form information, you can separate scanned data by form type, and create and save folders.

This section explains the job settings for “Separating by form and saving using the form type as the folder name”.

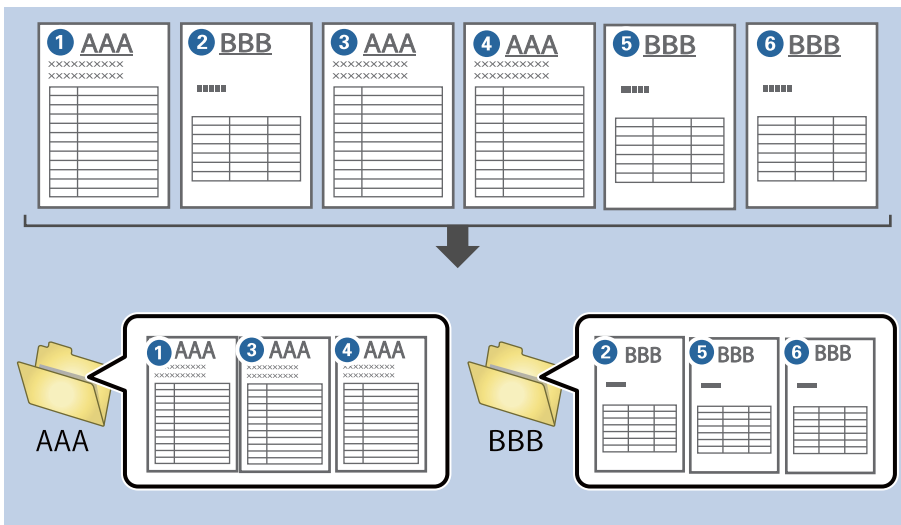

1. Display the **Job Settings** screen, and then click the **2. Save** tab.

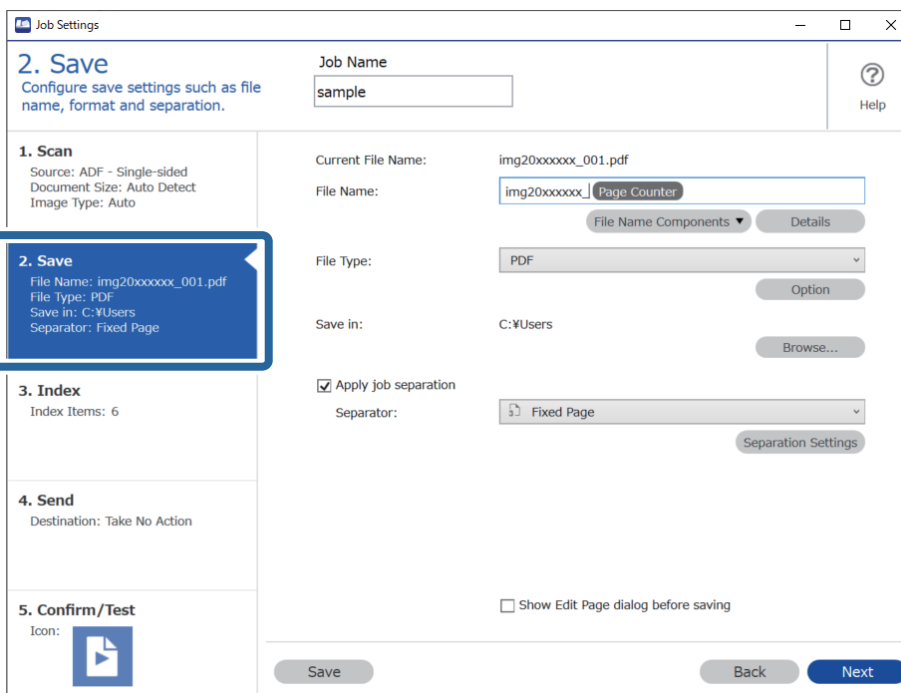

2. Select **Apply job separation**, select **Form** in **Separator**, and then click **Separation Settings**.

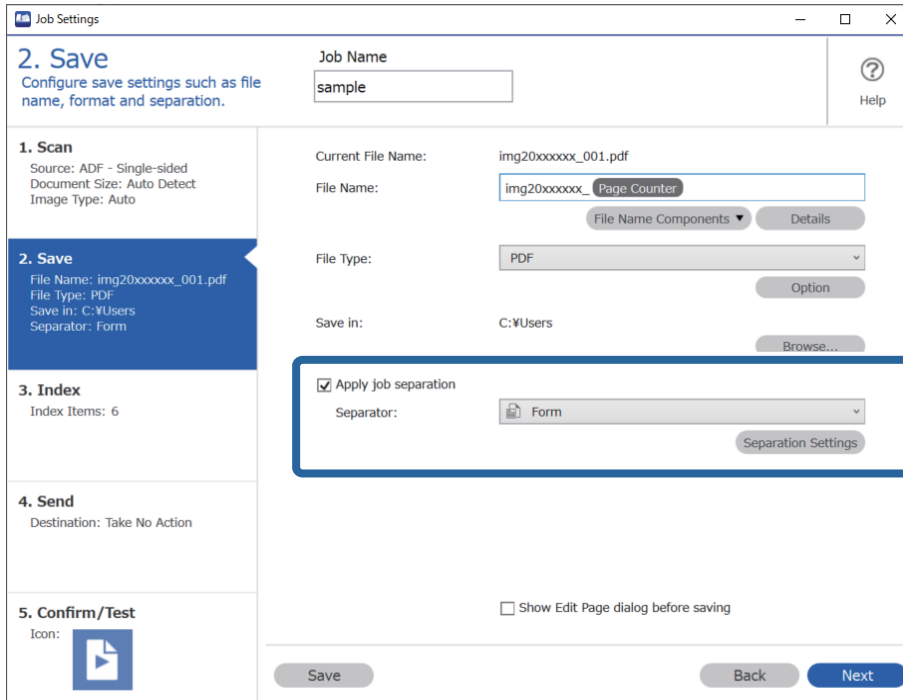

3. Click **Add** on the Job Separation Settings screen.

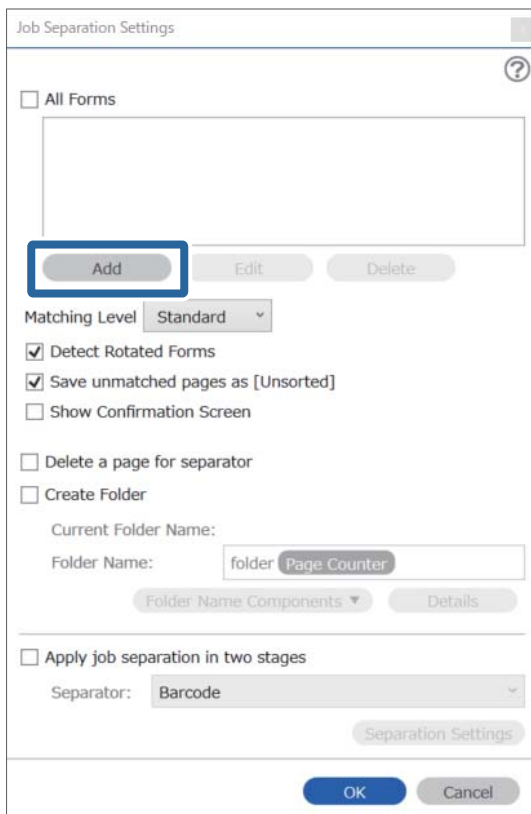

Note:

If you want to use a form for separation that has already been registered, select the form name.

To edit form information that has already been registered, select the form, and then click **Edit**.

- Place the original of the form you want to register on the scanner, and then click **Preview Scan**.

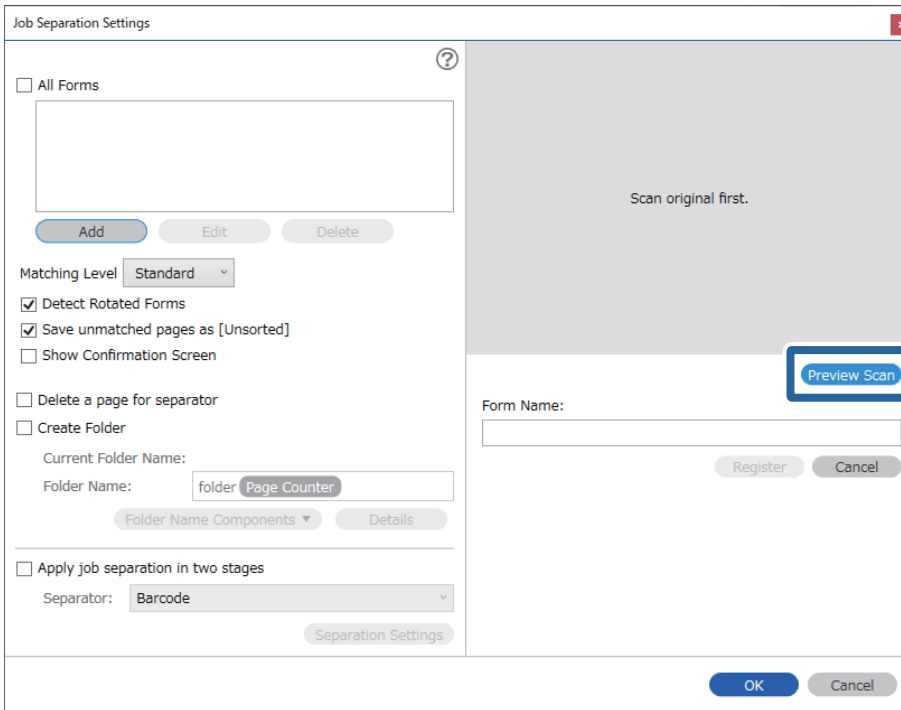

Note:

Only one page of form information is saved even if there are multiple originals.

- Make scan settings on the **Scan Settings** screen, and then click **OK**.

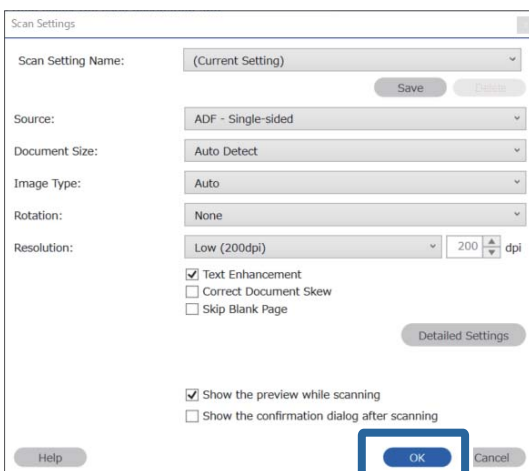

6. Enter a name for the form, and then click **Register**.

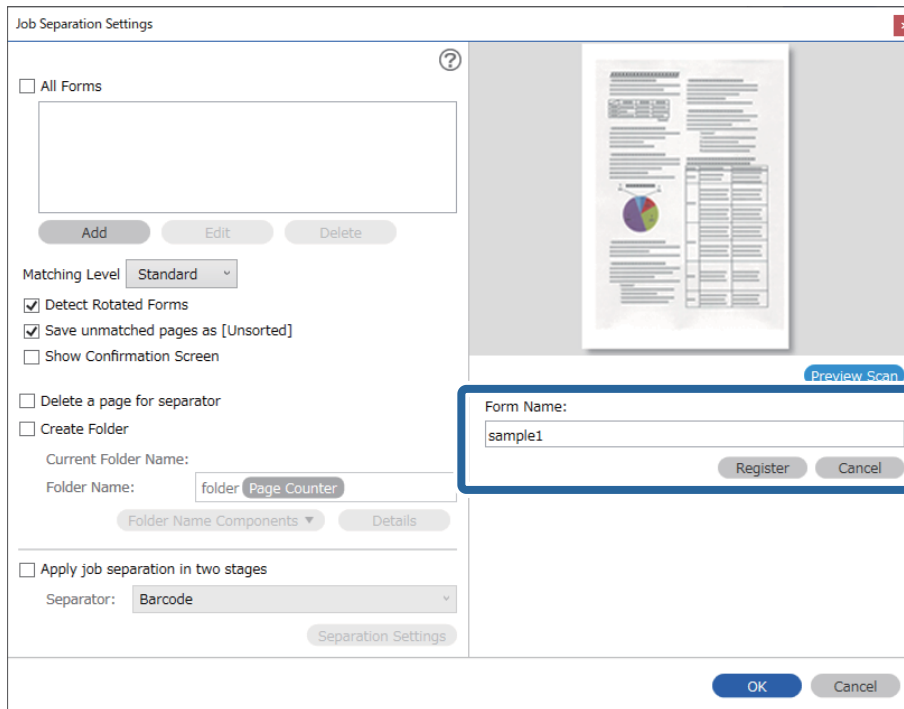

7. Repeat steps 3 to 6 to register all of the form information you want to use for separating.
8. Select **Create Folder**, and then select **Form** from **Folder Name Components**.

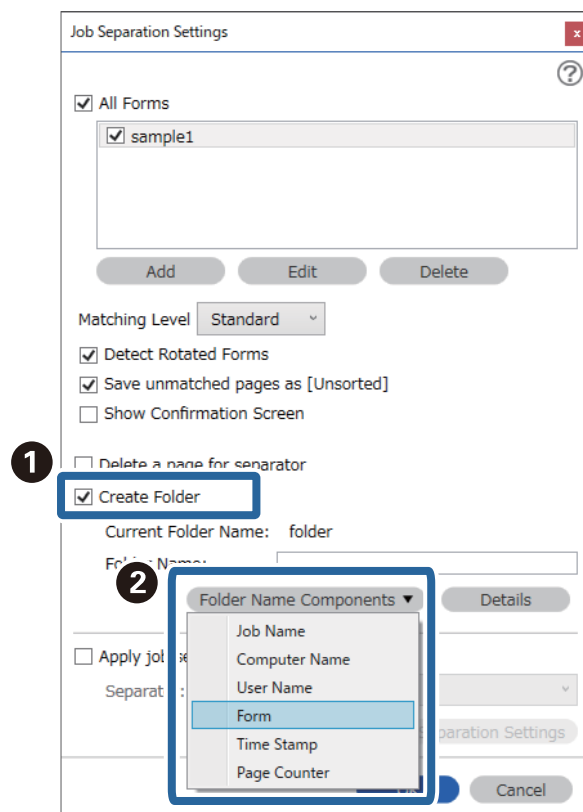

Form is added to the **Folder Name**.

Menu Options on the Control Panel

Computer.	164
Quick Send/Preset.	164
WSD.	165
Device Information.	165
Scanner Maintenance.	166
Settings.	166

Computer

You can start jobs on your computer that were created in Document Capture Pro (Windows)/Document Capture (Mac OS).

Edit Job

You can display the **Edit Job** screen by pressing the **OK** button on the **Select Job** screen. You can edit the job settings by pressing **OK** button again.

You can clear all settings you have changed by pressing the  button.

Destination

Select the destination where you want to save the scanned image.

File Type

Select the save format for the scanned image.

Image Type

Select the color of the output image.

Resolution

Select the resolution to scan.

- High:** Resolution is set to 600 dpi.
- Medium:** Resolution is set to 300 dpi.
- Low:** Resolution is set to 200 dpi.

Original Size

Select the size of the original you placed on the scanner.

Source

Select the side of the original you want to scan.

- 2-Sided:** Scans both sides of the original.
- 1-Sided:** Scans only the front side of the original.

Copies

Set the copy number when printing the scanned image using the printer.

Quick Send/Preset

You can save the scanned image to a network folder, or send the image by e-mail using pre-configured settings.

You can configure the settings for **Preset** in Web Config.

WSD

You can save the scanned image to a computer connected to the scanner, using WSD feature.

Device Information

Status

This menu is only available when the  icon is displayed on the home screen.

Indicates the following status. Press the **OK** button to see more detailed information.

- Roller Replacement Soon:** The number of scans is close to the life cycle of the rollers. Prepare replacement rollers.
[“Roller Assembly Kit Codes” on page 26](#)
- Roller Replacement:** The number of scans exceeds the life cycle of the rollers. Replace the rollers.
[“Replacing the Roller Assembly Kit” on page 177](#)
- Glass Cleaning:** Dirt has been detected on the glass surface inside the scanner. Clean the inside of the scanner. You can continue scanning by pressing the  button.
[“Cleaning Inside the Scanner” on page 172](#)
- Regular Cleaning:** It is time to clean inside the scanner.
[“Cleaning Inside the Scanner” on page 172](#)

Serial Number

Displays the serial number of the scanner.

Current Version

Displays the current firmware version.

Total Number of Scans

Displays the total number of scans.

Number of 1-Sided Scans

Displays the number of single-sided scans.

Number of 2-Sided Scans

Displays the number of double-sided scans.

Number of Scans of Carrier Sheet

Displays the number of scans using a Carrier Sheet.

Number of Scans After Replacing Roller

Displays the number of scans after replacing the roller assembly kit.

Press the **OK** button to reset the number after replacing the roller assembly kit.

Number of Scans After Regular Cleaning

Displays the number of scans after performing regular cleaning.

Press the **OK** button to reset the number after performing regular cleaning.

Scanner Maintenance

Roller Cleaning

Displays how to clean the roller inside the scanner.

Roller Replacement

Displays how to replace the roller assembly kit. You can also reset the number after replacing the roller assembly kit.

Regular Cleaning

Displays how to perform regular cleaning of the inside of the scanner. You can also reset the number after performing regular cleaning.

Glass Cleaning

Displays how to perform cleaning for the scanner glass inside the scanner.

Settings

Basic Settings

LCD Brightness

Adjust the brightness of the LCD screen.

Sleep Timer

Adjust the time period for entering sleep mode (energy saving mode) when the scanner has not performed any operations. The LCD screen turns black when the set time has passed.

Power Off Settings

Your product may have this feature or the **Power Off Timer** feature depending on the location of purchase.

Power Off If Inactive

Select this setting to turn the scanner off automatically if it is not used for a specified period of time. Any increase will affect the product's energy efficiency. Please consider the environment before making any change.

Power Off If Disconnected

Select this setting to turn the scanner off after 30 minutes when all ports including the USB port are disconnected. This feature may not be available depending on your region.

Date/Time Settings

- Date/Time:** Enter the current date and time.
- Daylight Saving Time:** Select the summer time setting that applies to your area.
- Time Difference:** Enter the time difference between your local time and UTC (Coordinated Universal Time).

Keyboard

Change the layout of the keyboard on the LCD screen.

Language

Select the country or region in which you are using your scanner.

Start-up Screen

Specify the initial menu displayed on the LCD screen when the scanner turns on and **Operation Time Out** is enable.

Operation Time Out:

Select **On** to return to the initial screen when no operations have been performed for the specified time. When user restrictions have been applied and no operations are performed for the specified time, you are logged out and returned to the initial screen.

PC Connection via USB:

Select **Enable** to allow a computer to access the scanner when connected by USB. When **Disable** is selected, scanning that is not sent over a network connection is restricted.

Direct power on

Turn on the scanner directly when the scanner is connected to the power source, without pressing the power button.

Scanner Settings

Slow

Slows down the feeding speed whenever scanning. When set to **On**, the icon turns blue (.

Enable this in the following situations:

- When originals jam frequently
- When loading thin originals
- When scanning different types or sizes of originals at once
- If you feel that the scanner is noisy

DFDS Function

Skips double feed detection once and continues scanning. When set to **On**, the icon turns blue (.

Enable this to scan originals that are detected as double feeds, for example plastic cards or envelopes.

Double Feed Stop Timing

Set the operation when any double feed is detected.

- Immediate: Stops feeding immediately after any double feed is detected.
- After Eject: Originals detected as double feed are scanned as is, and the subsequent feed of originals is temporarily stopped.

If the scanned image has no problem, you can resume scanning as is.

Paper Protection

Reduces damage to the originals by stopping scanning immediately when the following status is detected.

- A feeding error for the originals occurs
- Originals are fed askew

Select the detection level to enable this feature. See the table below for details on each level.

Level	Description
On-Low	Lower the sensitivity to detect the skew of the originals.
On-Medium	Detect the skew of the stapled originals and the skew that On-Low could not detect.
On-High	Increase the sensitivity to detect the skew of the originals.

Important:

- This function does not always prevent damage of originals.
- Depending on the condition of the originals being fed, feeding errors cannot be detected.

Note:

Depending on the original, the condition of feeding, or the level you set, this feature may not work correctly.

- Select **Off** to disable the feature when scanning plastic cards or thick paper.
- When misdetection occurs frequently, lower the level of this feature.
- Some originals may be misdetected as feeding errors, such as irregular shaped originals or originals scanned askew.
- When loading multiple originals, make sure to align the leading edge of the originals. Originals may be misdetected as feeding errors if the edges of the originals are not aligned, even if they are scanned correctly.
- To scan the originals without skewing, adjust the edge guides to fit the originals before scanning.

Detect Glass Dirt

Detects dirt on the glass surface inside the scanner. You can select the level of the detection.

Depending on the dirt, this feature may not work correctly.

Ultrasonic Double Feed Detection

Detects a double feed error when multiple originals are fed and stops scanning.

Depending on the original, such as envelopes, plastic cards, originals with labels or stickers, and so on, this feature may not work correctly.

Use if you cannot set double feed detection from external software.

Automatic Feeding Mode Timeout

Set the timeout when using Automatic Feeding Mode.

This setting is available when you scan from "Quick Send" or "Preset".

Document Capture Pro

Before scanning using the **Computer** menu on the control panel, set the operation mode on the control panel to match the computer on which Document Capture Pro is installed.

Client Mode

Select this if Document Capture Pro is installed on Windows or Mac OS.

Server Mode

Select this if Document Capture Pro is installed on a Windows Server. Next, enter the server address.

System Administration

Admin Settings

Check the administrator settings from Web Config. Access Web Config and select the **Product Security** tab or **Device Management** tab.

Password Encryption

Encrypt your password.

If you turn the power off while restart is in progress, data may be damaged and the scanner settings are restored to defaults. In that case, set password information again.

You can check this from Web Config. Access Web Config and select the **Product Security** tab > **Password Encryption**.

Customer Research

Select **Approve** to provide product usage information such as the number of scans to Seiko Epson Corporation.

Restore Default Settings

- Network Settings: Restore network related settings to their initial status.
- All except Network: Restore other settings to their initial status except for network related settings.
- All Settings: Restore all settings to their initial status when purchased.

WSD Settings

Enable or disable the WSD (Web Service for Devices) feature.

You can check this from Web Config. Access Web Config and select the **Network Security** tab > **Protocol** > **WSD Settings**.

Roller Replacement Alert Setting

Count Alert Setting

Changes the scanning number when the roller replacement notification will be displayed.

Regular Cleaning Alert Settings

Warning Alert Setting

Notifies you when it is time to clean the inside the scanner.

Count Alert Setting

Changes the scanning number when the cleaning notification will be displayed.

Network Status

Displays the current network settings for the following items.

- Connection
- Device Name
- IP Address
- Subnet Mask
- Default Gateway
- MAC Address

Maintenance

Cleaning Outside the Scanner.	172
Cleaning Inside the Scanner.	172
Replacing the Roller Assembly Kit.	177
Resetting the Number of Scans.	181
Energy Saving.	182
Transporting the Scanner.	182
Updating Applications and Firmware.	183

Cleaning Outside the Scanner

Wipe off any stains on the outer case with a dry cloth or a cloth dampened with mild detergent and water.

 **Important:**

- Never use alcohol, thinner, or any corrosive solvent to clean the scanner. Deformation or discoloration may occur.
- Do not let water get inside the product. This could cause a malfunction to occur.
- Never open the scanner case.

1. Press the  button to turn off the scanner.
2. Unplug the AC adapter from the scanner.
3. Clean the outer case with a cloth dampened with mild detergent and water.

Note:

Wipe the LCD screen by using a soft, dry cloth.

Cleaning Inside the Scanner

After using the scanner for a while, paper and room dust on the roller or the glass part inside the scanner may cause paper feed or scanned image quality problems. Clean the inside of the scanner every 5,000 scans. You can check the latest number of scans on the control panel or in the Epson Scan 2 Utility.

If a surface is stained with a hard-to-remove material, use a genuine Epson cleaning kit to remove the stains. Use a small amount of cleaner on the cleaning cloth to remove the stains.

 **Important:**

- Never use alcohol, thinner, or any corrosive solvent to clean the scanner. Deformation or discoloration may occur.
- Never spray any liquid or lubricant on the scanner. Damage to equipment or circuits may cause abnormal operations.
- Never open the scanner case.

1. Press the  button to turn off the scanner.
2. Unplug the AC adapter from the scanner.

3. Pull the lever and open the scanner cover.

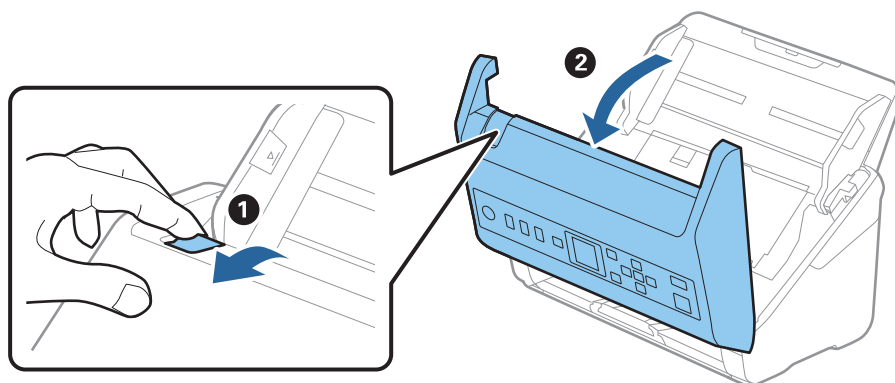

4. Wipe off any stains on the plastic roller and glass surface at the bottom inside of the scanner cover using a soft cloth or a genuine Epson cleaning kit.

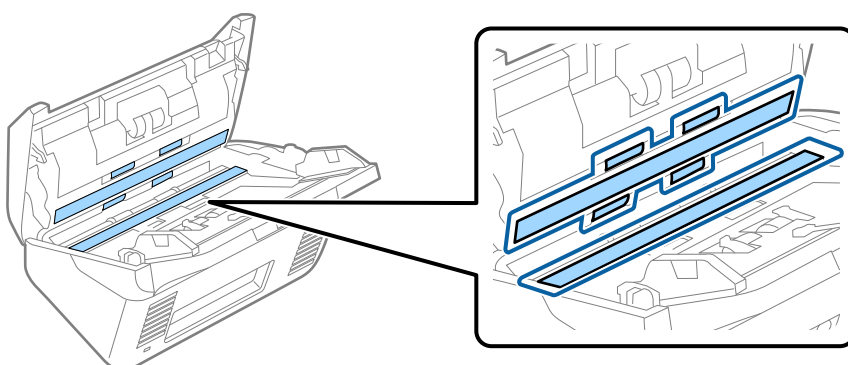

! **Important:**

- ❑ Do not place too much force on the glass surface.
- ❑ Do not use a brush or a hard tool. Any scratches on the glass may affect the scan quality.
- ❑ Do not spray cleaner directly onto the glass surface.

5. Wipe off any stains on the sensors with a cotton swab.

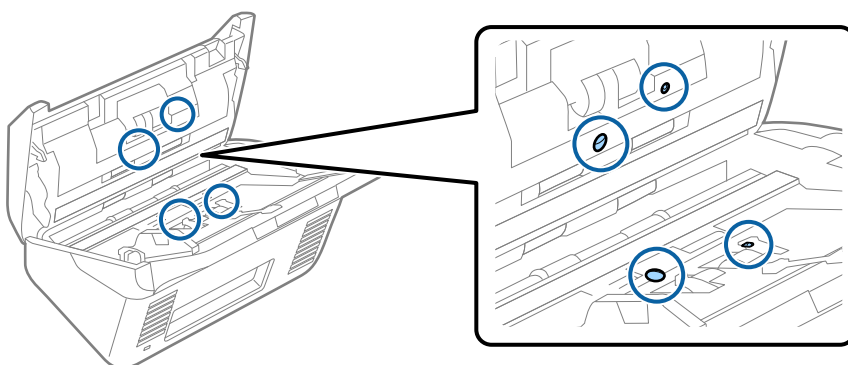



Important:

Do not use liquid such as a cleaner on a cotton swab.

6. Open the cover, and then remove the separation roller.
See “Replacing the Roller Assembly Kit” for more details.

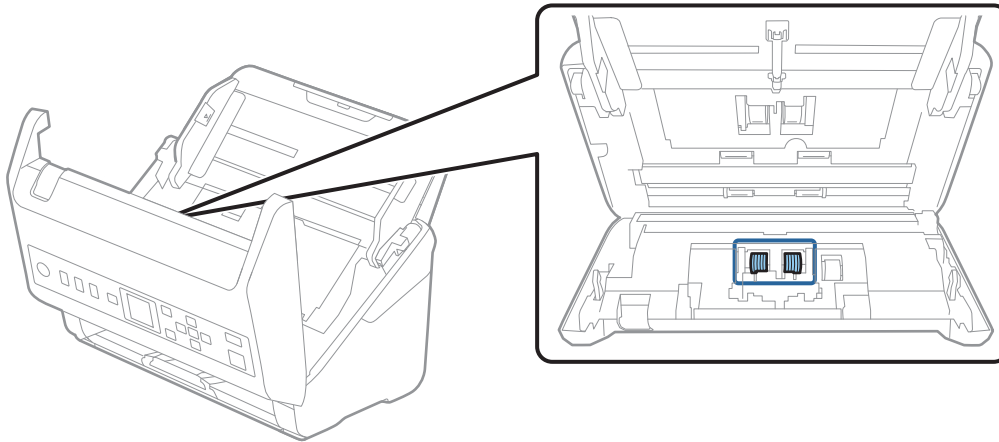

7. Wipe off any dust or dirt on the separation roller using a genuine Epson cleaning kit or a soft, moist cloth.

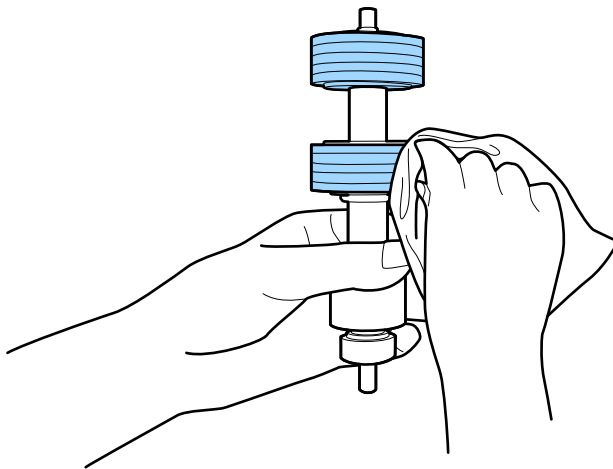

Important:

Use only a genuine Epson cleaning kit or a soft, moist cloth to clean the roller. Using a dry cloth may damage the surface of the roller.

8. Open the cover, and then remove the pickup roller.
See “Replacing the Roller Assembly Kit” for more details.

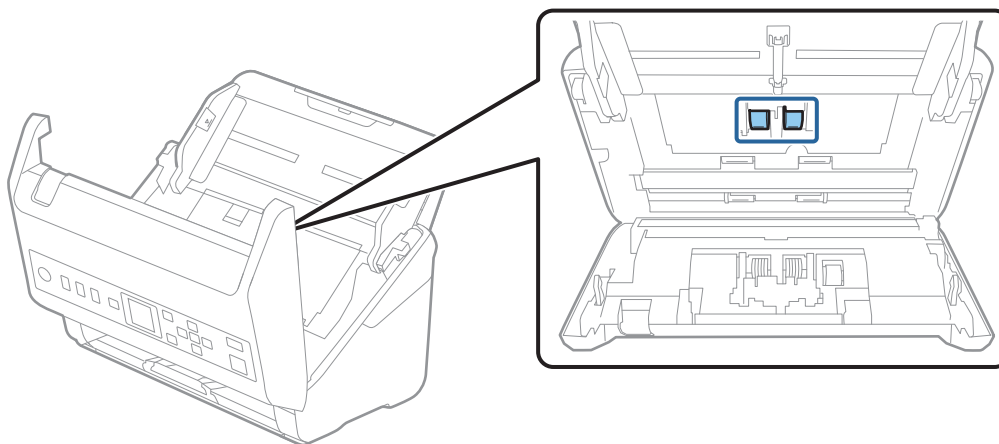

9. Wipe off any dust or dirt on the pickup roller using a genuine Epson cleaning kit or a soft, moist cloth.

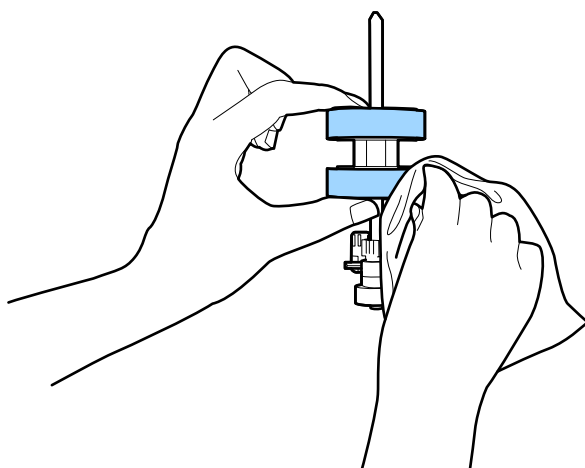

! **Important:**

Use only a genuine Epson cleaning kit or a soft, moist cloth to clean the roller. Using a dry cloth may damage the surface of the roller.

10. Close the scanner cover.
11. Plug in the AC adapter, and then turn on the scanner.
12. Select **Scanner Maintenance** from the home screen using the ◀ or ▶ button, and then press the **OK** button.
13. On the **Scanner Maintenance** screen, select **Roller Cleaning** using the ◀ or ▶ button, and then press the **OK** button.
14. Pull the lever to open the scanner cover.
The scanner enters roller cleaning mode.

15. Slowly rotate the rollers at the bottom by pressing  button. Wipe the surface of the rollers using a genuine Epson cleaning kit or a soft cloth dampened with water. Repeat this until the rollers are clean.

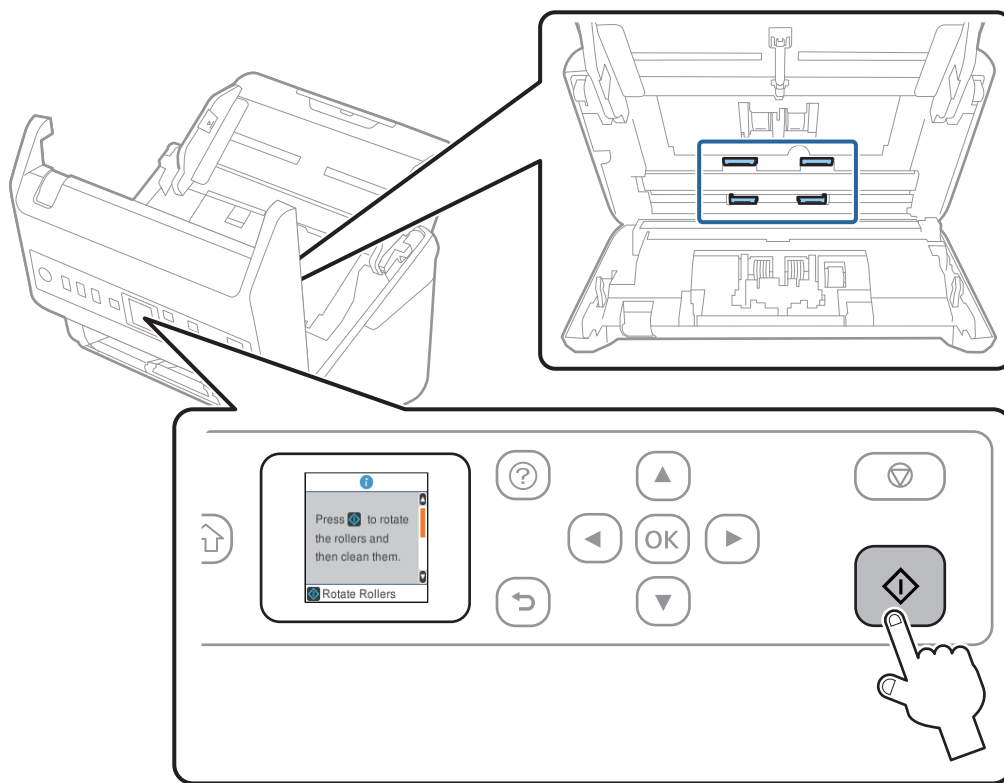

 **Caution:**

Be careful not to get your hands or hair caught in the mechanism when operating the roller. This could cause an injury.

16. Close the scanner cover.
The scanner exits roller cleaning mode.

Related Information

- ➔ [“Cleaning Kit Codes” on page 26](#)
- ➔ [“Replacing the Roller Assembly Kit” on page 177](#)

Replacing the Roller Assembly Kit

The roller assembly kit (the pickup roller and the separation roller) needs to be replaced when the number of scans exceeds the life cycle of the rollers. When a replacement message is displayed on the control panel or your computer screen, follow the steps below to replace it.

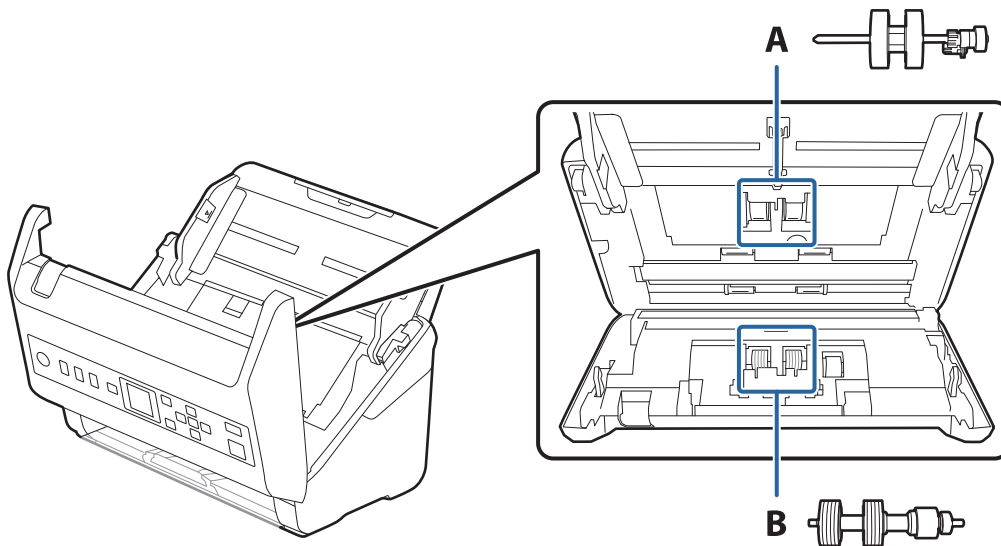

A: pickup roller, B: separation roller

1. Press the  button to turn off the scanner.
2. Unplug the AC adapter from the scanner.
3. Pull the lever and open the scanner cover.

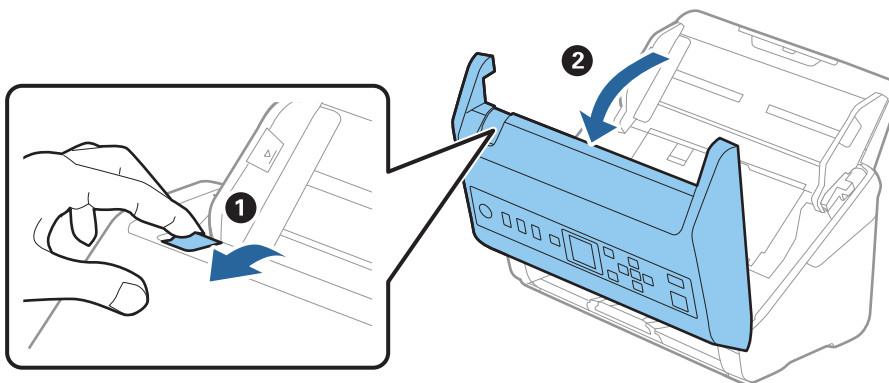

4. Open the cover of the pickup roller, and then slide and remove it.

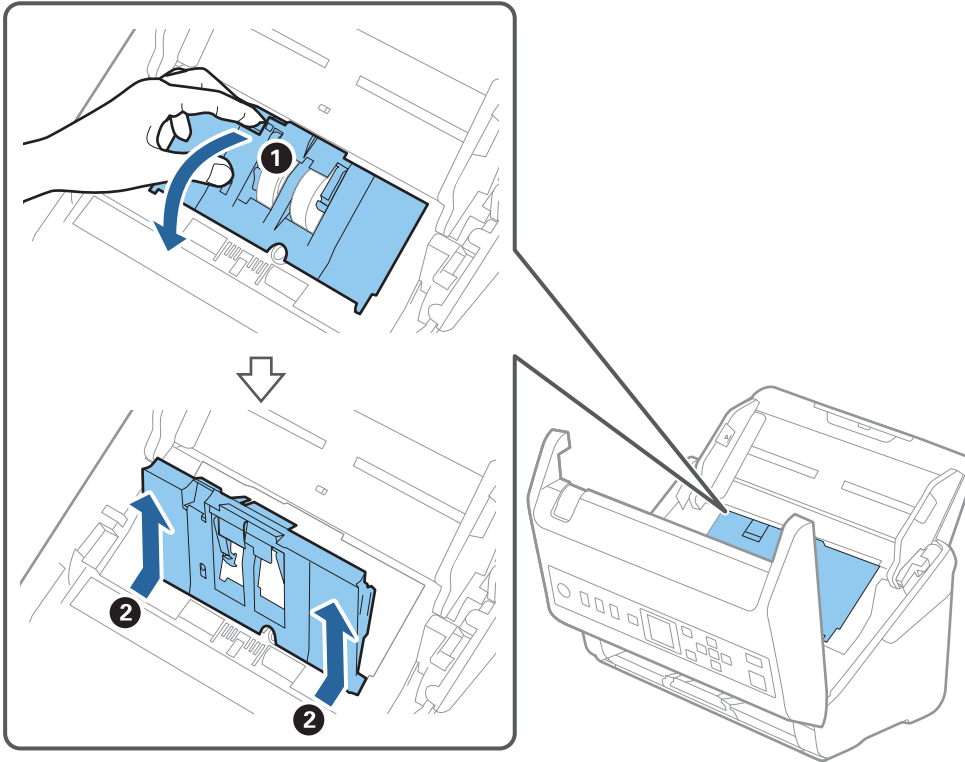

5. Pull down the fixture of the roller axis, and then slide and remove the installed pickup rollers.

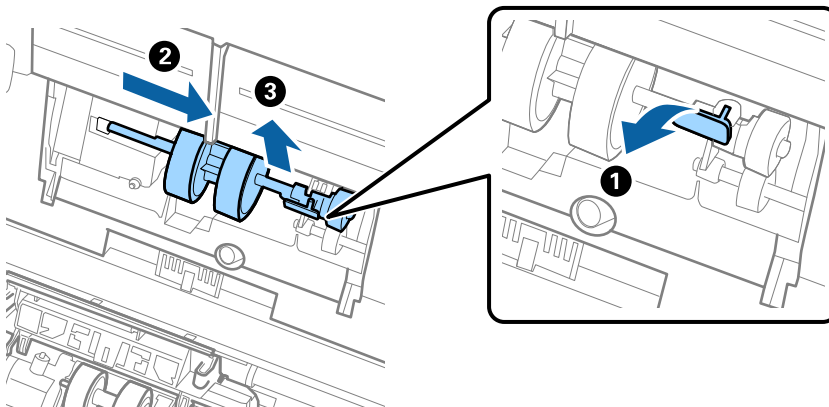

! **Important:**

Do not pull out the pickup roller forcibly. This could damage the inside of the scanner.

6. While holding down the fixture, slide the new pickup roller to the left and insert it into the hole in the scanner. Press the fixture to secure it.

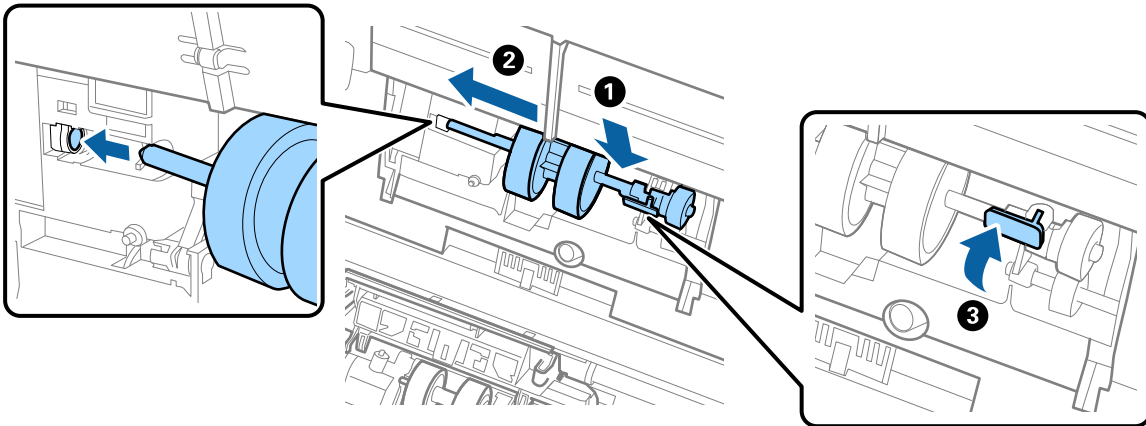

7. Put the edge of the cover of the pickup roller into the groove and slide it. Close the cover firmly.

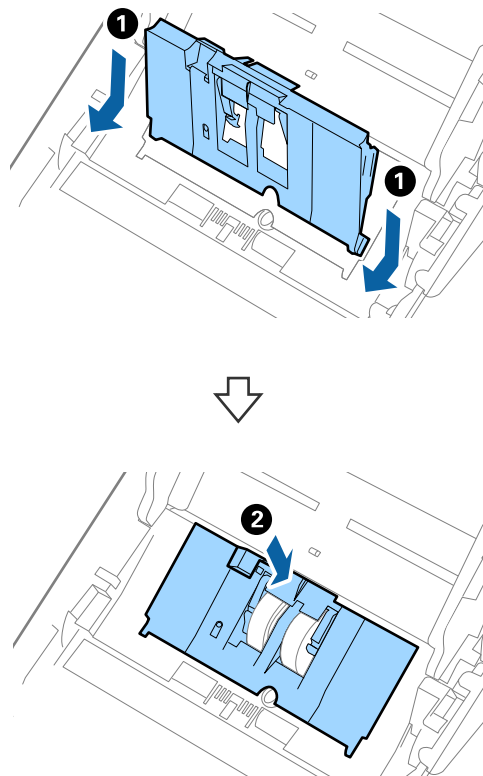

! *Important:*

- Make sure the pick up cover is closed correctly.*
- Make sure the pickup rollers are installed correctly if the cover is hard to close.*
- Do not install the cover while it is raised.*

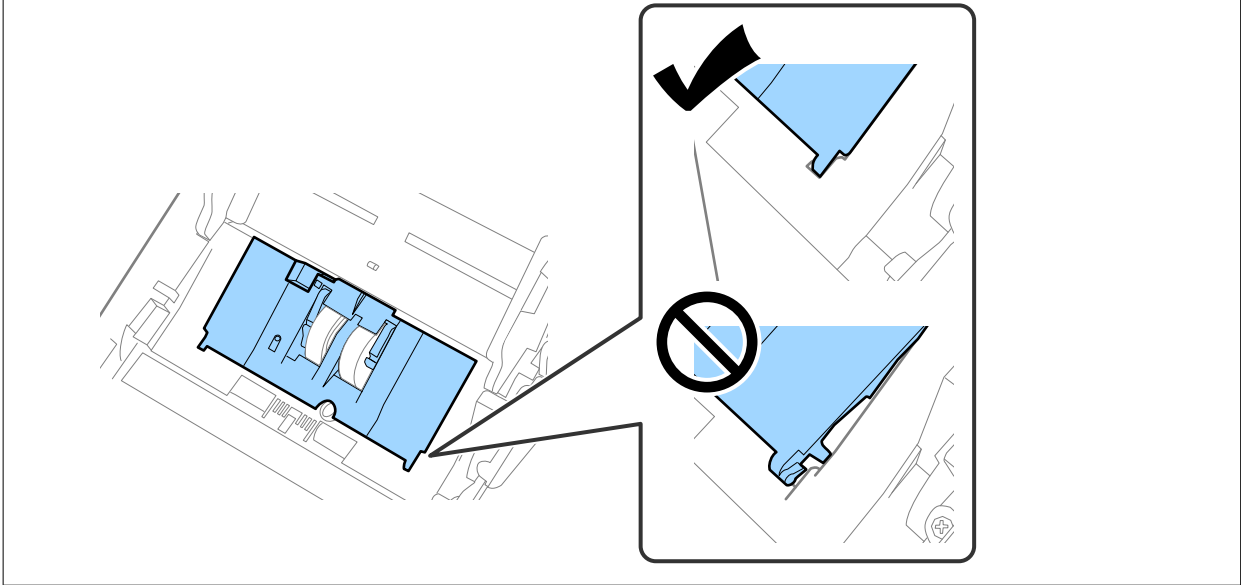

8. Push the hooks on both ends of the separation roller cover to open the cover.

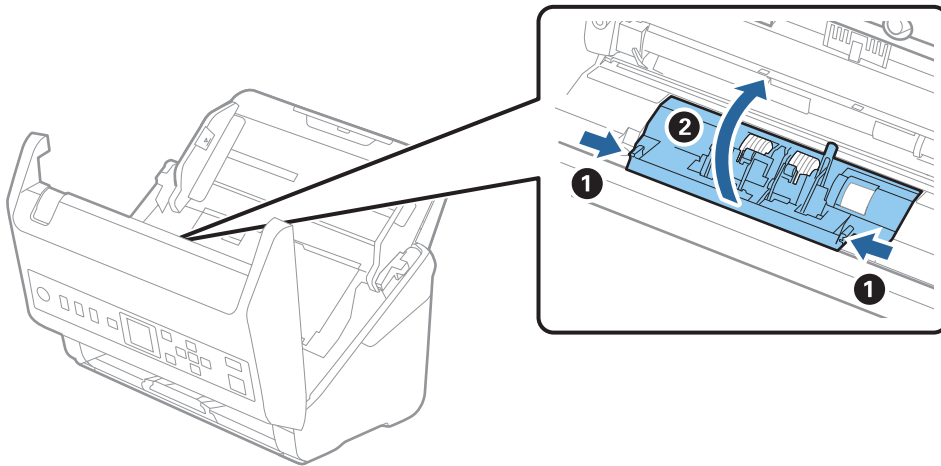

9. Lift the left side of the separation roller, and then slide and remove the installed separation rollers.

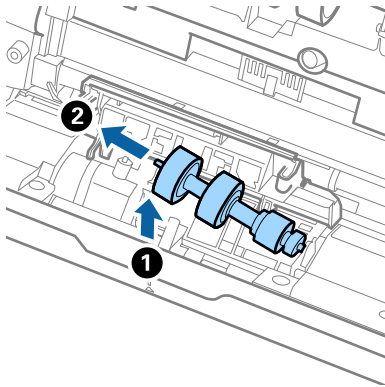

10. Insert the new separation roller axis into the hole on the right side, and then lower the roller.

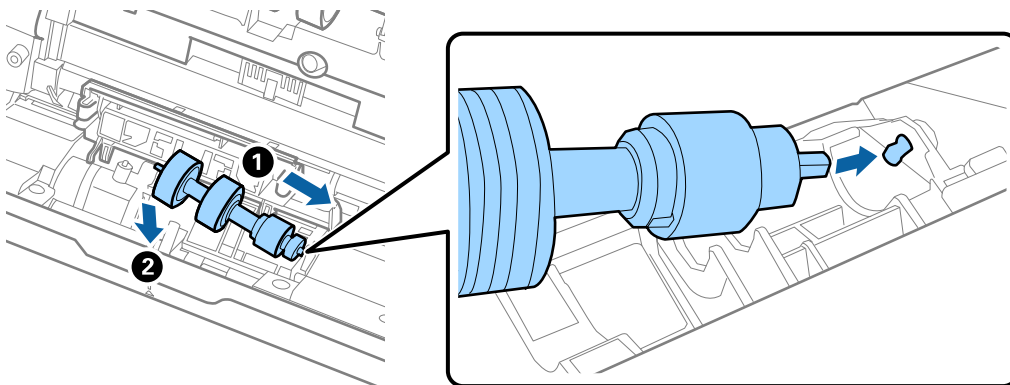

11. Close the separation roller cover.



Important:

If the cover is hard to close, make sure the separation rollers are installed correctly.

12. Close the scanner cover.
13. Plug in the AC adapter, and then turn on the scanner.
14. Reset the scan number on the control panel.

Note:

Dispose of the pickup roller and the separation roller following the rules and regulations of your local authority. Do not disassemble them.

Related Information

➔ [“Roller Assembly Kit Codes” on page 26](#)

Resetting the Number of Scans

Reset the number of scans after replacing the roller assembly kit.

1. Select **Device Information** on the home screen using the ◀▶ button, and then press the **OK** button.
2. Select **Number of Scans After Replacing Roller** using the ◀▶ button, and then press the **OK** button.
3. Press the **OK** button to reset the number of scans.

Related Information

➔ [“Replacing the Roller Assembly Kit” on page 177](#)

Energy Saving

You can save energy by using sleep mode or auto power off mode when no operations are performed by the scanner. You can set the time period before the scanner enters sleep mode and turns off automatically. Any increase will affect the product's energy efficiency. Consider the environment before making any changes.

1. Select **Settings** on the home screen using the ◀▶ button, and then press the **OK** button.
2. Select **Basic Settings** using the ◀▶ button, and then press the **OK** button.
3. Select **Sleep Timer** or **Power Off Timer** using the ◀▶ button, and then press the **OK** button.

Note:

Available features may vary depending on the location of purchase.

4. Check the settings, and change them if necessary.
5. Press the **OK** button to set the timer.

Transporting the Scanner

When you need to transport the scanner to move or for repairs, follow the steps below to pack the scanner.

1. Press the ⏻ button to turn off the scanner.
2. Unplug the AC adapter.
3. Remove the cables and the devices.

4. Close the input tray extension and output tray.

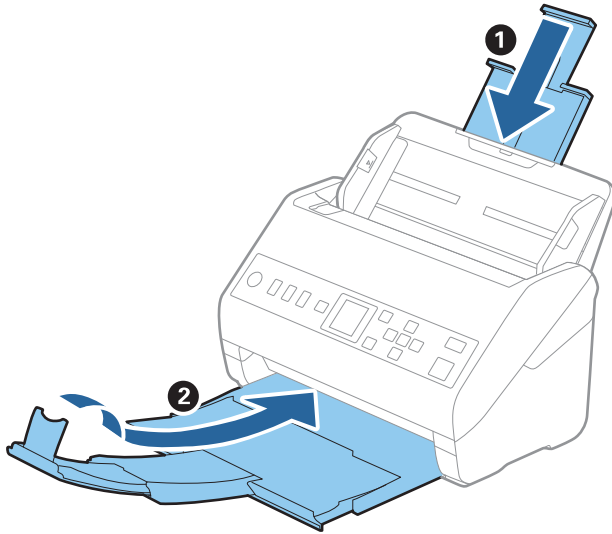

Important:

Make sure you close the output tray securely; otherwise it may be damaged during transport.

5. Remove the input tray.

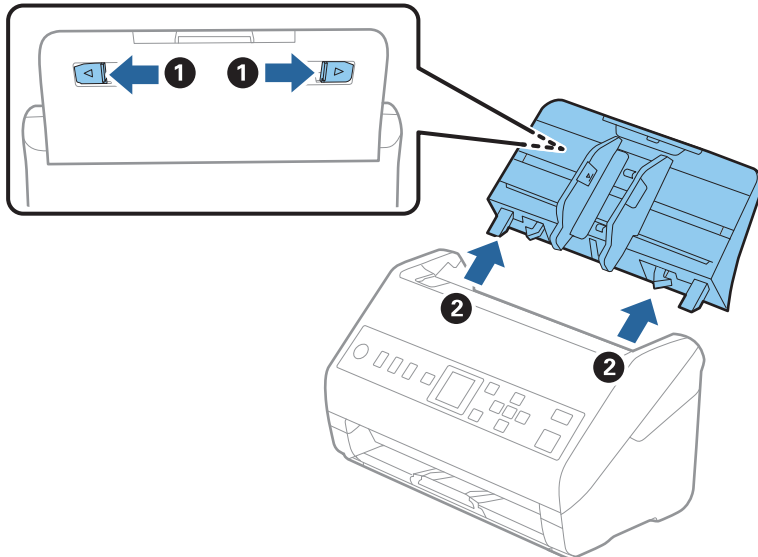

6. Attach the packing materials that came with the scanner, and then repack the scanner in its original box or a sturdy box.

Updating Applications and Firmware

You may be able to clear certain problems and improve or add functions by updating the applications and the firmware. Make sure you use the latest version of the applications and firmware.

 **Important:**

- Do not turn off the computer or the scanner while updating.

1. Make sure that the scanner and the computer are connected, and the computer is connected to the internet.
2. Start EPSON Software Updater, and update the applications or the firmware.
 - Windows 10
Click the start button, and then select **Epson Software > EPSON Software Updater**.
 - Windows 8.1/Windows 8
Enter the application name in the search charm, and then select the displayed icon.
 - Windows 7
Click the start button, and then select **All Programs** or **Programs > Epson Software > EPSON Software Updater**.
 - Mac OS
Select **Finder > Go > Applications > Epson Software > EPSON Software Updater**.

Note:

If you cannot find the application you want to update in the list, you cannot update using the EPSON Software Updater. Check for the latest versions of the applications on your local Epson website.

<http://www.epson.com>

Updating Firmware Using Web Config

When the scanner can connect to the Internet, you can update the firmware from Web Config.

1. Access Web Config and select the **Device Management** tab > **Firmware Update**.
2. Click **Start**, and then follow the on-screen instructions.

The firmware confirmation starts, and the firmware information is displayed if the updated firmware exists.

Note:

You can also update the firmware using Epson Device Admin. You can visually confirm the firmware information on the device list. It is useful when you want to update multiple devices' firmware. See the Epson Device Admin guide or help for more details.

Related Information

- ➔ [“Application for Configuring Scanner Operations \(Web Config\)” on page 23](#)

Solving Problems

Scanner Problems.	186
Problems when Preparing Network Scanning.	187
Problems Starting Scanning.	188
Paper Feeding Problems.	194
Scanned Image Problems.	197
Uninstalling and Installing Applications.	202

Scanner Problems

Checking Error Messages on the Control Panel

If an error message is displayed on the control panel, follow the on-screen instructions or the solutions below to solve the problem.

Note:

See the following if an error message is displayed when scanning to a network folder.

“Messages are Displayed on the Control Panel when Scanning to a Network Folder” on page 192

Messages	Solutions
Computer not found. For details, see your documentation.	<ul style="list-style-type: none"> <input type="checkbox"/> Make sure the scanner is connected to your computer properly. <input type="checkbox"/> Install Epson Scan 2 and Document Capture Pro/ Document Capture on your computer. <input type="checkbox"/> Install the latest version of the application. <input type="checkbox"/> Make sure the AC adapter is securely connected to the scanner and an electrical outlet. Check that the electrical outlet is working. Plug another device into the electrical outlet and check that you can turn the power on. <input type="checkbox"/> Check the firewall settings for Epson software. <input type="checkbox"/> Set the same group for the scanner and the computer. <input type="checkbox"/> Search for the computer again.
Scanner error. For details, see your documentation.	Turn the power off and on again. If the error continues to occur, contact your local dealer.
RECOVERY MODE	<p>The scanner has started in recovery mode because the firmware update failed. Follow the steps below to try to update the firmware again.</p> <ol style="list-style-type: none"> 1. Connect the computer and the scanner with a USB cable. 2. Visit your local Epson website for further instructions.

Related Information

➔ [“Updating Applications and Firmware” on page 183](#)

➔ [“Installing Your Applications” on page 203](#)

The Scanner Does Not Turn On

- Make sure the AC adapter is securely connected to the scanner and an electrical outlet.
- Check that the electrical outlet is working. Plug another device into the electrical outlet and check that you can turn the power on.

Forgot Your Administrator's Password

You need help from service personnel. Contact your local dealer.

Problems when Preparing Network Scanning

Hints to Solving Problems

Checking the error message

When trouble has occurred, first check whether there are any messages on the scanner's control panel or driver screen. If you have the notification email set when the events occur, you can promptly learn the status.

Checking the communication status

Check the communication status of server computer or client computer by using the command such as ping and ipconfig.

Connection test

For checking the connection between the scanner to the mail server, perform the connection test from the scanner. Also, check the connection from the client computer to the server to check the communication status.

Initializing the settings

If the settings and communication status show no problem, the problems may be solved by disabling or initializing the network settings of the scanner, and then setting up again.

Cannot Access Web Config

■ **The IP address is not assigned to the scanner.**

Solutions

A valid IP address may not be assigned to the scanner. Configure the IP address using the scanner's control panel. You can confirm the current setting information from the scanner's control panel.

■ **Web browser does not support the Encryption Strength for SSL/TLS.**

Solutions

SSL/TLS has the Encryption Strength. You can open Web Config by using a web browser that supports bulk encryptions as indicated below. Check you are using the a supported browser.

80bit: AES256/AES128/3DES

112bit: AES256/AES128/3DES

128bit: AES256/AES128

192bit: AES256

256bit: AES256

■ CA-signed Certificate is expired.

Solutions

If there is a problem with the expiration date of the certificate, "The certificate has expired" is displayed when connecting to Web Config with SSL/TLS communication (https). If the message appears before its expiration date, make sure that the scanner's date is configured correctly.

■ The common name of the certificate and the scanner do not match.

Solutions

If the common name of the certificate and the scanner do not match, the message "The name of the security certificate does not match..." is displayed when accessing Web Config using SSL/TLS communication (https). This happens because the following IP addresses do not match.

- The scanner's IP address entered to common name for creating a Self-signed Certificate or CSR
- IP address entered to web browser when running Web Config

For Self-signed Certificate, update the certificate.

For CA-signed Certificate, take the certificate again for the scanner.

■ The proxy server setting of local address is not set to web browser.

Solutions

When the scanner is set to use a proxy server, configure the web browser not to connect to the local address via the proxy server.

- Windows:

Select **Control Panel > Network and Internet > Internet Options > Connections > LAN settings > Proxy server**, and then configure not to use the proxy server for LAN (local addresses).

- Mac OS:

Select **System Preferences > Network > Advanced > Proxies**, and then register the local address for **Bypass proxy settings for these Hosts & Domains**.

Example:

192.168.1.*: Local address 192.168.1.XXX, subnet mask 255.255.255.0

192.168.*.*: Local address 192.168.XXX.XXX, subnet mask 255.255.0.0

Problems Starting Scanning

Cannot Start Scanning from Computer

Make sure the smart device and the scanner are connected correctly.

The cause and solution to the problem differ depending on whether or not they are connected.

Checking the Connection Status (Windows)

Use Epson Scan 2 Utility to check the connection status.

Note:

Epson Scan 2 Utility is an application supplied with the scanner software.

1. Start the Epson Scan 2 Utility.
 - ❑ Windows 10
Click the start button, and then select **EPSON > Epson Scan 2 Utility**.
 - ❑ Windows 8.1/Windows 8
Enter the application name in the search charm, and then select the displayed icon.
 - ❑ Windows 7
Click the start button, and then select **All Programs** or **Programs > EPSON > Epson Scan 2 Utility**.
2. On the **Epson Scan 2 Utility** screen, open the **Scanner** list, and then click **Settings** to open the **Scanner Settings** screen.
If the **Scanner Settings** screen is already displayed instead of the **Epson Scan 2 Utility** screen, go to the next.
3. If the scanner is not displayed on the **Scanner Settings** screen, your scanner is not detected.
Click **Add**, and then add your scanner on the **Add Network Scanner** screen.

If you cannot search for the scanner or cannot scan even if the correct scanner is selected, see the related information.

Related Information



- ➔ [“Cannot connect to a Network” on page 190](#)
- ➔ [“The Scanner Cannot Connect by USB” on page 191](#)
- ➔ [“Cannot Scan Even Though a Connection has been Correctly Established” on page 191](#)

Checking the Connection Status (Mac OS)

Use Epson Scan 2 Utility to check the connection status.

Note:

Epson Scan 2 Utility is an application supplied with the scanner software.

1. Start the Epson Scan 2 Utility.
Select **Go > Applications > Epson Software > Epson Scan 2 Utility**.
2. On the **Epson Scan 2 Utility** screen, open the **Scanner** list, and then click **Settings** to open the **Scanner Settings** screen.
If the **Scanner Settings** screen is already displayed instead of the **Epson Scan 2 Utility** screen, go to the next
3. If the scanner is not displayed on the **Scanner Settings** screen, your scanner is not detected.
Click the  icon, and then allow the software to make changes.
4. Click the  icon, and then add your scanner on the **Add Network Scanner** screen.

If you cannot search for the scanner or cannot scan even if the correct scanner is selected, see the related information.

Related Information

- ➔ [“Cannot connect to a Network” on page 190](#)
- ➔ [“The Scanner Cannot Connect by USB” on page 191](#)
- ➔ [“Cannot Scan Even Though a Connection has been Correctly Established” on page 191](#)

Cannot connect to a Network

The problem could be one of the following issues.

■ There is a problem with the network settings on the computer.

Solutions

Try accessing any website from your computer to make sure that your computer's network settings are correct. If you cannot access any website, there is a problem on the computer.

Check the network connection of the computer. See the documentation provided with the computer for details.

■ The scanner has been connected by Ethernet using devices that support IEEE802.3az (Energy Efficient Ethernet).

Solutions

When you connect the scanner by Ethernet using devices that support IEEE802.3az (Energy Efficient Ethernet), the following problems may occur depending on the hub or router that you are using.

- Connection becomes unstable, the scanner is connected and disconnected again and again.
- Cannot connect to the scanner.
- The communication speed becomes slow.

Follow the steps below to disable IEEE802.3az for the scanner and then connect.

1. Remove the Ethernet cable connected to the computer and the scanner.
2. When IEEE802.3az for the computer is enabled, disable it.
See the documentation provided with the computer for details.
3. Connect the computer and the scanner with an Ethernet cable directly.
4. On the scanner, check the network settings.
Select **Settings** > **Network Status** > **IP Address**.
5. Check the scanner's IP address.
6. On the computer, access Web Config.
Launch a Web browser, and then enter the scanner's IP address.
[“Running Web Config on a Web Browser” on page 23](#)
7. Select the **Network** tab > **Wired LAN**.
8. Select **OFF** for **IEEE 802.3az**.

9. Click **Next**.
 10. Click **OK**.
 11. Remove the Ethernet cable connected to the computer and the scanner.
 12. If you disabled IEEE802.3az for the computer in step 2, enable it.
 13. Connect the Ethernet cables that you removed in step 1 to the computer and the scanner.
- If the problem still occurs, devices other than the scanner may be causing the problem.

■ **The scanner is off.**

Solutions

Make sure the scanner is turned on.

Also, wait until the status light stops flashing indicating that the scanner is ready to scan.

The Scanner Cannot Connect by USB

The following causes can be considered.

■ **The USB cable is not plugged into the electrical outlet correctly.**

Solutions

Connect the USB cable securely to the scanner and the computer.

■ **There is a problem with the USB hub.**

Solutions

If you are using a USB hub, try to connect the scanner directly to the computer.

■ **There is a problem with the USB cable or the USB inlet.**

Solutions

If the USB cable cannot be recognized, change the port, or change the USB cable.

■ **The scanner is off.**

Solutions

Make sure the scanner is turned on.

Also, wait until the status light stops flashing indicating that the scanner is ready to scan.

Cannot Scan Even Though a Connection has been Correctly Established

■ **Required applications are not installed on your computer.**

Solutions

Make sure the following applications are installed:

- Document Capture Pro (Windows) or Document Capture (Mac OS)

- Epson Scan 2

If the applications are not installed, install them again.

➔ [“Installing Your Applications” on page 203](#)

Job is not assigned to the scanner button.

Solutions

Check that the job is correctly assigned to the scanner button in Document Capture Pro (Windows) or Document Capture (Mac OS).

If you are using any TWAIN-compliant programs, the correct scanner is not selected as the source setting. (Windows)

Solutions

Make sure that you select the correct scanner from your programs list.

Cannot Save Scanned Images to the Shared Folder

Messages are Displayed on the Control Panel when Scanning to a Network Folder

When error messages are displayed on the control panel, check the message itself or the following list to solve the problems.

Messages	Solutions
DNS error. Check DNS settings.	<p>Cannot connect to the computer. Check the following.</p> <ul style="list-style-type: none"> <input type="checkbox"/> Make sure that the address in the contacts list on the scanner and the address of the shared folder are the same. <input type="checkbox"/> If the IP address of the computer is static and is set manually, change the computer name in the network path to the IP address. Example: \\EPSON02\SCAN to \\192.168.xxx.xxx\SCAN <input type="checkbox"/> Make sure that the computer is turned on and does not sleep. If the computer sleeps, you cannot save scanned images to the shared folder. <input type="checkbox"/> Temporarily disable the computer's Firewall and security software. If this clears the error, check the settings in the security software. <input type="checkbox"/> If Public network is selected as the network place, you cannot save the scanned images to the shared folder. Set the forward settings for each port. <input type="checkbox"/> If you are using a laptop computer and the IP address is set as DHCP, the IP address may change when reconnecting to the network. Obtain the IP address again. <input type="checkbox"/> Make sure the DNS setting is correct. Contact your network administrator about the DNS settings. <input type="checkbox"/> The computer name and the IP address may differ when the management table of the DNS server is not updated. Contact your DNS server administrator.
Authentication error. Check the location, user name and password.	<p>Make sure the user name and the password are correct on the computer and the contacts on the scanner. Also, make sure that the password has not expired.</p>

Messages	Solutions
Communication error. Check the network connection.	Cannot communicate with a network folder that is registered on the contacts list. Check the following. <ul style="list-style-type: none"> <input type="checkbox"/> Make sure that the address in the contacts list on the scanner and the address of the shared folder are the same. <input type="checkbox"/> Access rights for the user in the contacts list should be added on the Sharing tab and the Security tab of the shared folder's properties. Also, the permissions for the user should be set to "allowed".
The file name is already in use.	Change the file name settings. Otherwise, move or delete the files, or change the file name on the shared folder.
Scanned files are too large. Only XX pages have been sent.	There is not enough disk space on the computer. Increase the free space on the computer.

Checking the Point where the Error Occurred

When saving scanned images to the shared folder, saving process proceeds as following. You can then check the point where the error occurred.

Items	Operation	Error Messages
Connecting	Connect to the computer from the scanner.	DNS error. Check DNS settings.
Logging on to the computer	Log on to the computer with the user name and the password.	Authentication error. Check the location, user name and password.
Checking the folder to save	Check the network path of the shared folder.	Communication error. Check the network connection.
Checking the file name	Check if there is a file with the same name as the file you want to save in the folder.	The file name is already in use.
Writing the file	Write a new file.	Scanned files are too large. Only XX pages have been sent.

Saving the Scanned Images Takes a Long Time

It takes a long time for the name resolution to correspond to the "Domain Name" and the "IP Address".

Check the following points.

- Make sure the DNS setting is correct.
- Make sure each DNS setting is correct when checking the Web Config.
- Make sure the DNS domain name is correct.

Cannot Send Scanned Images to an Email

- Make sure that the entered email address is working.
- Make sure that the email server settings are correct.

- Contact the email server administrator to make sure the server is running.

Related Information

- ➔ [“Checking a Mail Server Connection” on page 63](#)

Paper Feeding Problems

Multiple Originals Are Fed (Double Feed)

Check the following when a double feed occurs.

- When originals are jammed inside the scanner, open the scanner cover and remove the originals, and then close the scanner cover.
- Check the scanned image, and then scan the originals again if necessary.

If multiple originals are fed frequently, try the following.

- If you load unsupported originals, the scanner may feed multiple originals at a time.
- Clean the rollers inside the scanner.
- Reduce the number of originals being placed at a time.
- Select **Slow** on the control panel to slow down the scanning speed.

Select **Settings** from the home screen > **Scanner Settings** > **Slow**, and then set it to **On**.

- Use **Automatic Feeding Mode**, and scan originals one by one.

When you are using Document Capture Pro, you can open the Epson Scan 2 window by pressing the **Detailed Settings** button on the **Scan Settings** screen.

Related Information

- ➔ [“Scanning Different Sizes or Types of Originals One by One \(Automatic Feeding Mode\)” on page 124](#)
- ➔ [“Cleaning Inside the Scanner” on page 172](#)
- ➔ [“Removing Jammed Originals from the Scanner” on page 194](#)

Removing Jammed Originals from the Scanner

If an original has jammed inside the scanner, follow these steps to remove it.

1. Remove all originals remaining in the input tray.

2. Pull the lever and open the scanner cover.

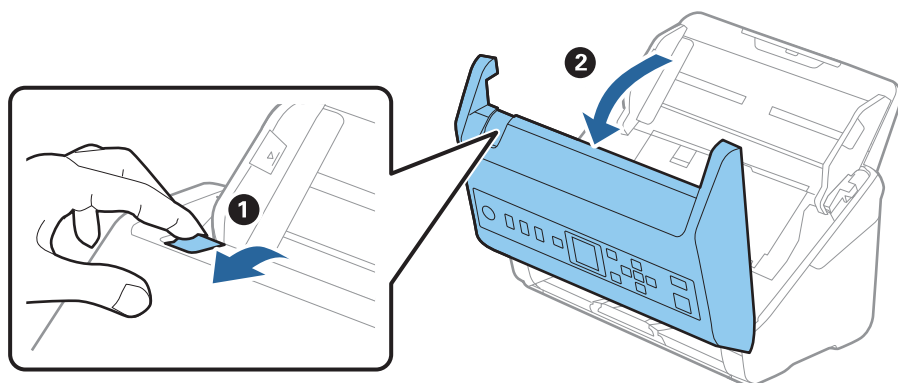

3. Carefully remove any originals remaining inside the scanner.

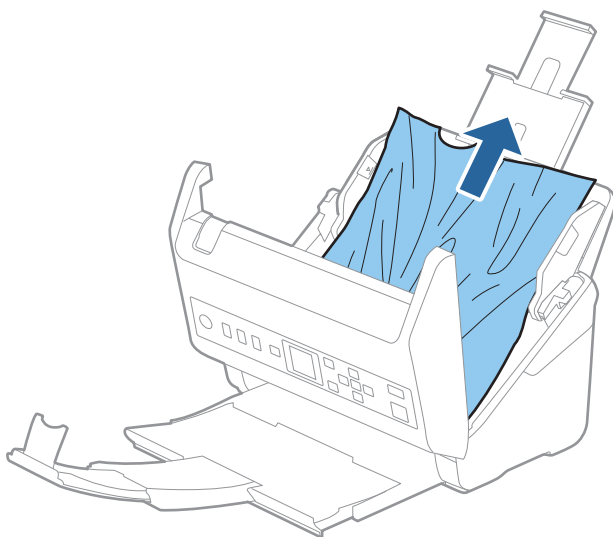

4. If you cannot pull originals straight up, carefully pull out any jammed originals from the output tray in the direction of the arrow.

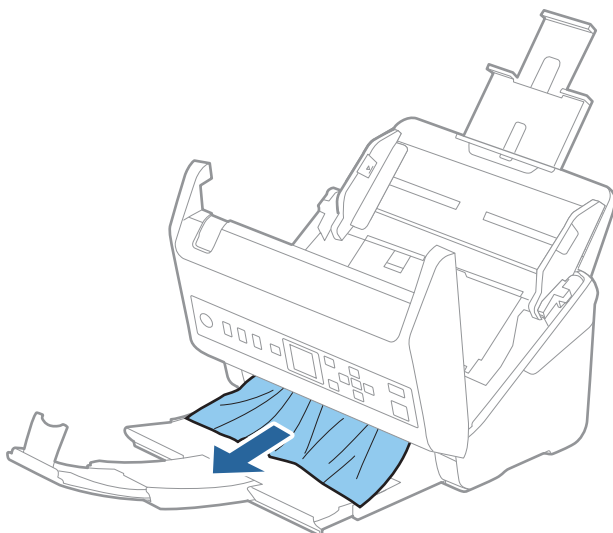



Important:

Make sure there is no paper inside the scanner.

5. Close the scanner cover.

Related Information

- ➔ [“Multiple Originals Are Fed \(Double Feed\)” on page 194](#)
- ➔ [“Paper Protection Does not Work Correctly” on page 196](#)

The Original Jams in the Scanner Frequently

If the original jams in the scanner frequently, try the following.

- Select **Slow** on the control panel to slow down the scanning speed.
Select **Settings** from the home screen > **Scanner Settings** > **Slow**, and then set it to **On**.
- Clean the rollers inside the scanner.
- If the ejected originals get stuck in the output tray, store the output tray and do not use it.

Related Information

- ➔ [“Cleaning Inside the Scanner” on page 172](#)
- ➔ [“Multiple Originals Are Fed \(Double Feed\)” on page 194](#)
- ➔ [“Paper Protection Does not Work Correctly” on page 196](#)

Paper Protection Does not Work Correctly

Depending on the original and the level you set, this feature may not work correctly.

- Select **Off** to disable the feature when scanning plastic cards or thick paper.
- When misdetection occurs frequently, lower the level of this feature.
- If your original is damaged, check that this feature is enabled. If it is already enabled, increase the level of protection for the feature.

Related Information

- ➔ [“Scanner Settings” on page 167](#)
- ➔ [“Removing Jammed Originals from the Scanner” on page 194](#)

The Originals Get Dirty

Clean the inside of the scanner.

Related Information

- ➔ [“Cleaning Inside the Scanner” on page 172](#)

Scanning Speed Slows Down when Scanning Continuously

When scanning continuously using the ADF, scanning slows down to prevent the scanner mechanism from overheating and being damaged. However, you can continue scanning.

To regain normal scanning speed, leave the scanner idle for at least 30 minutes. Scanning speed does not recover even if the power is off.

Scanning Takes a Long Time

- The scanning speed may slow down depending on the scanning conditions, such as high resolution, image adjustment features, file format, and so on.
- Computers with USB 3.0 (SuperSpeed) or USB 2.0 (Hi-Speed) ports can scan faster than those with USB 1.1 ports. If you are using a USB 3.0 or USB 2.0 port with the scanner, make sure it meets the system requirements.
- When using security software, exclude the TWAIN.log file from monitoring, or set the TWAIN.log as a read-only file. For more information on your security software's functions, see the help and so on supplied with the software. The TWAIN.log file is saved in the following locations.

C:\Users*(user name)*\AppData\Local\Temp

Scanned Image Problems

Straight Lines Appear when Scanning from ADF

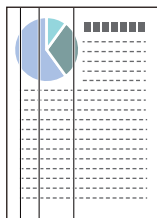

- Clean the ADF.
Straight lines may appear in the image when trash or dirt gets into the ADF.
- Remove any trash or dirt that adheres to the original.
- Using **Detect Glass Dirt** feature, alert message appears when dirt is detected on the scanner glass.
Select **Settings** on the home screen > **Scanner Settings** > **Detect Glass Dirt**, and then select **On-Low** or **On-High**.
When an alert is displayed, clean the glass surfaces inside your scanner using a genuine Epson cleaning kit or a soft cloth.

Note:

- Depending on the dirt, it may not be detected correctly.
- If the detection does not work correctly, change the setting.
Select **On-High** if the dirt is not detected. Select **On-Low** or **Off** if the alert is displayed by a misdetection.

Related Information

➔ [“Cleaning Inside the Scanner” on page 172](#)

Glass Dirt Alert Does Not Disappear

If the glass dirt alert screen appears after cleaning the inside of the scanner, check the glass surface again. If there are scratches on the glass, they will be detected as a glass dirt.

Glass part will be required to replace. Contact your local dealer to repair.

Colors Are Uneven in the Scanned Image

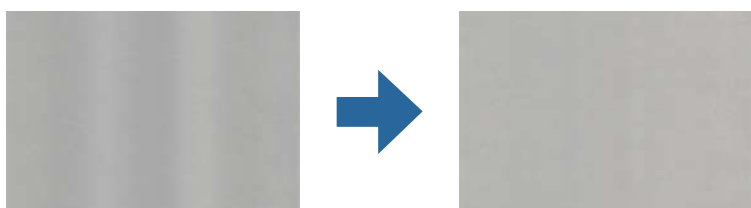

If the scanner is subject to strong light such as direct sunlight, the sensor inside the scanner misdetects the light and colors in the scanned image become uneven.

- Change the orientation of the scanner so that no strong light is falling on the front of the scanner.
- Move the scanner to a location where it will not be subjected to strong light.

Expanding or Contracting the Scanned Image

When expanding or contracting the scanned image, you can adjust the expansion ratio by using the **Adjustments** feature in Epson Scan 2 Utility. This feature is only available for Windows.

Note:

Epson Scan 2 Utility is one of the applications supplied with the scanner software.

1. Start Epson Scan 2 Utility.
 - Windows 10
Click the start button, and then select **EPSON > Epson Scan 2 > Epson Scan 2 Utility**.
 - Windows 8.1/Windows 8
Enter the application name in the search charm, and then select the displayed icon.
 - Windows 7
Click the start button, and then select **All Programs or Programs > EPSON > Epson Scan 2 > Epson Scan 2 Utility**.
2. Select the **Adjustments** tab.
3. Use **Expansion/Contraction** to adjust the expansion ratio for scanned images.
4. Click **Set** to apply the settings to the scanner.

Offset Appears in the Background of Images

Images on the back of the original may appear in the scanned image.

- ❑ When **Auto**, **Color**, or **Grayscale** is selected as the **Image Type**:
 - ❑ Check that **Remove Background** is selected in the Epson Scan 2 window. When you are using Document Capture Pro, you can open the window by pressing the **Detailed Settings** button on the **Scan Settings** screen.
Click the **Advanced Settings** tab > **Remove Background**.
 - ❑ Check that **Text Enhancement** is selected.
Document Capture Pro (Windows)/Document Capture (Mac OS X): Click **Scan Settings** > **Text Enhancement**.
Epson Scan 2: Click the **Advanced Settings** tab > **Text Enhancement**.
- ❑ When **Black & White** is selected as the **Image Type**:
 - Check that **Text Enhancement** is selected.
Document Capture Pro (Windows)/Document Capture (Mac OS X): Click **Scan Settings** > **Text Enhancement**.
Epson Scan 2: Click the **Advanced Settings** tab > **Text Enhancement**.
 - Depending on the condition of your scanned image, click **Settings** in the Epson Scan 2 window and try setting a lower level for **Edge Enhancement** or a higher level for **Noise Reduction Level**.

Scanned Image or Text is Blurred

You can adjust the appearance of the scanned image or text by increasing the resolution or adjusting the image quality.

- ❑ Change the resolution, and then scan again.
Set the appropriate resolution for the purpose of your scanned image.
- ❑ Check that **Text Enhancement** is selected.
Document Capture Pro (Windows)/Document Capture (Mac OS X): Click **Scan Settings** > **Text Enhancement**.
Epson Scan 2: Click the **Advanced Settings** tab > **Text Enhancement**.
- ❑ When **Black & White** is selected as the **Image Type**:
 - Depending on the condition of your scanned image, click **Settings** in the Epson Scan 2 window and try setting a lower level for **Edge Enhancement** or a higher level for **Noise Reduction Level**.
- ❑ If you are scanning in JPEG format, try changing the compression level.
Document Capture Pro (Windows)/Document Capture (Mac OS X): Click **Option** on the **Save Settings** screen, and then change the image quality for JPEG.
Epson Scan 2: Click **Image Format** > **Options**, and then change the **Image Quality**.

List of Recommended Resolutions to Suit Your Purpose

See the table and set the appropriate resolution for the purpose of your scanned image.

Purpose	Resolution (Reference)
Displaying on a screen Sending by email	Up to 200 dpi
Using Optical Character Recognition (OCR) Creating a text searchable PDF	200 to 300 dpi
Printing using a printer Sending by fax	200 to 300 dpi

Moiré Patterns (Web-Like Shadows) Appear

If the original is a printed document, moiré patterns (web-like shadows) may appear in the scanned image.

- ❑ Check that **Descreening** is selected in the Epson Scan 2 window. When you are using Document Capture Pro, you can open the window by pressing the **Detailed Settings** button on the **Scan Settings** screen.

Click the **Advanced Settings** tab > **Descreening**.



- ❑ Change the resolution, and then scan again.

The Edge of the Original is Not Scanned when Automatically Detecting the Size of the Original

Depending on the original, the edge of the original may not be scanned when automatically detecting the size of the original.

- ❑ Adjust **Crop Margins for Size "Auto"** in the Epson Scan 2 window. When you are using Document Capture Pro, you can open the window by pressing the **Detailed Settings** button on the **Scan Settings** screen.
Click the **Main Settings** tab > **Document Size** > **Settings**. On the **Document Size Settings** screen, adjust **Crop Margins for Size "Auto"**.
- ❑ Depending on the original, the area of the original may not be detected correctly when using the **Auto Detect** feature. Select the appropriate size of the original from the **Document Size** list.

Note:

If the size of the original you want to scan is not on the list, create the size manually in the Epson Scan 2 window. When you are using Document Capture Pro, you can open the window by pressing the **Detailed Settings** button on the **Scan Settings** screen.

Click the **Main Settings** tab > **Document Size**, and then select **Customize**.

Character is not Recognized Correctly

Check the following to increase the recognition rate of OCR (Optical Character Recognition).

- Check that the original is placed straight.
- Use an original with clear text. Text recognition may decline for the following types of originals.
 - Originals that have been copied a number of times
 - Originals received by fax (at low resolutions)
 - Originals on which the letter spacing or line spacing is too small
 - Originals with ruled lines or underlining over the text
 - Originals with hand-written text
 - Originals with creases or wrinkles
- Paper type made of thermal paper such as receipts may deteriorate due to age or friction. Scan them as soon as possible.
- When saving to Microsoft® Office or **Searchable PDF** files, check that the correct languages are selected.

Cannot Solve Problems in the Scanned Image

If you have tried all of the solutions and have not solved the problem, initialize the application settings by using Epson Scan 2 Utility.

Note:

Epson Scan 2 Utility is one of the applications supplied with the scanner software.

1. Start Epson Scan 2 Utility.
 - Windows 10
Click the start button, and then select **EPSON > Epson Scan 2 Utility**.
 - Windows 8.1/Windows 8
Enter the application name in the search charm, and then select the displayed icon.
 - Windows 7
Click the start button, and then select **All Programs** or **Programs > EPSON > Epson Scan 2 > Epson Scan 2 Utility**.
 - Mac OS
Select **Go > Applications > Epson Software > Epson Scan 2 Utility**.
2. Select the **Other** tab.
3. Click **Reset**.

Note:

If initialization does not solve the problem, uninstall and re-install the scanner driver (Epson Scan 2).

Uninstalling and Installing Applications

Uninstalling Your Applications

You may need to uninstall and then reinstall your applications to solve certain problems or if you upgrade your operating system. Log on to your computer as an administrator. Enter the administrator password if the computer prompts you.

Uninstalling Your Applications for Windows

1. Quit all running applications.
2. Disconnect the scanner from your computer.
3. Open the Control Panel:
 - Windows 10
Right-click the start button or press and hold it, and then select **Control Panel**.
 - Windows 8.1/Windows 8
Select **Desktop > Settings > Control Panel**.
 - Windows 7
Click the start button and select **Control Panel**.
4. Select **Uninstall a program** in **Programs**.
5. Select the application you want to uninstall.
6. Click **Uninstall/Change** or **Uninstall**.

Note:
If the User Account Control window is displayed, click Continue.
7. Follow the on-screen instructions.

Note:
*A message may be displayed prompting you to restart your computer. If it is displayed, make sure **I want to restart my computer now** is selected, and then click **Finish**.*

Uninstalling Your Applications for Mac OS

Note:
Make sure you installed EPSON Software Updater.

1. Download the Uninstaller using EPSON Software Updater.
Once you have downloaded the Uninstaller, you do not need to download it again each time you uninstall the application.
2. Disconnect the scanner from your computer.

3. To uninstall the scanner driver, select **System Preferences** from the Apple menu > **Printers & Scanners** (or **Print & Scan, Print & Fax**), and then remove the scanner from the enabled scanner list.
4. Quit all running applications.
5. Select **Go > Applications > Epson Software > Uninstaller**.
6. Select the application you want to uninstall, and then click Uninstall.



Important:

The Uninstaller removes all drivers for Epson scanners on the computer. If you use multiple Epson scanners and you only want to delete some of the drivers, delete all of them first, and then install the necessary scanner drivers again.

Note:

*If you cannot find the application you want to uninstall in the application list, you cannot uninstall using the Uninstaller. In this situation, select **Go > Applications > Epson Software**, select the application you want to uninstall, and then drag it to the trash icon.*

Installing Your Applications

Follow the steps below to install the necessary applications.

Note:

- Log on to your computer as an administrator. Enter the administrator password if the computer prompts you.
- When reinstalling applications, you need to uninstall them first.

1. Quit all running applications.
2. When installing scanner driver (Epson Scan 2), disconnect the scanner and the computer temporarily.

Note:

Do not connect the scanner and the computer until you are instructed to do so.

3. Install the application by following the instructions on the Website below.

<http://epson.sn>

Note:

For Windows, you can also use the software disc that came with the scanner.

Adding or Replacing the Computer or Devices

Connecting to a Scanner that has been Connected to the Network.	205
Re-setting the Network Connection.	206
Checking the Network Connection Status.	207

Connecting to a Scanner that has been Connected to the Network

When the scanner has already been connected to the network, you can connect a computer or a smart device to the scanner over the network.

Using a Network Scanner from a Second Computer

We recommend using the installer to connect the scanner to a computer. You can run the installer using one of the following methods.

- Setting up from the website

Access the following website, and then enter the product name. Go to **Setup**, and then start setting up.

<http://epson.sn>

- Setting up using the software disc (only for the models that come with a software disc and users with Windows computers with disc drives.)

Insert the software disc into the computer, and then follow the on-screen instructions.

Selecting the Scanner

Follow the on-screen instructions until the following screen is displayed, select the scanner name you want to connect to, and then click **Next**.

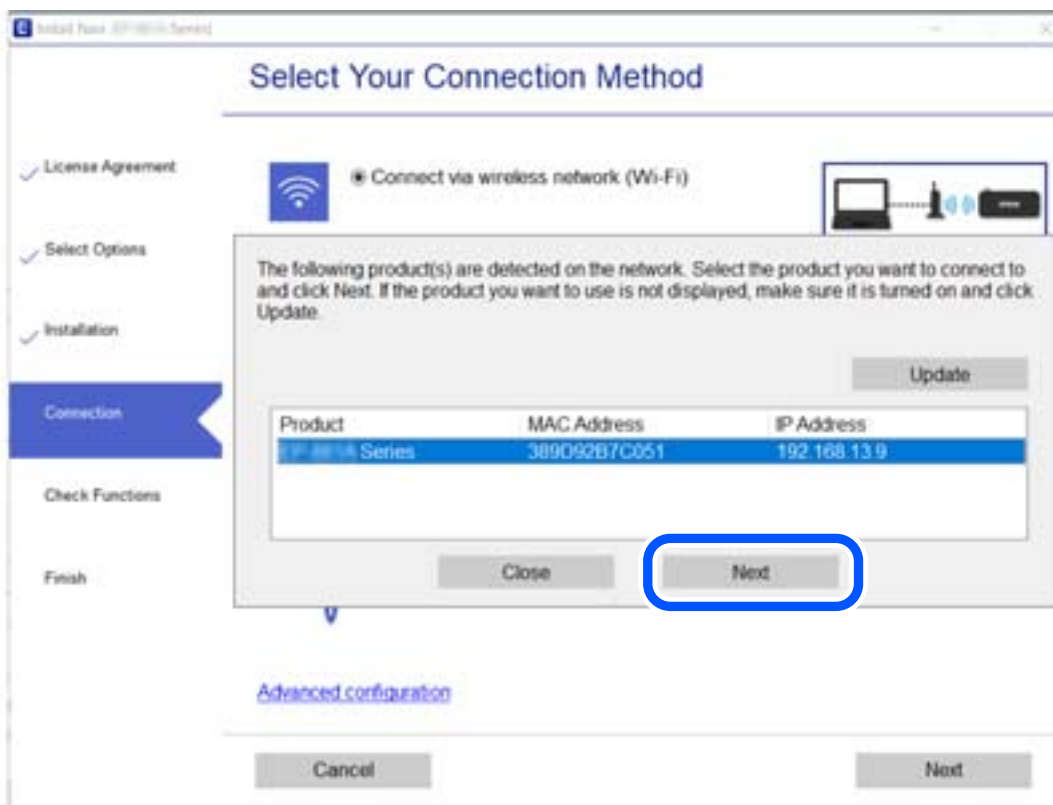

Follow the on-screen instructions.

Re-setting the Network Connection

This section explains how to make the network connection settings and change the connection method when replacing the computer.

When Changing the Computer

When changing the computer, make connection settings between the computer and the scanner.

Making Settings for Connecting to the Computer

We recommend using the installer to connect the scanner to a computer. You can run the installer using one of the following methods.

- Setting up from the website

Access the following website, and then enter the product name. Go to **Setup**, and then start setting up.

<http://epson.sn>

- Setting up using the software disc (only for the models that come with a software disc and users with Windows computers with disc drives.)

Insert the software disc into the computer, and then follow the on-screen instructions.

Follow the on-screen instructions.

Changing the Connection Method to the Computer

This section explains how to change the connection method when the computer and the scanner have been connected.

Changing from USB to a Network Connection

Using the installer and re-set up in a different connection method.

- Setting up from the website

Access the following website, and then enter the product name. Go to **Setup**, and then start setting up.

<http://epson.sn>

- Setting up using the software disc (only for the models that come with a software disc and users with Windows computers with disc drives.)

Insert the software disc into the computer, and then follow the on-screen instructions.

Selecting Change the Connection Methods

Follow the on-screen instructions. On the **Select Your Operation** screen, select **Set up Scanner connection again (for new network router or changing USB to network, etc.)**, and then click **Next**.

Select **Connect via wired LAN (Ethernet)**, and then click **Next**.

Follow the on-screen instructions to finish setup.

Checking the Network Connection Status

You can check the network connection status in the following way.

Checking the Network Connection Status from the Control Panel

You can check the network connection status using the network icon or the network information on the scanner's control panel.

Checking the Network Connection Status using the Network Icon

You can check the network connection status using the network icon on the scanner's home screen.



Checking the Network of the Computer (Windows only)

By using the command prompt, check the connection status of the computer and the connection path to the scanner. This will lead you to solve the problems.

ipconfig command

Display the connection status of the network interface that is currently used by the computer.

By comparing the setting information with actual communication, you can check whether the connection is correct. In case there are multiple DHCP servers on the same network, you can find out the actual address assigned to the computer, the referred DNS server, etc.

Format : ipconfig /all

Examples :

```

Administrator: Command Prompt
c:\>ipconfig /all
Windows IP Configuration

Host Name . . . . . : WIN2012R2
Primary Dns Suffix . . . . . : pubs.net
Node Type . . . . . : Hybrid
IP Routing Enabled. . . . . : No
WINS Proxy Enabled. . . . . : No
DNS Suffix Search List. . . . . : pubs.net

Ethernet adapter Ethernet:

Connection-specific DNS Suffix . . . :
Description . . . . . : Gigabit Network Connection
Physical Address. . . . . : XX-XX-XX-XX-XX-XX
DHCP Enabled. . . . . : No
Autoconfiguration Enabled . . . . . : Yes
Link-local IPv6 Address . . . . . : fe80::38fb:7546:18a8:d20e%14(Preferred)
IPv4 Address. . . . . : 192.168.111.10(Preferred)
Subnet Mask . . . . . : 255.255.255.0
Default Gateway . . . . . : 192.168.111.1
DHCPv6 IAID . . . . . : 283142549
DHCPv6 Client DUID. . . . . : 00-01-00-01-20-40-2F-45-00-1D-73-6A-44-08
DNS Servers . . . . . : 192.168.111.2
NetBIOS over Tcpip. . . . . : Enabled

Tunnel adapter isatap.{00000000-ABCD-EFGH-IJK-LMNOPQRSTUUV}>:

Media State . . . . . : Media disconnected
Connection-specific DNS Suffix . . . :
Description . . . . . : Microsoft ISATAP Adapter #2
Physical Address. . . . . : 00-00-00-00-00-00-E0
DHCP Enabled. . . . . : No
Autoconfiguration Enabled . . . . . : Yes

c:\>_
    
```

pathping command

You can confirm the list of routers passing through the destination host and the routing of communication.

Format : pathping xxx.xxx.xxx.xxx

Examples : pathping 192.0.2.222

```

Administrator: Command Prompt
c:\>pathping 192.168.111.20
Tracing route to EPSONAB12AB [192.168.111.20]
over a maximum of 30 hops:
  0  WIN2012R2.pubs.net [192.168.111.10]
  1  EPSONAB12AB [192.168.111.20]

Computing statistics for 25 seconds...
Hop  RTT      Source to Here   This Node/Link   Address
  0      0/ 100 = 0%      0/ 100 = 0%      WIN2012R2.pubs.net [192.168.111.10]
  1  38ms      0/ 100 = 0%      0/ 100 = 0%      EPSONAB12AB [192.168.111.20]

Trace complete.

c:\>_
    
```

Administrator Information

Connect the Scanner to the Network Manually.	210
Introduction of Product Security Features.	212
Administrator Settings.	212
Disabling the External Interface.	217
Monitoring a Remote Scanner.	217
Backing Up the Settings.	219
Advanced Security Settings.	220

Connect the Scanner to the Network Manually

You can connect a wired LAN with a static IP address by using the installer on the software disc supplied.

Before Making Network Connection

To connect to the network, check the connection method and setting information for connection in advance.

Gathering Information on the Connection Setting

Prepare the necessary setting information to connect. Check the following information in advance.

Divisions	Items	Note
LAN connection information	<input type="checkbox"/> IP address <input type="checkbox"/> Subnet mask <input type="checkbox"/> Default gateway	Decide the IP address to assign to the scanner. When you assign the IP address statically, all values are required. When you assign the IP address dynamically using the DHCP function, this information is not required because it is set automatically.
DNS server information	<input type="checkbox"/> IP address for primary DNS <input type="checkbox"/> IP address for secondary DNS	These are required when specifying DNS servers. The secondary DNS is set when the system has a redundant configuration and there is a secondary DNS server. If you are in a small organization and do not set the DNS server, set the IP address of the router.
Proxy server information	<input type="checkbox"/> Proxy server name	Set this when your network environment uses the proxy server to access the internet from the intranet, and you use the function that the scanner directly accesses to the internet. For the following functions, the scanner directly connects to the internet . <input type="checkbox"/> Epson Connect Services <input type="checkbox"/> Cloud services of other companies <input type="checkbox"/> Firmware updating <input type="checkbox"/> Sending scanned images to SharePoint(WebDAV)
Port number information	<input type="checkbox"/> Port number to release	Check the port number used by the scanner and computer, then release the port that is blocked by a firewall, if necessary. See the following for the port number used by the scanner. "Using Port for the Scanner" on page 251

IP Address Assignment

These are the following types of IP address assignment.

Static IP address:

Assign the predetermined IP address to the scanner (host) manually.

The information to connect to the network (subnet mask, default gateway, DNS server and so on) need to be set manually.

The IP address does not change even when the device is turned off, so this is useful when you want to manage devices with an environment where you cannot change the IP address or you want to manage devices using the IP address. We recommend settings to the scanner, server, etc. that many computers access. Also, when using security features such as IPsec / IP filtering, assign a fixed IP address so that the IP address does not change.

Automatic assignment by using DHCP function (dynamic IP address):

Assign the IP address automatically to the scanner (host) by using the DHCP function of the DHCP server or router.

The information to connect to the network (subnet mask, default gateway, DNS server and so on) is set automatically, so you can easily connect the device to the network.

If the device or the router is turned off, or depending on the DHCP server settings, IP address may change when re-connecting.

We recommend managing devices other than the IP address and communicating with protocols that can follow the IP address.

Note:

When you use the IP address reservation function of the DHCP, you can assign the same IP address to the devices at any time.

DNS Server and Proxy Server

The DNS server has a host name, domain name of the email address, etc. in association with the IP address information.

Communication is impossible if the other party is described by host name, domain name, etc. when the computer or the scanner performs IP communication.

Queries the DNS server for that information and gets the IP address of the other party. This process is called name resolution.

Therefore, the devices such as computers and scanners can communicate using the IP address.

Name resolution is necessary for the scanner to communicate using the email function or Internet connection function.

When you use those functions, make the DNS server settings.

When you assign the scanner's IP address by using the DHCP function of the DHCP server or router, it is automatically set.

The proxy server is placed at the gateway between the network and the Internet, and it communicates to the computer, scanner, and Internet (opposite server) on behalf of each of them. The opposite server communicates only to the proxy server. Therefore, scanner information such as the IP address and port number cannot be read and increased security is expected.

When you connect to the Internet via a proxy server, configure the proxy server on the scanner.

Connecting to the Network Using a Static IP Address

Selecting a static IP address using the software installer.

1. Insert the software disc into the computer, and then follow the on-screen instructions.

Note:

When the **Select Your Operation** screen is displayed, select the operation you want to perform. Select **Set up Scanner connection again** (for new network router or changing USB to network, etc.) and click **Next**.

2. On the **Select Your Connection Method** screen, select **Advanced configuration**, enter the static IP address, and then follow the on-screen instructions.

Introduction of Product Security Features

This section introduces the security function of the Epson Devices.

Feature name	Feature type	What to set	What to prevent
Setup for the administrator password	Locks the system settings, such as connection setup for network or USB.	An administrator sets a password to the device. You can set or change from both Web Config and the scanner's control panel.	Prevent from illegally reading and changing the information stored in the device such as ID, password, network settings, and so on. Also, reduce a wide range of security risks such as leakage of information for the network environment or security policy.
Setup for external interface	Controls the interface that connects to the device.	Enable or disable USB connection with the computer.	USB connection of computer: Prevents unauthorized use of the device by prohibiting scanning without going through the network.

Related Information

- ➔ [“Configuring the Administrator Password” on page 212](#)
- ➔ [“Disabling the External Interface” on page 217](#)

Administrator Settings

Configuring the Administrator Password

When you set the administrator password, you can prevent the users from changing system management settings. You can set and change the administrator password using either Web Config, the scanner's control panel, or Epson Device Admin. When using Epson Device Admin, see the Epson Device Admin guide or help.

Related Information

- ➔ [“Running Web Config on a Web Browser” on page 23](#)
- ➔ [“Software for Managing Devices on the Network \(Epson Device Admin\)” on page 25](#)

Configuring the Administrator Password from the Control Panel

You can set the administrator password from the scanner's control panel.

1. Select **Settings** on the scanner's control panel.
2. Select **System Administration > Admin Settings**.
3. Select **Admin Password > Register**.
4. Enter the new password.
5. Enter the password again.

Note:

*You can change or delete the administrator password when you select **Change** or **Reset** on the **Admin Password** screen and enter the administrator password.*

Configuring the Administrator Password from a Computer

You can set the administrator password using Web Config.

1. Access Web Config and select the **Product Security** tab > **Change Administrator Password**.
2. Enter a password to **New Password** and **Confirm New Password**. Enter the user name, if necessary.
If you want to change the password to new one, enter a current password.
3. Select **OK**.

Note:

To set or change the locked menu items, click **Administrator Login**, and then enter the administrator password.

To delete the administrator password, click **Product Security** tab > **Delete Administrator Password**, and then enter the administrator password.

Related Information

➔ [“Running Web Config on a Web Browser” on page 23](#)

Controlling the Panel Operation

If you set the administrator password and enable the Lock Setting, you can lock the items related to the scanner's system settings so that users cannot change them.

Enabling the Lock Setting

Enable the Lock Setting for the scanner where the password is set.

Specify an administrator's password first.

Enabling the Lock Setting from a Computer

1. Access Web Config and click the **Administrator Login**.
2. Enter the user name and password, and then click **OK**.
3. Select the **Device Management** tab > **Control Panel**.
4. On the **Panel Lock**, select **ON**.
5. Click **OK**.
6. Select **Settings** > **Network Status** on the scanner's control panel, and then check that the password is required.

Related Information

➔ [“Running Web Config on a Web Browser” on page 23](#)

Lock Setting Items for Control Panel Menu

This is a list of the Lock Setting items in the menu on the control panel.

Device Information menu	Panel Lock
Serial Number	-
Current Version	-
Total Number of Scans	-
Number of 1-Sided Scans	-
Number of 2-Sided Scans	-
Number of Scans of Carrier Sheet	-
Number of Scans After Replacing Roller	✓
Number of Scans After Regular Cleaning	✓

Scanner Maintenance menu	Panel Lock
Roller Cleaning	-
Roller Replacement	-
Reset Counter	✓
How to Replace	-
Regular Cleaning	-
Reset Counter	✓
How to Clean	-
Glass Cleaning	-

Settings menu		Panel Lock
Basic Settings		-
	LCD Brightness	-
	Sleep Timer	✓
	Power Off Timer	✓
	Date/Time Settings	✓
	Keyboard	-
	Language	✓
	Start-up Screen	✓
	Operation Time Out	✓
	PC Connection via USB	✓
	Direct power on	✓
Scanner Settings		-
	Slow	-
	DFDS Function	-
	Double Feed Stop Timing	✓
	Paper Protection	✓
	Detect Glass Dirt	✓
	Ultrasonic Double Feed Detection	✓
	Automatic Feeding Mode Timeout	✓
Document Capture Pro		✓
	Operation Mode	✓
System Administration		✓
	Admin Settings	✓
	Password Encryption	✓
	Customer Research	✓
	Restore	✓
	WSD Settings	✓
Roller Replacement Alert Setting		✓
	Count Alert Setting	✓
Regular Cleaning Alert Settings		✓

Settings menu		Panel Lock
	Warning Alert Setting	✓
	Count Alert Setting	✓
Network Status		✓
	Connection	✓
	Device Name	✓
	IP Address	✓
	Subnet Mask	✓
	Default Gateway	✓
	MAC Address	✓

✓ = To be locked.

- = Not to be locked.

Logging on to the Scanner as an Administrator

If the administrator password is set to the scanner, you need to log on as an administrator to operate the locked menu items on Web Config.

Enter the password to operate the locked menu items on the control panel.

Logging on to the Scanner from a Computer

When you log in to Web Config as an administrator, you can operate items that are set in the Lock Setting.

1. Enter the scanner's IP address into a browser to run Web Config.
2. Click **Administrator Login**.
3. Enter the user name and administrator password in **User Name** and **Current password**.
4. Click **OK**.

The locked items and **Administrator Logout** are displayed when being authenticated.

Click **Administrator Logout** to log off.

Note:

When you select **ON** for the **Device Management** tab > **Control Panel** > **Operation Timeout**, you log off automatically after a specific length of time if there is no activity on the control panel.

Related Information

➔ [“Running Web Config on a Web Browser” on page 23](#)

Disabling the External Interface

You can disable the interface that is used to connect the device to the scanner. Make the restriction settings to restrict scanning other than via network.

Note:

You can also make the restriction settings on the scanner's control panel.

PC Connection via USB : Settings > Basic Settings > PC Connection via USB

1. Access Web Config and select the **Product Security** tab > **External Interface**.
2. Select **Disable** on the functions you want to set.
Select **Enable** when you want to cancel controlling.
PC Connection via USB
You can restrict the usage of the USB connection from the computer. If you want to restrict it, select **Disable**.
3. Click **OK**.
4. Check that the disabled port cannot be used.
PC Connection via USB
If the driver was installed on the computer
Connect the scanner to the computer using a USB cable, and then confirm that the scanner does not scan.
If the driver was not installed on the computer
Windows:
Open the device manager and keep it, connect the scanner to the computer using a USB cable, and then confirm that the device manager's display contents stays unchanged.
Mac OS:
Connect the scanner to the computer using a USB cable, and then confirm that you cannot add the scanner from **Printers & Scanners**.

Related Information

➔ [“Running Web Config on a Web Browser” on page 23](#)

Monitoring a Remote Scanner

Checking Information for a Remote Scanner

You can check the following information of the operating scanner from **Status** by using Web Config.

Product Status

Check the status, cloud service, product number, MAC address, etc.

Network Status

Check the information of the network connection status, IP address, DNS server, etc.

Usage Status

Check the first day of scanning, scanning count, etc.

Receiving Email Notifications When Events Occur

About Email Notifications

This is the notification function that, when events such as scanning stop and scanner error occur, send the email to the specified address.

You can register up to five destinations and set the notification settings for each destination.

To use this function, you need to set up the mail server before setting up notifications.

Related Information

➔ [“Configuring a Mail Server” on page 62](#)

Configuring Email Notification

Configure email notification by using Web Config.

1. Access Web Config and select the **Device Management** tab > **Email Notification**.

2. Set the subject of email notification.

Select the contents displayed on the subject from the two pull-down menus.

The selected contents are displayed next to **Subject**.

The same contents cannot be set on left and right.

When the number of characters in **Location** exceeds 32 bytes, characters exceeding 32 bytes are omitted.

3. Enter the email address for sending the notification email.

Use A-Z a-z 0-9 ! # \$ % & ' * + - . / = ? ^ _ { | } ~ @, and enter between 1 and 255 characters.

4. Select the language for the email notifications.

5. Select the check box on the event for which you want to receive a notification.

The number of **Notification Settings** is linked to the destination number of **Email Address Settings**.

Example :

If you want to send a notification to the email address set for number 1 in **Email Address Settings** when the admin password is changed, select the check box for column 1 on the line **Administrator password changed**.

6. Click **OK**.

Confirm that an email notification will be sent by causing an event.

Example : The administrator password has been changed.

Related Information

➔ [“Running Web Config on a Web Browser” on page 23](#)

Items for Email Notification

Items	Settings and Explanation
Administrator password changed	Notice when administrator password has been changed.
Scanner error	Notice when the scanner error has occurred.

Backing Up the Settings

You can export the setting value set from Web Config to the file. You can use it for backing up the contacts, setting values, replacing the scanner, etc.

The exported file cannot be edited because it is exported as a binary file.

Export the settings

Export the setting for the scanner.

1. Access Web Config, and then select the **Device Management** tab > **Export and Import Setting Value** > **Export**.
2. Select the settings that you want to export.
Select the settings you want to export. If you select the parent category, subcategories are also selected. However, subcategories that cause errors by duplicating within the same network (such as IP addresses and so on) cannot be selected.
3. Enter a password to encrypt the exported file.
You need the password to import the file. Leave this blank if you do not want to encrypt the file.
4. Click **Export**.



Important:

*If you want to export the scanner's network settings such as the device name and IPv6 address, select **Enable to select the individual settings of device** and select more items. Only use the selected values for the replacement scanner.*

Related Information

➔ [“Running Web Config on a Web Browser” on page 23](#)

Import the settings

Import the exported Web Config file to the scanner.



Important:

When importing values that include individual information such as a scanner name or IP address, make sure the same IP address does not exist on the same network.

1. Access Web Config, and then select the **Device Management** tab > **Export and Import Setting Value** > **Import**.
2. Select the exported file, and then enter the encrypted password.
3. Click **Next**.
4. Select the settings that you want to import, and then click **Next**.
5. Click **OK**.

The settings are applied to the scanner.

Related Information

➔ [“Running Web Config on a Web Browser” on page 23](#)

Advanced Security Settings

This section explains advanced security features.

Security Settings and Prevention of Danger

When a scanner is connected to a network, you can access it from a remote location. In addition, many people can share the scanner, which is helpful in improving operational efficiency and convenience. However, risks such as illegal access, illegal use, and tampering with data are increased. If you use the scanner in an environment where you can access the Internet, the risks are even higher.

For scanners that do not have access protection from the outside, it will be possible to read the contacts that are stored in the scanner from the Internet.

In order to avoid this risk, Epson scanners have a variety of security technologies.

Set the scanner as necessary according to the environmental conditions that have been built with the customer's environment information.

Name	Feature type	What to set	What to prevent
Control of protocol	Controls the protocols and services to be used for communication between scanners and computers, and it enables and disables features.	A protocol or service that is applied to features allowed or prohibited separately.	Reducing security risks that may occur through unintended use by preventing users from using unnecessary functions.

Name	Feature type	What to set	What to prevent
SSL/TLS communications	The communication content is encrypted with SSL/TLS communications when accessing to the Epson server on the Internet from the scanner, such as communicating to the computer via web browser and updating firmware.	Obtain a CA-signed certificate, and then import it to the scanner.	Clearing an identification of the scanner by the CA-signed certification prevents impersonation and unauthorized access. In addition, communication contents of SSL/TLS are protected, and it prevents the leakage of contents for scanning data and setup information.
IPsec/IP filtering	You can set to allow severing and cutting off of data that is from a certain client or is a particular type. Since IPsec protects the data by IP packet unit (encryption and authentication), you can safely communicate unsecured protocol.	Create a basic policy and individual policy to set the client or type of data that can access the scanner.	Protect unauthorized access, and tampering and interception of communication data to the scanner.
IEEE802.1X	Only allows authenticated users to connect to the network. Allows only a permitted user to use the scanner.	Authentication setting to the RADIUS server (authentication sever).	Protect unauthorized access and use to the scanner.

Related Information

- ➔ [“Controlling Using Protocols” on page 221](#)
- ➔ [“Using a Digital Certificate” on page 224](#)
- ➔ [“SSL/TLS Communication with the Scanner” on page 229](#)
- ➔ [“Encrypted Communication Using IPsec/IP Filtering” on page 231](#)
- ➔ [“Connecting the Scanner to an IEEE802.1X Network” on page 241](#)

Security Feature Settings

When setting IPsec/IP filtering or IEEE802.1X, it is recommended that you access Web Config using SSL/TLS to communicate settings information in order to reduce security risks such as tampering or interception.

Make sure you configure the administrator password before setting IPsec/IP filtering or IEEE802.1X.

Controlling Using Protocols

You can scan using a variety of pathways and protocols.

You can lower unintended security risks by restricting scanning from specific pathways or by controlling the available functions.

Controlling protocols

Configure the protocol settings supported by the scanner.

1. Access Web Config and then select the **Network Security** tab > **Protocol**.
2. Configure each item.
3. Click **Next**.
4. Click **OK**.

The settings are applied to the scanner.

Related Information

➔ [“Running Web Config on a Web Browser” on page 23](#)

Protocols you can Enable or Disable

Protocol	Description
Bonjour Settings	You can specify whether to use Bonjour. Bonjour is used to search for devices, scan, and so on.
SLP Settings	You can enable or disable the SLP function. SLP is used for push scanning and network searching in EpsonNet Config.
WSD Settings	You can enable or disable the WSD function. When this is enabled, you can add WSD devices, and scan from the WSD port.
LLTD Settings	You can enable or disable the LLTD function. When this is enabled, it is displayed on the Windows network map.
LLMNR Settings	You can enable or disable the LLMNR function. When this is enabled, you can use name resolution without NetBIOS even if you cannot use DNS.
SNMPv1/v2c Settings	You can specify whether or not to enable SNMPv1/v2c. This is used to set up devices, monitoring, and so on.
SNMPv3 Settings	You can specify whether or not to enable SNMPv3. This is used to set up encrypted devices, monitoring, etc.

Protocol Setting Items

Bonjour Settings

Items	Setting value and Description
Use Bonjour	Select this to search for or use devices through Bonjour.
Bonjour Name	Displays the Bonjour name.
Bonjour Service Name	Displays the Bonjour service name.
Location	Displays the Bonjour location name.

Items	Setting value and Description
Wide-Area Bonjour	Set whether to use Wide-Area Bonjour.

SLP Settings

Items	Setting value and Description
Enable SLP	Select this to enable the SLP function. This is used such as network searching in EpsonNet Config.

WSD Settings

Items	Setting value and Description
Enable WSD	Select this to enable adding devices using WSD and scan from the WSD port.
Scanning Timeout (sec)	Enter the communication timeout value for WSD scanning between 3 to 3,600 seconds.
Device Name	Displays the WSD device name.
Location	Displays the WSD location name.

LLTD Settings

Items	Setting value and Description
Enable LLTD	Select this to enable LLTD. The scanner is displayed in the Windows network map.
Device Name	Displays the LLTD device name.

LLMNR Settings

Items	Setting value and Description
Enable LLMNR	Select this to enable LLMNR. You can use name resolution without NetBIOS even if you cannot use DNS.

SNMPv1/v2c Settings

Items	Setting value and Description
Enable SNMPv1/v2c	Select to enable SNMPv1/v2c.
Access Authority	Set the access authority when SNMPv1/v2c is enabled. Select Read Only or Read/Write .
Community Name (Read Only)	Enter 0 to 32 ASCII (0x20 to 0x7E) characters.
Community Name (Read/Write)	Enter 0 to 32 ASCII (0x20 to 0x7E) characters.

SNMPv3 Settings

Items		Setting value and Description
Enable SNMPv3		SNMPv3 is enabled when the box is checked.
User Name		Enter between 1 and 32 characters using 1 byte characters.
Authentication Settings		
	Algorithm	Select an algorithm for an authentication for SNMPv3.
	Password	Enter the password for an authentication for SNMPv3. Enter between 8 and 32 characters in ASCII (0x20-0x7E). If you do not specify this, leave it blank.
	Confirm Password	Enter the password you configured for confirmation.
Encryption Settings		
	Algorithm	Select an algorithm for an encryption for SNMPv3.
	Password	Enter the password for an encryption for SNMPv3. Enter between 8 and 32 characters in ASCII (0x20-0x7E). If you do not specify this, leave it blank.
	Confirm Password	Enter the password you configured for confirmation.
Context Name		Enter within 32 characters or less in Unicode (UTF-8). If you do not specify this, leave it blank. The number of characters that can be entered varies depending on the language.

Using a Digital Certificate

About Digital Certification

CA-signed Certificate

This is a certificate signed by the CA (Certificate Authority.) You can obtain it to apply to the Certificate Authority. This certificate certifies the existence of the scanner is and used for SSL/TLS communication so that you can ensure the safety of data communication.

When it is used for SSL/TLS communication, it is used as a server certificate.

When it is set to IPsec/IP Filtering or IEEE802.1x communication, it is used as a client certificate.

CA Certificate

This is a certificate that is in chain of the CA-signed Certificate, also called the intermediate CA certificate. It is used by the web browser to validate the path of the scanner's certificate when accessing the server of the other party or Web Config.

For the CA Certificate, set when to validate the path of server certificate accessing from the scanner. For the scanner, set to certify the path of the CA-signed Certificate for SSL/TLS connection.

You can obtain the CA certificate of the scanner from the Certification Authority where the CA certificate is issued.

Also, you can obtain the CA certificate used to validate the server of the other party from the Certification Authority that issued the CA-signed Certificate of the other server.

❑ Self-signed Certificate

This is a certificate that the scanner signs and issues itself. It is also called the root certificate. Because the issuer certifies itself, it is not reliable and cannot prevent impersonation.

Use it when making the security setting and performing simple SSL/TLS communication without the CA-signed Certificate.

If you use this certificate for an SSL/TLS communication, a security alert may be displayed on a web browser because the certificate is not registered on a web browser. You can use the Self-signed Certificate only for an SSL/TLS communication.

Related Information

- ➔ [“Configuring a CA-signed Certificate” on page 225](#)
- ➔ [“Updating a Self-signed Certificate” on page 228](#)
- ➔ [“Configuring a CA Certificate” on page 229](#)

Configuring a CA-signed Certificate

Obtaining a CA-signed Certificate

To obtain a CA-signed certificate, create a CSR (Certificate Signing Request) and apply it to certificate authority. You can create a CSR using Web Config and a computer.

Follow the steps to create a CSR and obtain a CA-signed certificate using Web Config. When creating a CSR using Web Config, a certificate is the PEM/DER format.

1. Access Web Config, and then select the **Network Security** tab. Next, select **SSL/TLS > Certificate** or **IPsec/IP Filtering > Client Certificate** or **IEEE802.1X > Client Certificate**.

Whatever you choose, you can obtain the same certificate and use it in common.

2. Click **Generate** of **CSR**.

A CSR creating page is opened.

3. Enter a value for each item.

Note:

Available key length and abbreviations vary by a certificate authority. Create a request according to rules of each certificate authority.

4. Click **OK**.

A completion message is displayed.

5. Select the **Network Security** tab. Next, select **SSL/TLS > Certificate**, or **IPsec/IP Filtering > Client Certificate** or **IEEE802.1X > Client Certificate**.

6. Click one of the download buttons of **CSR** according to a specified format by each certificate authority to download a CSR to a computer.



Important:

Do not generate a CSR again. If you do so, you may not be able to import an issued CA-signed Certificate.

7. Send the CSR to a certificate authority and obtain a CA-signed Certificate.
Follow the rules of each certificate authority on sending method and form.
8. Save the issued CA-signed Certificate to a computer connected to the scanner.
Obtaining a CA-signed Certificate is complete when you save a certificate to a destination.

Related Information

➔ [“Running Web Config on a Web Browser” on page 23](#)

CSR Setting Items

Items	Settings and Explanation
Key Length	Select a key length for a CSR.
Common Name	<p>You can enter between 1 and 128 characters. If this is an IP address, it should be a static IP address. You can enter 1 to 5 IPv4 addresses, IPv6 addresses, host names, FQDNs by separating them with commas.</p> <p>The first element is stored to the common name, and other elements are stored to the alias field of the certificate subject.</p> <p>Example: Scanner's IP address : 192.0.2.123, Scanner name : EPSONA1B2C3 Common Name : EPSONA1B2C3,EPSONA1B2C3.local,192.0.2.123</p>
Organization/ Organizational Unit/ Locality/ State/Province	You can enter between 0 and 64 characters in ASCII (0x20-0x7E). You can divide distinguished names with commas.
Country	Enter a country code in two-digit number specified by ISO-3166.
Sender's Email Address	You can enter the sender's email address for the mail server setting. Enter the same email address as the Sender's Email Address for the Network tab > Email Server > Basic .

Importing a CA-signed Certificate

Import the obtained CA-signed Certificate to the scanner.

 **Important:**

- Make sure that the scanner's date and time is set correctly. Certificate may be invalid.
- If you obtain a certificate using a CSR created from Web Config, you can import a certificate one time.

1. Access Web Config and then select the **Network Security** tab. Next, select **SSL/TLS** > **Certificate**, or **IPsec/IP Filtering** > **Client Certificate** or **IEEE802.1X** > **Client Certificate**.
2. Click **Import**
A certificate importing page is opened.

- Enter a value for each item. Set **CA Certificate 1** and **CA Certificate 2** when verifying the path of the certificate on the web browser that accesses the scanner.

Depending on where you create a CSR and the file format of the certificate, required settings may vary. Enter values to required items according to the following.

- A certificate of the PEM/DER format obtained from Web Config
 - Private Key:** Do not configure because the scanner contains a private key.
 - Password:** Do not configure.
 - CA Certificate 1/CA Certificate 2:** Optional
- A certificate of the PEM/DER format obtained from a computer
 - Private Key:** You need to set.
 - Password:** Do not configure.
 - CA Certificate 1/CA Certificate 2:** Optional
- A certificate of the PKCS#12 format obtained from a computer
 - Private Key:** Do not configure.
 - Password:** Optional
 - CA Certificate 1/CA Certificate 2:** Do not configure.

- Click **OK**.

A completion message is displayed.

Note:

Click **Confirm** to verify the certificate information.

Related Information

➔ [“Running Web Config on a Web Browser” on page 23](#)

CA-signed Certificate Importing Setting Items

Items	Settings and Explanation
Server Certificate or Client Certificate	Select a certificate's format. For SSL/TLS connection, the Server Certificate is displayed. For IPsec/IP Filtering or IEEE802.1x, the Client Certificate is displayed.
Private Key	If you obtain a certificate of the PEM/DER format by using a CSR created from a computer, specify a private key file that is match a certificate.
Password	If the file format is Certificate with Private Key (PKCS#12) , enter the password for encrypting the private key that is set when you obtain the certificate.
CA Certificate 1	If your certificate's format is Certificate (PEM/DER) , import a certificate of a certificate authority that issues a CA-signed Certificate used as server certificate. Specify a file if you need.
CA Certificate 2	If your certificate's format is Certificate (PEM/DER) , import a certificate of a certificate authority that issues CA Certificate 1. Specify a file if you need.

Deleting a CA-signed Certificate

You can delete an imported certificate when the certificate has expired or when an encrypted connection is no longer necessary.



Important:

If you obtain a certificate using a CSR created from Web Config, you cannot import a deleted certificate again. In this case, create a CSR and obtain a certificate again.

1. Access Web Config, and then select the **Network Security** tab. Next, select **SSL/TLS > Certificate** or **IPsec/IP Filtering > Client Certificate** or **IEEE802.1X > Client Certificate**.
2. Click **Delete**.
3. Confirm that you want to delete the certificate in the message displayed.

Related Information

➔ [“Running Web Config on a Web Browser” on page 23](#)

Updating a Self-signed Certificate

Because the Self-signed Certificate is issued by the scanner, you can update it when it has expired or when the content described changes.

1. Access Web Config and select the **Network Security** tab > **SSL/TLS > Certificate**.
2. Click **Update**.
3. Enter **Common Name**.

You can enter up to 5 IPv4 addresses, IPv6 addresses, host names, FQDNs between 1 to 128 characters and separating them with commas. The first parameter is stored to the common name, and the others are stored to the alias field for the subject of the certificate.

Example:

Scanner's IP address : 192.0.2.123, Scanner name : EPSONA1B2C3

Common name : EPSONA1B2C3,EPSONA1B2C3.local,192.0.2.123

4. Specify a validity period for the certificate.
5. Click **Next**.
6. Click **OK**.

A confirmation message is displayed.

The scanner is updated.

Note:

You can check the certificate information from **Network Security** tab > **SSL/TLS > Certificate > Self-signed Certificate** and click **Confirm**.

Related Information

➔ [“Running Web Config on a Web Browser” on page 23](#)

Configuring a CA Certificate

When you set the CA Certificate, you can validate the path to the CA certificate of the server that the scanner accesses. This can prevent impersonation.

You can obtain the CA Certificate from the Certification Authority where the CA-signed Certificate is issued.

Importing a CA Certificate

Import the CA Certificate to the scanner.

1. Access Web Config and then select the **Network Security** tab > **CA Certificate**.
2. Click **Import**.
3. Specify the CA Certificate you want to import.
4. Click **OK**.

When importing is complete, you are returned to the **CA Certificate** screen, and the imported CA Certificate is displayed.

Related Information

➔ [“Running Web Config on a Web Browser” on page 23](#)

Deleting a CA Certificate

You can delete the imported CA Certificate.

1. Access Web Config and then select the **Network Security** tab > **CA Certificate**.
2. Click **Delete** next to the CA Certificate that you want to delete.
3. Confirm that you want to delete the certificate in the message displayed.
4. Click **Reboot Network**, and then check that the deleted CA Certificate is not listed on the updated screen.

Related Information

➔ [“Running Web Config on a Web Browser” on page 23](#)

SSL/TLS Communication with the Scanner

When the server certificate is set using SSL/TLS (Secure Sockets Layer/Transport Layer Security) communication to the scanner, you can encrypt the communication path between computers. Do this if you want to prevent remote and unauthorized access.

Configuring Basic SSL/TLS Settings

If the scanner supports the HTTPS server feature, you can use an SSL/TLS communication to encrypt communications. You can configure and manage the scanner using Web Config while ensuring security.

Configure encryption strength and redirect feature.

1. Access Web Config and select the **Network Security** tab > **SSL/TLS** > **Basic**.
2. Select a value for each item.
 - Encryption Strength
Select the level of encryption strength.
 - Redirect HTTP to HTTPS
Redirect to HTTPS when HTTP is accessed.
3. Click **Next**.
A confirmation message is displayed.
4. Click **OK**.
The scanner is updated.

Related Information

➔ [“Running Web Config on a Web Browser” on page 23](#)

Configuring a Server Certificate for the Scanner

1. Access Web Config and select the **Network Security** tab > **SSL/TLS** > **Certificate**.
2. Specify a certificate to use on **Server Certificate**.
 - Self-signed Certificate
A self-signed certificate has been generated by the scanner. If you do not obtain a CA-signed certificate, select this.
 - CA-signed Certificate
If you obtain and import a CA-signed certificate in advance, you can specify this.
3. Click **Next**.
A confirmation message is displayed.
4. Click **OK**.
The scanner is updated.

Related Information

- ➔ [“Running Web Config on a Web Browser” on page 23](#)
- ➔ [“Configuring a CA-signed Certificate” on page 225](#)
- ➔ [“Configuring a CA Certificate” on page 229](#)

Encrypted Communication Using IPsec/IP Filtering

About IPsec/IP Filtering

You can filter traffic based on IP addresses, services, and port by using IPsec/IP Filtering function. By combining of the filtering, you can configure the scanner to accept or block specified clients and specified data. Additionally, you can improve security level by using an IPsec.

Note:

Computers that run Windows Vista or later or Windows Server 2008 or later support IPsec.

Configuring Default Policy

To filter traffic, configure the default policy. The default policy applies to every user or group connecting to the scanner. For more fine-grained control over users and groups of users, configure group policies.

1. Access Web Config and then select the **Network Security** tab > **IPsec/IP Filtering** > **Basic**.
2. Enter a value for each item.
3. Click **Next**.
A confirmation message is displayed.
4. Click **OK**.
The scanner is updated.

Related Information

➔ [“Running Web Config on a Web Browser” on page 23](#)

Default Policy Setting Items

Default Policy

Items	Settings and Explanation
IPsec/IP Filtering	You can enable or disable an IPsec/IP Filtering feature.

Access Control

Configure a control method for traffic of IP packets.

Items	Settings and Explanation
Permit Access	Select this to permit configured IP packets to pass through.
Refuse Access	Select this to refuse configured IP packets to pass through.
IPsec	Select this to permit configured IPsec packets to pass through.

IKE Version

Select **IKEv1** or **IKEv2** for **IKE Version**. Select one of them according to the device that the scanner is connected to.

IKEv1

The following items are displayed when you select **IKEv1** for **IKE Version**.

Items	Settings and Explanation
Authentication Method	To select Certificate , you need to obtain and import a CA-signed certificate in advance.
Pre-Shared Key	If you select Pre-Shared Key for Authentication Method , enter a pre-shared key between 1 and 127 characters.
Confirm Pre-Shared Key	Enter the key you configured for confirmation.

IKEv2

The following items are displayed when you select **IKEv2** for **IKE Version**.

Items	Settings and Explanation	
Local	Authentication Method	To select Certificate , you need to obtain and import a CA-signed certificate in advance.
	ID Type	If you select Pre-Shared Key for Authentication Method , select the type of ID for the scanner.
	ID	Enter the scanner's ID that matches the type of ID. You cannot use "@", "#", and "=" for the first character. Distinguished Name : Enter 1 to 255 1-byte ASCII (0x20 to 0x7E) characters. You need to include "=". IP Address : Enter IPv4 or IPv6 format. FQDN : Enter a combination of between 1 and 255 characters using A-Z, a-z, 0-9, "-", and period (.). Email Address : Enter 1 to 255 1-byte ASCII (0x20 to 0x7E) characters. You need to include "@". Key ID : Enter 1 to 255 1-byte ASCII (0x20 to 0x7E) characters.
	Pre-Shared Key	If you select Pre-Shared Key for Authentication Method , enter a pre-shared key between 1 and 127 characters.
	Confirm Pre-Shared Key	Enter the key you configured for confirmation.

Items		Settings and Explanation
Remote	Authentication Method	To select Certificate , you need to obtain and import a CA-signed certificate in advance.
	ID Type	If you select Pre-Shared Key for Authentication Method , select the type of ID for the device that you want to authenticate.
	ID	Enter the scanner's ID that matches to the type of ID. You cannot use "@", "#", and "=" for the first character. Distinguished Name : Enter 1 to 255 1-byte ASCII (0x20 to 0x7E) characters. You need to include "=". IP Address : Enter IPv4 or IPv6 format. FQDN : Enter a combination of between 1 and 255 characters using A-Z, a-z, 0-9, "-", and period (.). Email Address : Enter 1 to 255 1-byte ASCII (0x20 to 0x7E) characters. You need to include "@". Key ID : Enter 1 to 255 1-byte ASCII (0x20 to 0x7E) characters.
	Pre-Shared Key	If you select Pre-Shared Key for Authentication Method , enter a pre-shared key between 1 and 127 characters.
	Confirm Pre-Shared Key	Enter the key you configured for confirmation.

Encapsulation

If you select **IPsec** for **Access Control**, you need to configure an encapsulation mode.

Items	Settings and Explanation
Transport Mode	If you only use the scanner on the same LAN, select this. IP packets of layer 4 or later are encrypted.
Tunnel Mode	If you use the scanner on the Internet-capable network such as IPsec-VPN, select this option. The header and data of the IP packets are encrypted. Remote Gateway(Tunnel Mode) : If you select Tunnel Mode for Encapsulation , enter a gateway address between 1 and 39 characters.

Security Protocol

If you select **IPsec** for **Access Control**, select an option.

Items	Settings and Explanation
ESP	Select this to ensure the integrity of an authentication and data, and encrypt data.
AH	Select this to ensure the integrity of an authentication and data. Even if encrypting data is prohibited, you can use IPsec.

❑ Algorithm Settings

It is recommended that you select **Any** for all settings or select an item other than **Any** for each setting. If you select **Any** for some of the settings and select an item other than **Any** for the other settings, the device may not communicate depending on the other device that you want to authenticate.

Items		Settings and Explanation
IKE	Encryption	Select the encryption algorithm for IKE. The items vary depending on the version of IKE.
	Authentication	Select the authentication algorithm for IKE.
	Key Exchange	Select the key exchange algorithm for IKE. The items vary depending on the version of IKE.
ESP	Encryption	Select the encryption algorithm for ESP. This is available when ESP is selected for Security Protocol .
	Authentication	Select the authentication algorithm for ESP. This is available when ESP is selected for Security Protocol .
AH	Authentication	Select the encryption algorithm for AH. This is available when AH is selected for Security Protocol .

Configuring Group Policy

A group policy is one or more rules applied to a user or user group. The scanner controls IP packets that match with configured policies. IP packets are authenticated in the order of a group policy 1 to 10 then a default policy.

1. Access Web Config and then select the **Network Security** tab > **IPsec/IP Filtering** > **Basic**.
2. Click a numbered tab you want to configure.
3. Enter a value for each item.
4. Click **Next**.
A confirmation message is displayed.
5. Click **OK**.
The scanner is updated.

Group Policy Setting Items

Items	Settings and Explanation
Enable this Group Policy	You can enable or disable a group policy.

Access Control

Configure a control method for traffic of IP packets.

Items	Settings and Explanation
Permit Access	Select this to permit configured IP packets to pass through.
Refuse Access	Select this to refuse configured IP packets to pass through.
IPsec	Select this to permit configured IPsec packets to pass through.

Local Address (Scanner)

Select an IPv4 address or IPv6 address that matches your network environment. If an IP address is assigned automatically, you can select **Use auto-obtained IPv4 address**.

Note:

If an IPv6 address is assigned automatically, the connection may be unavailable. Configure a static IPv6 address.

Remote Address(Host)

Enter a device's IP address to control access. The IP address must be 43 characters or less. If you do not enter an IP address, all addresses are controlled.

Note:

If an IP address is assigned automatically (e.g. assigned by DHCP), the connection may be unavailable. Configure a static IP address.

Method of Choosing Port

Select a method to specify ports.

- Service Name

If you select **Service Name** for **Method of Choosing Port**, select an option.

- Transport Protocol

If you select **Port Number** for **Method of Choosing Port**, you need to configure an encapsulation mode.

Items	Settings and Explanation
Any Protocol	Select this to control all protocol types.
TCP	Select this to control data for unicast.
UDP	Select this to control data for broadcast and multicast.
ICMPv4	Select this to control ping command.

- Local Port

If you select **Port Number** for **Method of Choosing Port** and if you select **TCP** or **UDP** for **Transport Protocol**, enter port numbers to control receiving packets, separating them with commas. You can enter 10 port numbers at the maximum.

Example: 20,80,119,5220

If you do not enter a port number, all ports are controlled.

- Remote Port

If you select **Port Number** for **Method of Choosing Port** and if you select **TCP** or **UDP** for **Transport Protocol**, enter port numbers to control sending packets, separating them with commas. You can enter 10 port numbers at the maximum.

Example: 25,80,143,5220

If you do not enter a port number, all ports are controlled.

IKE Version

Select **IKEv1** or **IKEv2** for **IKE Version**. Select one of them according to the device that the scanner is connected to.

IKEv1

The following items are displayed when you select **IKEv1** for **IKE Version**.

Items	Settings and Explanation
Authentication Method	If you select IPsec for Access Control , select an option. Used certificate is common with a default policy.
Pre-Shared Key	If you select Pre-Shared Key for Authentication Method , enter a pre-shared key between 1 and 127 characters.
Confirm Pre-Shared Key	Enter the key you configured for confirmation.

❑ IKEv2

The following items are displayed when you select **IKEv2** for **IKE Version**.

Items		Settings and Explanation
Local	Authentication Method	If you select IPsec for Access Control , select an option. Used certificate is common with a default policy.
	ID Type	If you select Pre-Shared Key for Authentication Method , select the type of ID for the scanner.
	ID	Enter the scanner's ID that matches the type of ID. You cannot use "@", "#", and "=" for the first character. Distinguished Name : Enter 1 to 255 1-byte ASCII (0x20 to 0x7E) characters. You need to include "=". IP Address : Enter IPv4 or IPv6 format. FQDN : Enter a combination of between 1 and 255 characters using A-Z, a-z, 0-9, "-", and period (.). Email Address : Enter 1 to 255 1-byte ASCII (0x20 to 0x7E) characters. You need to include "@". Key ID : Enter 1 to 255 1-byte ASCII (0x20 to 0x7E) characters.
	Pre-Shared Key	If you select Pre-Shared Key for Authentication Method , enter a pre-shared key between 1 and 127 characters.
	Confirm Pre-Shared Key	Enter the key you configured for confirmation.
Remote	Authentication Method	If you select IPsec for Access Control , select an option. Used certificate is common with a default policy.
	ID Type	If you select Pre-Shared Key for Authentication Method , select the type of ID for the device that you want to authenticate.
	ID	Enter the scanner's ID that matches to the type of ID. You cannot use "@", "#", and "=" for the first character. Distinguished Name : Enter 1 to 255 1-byte ASCII (0x20 to 0x7E) characters. You need to include "=". IP Address : Enter IPv4 or IPv6 format. FQDN : Enter a combination of between 1 and 255 characters using A-Z, a-z, 0-9, "-", and period (.). Email Address : Enter 1 to 255 1-byte ASCII (0x20 to 0x7E) characters. You need to include "@". Key ID : Enter 1 to 255 1-byte ASCII (0x20 to 0x7E) characters.
	Pre-Shared Key	If you select Pre-Shared Key for Authentication Method , enter a pre-shared key between 1 and 127 characters.
	Confirm Pre-Shared Key	Enter the key you configured for confirmation.

Encapsulation

If you select **IPsec** for **Access Control**, you need to configure an encapsulation mode.

Items	Settings and Explanation
Transport Mode	If you only use the scanner on the same LAN, select this. IP packets of layer 4 or later are encrypted.
Tunnel Mode	If you use the scanner on the Internet-capable network such as IPsec-VPN, select this option. The header and data of the IP packets are encrypted. Remote Gateway(Tunnel Mode): If you select Tunnel Mode for Encapsulation , enter a gateway address between 1 and 39 characters.

Security Protocol

If you select **IPsec** for **Access Control**, select an option.

Items	Settings and Explanation
ESP	Select this to ensure the integrity of an authentication and data, and encrypt data.
AH	Select this to ensure the integrity of an authentication and data. Even if encrypting data is prohibited, you can use IPsec.

Algorithm Settings

It is recommended that you select **Any** for all settings or select an item other than **Any** for each setting. If you select **Any** for some of the settings and select an item other than **Any** for the other settings, the device may not communicate depending on the other device that you want to authenticate.

Items		Settings and Explanation
IKE	Encryption	Select the encryption algorithm for IKE. The items vary depending on the version of IKE.
	Authentication	Select the authentication algorithm for IKE.
	Key Exchange	Select the key exchange algorithm for IKE. The items vary depending on the version of IKE.
ESP	Encryption	Select the encryption algorithm for ESP. This is available when ESP is selected for Security Protocol .
	Authentication	Select the authentication algorithm for ESP. This is available when ESP is selected for Security Protocol .
AH	Authentication	Select the encryption algorithm for AH. This is available when AH is selected for Security Protocol .

Combination of Local Address (Scanner) and Remote Address(Host) on Group Policy

	Setting of Local Address (Scanner)		
	IPv4	IPv6* ²	Any addresses* ³

Setting of Remote Address(Host)	IPv4* ¹	✓	–	✓
	IPv6* ^{1*2}	–	✓	✓
	Blank	✓	✓	✓

*1If **IPsec** is selected for **Access Control**, you cannot specify a prefix length.

*2If **IPsec** is selected for **Access Control**, you can select a link-local address (fe80::) but group policy will be disabled.

*3Except IPv6 link local addresses.

Related Information

➔ [“Running Web Config on a Web Browser” on page 23](#)

References of Service Name on Group Policy

Note:

Unavailable services are displayed but cannot be selected.

Service Name	Protocol type	Local port number	Remote port number	Features controlled
Any	–	–	–	All services
ENPC	UDP	3289	Any port	Searching for a scanner from applications such as Epson Device Admin and the a scanner driver
SNMP	UDP	161	Any port	Acquiring and configuring of MIB from applications such as Epson Device Admin and the Epson scanner driver
WSD	TCP	Any port	5357	Controlling WSD
WS-Discovery	UDP	3702	Any port	Searching for a scanner from WSD
Network Scan	TCP	1865	Any port	Forwarding scan data from Document Capture Pro
Network Push Scan Discovery	UDP	2968	Any port	Searching for a computer from scanner
Network Push Scan	TCP	Any port	2968	Acquiring job information of push scanning from Document Capture Pro
HTTP (Local)	TCP	80	Any port	HTTP(S) server (forwarding data of Web Config and WSD)
HTTPS (Local)	TCP	443	Any port	
HTTP (Remote)	TCP	Any port	80	HTTP(S) client (firmware updating and root certificate updating)
HTTPS (Remote)	TCP	Any port	443	

Configuration Examples of IPsec/IP Filtering

Receiving IPsec packets only

This example is to configure a default policy only.

Default Policy:

- IPsec/IP Filtering: Enable**
- Access Control: IPsec**
- Authentication Method: Pre-Shared Key**
- Pre-Shared Key:** Enter up to 127 characters.

Group Policy: Do not configure.

Receiving scanning data and scanner settings

This example allows communications of scanning data and scanner configuration from specified services.

Default Policy:

- IPsec/IP Filtering: Enable**
- Access Control: Refuse Access**

Group Policy:

- Enable this Group Policy:** Check the box.
- Access Control: Permit Access**
- Remote Address(Host):** IP address of a client
- Method of Choosing Port: Service Name**
- Service Name:** Check the box of ENPC, SNMP, HTTP (Local), HTTPS (Local) and Network Scan.

Receiving access from a specified IP address only

This example allows a specified IP address to access the scanner.

Default Policy:

- IPsec/IP Filtering: Enable**
- Access Control: Refuse Access**

Group Policy:

- Enable this Group Policy:** Check the box.
- Access Control: Permit Access**
- Remote Address(Host):** IP address of an administrator's client

Note:

Regardless of policy configuration, the client will be able to access and configure the scanner.

Configuring a Certificate for IPsec/IP Filtering

Configure the Client Certificate for IPsec/IP Filtering. When you set it, you can use the certificate as an authentication method for IPsec/IP Filtering. If you want to configure the certification authority, go to **CA Certificate**.

1. Access Web Config and then select the **Network Security** tab > **IPsec/IP Filtering** > **Client Certificate**.
2. Import the certificate in **Client Certificate**.

If you have already imported a certificate published by a Certification Authority, you can copy the certificate and use it in IPsec/IP Filtering. To copy, select the certificate from **Copy From**, and then click **Copy**.

Related Information

- ➔ [“Running Web Config on a Web Browser” on page 23](#)
- ➔ [“Configuring a CA-signed Certificate” on page 225](#)
- ➔ [“Configuring a CA Certificate” on page 229](#)

Connecting the Scanner to an IEEE802.1X Network

Configuring an IEEE802.1X Network

When you set IEEE802.1X to the scanner, you can use it on the network connected to a RADIUS server, a LAN switch with authentication function, or an access point.

1. Access Web Config and then select the **Network Security** tab > **IEEE802.1X** > **Basic**.
2. Enter a value for each item.
3. Click **Next**.
A confirmation message is displayed.
4. Click **OK**.
The scanner is updated.

Related Information

- ➔ [“Running Web Config on a Web Browser” on page 23](#)

IEEE802.1X Network Setting Items

Items	Settings and Explanation
IEEE802.1X (Wired LAN)	You can enable or disable settings of the page (IEEE802.1X > Basic) for IEEE802.1X (Wired LAN).

Items	Settings and Explanation	
EAP Type	Select an option for an authentication method between the scanner and a RADIUS server.	
	EAP-TLS	You need to obtain and import a CA-signed certificate.
	PEAP-TLS	
	PEAP/MSCHAPv2	You need to configure a password.
	EAP-TTLS	
User ID	Configure an ID to use for an authentication of a RADIUS server. Enter 1 to 128 1-byte ASCII (0x20 to 0x7E) characters.	
Password	Configure a password to authenticate the scanner. Enter 1 to 128 1-byte ASCII (0x20 to 0x7E) characters. If you are using a Windows server as a RADIUS server, you can enter up to 127 characters.	
Confirm Password	Enter the password you configured for confirmation.	
Server ID	You can configure a server ID to authenticate with a specified RADIUS server. Authenticator verifies whether a server ID is contained in the subject/subjectAltName field of a server certificate that is sent from a RADIUS server or not. Enter 0 to 128 1-byte ASCII (0x20 to 0x7E) characters.	
Certificate Validation	You can set certificate validation regardless of the authentication method. Import the certificate in CA Certificate .	
Anonymous Name	If you select PEAP-TLS or PEAP/MSCHAPv2 for EAP Type , you can configure an anonymous name instead of a user ID for a phase 1 of a PEAP authentication. Enter 0 to 128 1-byte ASCII (0x20 to 0x7E) characters.	
Encryption Strength	You can select one of the followings.	
	High	AES256/3DES
	Middle	AES256/3DES/AES128/RC4

Configuring a Certificate for IEEE802.1X

Configure the Client Certificate for IEEE802.1X. When you set it, you can use **EAP-TLS** and **PEAP-TLS** as an authentication method of IEEE802.1x. If you want to configure the certification authority certificate, go to **CA Certificate**.

1. Access Web Config and then select the **Network Security** tab > **IEEE802.1X** > **Client Certificate**.
2. Enter a certificate in the **Client Certificate**.

If you have already imported a certificate published by a Certification Authority, you can copy the certificate and use it in IEEE802.1X. To copy, select the certificate from **Copy From**, and then click **Copy**.

Related Information

➡ [“Running Web Config on a Web Browser” on page 23](#)

Solving Problems for Advanced Security

Restoring the Security Settings

When you establish a highly secure environment such as IPsec/IP Filtering, you may not be able to communicate with devices because of incorrect settings or trouble with the device or server. In this case, restore the security settings in order to make settings for the device again or to allow you temporary use.

Disabling the Security Function Using the Control Panel

You can disable IPsec/IP Filtering using Web Config.

1. Access Web Config and select the **Network Security** tab > **IPsec/IP Filtering** > **Basic**.
2. Disable the **IPsec/IP Filtering**.

Problems Using Network Security Features

Forgot a Pre-shared Key

Re-configure a pre-shared key.

To change the key, access Web Config and select the **Network Security** tab > **IPsec/IP Filtering** > **Basic** > **Default Policy** or **Group Policy**.

When you change the pre-shared key, configure the pre-shared key for computers.

Related Information

- ➔ [“Running Web Config on a Web Browser” on page 23](#)
- ➔ [“Encrypted Communication Using IPsec/IP Filtering” on page 231](#)

Cannot Communicate with IPsec Communication

Specify the algorithm that the scanner or the computer does not support.

The scanner supports the following algorithms. Check the settings of the computer.

Security Methods	Algorithms
IKE encryption algorithm	AES-CBC-128, AES-CBC-192, AES-CBC-256, AES-GCM-128*, AES-GCM-192*, AES-GCM-256*, 3DES
IKE authentication algorithm	SHA-1, SHA-256, SHA-384, SHA-512, MD5
IKE key exchange algorithm	DH Group1, DH Group2, DH Group5, DH Group14, DH Group15, DH Group16, DH Group17, DH Group18, DH Group19, DH Group20, DH Group21, DH Group22, DH Group23, DH Group24, DH Group25, DH Group26, DH Group27*, DH Group28*, DH Group29*, DH Group30*

Security Methods	Algorithms
ESP encryption algorithm	AES-CBC-128, AES-CBC-192, AES-CBC-256, AES-GCM-128, AES-GCM-192, AES-GCM-256, 3DES
ESP authentication algorithm	SHA-1, SHA-256, SHA-384, SHA-512, MD5
AH authentication algorithm	SHA-1, SHA-256, SHA-384, SHA-512, MD5

*available for IKEv2 only

Related Information

➔ [“Encrypted Communication Using IPsec/IP Filtering” on page 231](#)

Cannot Communicate Suddenly

The IP address of the scanner has been changed or cannot be used.

When the IP address registered to the local address on Group Policy has been changed or cannot be used, IPsec communication cannot be performed. Disable IPsec using the scanner's control panel.

If the DHCP is out of date, rebooting or the IPv6 address is out of date or has not been obtained, then the IP address registered for the scanner's Web Config (**Network Security** tab > **IPsec/IP Filtering** > **Basic** > **Group Policy** > **Local Address (Scanner)**) may not be found.

Use a static IP address.

The IP address of the computer has been changed or cannot be used.

When the IP address registered to the remote address on Group Policy has been changed or cannot be used, IPsec communication cannot be performed.

Disable IPsec using the scanner's control panel.

If the DHCP is out of date, rebooting or the IPv6 address is out of date or has not been obtained, then the IP address registered for the scanner's Web Config (**Network Security** tab > **IPsec/IP Filtering** > **Basic** > **Group Policy** > **Remote Address(Host)**) may not be found.

Use a static IP address.

Related Information

➔ [“Running Web Config on a Web Browser” on page 23](#)

➔ [“Encrypted Communication Using IPsec/IP Filtering” on page 231](#)

Cannot Connect After Configuring IPsec/IP Filtering

The settings of IPsec/IP Filtering are incorrect.

Connect the scanner and computer and make the IPsec/IP Filtering settings again.

Related Information

➔ [“Encrypted Communication Using IPsec/IP Filtering” on page 231](#)

Cannot Access the Scanner after Configuring IEEE802.1X

The settings of IEEE802.1X are incorrect.

Connect the scanner and a computer, and then configure IEEE802.1X again.

Related Information

➔ [“Configuring an IEEE802.1X Network” on page 241](#)

Problems on Using a Digital Certificate

Cannot Import a CA-signed Certificate

CA-signed Certificate and the information on the CSR do not match.

If the CA-signed Certificate and CSR do not have the same information, the CSR cannot be imported. Check the following:

- Are you trying to import the certificate to a device that does not have the same information?
Check the information of the CSR and then import the certificate to a device that has the same information.
- Did you overwrite the CSR saved into the scanner after sending the CSR to a certificate authority?
Obtain the CA-signed certificate again with the CSR.

CA-signed Certificate is more than 5KB.

You cannot import a CA-signed Certificate that is more than 5KB.

The password for importing the certificate is incorrect.

Enter the correct password. If you forget the password, you cannot import the certificate. Re-obtain the CA-signed Certificate.

Related Information

➔ [“Importing a CA-signed Certificate” on page 226](#)

Cannot Update a Self-Signed Certificate

The Common Name has not been entered.

Common Name must be entered.

Unsupported characters have been entered to Common Name.

Enter between 1 and 128 characters of either IPv4, IPv6, host name, or FQDN format in ASCII (0x20-0x7E).

A comma or space is included in the common name.

If a comma is entered, the Common Name is divided at that point. If only a space is entered before or after a comma, an error occurs.

Related Information

➔ [“Updating a Self-signed Certificate” on page 228](#)

Cannot Create a CSR

The Common Name has not been entered.

The **Common Name** must be entered.

Unsupported characters have been entered to Common Name, Organization, Organizational Unit, Locality, and State/Province.

Enter characters of either IPv4, IPv6, host name, or FQDN format in ASCII (0x20-0x7E).

A comma or space is included in the Common Name.

If a comma is entered, the **Common Name** is divided at that point. If only a space is entered before or after a comma, an error occurs.

Related Information

➔ [“Obtaining a CA-signed Certificate” on page 225](#)

Warning Relating to a Digital Certificate Appears

Messages	Cause/What to do
Enter a Server Certificate.	<p>Cause: You have not selected a file to import.</p> <p>What to do: Select a file and click Import.</p>
CA Certificate 1 is not entered.	<p>Cause: CA certificate 1 is not entered and only CA certificate 2 is entered.</p> <p>What to do: Import CA certificate 1 first.</p>
Invalid value below.	<p>Cause: Unsupported characters are contained in the file path and/or password.</p> <p>What to do: Make sure that the characters are entered correctly for the item.</p>
Invalid date and time.	<p>Cause: Date and time for the scanner have not been set.</p> <p>What to do: Set date and time using Web Config or EpsonNet Config.</p>

Messages	Cause/What to do
Invalid password.	<p>Cause: The password set for CA certificate and entered password do not match.</p> <p>What to do: Enter the correct password.</p>
Invalid file.	<p>Cause: You are not importing a certificate file in X509 format.</p> <p>What to do: Make sure that you are selecting the correct certificate sent by a trusted certificate authority.</p>
	<p>Cause: The file you have imported is too large. The maximum file size is 5KB.</p> <p>What to do: If you select the correct file, the certificate might be corrupted or fabricated.</p>
	<p>Cause: The chain contained in the certificate is invalid.</p> <p>What to do: For more information on the certificate, see the website of the certificate authority.</p>
Cannot use the Server Certificates that include more than three CA certificates.	<p>Cause: The certificate file in PKCS#12 format contains more than 3 CA certificates.</p> <p>What to do: Import each certificate as converting from PKCS#12 format to PEM format, or import the certificate file in PKCS#12 format that contains up to 2 CA certificates.</p>
The certificate has expired. Check if the certificate is valid, or check the date and time on the product.	<p>Cause: The certificate is out of date.</p> <p>What to do:</p> <ul style="list-style-type: none"> <input type="checkbox"/> If the certificate is out of date, obtain and import the new certificate. <input type="checkbox"/> If the certificate is not out of date, make sure the scanner's date and time are set correctly.

Messages	Cause/What to do
Private key is required.	<p>Cause: There is no paired private key with the certificate.</p> <p>What to do:</p> <ul style="list-style-type: none"> <input type="checkbox"/> If the certificate is the PEM/DER format and it is obtained from a CSR using a computer, specify the private key file. <input type="checkbox"/> If the certificate is the PKCS#12 format and it is obtained from a CSR using a computer, create a file that contains the private key. <hr/> <p>Cause: You have re-imported the PEM/DER certificate obtained from a CSR using Web Config.</p> <p>What to do: If the certificate is the PEM/DER format and it is obtained from a CSR using Web Config, you can only import it once.</p>
Setup failed.	<p>Cause: Cannot finish the configuration because the communication between the scanner and computer failed or the file cannot be read by some errors.</p> <p>What to do: After checking the specified file and communication, import the file again.</p>

Related Information

➔ [“About Digital Certification” on page 224](#)

Delete a CA-signed Certificate by Mistake

There is no backup file for the CA-signed certificate.

If you have the backup file, import the certificate again.

If you obtain a certificate using a CSR created from Web Config, you cannot import a deleted certificate again. Create a CSR and obtain a new certificate.

Related Information

➔ [“Importing a CA-signed Certificate” on page 226](#)

➔ [“Deleting a CA-signed Certificate” on page 228](#)

Technical Specifications

General Scanner Specifications.	250
Network Specifications.	251
Using Port for the Scanner.	251
Dimensions and Weight Specifications.	252
Electrical Specifications.	253
Environmental Specifications.	254
System Requirements.	254

General Scanner Specifications

Note:

Specifications are subject to change without notice.

Scanner type	Sheet Feed, one pass duplex color scanner
Photoelectric device	CIS
Effective pixels	5,100×9,300 at 600 dpi 2,550×64,500 at 300 dpi
Light source	RGB LED
Scanning resolution	600 dpi (main scan) 600 dpi (sub scan)
Output resolution	50 to 1200 dpi (in 1 dpi increments) *
Document Size	Max: 215.9×6,096 mm (8.5×240 inches) Min: 50.8×50.8 mm (2×2 inches)
Paper input	Face-down loading
Paper output	Face-down ejection
Paper capacity	100 sheets of paper at 80 g/m ²
Color Depth	<p>Color</p> <ul style="list-style-type: none"> <input type="checkbox"/> 30 bits per pixel internal (10 bits per pixel per color internal) <input type="checkbox"/> 24 bits per pixel external (8 bits per pixel per color external) <p>Grayscale</p> <ul style="list-style-type: none"> <input type="checkbox"/> 10 bits per pixel internal <input type="checkbox"/> 8 bits per pixel external <p>Black and white</p> <ul style="list-style-type: none"> <input type="checkbox"/> 10 bits per pixel internal <input type="checkbox"/> 1 bit per pixel external
Interface	Hi-Speed USB

* You can scan long paper in the following resolutions.

- 1,346.0 mm (53 in.) or less: up to 600 dpi
- 5,461.0 mm (215 in.) or less: up to 300 dpi
- 6,096.0 mm (220 in.) or less: up to 200 dpi

Network Specifications

Ethernet Specifications

Standards	IEEE802.3i (10BASE-T)* ¹ IEEE802.3u (100BASE-TX)* ¹ IEEE802.3ab (1000BASE-T)* ¹ IEEE802.3az (Energy Efficient Ethernet)* ²
Communication Mode	Auto, 10 Mbps Full duplex, 10 Mbps Half duplex, 100 Mbps Full duplex, 100 Mbps Half duplex
Connector	RJ-45

*1 Use a category 5e or higher STP (Shielded twisted pair) cable to prevent risk of radio interference.

*2 The connected device should comply with IEEE802.3az standards.

Network Functions and IPv4/IPv6

Functions	Supported
Epson Scan 2	IPv4, IPv6
Document Capture Pro/Document Capture	IPv4
Document Capture Pro Server	IPv4, IPv6

Security Protocol

IEEE802.1X*	
IPsec/IP Filtering	
SSL/TLS	HTTPS Server/Client
SMTPS (STARTTLS, SSL/TLS)	
SNMPv3	

* You need to use a connection device that complies with IEEE802.1X.

Using Port for the Scanner

The scanner uses the following port. These ports should be allowed to become available by the network administrator as necessary.

Sender (Client)	Use	Destination (Server)	Protocol	Port Number		
Scanner	File sending (When scan to network folder is used from the Scanner)	FTP server	FTP (TCP)	20		
				21		
		File server	SMB (TCP)	445		
				NetBIOS (UDP)	137	
					138	
		NetBIOS (TCP)	NetBIOS (TCP)	139		
	SMTP server			SMTP (TCP)	25	
					SMTP SSL/TLS (TCP)	465
		SMTP STARTTLS (TCP)	587			
	POP before SMTP connection (When scan to mail is used from the scanner)	POP server	POP3 (TCP)	110		
				LDAP server	LDAP (TCP)	389
						LDAP SSL/TLS (TCP)
	LDAP STARTTLS (TCP)	389				
Control WSD	Client computer	WSD (TCP)	5357			
Collecting the job information when push scanning from Document Capture Pro	Client computer	Network Push Scan	2968			
Client computer	Discover the scanner from an application such as EpsonNet Config and scanner driver.	Scanner	ENPC (UDP)	3289		
	Collect and set up the MIB information from an application such as EpsonNet Config and scanner driver.	Scanner	SNMP (UDP)	161		
	Searching WSD scanner	Scanner	WS-Discovery (UDP)	3702		
	Forwarding the scan data from Document Capture Pro	Scanner	Network Scan (TCP)	1865		
	Collecting the job information when push scanning from Document Capture Pro	Scanner	Network Push Scan	2968		

Dimensions and Weight Specifications

Dimensions *	Width: 296 mm (11.7 inches) Depth: 169 mm (6.7 inches) Height: 167 mm (6.6 inches)
--------------	--

Weight	Approx. 3.6 kg (7.9 lb)
--------	-------------------------

* Without protruding parts and the input tray.

Electrical Specifications

Scanner Electrical Specifications

Rated DC Input Power Supply Voltage	DC 24 V
Rated DC Input Current	1 A
Power Consumption	<p>USB Connection</p> <ul style="list-style-type: none"> <input type="checkbox"/> Operating: Approx. 13 W <input type="checkbox"/> Ready mode: Approx. 5.9 W <input type="checkbox"/> Sleep mode : Approx. 1.2 W <input type="checkbox"/> Power off: Approx. 0.1 W <p>Ethernet Connection</p> <ul style="list-style-type: none"> <input type="checkbox"/> Operating: Approx. 14 W <input type="checkbox"/> Ready mode: Approx. 5.9 W <input type="checkbox"/> Sleep mode : Approx. 1.5 W <input type="checkbox"/> Power off: Approx. 0.1 W

Note:

For European users, see the following Website for details on power consumption.

<http://www.epson.eu/energy-consumption>

AC Adapter Electrical Specifications

Model	A461H (AC 100-240 V) A462E (AC 220-240 V)
Rated Input Current	1 A
Rated Frequency Range	50-60 Hz
Rated Output Power Supply Voltage	DC 24 V
Rated Output Current	1 A

Note:

For European users, see the following Website for details on power consumption.

<http://www.epson.eu/energy-consumption>

Environmental Specifications

Temperature	When operating	5 to 35 °C (41 to 95 °F)
	When stored	-25 to 60 °C (-13 to 140 °F)
Humidity	When operating	15 to 80% (without condensation)
	When stored	15 to 85% (without condensation)
Operating conditions		Ordinary office or home conditions. Avoid operating the scanner in direct sunlight, near a strong light source, or in extremely dusty conditions.

System Requirements

Supported operating systems may vary depending on the application.

Windows	Windows 10 (32-bit, 64-bit) Windows 8.1 (32-bit, 64-bit) Windows 8 (32-bit, 64-bit) Windows 7 (32-bit, 64-bit)
Mac OS*1 *2	macOS Catalina macOS Mojave macOS High Sierra macOS Sierra OS X El Capitan OS X Yosemite

*1 Fast User Switching on Mac OS or later is not supported.

*2 The UNIX File System (UFS) for Mac OS is not supported.

Standards and Approvals

Standards and Approvals for European Models.	256
Standards and Approvals for U.S. Models.	256

Standards and Approvals for European Models

Product and AC adapter

The following models are CE marked and in compliance with all the applicable EU Directives. For further details, visit the following website to access the full declaration of conformities containing reference to the Directives and harmonized standards used to declare conformity.

<http://www.epson.eu/conformity>

J382A

A461H, A462E

Standards and Approvals for U.S. Models

Product

EMC	FCC Part 15 Subpart B Class B CAN ICES-3 (B)/NMB-3 (B)
-----	---

AC adapter (A461H)

Safety	UL60950-1 CAN/CSA-C22.2 No.60950-1
EMC	FCC Part 15 Subpart B Class B CAN ICES-3 (B)/NMB-3 (B)



Where to Get Help

Technical Support Web Site.	258
Contacting Epson Support.	258

Technical Support Web Site

If you need further help, visit the Epson support website shown below. Select your country or region and go to the support section of your local Epson website. The latest drivers, FAQs, manuals, or other downloadables are also available from the site.

<http://support.epson.net/>

<http://www.epson.eu/support> (Europe)

If your Epson product is not operating properly and you cannot solve the problem, contact Epson support services for assistance.

Contacting Epson Support

Before Contacting Epson

If your Epson product is not operating properly and you cannot solve the problem using the troubleshooting information in your product manuals, contact Epson support services for assistance. If Epson support for your area is not listed below, contact the dealer where you purchased your product.

Epson support will be able to help you much more quickly if you give them the following information:

- Product serial number
(The serial number label is usually on the back of the product.)
- Product model
- Product software version
(Click **About**, **Version Info**, or a similar button in the product software.)
- Brand and model of your computer
- Your computer operating system name and version
- Names and versions of the software applications you normally use with your product

Note:

Depending on the product, the dial list data for fax and/or network settings may be stored in the product's memory. Due to breakdown or repair of a product, data and/or settings may be lost. Epson shall not be responsible for the loss of any data, for backing up or recovering data and/or settings even during a warranty period. We recommend that you make your own backup data or take notes.

Help for Users in Europe

Check your Pan-European Warranty Document for information on how to contact Epson support.

Help for Users in Taiwan

Contacts for information, support, and services are:

World Wide Web

<http://www.epson.com.tw>

Information on product specifications, drivers for download, and products enquiry are available.

Epson HelpDesk

Phone: +886-2-80242008

Our HelpDesk team can help you with the following over the phone:

- Sales enquiries and product information
- Product usage questions or problems
- Enquiries on repair service and warranty

Repair service center:

<http://www.tekcare.com.tw/branchMap.page>

TekCare corporation is an authorized service center for Epson Taiwan Technology & Trading Ltd.

Help for Users in Singapore

Sources of information, support, and services available from Epson Singapore are:

World Wide Web

<http://www.epson.com.sg>

Information on product specifications, drivers for download, Frequently Asked Questions (FAQ), Sales Enquiries, and Technical Support via e-mail are available.

Epson HelpDesk

Toll Free: 800-120-5564

Our HelpDesk team can help you with the following over the phone:

- Sales enquiries and product information
- Product usage questions or problem troubleshooting
- Enquiries on repair service and warranty

Help for Users in Thailand

Contacts for information, support, and services are:

World Wide Web

<http://www.epson.co.th>

Information on product specifications, drivers for download, Frequently Asked Questions (FAQ), and e-mail are available.

Epson Call Centre

Phone: 66-2685-9899

Email: support@eth.epson.co.th

Our Call Centre team can help you with the following over the phone:

- Sales enquiries and product information
- Product usage questions or problems
- Enquiries on repair service and warranty

Help for Users in Vietnam

Contacts for information, support, and services are:

Epson Service Center

65 Truong Dinh Street, District 1, Ho Chi Minh City, Vietnam.

Phone(Ho Chi Minh City): 84-8-3823-9239, 84-8-3825-6234

29 Tue Tinh, Quan Hai Ba Trung, Hanoi City, Vietnam

Phone(Hanoi City): 84-4-3978-4785, 84-4-3978-4775

Help for Users in Indonesia

Contacts for information, support, and services are:

World Wide Web

<http://www.epson.co.id>

- Information on product specifications, drivers for download
- Frequently Asked Questions (FAQ), Sales Enquiries, questions through e-mail

Epson Hotline

Phone: +62-1500-766

Fax: +62-21-808-66-799

Our Hotline team can help you with the following over the phone or fax:

- Sales enquiries and product information
- Technical support

Epson Service Center

Province	Company Name	Address	Phone E-mail
DKI JAKARTA	ESS JAKARTA MANGGADUA	Ruko Mall Mangga Dua No. 48 Jl. Arteri Mangga Dua, Jakarta Utara - DKI JAKARTA	(+6221) 62301104 jkt-admin@epson-indonesia.co.id

Province	Company Name	Address	Phone E-mail
NORTH SUMATERA	ESC MEDAN	Jl. Bambu 2 Komplek Graha Niaga Nomor A-4, Medan - North Sumatera	(+6261) 42066090 / 42066091 mdn-adm@epson-indonesia.co.id
WEST JAWA	ESC BANDUNG	Jl. Cihampelas No. 48 A Bandung Jawa Barat 40116	(+6222) 4207033 bdg-admin@epson-indonesia.co.id
DI YOGYAKARTA	ESC YOGYAKARTA	YAP Square, Block A No. 6 Jl. C Simanjutak Yogyakarta - DIY	(+62274) 581065 ygy-admin@epson-indonesia.co.id
EAST JAWA	ESC SURABAYA	Hitech Mall Lt. 2 Block A No. 24 Jl. Kusuma Bangsa No. 116 - 118 Surabaya - JATIM	(+6231) 5355035 sby-admin@epson-indonesia.co.id
SOUTH SULAWESI	ESC MAKASSAR	Jl. Cendrawasih NO. 3A, kunjung mae, mariso, MAKASSAR - SULSEL 90125	(+62411) 8911071 mksr-admin@epson-indonesia.co.id
WEST KALIMANTAN	ESC PONTIANAK	Komp. A yani Sentra Bisnis G33, Jl. Ahmad Yani - Pontianak Kalimantan Barat	(+62561) 735507 / 767049 pontianak-admin@epson-indonesia.co.id
RIAU	ESC PEKANBARU	Jl. Tuanku Tambusai No.459A Pekanbaru Riau	(+62761) 8524695 pkb-admin@epson-indonesia.co.id
DKI JAKARTA	ESS JAKARTA SUDIRMAN	Wisma Keiai Lt. 1 Jl. Jenderal Sudirman Kav. 3 Jakarta Pusat - DKI JAKARTA 10220	(+6221) 5724335 ess@epson-indonesia.co.id
EAST JAWA	ESS SURABAYA	Ruko Surya Inti Jl. Jawa No 2-4 Kav. 29 Surabaya - Jawa Timur	(+6231) 5014949 esssby@epson-indonesia.co.id
BANTEN	ESS SERPONG	Ruko Mall WTC Matahari No. 953, Serpong-Banten	(+6221) 53167051 / 53167052 esstag@epson-indonesia.co.id
CENTRAL JAWA	ESS SEMARANG	Komplek Ruko Metro Plaza Block C20 Jl. MT Haryono No 970 Semarang - JAWA TENGAH	(+6224) 8313807 / 8417935 esssmg@epson-indonesia.co.id
EAST KALIMANTAN	ESC SAMARINDA	Jl. KH. Wahid Hasyim (M. Yamin) Kelurahan Sempaja Selatan Kecamatan Samarinda UTARA - SAMARINDA - KALTIM	(+62541) 7272904 escsmd@epson-indonesia.co.id
SOUTH SUMATERA	ESC PALEMBANG	Jl. H.M Rasyid Nawawi No. 249 Kelurahan 9 Ilir Palembang Sumatera Selatan	(+62711) 311330 escplg@epson-indonesia.co.id
EAST JAVA	ESC JEMBER	JL. Panglima Besar Sudirman Ruko no.1D Jember-Jawa Timur (Depan Balai Penelitian & Pengolahan Kakao)	(+62331) 488373 / 486468 jmr-admin@epson-indonesia.co.id
NORTH SULAWESI	ESC MANADO	Tekno Megamall Lt LG 11 TK 21, Kawasan Megamas Boulevard, Jl Piere Tendean, Manado - SULUT 95111	(+62431) 8890996 MND-ADMIN@EPSON-INDONESIA.CO.ID

For other cities not listed here, call the Hot Line: 08071137766.

Help for Users in Hong Kong

To obtain technical support as well as other after-sales services, users are welcome to contact Epson Hong Kong Limited.

Internet Home Page

<http://www.epson.com.hk>

Epson Hong Kong has established a local home page in both Chinese and English on the Internet to provide users with the following information:

- Product information
- Answers to Frequently Asked Questions (FAQs)
- Latest versions of Epson product drivers

Technical Support Hotline

You can also contact our technical staff at the following telephone and fax numbers:

Phone: 852-2827-8911

Fax: 852-2827-4383

Help for Users in Malaysia

Contacts for information, support, and services are:

World Wide Web

<http://www.epson.com.my>

- Information on product specifications, drivers for download
- Frequently Asked Questions (FAQ), Sales Enquiries, questions through e-mail

Epson Call Centre

Phone: +60 1800-8-17349

- Sales enquiries and product information
- Product usage questions or problems
- Enquiries on repair services and warranty

Head Office

Phone: 603-56288288

Fax: 603-5628 8388/603-5621 2088

Help for Users in India

Contacts for information, support, and services are:

World Wide Web

<http://www.epson.co.in>

Information on product specifications, drivers for download, and products enquiry are available.

Helpline

- Service, product information, and ordering consumables (BSNL Lines)

Toll-free number: 18004250011

Accessible 9am to 6pm, Monday through Saturday (Except public holidays)

- Service (CDMA & Mobile Users)

Toll-free number: 186030001600

Accessible 9am to 6pm, Monday through Saturday (Except public holidays)

Help for Users in the Philippines

To obtain technical support as well as other after sales services, users are welcome to contact the Epson Philippines Corporation at the telephone, fax numbers and e-mail address below:

World Wide Web

<http://www.epson.com.ph>

Information on product specifications, drivers for download, Frequently Asked Questions (FAQ), and E-mail Enquiries are available.

Epson Philippines Customer Care

Toll Free: (PLDT) 1-800-1069-37766

Toll Free: (Digital) 1-800-3-0037766

Metro Manila: (+632)441-9030

Web Site: <https://www.epson.com.ph/contact>

E-mail: customercare@epc.epson.com.ph

Accessible 9am to 6pm, Monday through Saturday (Except public holidays)

Our Customer Care team can help you with the following over the phone:

- Sales enquiries and product information
- Product usage questions or problems
- Enquiries on repair service and warranty

Epson Philippines Corporation

Trunk Line: +632-706-2609

Fax: +632-706-2663