

ES-500W II

User's Guide

Product Features

Scanner Basics

**Specifications of Originals and Placing
Originals**

Network Settings

Scanning

Maintenance

Solving Problems

Copyright

No part of this publication may be reproduced, stored in a retrieval system, or transmitted in any form or by any means, electronic, mechanical, photocopying, recording, or otherwise, without the prior written permission of Seiko Epson Corporation. No patent liability is assumed with respect to the use of the information contained herein. Neither is any liability assumed for damages resulting from the use of the information herein. The information contained herein is designed only for use with this Epson product. Epson is not responsible for any use of this information as applied to other products.

Neither Seiko Epson Corporation nor its affiliates shall be liable to the purchaser of this product or third parties for damages, losses, costs, or expenses incurred by the purchaser or third parties as a result of accident, misuse, or abuse of this product or unauthorized modifications, repairs, or alterations to this product, or (excluding the U.S.) failure to strictly comply with Seiko Epson Corporation's operating and maintenance instructions.

Seiko Epson Corporation and its affiliates shall not be liable for any damages or problems arising from the use of any options or any consumable products other than those designated as Original Epson Products or Epson Approved Products by Seiko Epson Corporation.

Seiko Epson Corporation shall not be held liable for any damage resulting from electromagnetic interference that occurs from the use of any interface cables other than those designated as Epson Approved Products by Seiko Epson Corporation.

© 2020 Seiko Epson Corporation

The contents of this manual and the specifications of this product are subject to change without notice.

Trademarks

- ❑ EPSON, EPSON EXCEED YOUR VISION, EXCEED YOUR VISION and their logos are registered trademarks or trademarks of Seiko Epson.
- ❑ Microsoft®, Windows®, and Windows Vista® are registered trademarks of Microsoft Corporation.
- ❑ Apple, macOS, and OS X are registered trademarks of Apple, Inc.
- ❑ Adobe, Adobe Reader, and Acrobat are either registered trademarks or trademarks of Adobe Systems Incorporated in the United States and/or other countries.
- ❑ Intel® is a registered trademark of Intel Corporation.
- ❑ Wi-Fi, Wi-Fi Alliance, and Wi-Fi Protected Access (WPA) are registered trademarks of the Wi-Fi Alliance. Wi-Fi Protected Setup, and WPA2 are trademarks of the Wi-Fi Alliance.
- ❑ The SuperSpeed USB Trident Logo is a registered trademark of USB Implementers Forum, Inc.
- ❑ General Notice: Other product names used herein are for identification purposes only and may be trademarks of their respective owners. Epson disclaims any and all rights in those marks.

Contents

Copyright

Trademarks

About This Manual

Introduction to the Manuals.	8
Marks and Symbols.	8
Descriptions Used in this Manual.	8
Operating System References.	8

Important Instructions

Safety Instructions.	11
Restrictions on Copying.	12

Product Features

Supports Epson Smart Panel, an App for Smart Devices.	14
Paper Protection to Reduce Damage to the Originals.	15
Notification of Dirt on the Sensor.	15
Double-Feed Detection Feature with Selectable Stop Timing.	15
High-Quality Scanning with Automatic Document Detection.	16

Scanner Basics

Part Names and Functions.	18
Buttons and Lights on the Control Panel.	20
Buttons.	20
Lights.	21
Error Indicators.	22
Information on Applications.	23
Application for Scanning from a Computer (Epson ScanSmart).	23
Application for Scanning Documents from a Smart Device (Epson Smart Panel).	24
Application for Updating Software and Firmware (EPSON Software Updater).	24
Application for Configuring Scanner Operations (Web Config).	24
Application for Setting up the Device on a Network (EpsonNet Config).	26
Software for Managing Devices on the Network (Epson Device Admin).	26

Application for Creating Driver Packages (EpsonNet SetupManager).	27
Option Items and Consumables Information.	27
Carrier Sheet Codes.	27
Roller Assembly Kit Codes.	27
Cleaning Kit Codes.	28

Specifications of Originals and Placing Originals

Specifications of Originals.	30
General Specifications for Originals being Scanned.	30
Types of Originals that Require Attention.	33
Types of Originals that Must Not be Scanned.	34
Placing Originals.	35
Standard Size Originals.	35
Long Paper.	40
Plastic Cards.	42
Laminated Cards.	46
Large Size Originals.	48
Irregular Shaped Originals.	51
Photographs.	54
Envelopes.	57
Mixture of Originals.	60

Network Settings

Network Connection Types.	64
Wi-Fi Connection.	64
AP Mode Connection.	64
Connecting the Scanner to the Network.	65
Making Wi-Fi Settings from the Control Panel.	65
Making Wi-Fi Settings by Push Button Setup (WPS).	65
Making Wi-Fi Settings by PIN Code Setup (WPS).	66
Making AP Mode Settings.	67
Checking the Scanner's IP Address.	67

Scanning

Scanning from a Computer.	69
Scanning Using Epson ScanSmart.	69
Scanning Different Sizes or Types of Originals One by One Continuously (Automatic Feeding Mode).	73
Scanning from Smart Device (Epson Smart Panel).	75

Useful Features

- Setting the Glass Surface Stain Detection Feature. 77
- Setting the Document Protection Feature. 78
- Setting the Operation When a Double-Feed is Detected. 79

Maintenance

- Cleaning Outside the Scanner. 82
- Cleaning Inside the Scanner. 82
 - Resetting the Number of Scans After Regular Cleaning. 86
- Replacing the Roller Assembly Kit. 88
 - Resetting the Number of Scans After Replacing the Rollers. 92
- Energy Saving. 94
- Transporting the Scanner. 95
- Updating Applications and Firmware. 95
 - Updating Firmware Using Web Config. 96
 - Updating Firmware without Connecting to the Internet. 96

Solving Problems

- Scanner Problems. 99
 - Scanner Lights Indicate an Error. 99
 - The Scanner Does Not Turn On. 99
- Problems Starting Scanning. 99
 - Cannot Start Scanning from Computer. 99
 - Cannot Start Scanning from Smart Device. 104
- Paper Feeding Problems. 106
 - Multiple Originals Are Fed (Double Feed). 106
 - Removing Jammed Originals from the Scanner. 107
 - The Original Jams in the Scanner Frequently. 108
 - Paper Protection Does not Work Correctly. 109
 - The Originals Get Dirty. 109
 - Scanning Speed Slows Down when Scanning Continuously. 109
 - Scanning Takes a Long Time. 109
- Scanned Image Problems. 110
 - Straight Lines Appear when Scanning from ADF. 110
 - Glass Dirt Alert Does Not Disappear. 110
 - Colors Are Uneven in the Scanned Image. 110
 - Expanding or Contracting the Scanned Image. 111
 - Offset Appears in the Background of Images. 111
 - Scanned Image or Text is Blurred. 112
 - Moiré Patterns (Web-Like Shadows) Appear. 113

- The Edge of the Original is Not Scanned when Automatically Detecting the Size of the Original. 113
- Character is not Recognized Correctly. 113
- Cannot Solve Problems in the Scanned Image. 114
- Uninstalling and Installing Applications. 115
 - Uninstalling Your Applications. 115
 - Installing Your Applications. 116

Adding or Replacing the Computer or Devices

- Connecting to a Scanner that has been Connected to the Network. 118
 - Using a Network Scanner from a Second Computer. 118
 - Using a Network Scanner from a Smart Device. 119
- Re-setting the Network Connection. 119
 - When Replacing the Wireless Router. 119
 - When Changing the Computer. 120
 - Changing the Connection Method to the Computer. 120
 - Making Wi-Fi Settings from the Control Panel. 121
- Checking the Network Connection Status. 121
 - Checking the Network Status Using Network Light. 121
 - Checking the Network of the Computer (Windows only). 121
- Disabling the Network Setting from the Control Panel. 122
- Restoring the Network Settings from the Control Panel. 123

Administrator Information

- Connecting to the Network. 125
 - Before Making Network Connection. 125
 - Connecting to the Network Using a Static IP Address. 126
- Introduction of Product Security Features. 127
- Administrator Settings. 127
 - Configuring the Administrator Password. 127
 - Logging on to the Scanner from a Computer. 128
- Monitoring a Remote Scanner. 128
 - Checking Information for a Remote Scanner. 128
 - Receiving Email Notifications When Events Occur. 129
- Backing Up the Settings. 132
 - Export the settings. 132
 - Import the settings. 133

Advanced Security Settings.	134
Security Settings and Prevention of Danger.	134
Controlling Using Protocols.	135
Using a Digital Certificate.	137
SSL/TLS Communication with the Scanner.	143
Encrypted Communication Using IPsec/IP Filtering.	144
Connecting the Scanner to an IEEE802.1X Network.	155
Solving Problems for Advanced Security.	157

Technical Specifications

General Scanner Specifications.	166
Network Specifications.	167
Wi-Fi Specifications.	167
Network Function List.	167
Security Protocol.	167
Using Port for the Scanner.	167
Dimensions and Weight Specifications.	168
Electrical Specifications.	168
Scanner Electrical Specifications.	168
AC Adapter Electrical Specifications.	169
Environmental Specifications.	169
System Requirements.	170

Standards and Approvals

Standards and Approvals for European Models.	172
Standards and Approvals for U.S. Models.	172

Where to Get Help

Technical Support Web Site.	175
Contacting Epson Support.	175
Before Contacting Epson.	175
Help for Users in Europe.	175
Help for Users in Taiwan.	175
Help for Users in Singapore.	176
Help for Users in Thailand.	176
Help for Users in Vietnam.	177
Help for Users in Indonesia.	177
Help for Users in Hong Kong.	179
Help for Users in Malaysia.	179
Help for Users in India.	180
Help for Users in the Philippines.	180

About This Manual

Introduction to the Manuals.	8
Marks and Symbols.	8
Descriptions Used in this Manual.	8
Operating System References.	8

Introduction to the Manuals

The latest versions of the following manuals are available from the Epson support website.

<http://www.epson.eu/support> (Europe)

<http://support.epson.net/> (outside Europe)

Start Here (paper manual)

Provides you with information on setting up the product and installing the application.

User's Guide (digital manual)

Provides instructions on using the product, maintenance, and solving problems.

As well as the manuals above, see the help included in the various Epson applications.

Marks and Symbols



Caution:

Instructions that must be followed carefully to avoid bodily injury.



Important:

Instructions that must be observed to avoid damage to your equipment.

Note:

Provides complementary and reference information.

Related Information

➔ Links to related sections.

Descriptions Used in this Manual

Screenshots for the applications are from Windows 10 or macOS High Sierra. The content displayed on the screens varies depending on the model and situation.

Illustrations used in this manual are for reference only. Although they may differ slightly from the actual product, the operating methods are the same.

Operating System References

Windows

In this manual, terms such as "Windows 10", "Windows 8.1", "Windows 8", and "Windows 7" refer to the following operating systems. Additionally, "Windows" is used to refer to all versions.

Microsoft® Windows® 10 operating system

- Microsoft® Windows® 8.1 operating system
- Microsoft® Windows® 8 operating system
- Microsoft® Windows® 7 operating system

Mac OS

In this manual, "Mac OS" is used to refer to macOS Catalina, macOS Mojave, macOS High Sierra, macOS Sierra, OS X El Capitan, and OS X Yosemite.



Important Instructions

Safety Instructions. 11

Restrictions on Copying. 12

Safety Instructions

Read and follow these instructions to ensure safe use of this product and options. Make sure you keep this manual for future reference. Also, be sure to follow all warnings and instructions marked on the product and options.

- ❑ Some of the symbols used on your product and options are to ensure safety and proper use of the product. Visit the following Web site to learn the meaning of the symbols.

<http://support.epson.net/symbols>

- ❑ Place the product and options on a flat, stable surface that extends beyond the base of the product and options in all directions. If you place the product and options by the wall, leave more than 10 cm between the back of the product and options and the wall.
- ❑ Place the product and options close enough to the computer for the interface cable to reach it easily. Do not place or store the product and options or the AC adapter outdoors, near excessive dirt or dust, water, heat sources, or in locations subject to shocks, vibrations, high temperature or humidity, direct sunlight, strong light sources, or rapid changes in temperature or humidity.
- ❑ Do not use with wet hands.
- ❑ Place the product and options near an electrical outlet where the adapter can be easily unplugged.
- ❑ The AC adapter cord should be placed to avoid abrasions, cuts, fraying, crimping, and kinking. Do not place objects on top of the cord and do not allow the AC adapter or the cord to be stepped on or run over. Be particularly careful to keep the cord straight at the end.
- ❑ Use only the power cord supplied with the product and do not use the cord with any other equipment. Use of other cords with this product or the use of the supplied power cord with other equipment may result in fire or electric shock.
- ❑ Use only the AC adapter that comes with your product. Using any other adapter could cause fire, electrical shock, or injury.
- ❑ The AC adapter is designed for use with the product with which it was included. Do not attempt to use it with other electronic devices unless specified.
- ❑ Use only the type of power source indicated on the AC adapter's label, and always supply power directly from a standard domestic electrical outlet with the AC adapter that meets the relevant local safety standards.
- ❑ When connecting this product and options to a computer or other device with a cable, ensure the correct orientation of the connectors. Each connector has only one correct orientation. Inserting a connector in the wrong orientation may damage both devices connected by the cable.
- ❑ Avoid using outlets on the same circuit as photocopiers or air control systems that regularly switch on and off.
- ❑ If you use an extension cord with the product, make sure the total ampere rating of the devices plugged into the extension cord does not exceed the cord's ampere rating. Also, make sure the total ampere rating of all devices plugged into the wall outlet does not exceed the wall outlet's ampere rating.
- ❑ Never disassemble, modify, or attempt to repair the AC adapter, product, or product options by yourself except as specifically explained in the product's guides.
- ❑ Do not insert objects into any opening as they may touch dangerous voltage points or short out parts. Beware of electrical shock hazards.
- ❑ If damage occurs to the plug, replace the cord set or consult a qualified electrician. If there are fuses in the plug, make sure you replace them with fuses of the correct size and rating.
- ❑ Unplug the product, options, and the AC adapter, and refer servicing to qualified service personnel under the following conditions: The AC adapter or plug is damaged; liquid has entered the product, options, or the AC adapter; the product or the AC adapter has been dropped or the case has been damaged; the product, options, or the AC adapter does not operate normally or exhibits a distinct change in performance. (Do not adjust controls that are not covered by the operating instructions.)

- Unplug the product and the AC adapter before cleaning. Clean with a damp cloth only. Do not use liquid or aerosol cleaners except as specifically explained in the product's guides.
- If you are not going to use the product for a long period, be sure to unplug the AC adapter from the electrical outlet.
- After replacing consumable parts, dispose of them correctly following the rules of your local authority. Do not disassemble them.
- Keep this product at least 22 cm away from cardiac pacemakers. Radio waves from this product may adversely affect the operation of cardiac pacemakers.
- Do not use this product inside medical facilities or near medical equipment. Radio waves from this product may adversely affect the operation of electrical medical equipment.
- Do not use this product near automatically controlled devices such as automatic doors or fire alarms. Radio waves from this product may adversely affect these devices, and could lead to accidents due to malfunction.

Restrictions on Copying

Observe the following restrictions to ensure the responsible and legal use of your product.

Copying of the following items is prohibited by law:

- Bank bills, coins, government-issued marketable securities, government bond securities, and municipal securities
- Unused postage stamps, pre-stamped postcards, and other official postal items bearing valid postage
- Government-issued revenue stamps, and securities issued according to legal procedure

Exercise caution when copying the following items:

- Private marketable securities (stock certificates, negotiable notes, checks, etc.), monthly passes, concession tickets, etc.
- Passports, driver's licenses, warrants of fitness, road passes, food stamps, tickets, etc.

Note:

Copying these items may also be prohibited by law.

Responsible use of copyrighted materials:

Products can be misused by improperly copying copyrighted materials. Unless acting on the advice of a knowledgeable attorney, be responsible and respectful by obtaining the permission of the copyright holder before copying published material.

Product Features

Supports Epson Smart Panel, an App for Smart Devices.	14
Paper Protection to Reduce Damage to the Originals.	15
Notification of Dirt on the Sensor.	15
Double-Feed Detection Feature with Selectable Stop Timing.	15
High-Quality Scanning with Automatic Document Detection.	16

Supports Epson Smart Panel, an App for Smart Devices

Epson Smart Panel, an intuitive app for operating smart devices

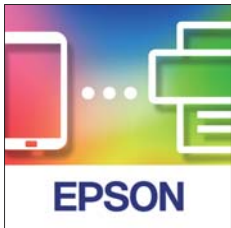

You can use the Epson Smart Panel to perform the following operations.

- You can scan from your smart device and save scanned results to your smart device.
- You can easily upload scanned data to a cloud service.
- You can easily make Wi-Fi settings by following the guidance provided.
- You can check the causes and solutions to errors from your smart device.

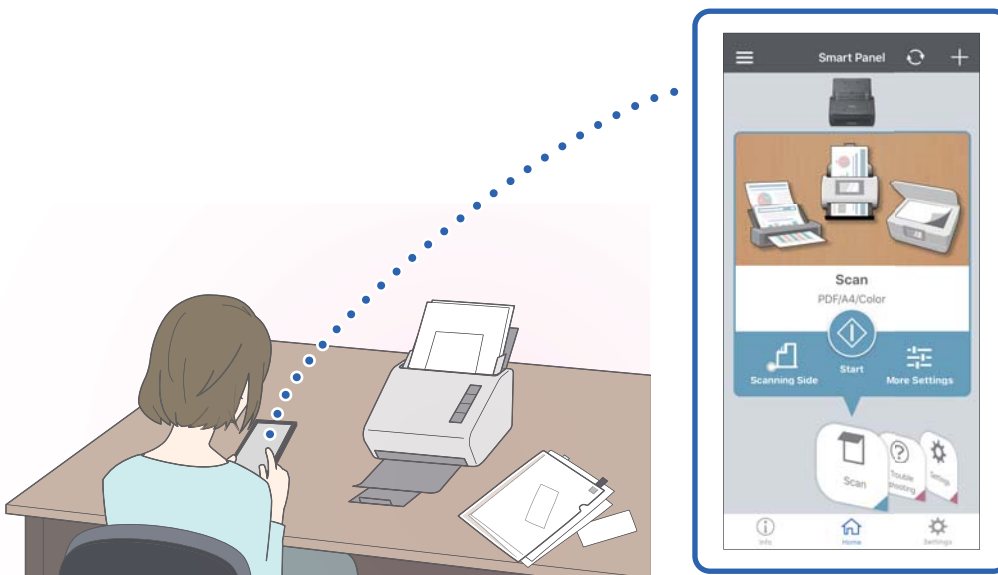

Related Information

➔ [“Application for Scanning Documents from a Smart Device \(Epson Smart Panel\)”](#) on page 24

Paper Protection to Reduce Damage to the Originals

This scanner comes with a paper protection feature. This feature reduces damage to originals by stopping scanning when it detects a feeding error, such as when scanning stapled documents by mistake.



Related Information

➔ [“Setting the Document Protection Feature” on page 78](#)

Notification of Dirt on the Sensor

This scanner can detect dirt on the scanning sensor, and notifies you that you need to clean the sensor before dirt can cause lines in the scanned images.

You can easily keep the sensor clean, and avoid a decline in image quality.

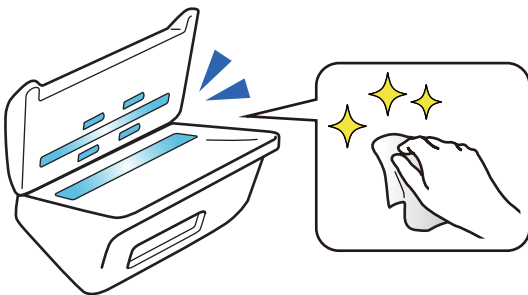

Related Information

➔ [“Setting the Glass Surface Stain Detection Feature” on page 77](#)

Double-Feed Detection Feature with Selectable Stop Timing

When multiple documents are fed during scanning, the double-feed detection feature will stop scanning. When a double-feed is detected, you can select between stopping the scan immediately or stopping after ejecting the document.

For example, when scanning slips attached to sheets of paper, selecting **After Eject** detects a double-feed and stops after ejecting the paper, but allows you to continue scanning.

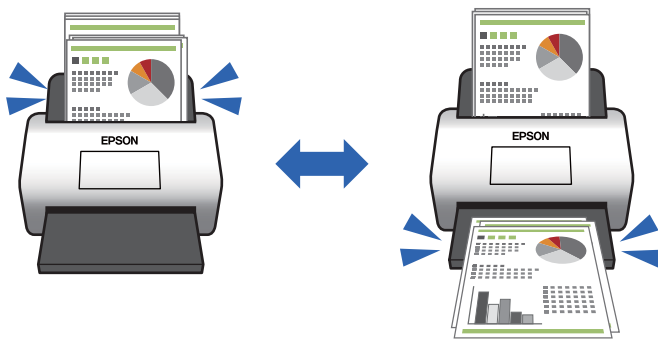

Related Information

➔ [“Setting the Operation When a Double-Feed is Detected” on page 79](#)

High-Quality Scanning with Automatic Document Detection

You can set Color/Black & White automatic detection as well as Color/Grayscale automatic detection according to the document and application being used.

When set to Color/Grayscale automatic detection, you can attain high-quality images by scanning monochrome documents that include figures and tables in grayscale.

Color/Black & White

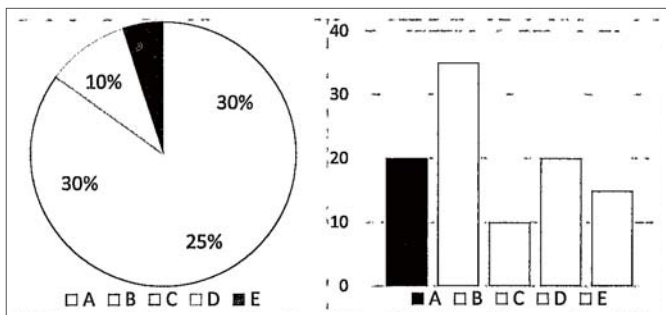

Color/Grayscale

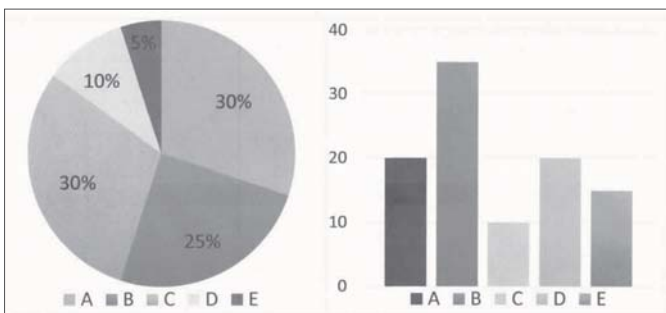

Scanner Basics

Part Names and Functions.	18
Buttons and Lights on the Control Panel.	20
Information on Applications.	23
Option Items and Consumables Information.	27

Part Names and Functions

Front

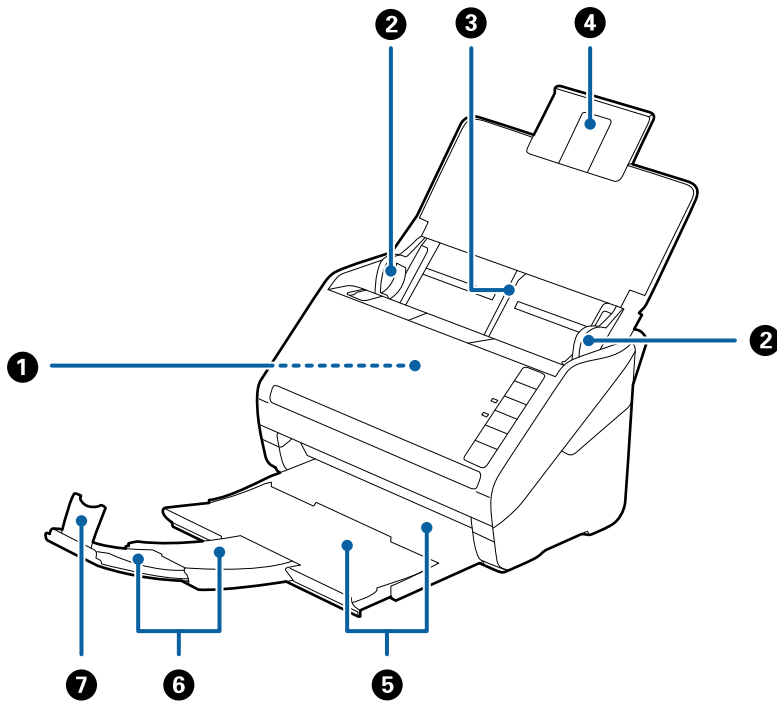

①	ADF (Automatic Document Feeder)	Feeds loaded originals automatically.
②	Edge guides	Feeds originals straight into the scanner. Slide to the edges of the originals.
③	Input tray	Loads originals. Pull out the tray extension if originals are too big for the input tray. This prevents paper from curling and causing paper jams.
④	Input tray extension	
⑤	Output tray	Holds originals ejected from the scanner. Pull out the extension tray to the length of the originals.
⑥	Output tray extension	
⑦	Stopper	Prevents ejected originals from falling off the extension tray. Adjust it to the length of the originals.

Back

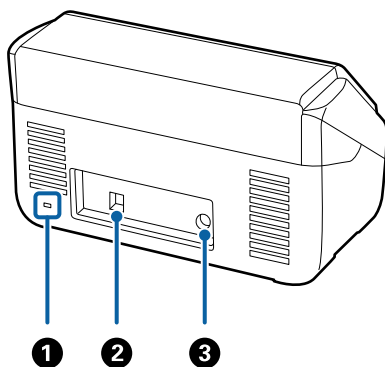

①	Security slot	Inserts a security lock for theft prevention.
②	USB port	Connects a USB cable.
③	DC inlet	Connects the AC adapter.

Inside

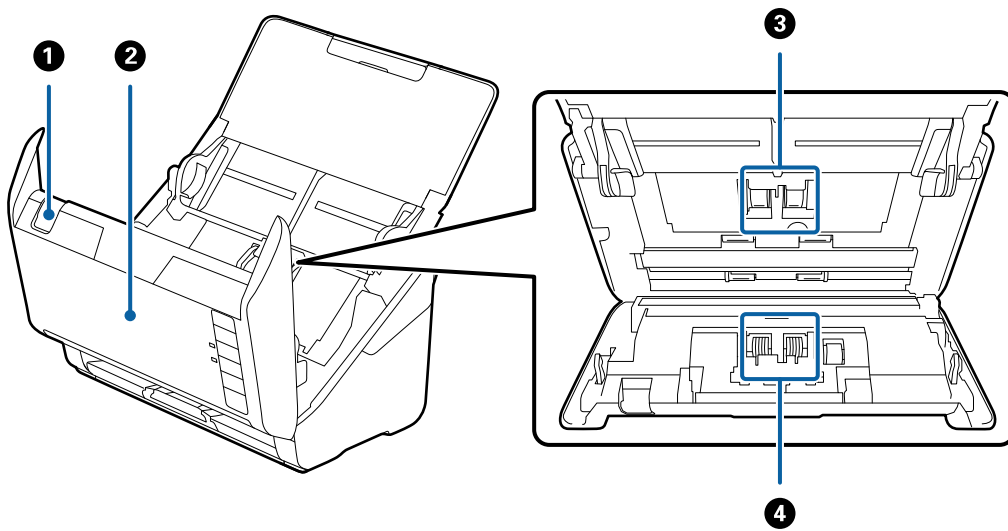

①	Cover open lever	Pull the cover open lever and open the scanner cover.
②	Scanner cover	Pull the cover open lever and open the scanner cover when cleaning inside of the scanner and removing jammed paper.
③	Pickup roller	Feeds originals. This needs to be replaced when the number of scans exceeds the service number of papers.
④	Separation roller	Feeds originals separately one by one. This needs to be replaced when the number of scans exceeds the service number of papers.

Related Information

- ➔ [“Cleaning Inside the Scanner” on page 82](#)
- ➔ [“Replacing the Roller Assembly Kit” on page 88](#)

Buttons and Lights on the Control Panel

Buttons

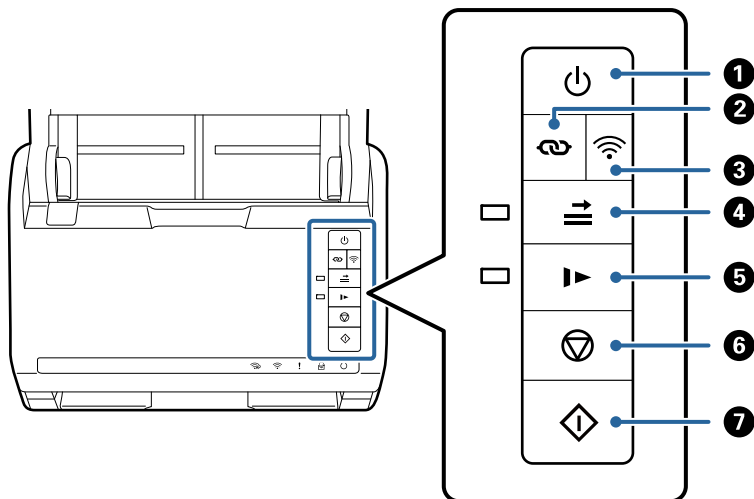

1		Power button	Turns the scanner on or off.
2		Wi-Fi connect button	Press the WPS button on the access point, and then press the button for more than three seconds to connect to a Wi-Fi network. See the chapter "Network Settings" for more details. Press the button to cancel the settings.
3		Wi-Fi on/off button	Press this button for more than three seconds to turn off the wireless signal. Press again to turn on the signal.
4		Double feed detection skip button	Normally, an error occurs when detecting double feeds when loading envelopes, plastic cards, originals with labels or stickers, and so on. Press the button before scanning to skip this error once (one sheet). The light is on when this is enabled. Follow the steps below to restart scanning when a double feed error has occurred (the error light flashes). <ol style="list-style-type: none"> 1. Open the scanner cover, and then remove the originals. 2. Close the scanner cover, and then press the button. 3. Load the originals. 4. Restart scanning by pressing the start button or the software button.
5		Slow mode button	Slow down the feeding speed when scanning. The light is on when this is enabled. Press this button in the following situations: <ul style="list-style-type: none"> <input type="checkbox"/> when originals jam frequently <input type="checkbox"/> when loading thin originals

6		Stop button	<ul style="list-style-type: none"> <input type="checkbox"/> Cancels scanning. <input type="checkbox"/> Finishes Automatic Feeding Mode. <input type="checkbox"/> Cancels Wi-Fi settings by push button setup (WPS). <input type="checkbox"/> Press this to release the error when a network connection error occurs. <input type="checkbox"/> Cancels a firmware update over a network connection.
7		Start button	<ul style="list-style-type: none"> <input type="checkbox"/> Starts scanning. <input type="checkbox"/> Press this when cleaning the inside of the scanner.

Additional functions are available with different combinations of buttons.

	Hold down the and buttons for more than three seconds to start PIN Code Setup (WPS). See the chapter "Network Settings" for more details.
	Turn on the scanner while holding down the button to restore the default network settings.



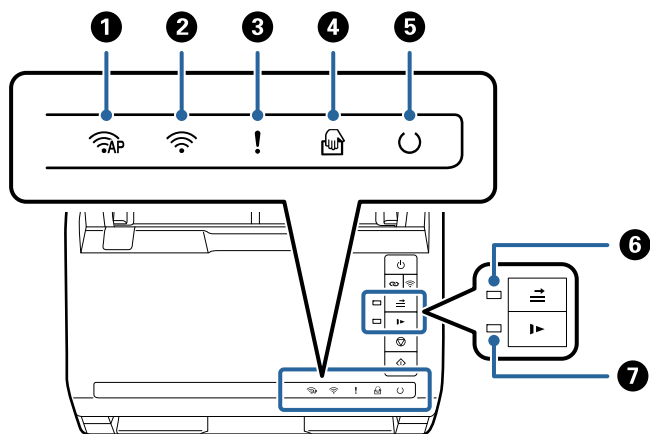

Related Information

- ➔ ["Placing Plastic Cards" on page 43](#)
- ➔ ["Placing Laminated Cards" on page 46](#)
- ➔ ["Placing Envelopes" on page 58](#)
- ➔ ["Cleaning Inside the Scanner" on page 82](#)

Lights



1		AP mode light	Indicates that the scanner is connected wirelessly in AP mode.
2		Wi-Fi light	Blue indicates that the scanner is connected to a wireless (Wi-Fi) network. White indicates it is searching for an access point.
3		Error light	An error has occurred. See "Light Error Indicators" for more details.

4		Automatic Feeding Mode light	The scanner is in Automatic Feeding Mode. Scanning starts when an original is placed in the input tray.	
5		Ready light	On:	The scanner is ready to be used.
			Flashing:	The scanner is scanning, waiting to scan, processing, or sleeping.
			Off:	The scanner cannot be used because the power is off or an error has occurred.
6		Skip double feed detection light	This is on when skipping double feed detection is enabled.	
7		Slow mode light	This is on during slow mode.	

Related Information







➔ [“Error Indicators” on page 22](#)







➔ [“Scanning Different Sizes or Types of Originals One by One Continuously \(Automatic Feeding Mode\)” on page 73](#)

You can scan different sizes or types of originals one by one using Automatic Feeding Mode. In this mode, the scanner starts scanning automatically when originals are loaded into the scanner.







Error Indicators

Scanner errors

Indicators	Situation	Solutions
 Flashing slowly	A paper jam or double feed occurred.	Open the scanner cover, and then remove jammed originals. Close the cover to release the error. Load the originals again.
 On	The scanner cover is opened.	Close the scanner cover.
 AP Flashing fast  Flashing fast  Flashing fast  Flashing fast	A fatal error has occurred.	Turn the power off and on again. If the error continues to occur, contact your local dealer.

Indicators	Situation	Solutions
 AP On  On  On  On  Off  On  On	<p>The scanner has started in recovery mode because the firmware update failed.</p>	<p>Follow the steps below to try to update the firmware again.</p> <ol style="list-style-type: none"> 1. Connect the computer and the scanner with a USB cable. (During recovery mode, you cannot update the firmware over a network connection.) 2. Visit your local Epson website for further instructions.

Network connection errors

Indicators	Situation	Solutions
 Flashing slowly  On	<p>An access point settings error has occurred.</p>	<p>Press the  button to release the error, and then restart the devices you want to connect to the network. Reconnect to the network.</p>
 Flashing slowly  Flashing slowly	<p>An access point settings error has occurred (a security error).</p>	
 Flashing slowly (white)  Flashing slowly	<p>A network connection error has occurred (the Date and Time has not been set correctly)</p>	<p>Re-set the Date and Time in Web Config.</p>

Related Information

- ➔ [“Application for Configuring Scanner Operations \(Web Config\)” on page 24](#)
- ➔ [“Removing Jammed Originals from the Scanner” on page 107](#)
- ➔ [“Connecting the Scanner to the Network” on page 65](#)

Information on Applications

This section introduces the application products available for your scanner. The latest application can be installed at the Epson Web site.

Application for Scanning from a Computer (Epson ScanSmart)

This application allows you to scan documents easily, and then save the scanned images in simple steps. See the Epson ScanSmart help for details on using the features.

Starting on Windows

- Windows 10

Click the start button, and then select **Epson Software > Epson ScanSmart**.

Windows 8.1/Windows 8

Enter the application name in the search charm, and then select the displayed icon.

Windows 7

Click the start button, and then select **All Programs > Epson Software > Epson ScanSmart**.

Starting on Mac OS

Select **Go > Applications > Epson Software > Epson ScanSmart**.

Application for Scanning Documents from a Smart Device (Epson Smart Panel)

Epson Smart Panel is an application that allows you to scan documents using smart devices such as smart phones and tablet devices. You can save the scanned data in smart devices or cloud services, and send by e-mail.

Even if you do not have a wireless router, you can automatically connect Wi-Fi enabled smart devices to the scanner by using Wi-Fi Direct.

Application for Updating Software and Firmware (EPSON Software Updater)

EPSON Software Updater is an application that installs new software, and updates firmware and manuals over the Internet. If you want to check for update information regularly, you can set the interval for checking for updates in EPSON Software Updater's auto update settings.

Starting on Windows

Windows 10

Click the start button, and then select **Epson Software > EPSON Software Updater**.

Windows 8.1/Windows 8

Enter the application name in the search charm, and then select the displayed icon.

Windows 7

Click the start button, and then select **All Programs > Epson Software > EPSON Software Updater**.

Starting on Mac OS

Select **Go > Applications > Epson Software > EPSON Software Updater**.

Application for Configuring Scanner Operations (Web Config)

Web Config is an application that runs in a web browser, such as Internet Explorer and Safari, on a computer or smart device. You can confirm the scanner status or change the network service and scanner settings. To use the Web Config, connect the scanner and the computer or device to the same network.

The following browsers are supported.

Microsoft Edge, Internet Explorer 8 or later, Firefox*, Chrome*, Safari*

* Use the latest version.

Running Web Config on a Web Browser

1. Launch a Web browser from a computer or smart device, and then enter the scanner's IP address.

Format:

IPv4: http://the scanner's IP address/

IPv6: http://[the scanner's IP address]/

Examples:

IPv4: http://192.168.100.201/

IPv6: http://[2001:db8::1000:1]/

Note:

- Since the scanner uses a self-signed certificate when accessing HTTPS, a warning is displayed on the browser when you start Web Config; this does not indicate a problem and can be safely ignored.
- If the administrator password has not been set when accessing Web Config, you need to set a user name and password.



Important:

Do not forget the user name and the password. If you forget them, you will need to contact Epson service support.

2. If you want to change the scanner settings, you need to login as an administrator.

Click **Administrator Login** at the top-right of the screen. Enter the **User Name** and **Current password**, and then click **OK**.

Note:

If **Administrator Logout** is displayed at the top-right of the screen, you have already logged-on as an administrator.

Related Information

- ➔ [“Checking the Scanner's IP Address” on page 67](#)

Running Web Config on Windows

When connecting a computer to the scanner using WSD, follow the steps below to run Web Config.

1. Open the scanner list on the computer.
 - Windows 10
Click on the start button, and then select **Windows System > Control Panel > View devices and printers** in **Hardware and Sound**.
 - Windows 8.1/Windows 8
Select **Desktop > Settings > Control Panel > View devices and printers** in **Hardware and Sound** (or **Hardware**).
 - Windows 7
Click the start button, and select **Control Panel > View devices and printers** in **Hardware and Sound**.
2. Right-click on your scanner and select **Properties**.

3. Select the **Web Service** tab and click the URL.

Since the scanner uses a self-signed certificate when accessing HTTPS, a warning is displayed on the browser when you start Web Config; this does not indicate a problem and can be safely ignored.

Note:

If the administrator password has not been set when accessing Web Config, you need to set a user name and password.



Important:

Do not forget the user name and the password. If you forget them, you will need to contact Epson service support.

Application for Setting up the Device on a Network (EpsonNet Config)

EpsonNet Config is an application that allows you to set the network interface addresses and protocols. See the operations guide for EpsonNet Config or the application's help for more details.

Starting on Windows

- Windows 10

Click the start button, and then select **EpsonNet > EpsonNet Config**.

- Windows 8.1/Windows 8

Enter the application name in the search charm, and then select the displayed icon.

- Windows 7/Windows Vista/Windows XP

Click the start button, and select **All Programs** or **Programs > EpsonNet > EpsonNet Config SE > EpsonNet Config**.

Starting on Mac OS

Go > Applications > Epson Software > EpsonNet > EpsonNet Config SE > EpsonNet Config.

Software for Managing Devices on the Network (Epson Device Admin)

Epson Device Admin is a multifunctional application software that manages the device on the network.

The following functions are available.

- Monitor or manage up to 2,000 printers or scanners over the segment
- Make a detailed report, such as for the consumable or product status
- Update the firmware of the product
- Introduce the device to the network
- Apply the unified settings to multiple devices.

You can download Epson Device Admin from Epson support website. For more information, see the documentation or help of Epson Device Admin.

Application for Creating Driver Packages (EpsonNet SetupManager)

EpsonNet SetupManager is a software to create a package for a simple scanner installation, such as installing the scanner driver and so on. This software allows the administrator to create unique software packages and distribute them among groups.

For more information, visit your regional Epson website.

<http://www.epson.com>

Option Items and Consumables Information

Carrier Sheet Codes

Using a Carrier Sheet allows you to scan irregular shaped originals or photos that can be easily scratched. You can scan originals larger than A4 size with a carrier sheet by folding it in half.

Part name	Codes*1	Replacement cycle
Carrier Sheet	B12B819051	3,000*2

*1 You can only use the carrier sheet with the code.

*2 This number is a guide to the replacement cycle. Do not use a Carrier Sheet that is scratched.

Related Information

- ➔ “General Specifications for Originals being Scanned” on page 30
- ➔ “Placing Large Size Originals” on page 49
- ➔ “Placing Irregular Shaped Originals” on page 52
- ➔ “Placing Photographs” on page 55

Roller Assembly Kit Codes

Parts (the pickup roller and separation roller) should be replaced when the number of scans exceeds the service number. You can check the latest number of scans in the Epson Scan 2 Utility.

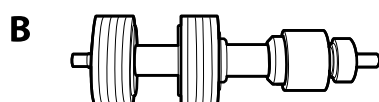
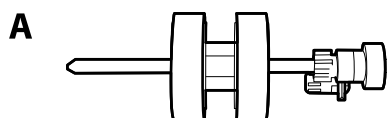

A: pickup roller, B: separation roller

Part name	Codes	Life cycle
Roller Assembly Kit	B12B819671 B12B819681 (India only)	200,000*

* This number was reached by consecutively scanning using Epson test original papers, and is a guide to the replacement cycle. The replacement cycle may vary depending on different paper types, such as paper that generates a lot of paper dust or paper with a rough surface that may shorten the life cycle.

Related Information

- ➔ [“Replacing the Roller Assembly Kit” on page 88](#)
- ➔ [“Resetting the Number of Scans After Replacing the Rollers” on page 92](#)

Cleaning Kit Codes

Use this when cleaning inside the scanner. This kit is composed of cleaning liquid and a cleaning cloth.

Part name	Codes
Cleaning Kit	B12B819291

Related Information

- ➔ [“Cleaning Inside the Scanner” on page 82](#)

Specifications of Originals and Placing Originals

Specifications of Originals.	30
Placing Originals.	35

Specifications of Originals

This section explains the specifications and conditions of originals that can be loaded in the ADF.

General Specifications for Originals being Scanned

Type of Original	Thickness	Size
Plain paper	27 to 413 g/m ²	Maximum: 215.9×6,096.0 mm (8.5×240.0 in.)
Fine paper	A8 size or less: 127 to 413 g/m ²	Minimum: 50.8×50.8 mm (2.0×2.0 in.)
Recycled paper	Plastic cards: 1.24 mm (0.05 in.) or less (including emboss)	The loadable size varies depending on the type of the originals and the scanning resolution.
Post card	Laminated Cards: 0.8 mm (0.03 in.) or less	
Business card		
Envelopes		
Plastic cards complying with ISO7810 ID-1 type (with or without emboss)		
Laminated cards		
Thermal paper		

Note:

- ❑ All originals must be flat at the leading edge.
- ❑ Make sure that curls on the leading edge of the originals are kept within the following range.
 - ① must be 3 mm or less.
 - ② must be 1 mm or less while ② is equal to or less than ③. When ③ is equal to or more than 10 times the size of ②, ② can be more than 1 mm.

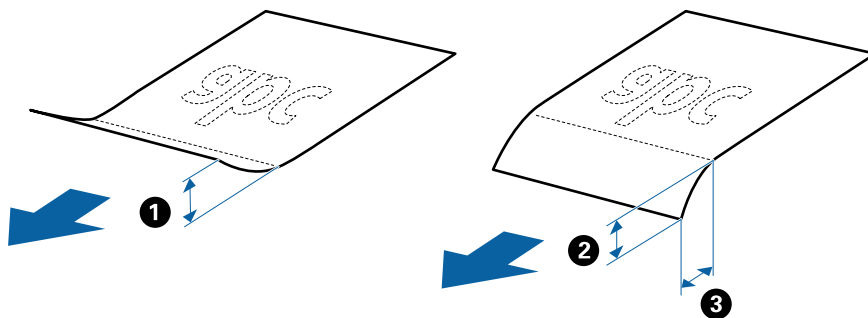

- ❑ Even when the original meets the specifications for originals that can be placed in the ADF, it may not feed from the ADF or the scan quality may decline depending on the paper properties or quality.

Specifications of Standard Size Originals

The list of the standard size originals you can load on the scanner.

Size	Measurement	Thickness	Paper Type	Loading Capacity *
A4	210×297 mm (8.3×11.7 in.)	27 to 413 g/m ²	Plain paper Fine paper Recycled paper	Thickness of the originals stack: under 6 mm (0.23 in.) 80 g/m ² : 50 sheets 90 g/m ² : 43 sheets 104 g/m ² : 37 sheets 127 g/m ² : 31 sheets 157 g/m ² : 25 sheets 209 g/m ² : 19 sheets 256 g/m ² : 15 sheets 413 g/m ² : 9 sheets The loading capacity varies depending on the paper type.
Letter	215.9×279.4 mm (8.5×11 in.)			
Legal	215.9×355.6 mm (8.5×14 in.)			
B5	182×257 mm (7.2×10.1 in.)			
A5	148×210 mm (5.8×8.3 in.)			
B6	128×182 mm (5.0×7.2 in.)			
A6	105×148 mm (4.1×5.8 in.)			
A8	52×74 mm (2.1×2.9 in.)	127 to 413 g/m ²		
Business Card	55×89 mm (2.1×3.4 in.)	210 g/m ²		Thickness of the originals stack: under 6 mm (0.23 in.) 15 sheets

* You can refill the originals up to the maximum capacity during scanning.

Specifications of Long Paper

The specification of long paper you can load into the scanner.

Size	Thickness	Paper Type	Loading Capacity
Maximum width: 215.9 mm (8.5 in.) Maximum length: 6,096.0 mm (240.0 in.)*	50 to 130 g/m ²	Plain paper Fine paper Recycled paper	1 sheet

* The following shows the maximum lengths according to the scanning resolution.

- 50 to 200 dpi : 6,096.0 mm (240.0 in.)
- 201 to 300 dpi : 5,461.0 mm (215.0 in.)
- 301 to 600 dpi : 1,346.0 mm (53.0 in.)

Note:

You cannot scan long paper using Epson Smart Panel.

Specifications of Plastic Cards

The specification of plastic card you can load into the scanner.

Size	Card Type	Thickness	Loading Capacity	Loading Direction
ISO7810 ID-1 Type 54.0×85.6 mm (2.1×3.3 in.)	With embossing	1.24 mm (0.05 in.) or less	1 card	Horizontal (Landscape)
	Without embossing	0.76 mm (0.03 in.) to 1.1 mm (0.04 in.) *	5 cards	
		Less than 0.76 mm (0.03 in.)	5 cards	

* You can scan these cards only when the resolution is 300 dpi or less, and disabling **Slow** mode.

Specifications of Laminated Cards

The specification of laminated cards you can load into the scanner.

Size	Thickness	Loading Capacity
120.0×150.0 mm (4.7×5.9 in.) or less	0.8 mm (0.03 in.) or less	1 card

Note:

You cannot scan laminated cards using Epson Smart Panel.

Specifications for Originals Using the Carrier Sheet

The optional Carrier Sheet is a sheet designed to transport originals through the scanner. You can scan originals that are larger than A4/Letter size, important documents or photos which must not be damaged, thin paper, irregular shaped originals, and so on.

The following table provides the conditions for using the Carrier Sheet.

Type	Size	Thickness	Loading Capacity of the Carrier Sheet
Originals that cannot be loaded directly into the scanner	A3* ¹ A4 B4* ¹ Letter Legal* ¹ B5 A5 B6 A6 A8 Custom size: <input type="checkbox"/> Width: up to 431.8 mm (17 in.) * ² <input type="checkbox"/> Length: up to 297 mm (11.7 in.) * ³	0.3 mm (0.012 in.) or less (excluding the thickness of the Carrier Sheet)	5 sheets

*1 Fold in half to set.

*2 Originals that are wider than 215.9 mm (8.5 in.) need to be folded in half.

*3 The leading edge of the original must be placed at the binding part of the Carrier Sheet when scanning an original approximately 297 mm (11.7 in.) long. Otherwise, the length of the scanned image may be longer than intended as the scanner scans to the end of the Carrier Sheet when you select **Auto Detect** as the **Document Size** setting in the application.

Related Information

➔ [“Carrier Sheet Codes” on page 27](#)

Specifications of Envelopes

The specification of envelopes you can load into the scanner.

Size	Measurement	Thickness	Loading Capacity
C6	114×162 mm (4.49×6.38 in.) (standard size)	0.38 mm (0.015 in.) or less	5 envelopes
DL	110×220 mm (4.33×8.66 in.) (standard size)		

Types of Originals that Require Attention

The following types of originals may not be successfully scanned.

Originals with an uneven surface such as letter head paper

- Originals with wrinkles or fold lines
- Perforated originals
- Original with labels or stickers
- Carbon-less paper
- Curled originals
- Coated paper

Note:

- Because carbon-less paper contains chemical substances that may harm the rollers, if paper jams occur frequently, clean the pickup roller and the separation roller.*
- Wrinkled originals may scan better if you slow down the feeding speed during scanning or smooth out the wrinkles before loading.*
- To scan delicate originals or originals that are easily wrinkled, use the Carrier Sheet (sold separately).*
- To scan originals that are incorrectly detected as double feeds, press the  (Double Feed Detection Skip) button before scanning or select **Off** in **Detect Double Feed** on the **Main Settings** tab in Epson Scan 2 window.
*When you are using Epson ScanSmart, you can open the Epson Scan 2 window by pressing the **Settings** button > **Scanner Settings** tab > **Scan Settings**.**
- Labels or stickers must be firmly stuck to the originals with no glue protruding.*
- Try to flatten the curled originals before scanning.*

Related Information

- ➔ [“Scanner Basics” on page 17](#)
- ➔ [“Maintenance” on page 81](#)

Types of Originals that Must Not be Scanned

The following types of originals must not be scanned.

- Photos
- Booklets
- Bank books
- Passports
- Non-paper original (such as clear files, fabric, and metal foil)
- Originals with staples or paper clips
- Originals with glue attached
- Ripped originals
- Heavily wrinkled or curled originals
- Transparent originals such as OHP film
- Originals with carbon paper on the back
- Originals with wet ink
- Originals with sticky notes attached

Note:

- ❑ Do not feed photos, valuable original artwork, or important documents which you do not want to damage or deface into the scanner directly. Misfeeding may wrinkle or damage the original. When scanning such originals, make sure you use the Carrier Sheet (sold separately).
- ❑ Rippled, wrinkled, or curled originals can also be scanned if you use the Carrier Sheet (sold separately).

Related Information

➔ “Photographs” on page 54

Placing Originals

Standard Size Originals

Specifications of Standard Size Originals

The list of the standard size originals you can load on the scanner.

Size	Measurement	Thickness	Paper Type	Loading Capacity *
A4	210×297 mm (8.3×11.7 in.)	27 to 413 g/m ²	Plain paper Fine paper Recycled paper	Thickness of the originals stack: under 6 mm (0.23 in.) 80 g/m ² : 50 sheets 90 g/m ² : 43 sheets 104 g/m ² : 37 sheets 127 g/m ² : 31 sheets 157 g/m ² : 25 sheets 209 g/m ² : 19 sheets 256 g/m ² : 15 sheets 413 g/m ² : 9 sheets The loading capacity varies depending on the paper type.
Letter	215.9×279.4 mm (8.5×11 in.)			
Legal	215.9×355.6 mm (8.5×14 in.)			
B5	182×257 mm (7.2×10.1 in.)			
A5	148×210 mm (5.8×8.3 in.)			
B6	128×182 mm (5.0×7.2 in.)			
A6	105×148 mm (4.1×5.8 in.)			
A8	52×74 mm (2.1×2.9 in.)	127 to 413 g/m ²		
Business Card	55×89 mm (2.1×3.4 in.)	210 g/m ²		Thickness of the originals stack: under 6 mm (0.23 in.) 15 sheets

* You can refill the originals up to the maximum capacity during scanning.

Placing Standard Size Originals

1. Open the input tray and extend the input tray extension. Slide out the output tray, extend the output tray extension, and then raise the stopper.

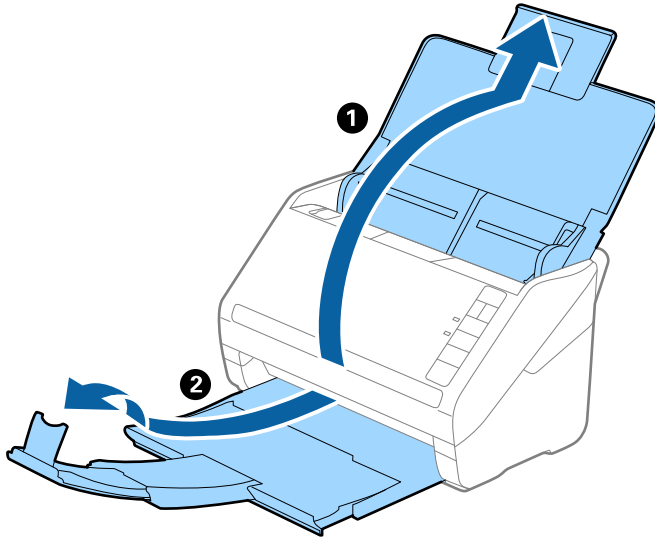

Note:

- ❑ For A4 size or larger originals, make sure you pull out and extend the input tray extension.
- ❑ Make sure you pull out and extend the output tray extensions so that they are a little bit longer than the length of the original, and raise the stopper so that the ejected originals can be stacked comfortably on the output tray.
- ❑ The stopper can move forward and backward on the output tray extension so that you can easily adjust the stopper position to the best position for the originals being scanned.
- ❑ If thick originals bump into the output tray and fall from it, store the output tray and do not use it to stack the ejected originals.
- ❑ If scanned images are still affected by ejected originals hitting the surface below the scanner, we recommend placing the scanner on the edge of a table where the ejected originals can drop freely and you can catch them.

2. Slide the edge guides on the input tray all the way out.

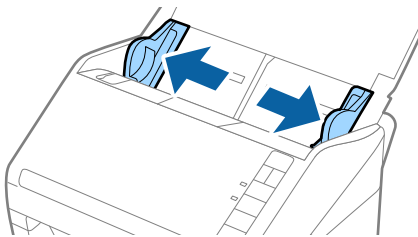

3. Fan the originals.

Hold both ends of the originals and fan them a few times.

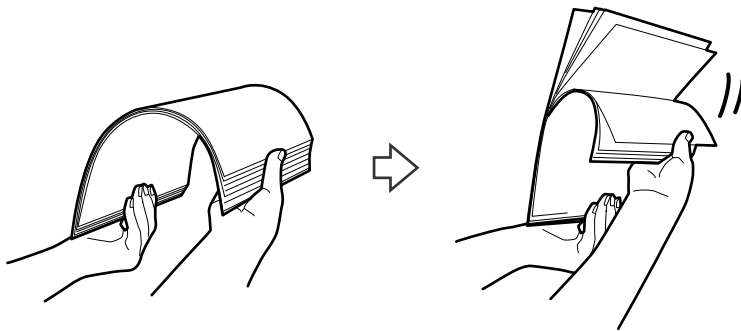

4. Align the edges of the originals with the printed side facing down and slide the leading edge into a wedge shape.

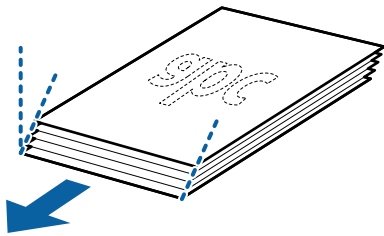

5. Load the originals into the input tray facing down with the top edge facing into the ADF. Slide the originals into the ADF until they meet resistance.

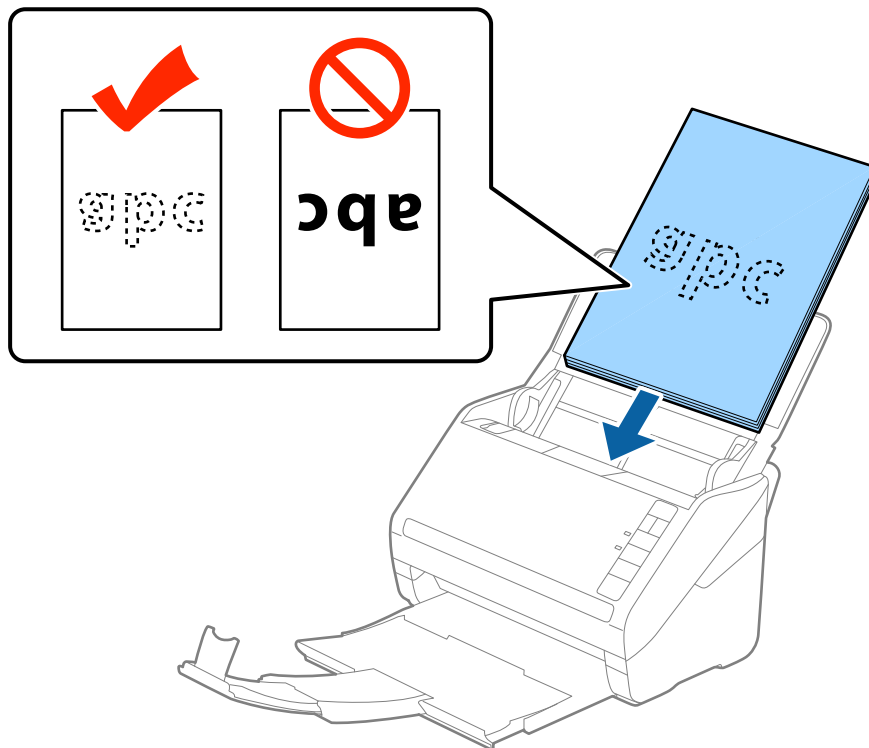

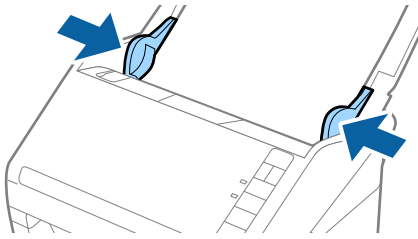

6. Slide the edge guides to fit the edge of the originals making sure there are no gaps between the originals and the edge guides. Otherwise, the originals may be fed skewed.

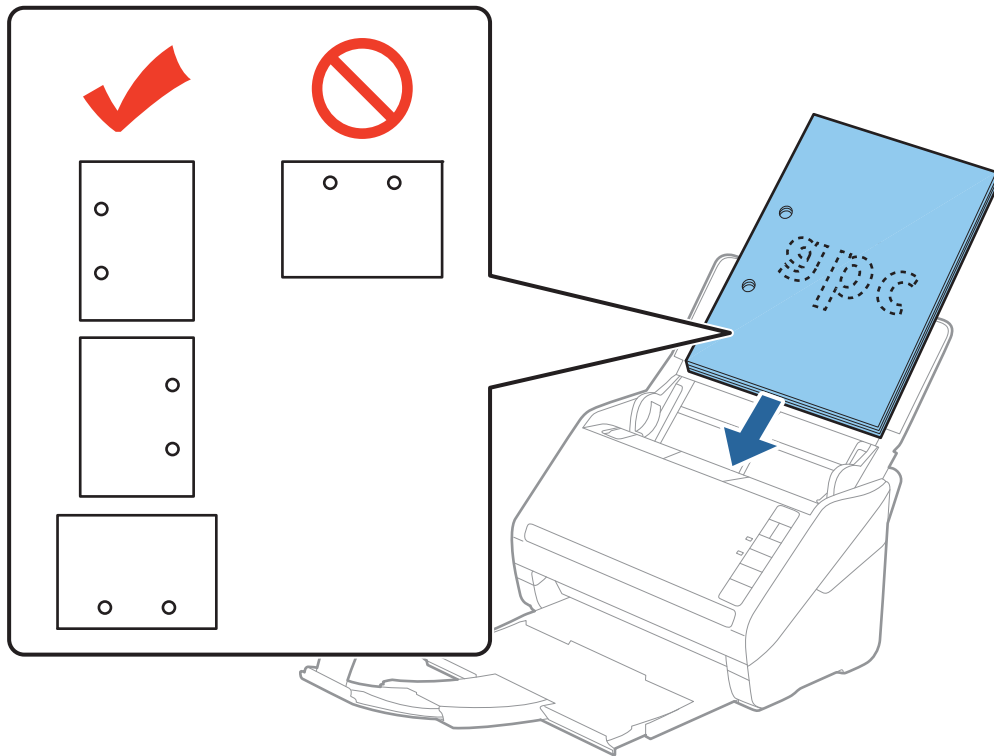

Note:

- ❑ When scanning originals with punch holes such as loose leaf paper, load the originals with the holes facing the side or facing down. There must not be any holes within a 30 mm (1.2 inches) strip at the center of the originals. However, there can be holes within 30 mm (1.2 inches) from the leading edge of the originals. Make sure that the edges of the punch holes do not have burrs or curls.



- ❑ When scanning thin paper with crinkles that are causing paper jams or double feeds, you may be able to improve the situation by pressing the  (Slow Mode) button to slow down the feeding speed. Pressing the  (Slow Mode) button once slows down the paper feeding speed; press it again to return to normal speed.

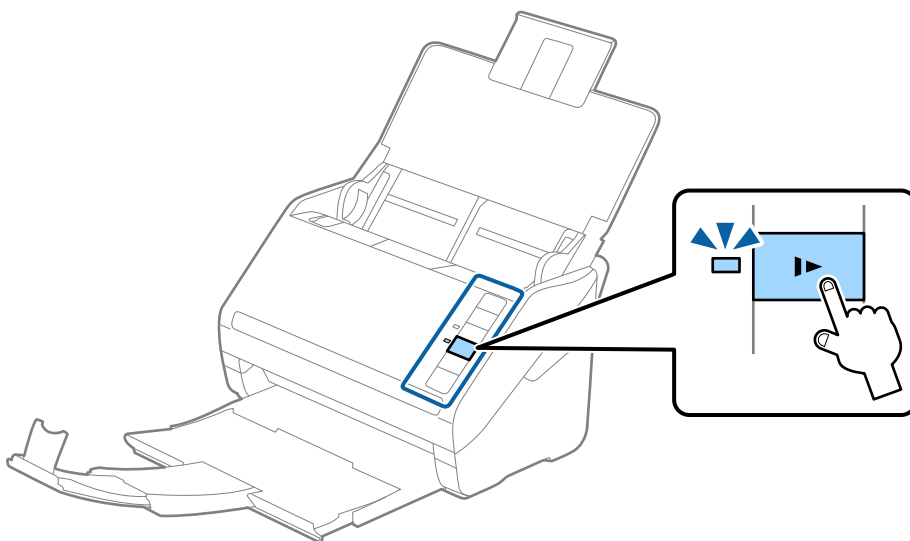

Long Paper

Specifications of Long Paper

The specification of long paper you can load into the scanner.

Size	Thickness	Paper Type	Loading Capacity
Maximum width: 215.9 mm (8.5 in.) Maximum length: 6,096.0 mm (240.0 in.)*	50 to 130 g/m ²	Plain paper Fine paper Recycled paper	1 sheet

* The following shows the maximum lengths according to the scanning resolution.

- ❑ 50 to 200 dpi : 6,096.0 mm (240.0 in.)
- ❑ 201 to 300 dpi : 5,461.0 mm (215.0 in.)
- ❑ 301 to 600 dpi : 1,346.0 mm (53.0 in.)

Note:

You cannot scan long paper using Epson Smart Panel.

Placing Long Paper

1. Open the input tray, and then slide out the output tray.

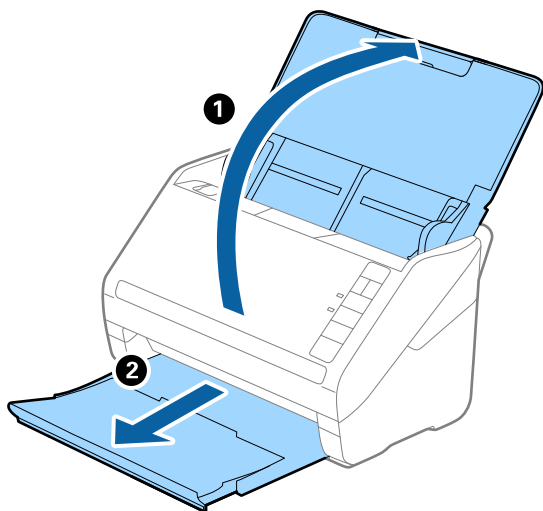

Note:

Do not extend the input tray extension and output tray extensions and do not raise the stopper.

- Slide the edge guides on the input tray all the way out.

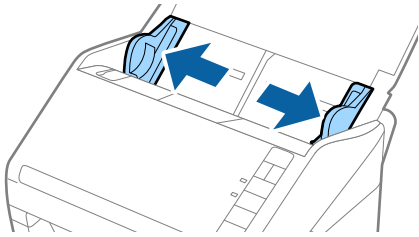

- Load the original straight into the input tray, facing down with the top edge facing into the ADF. Slide the original into the ADF until it meets resistance.

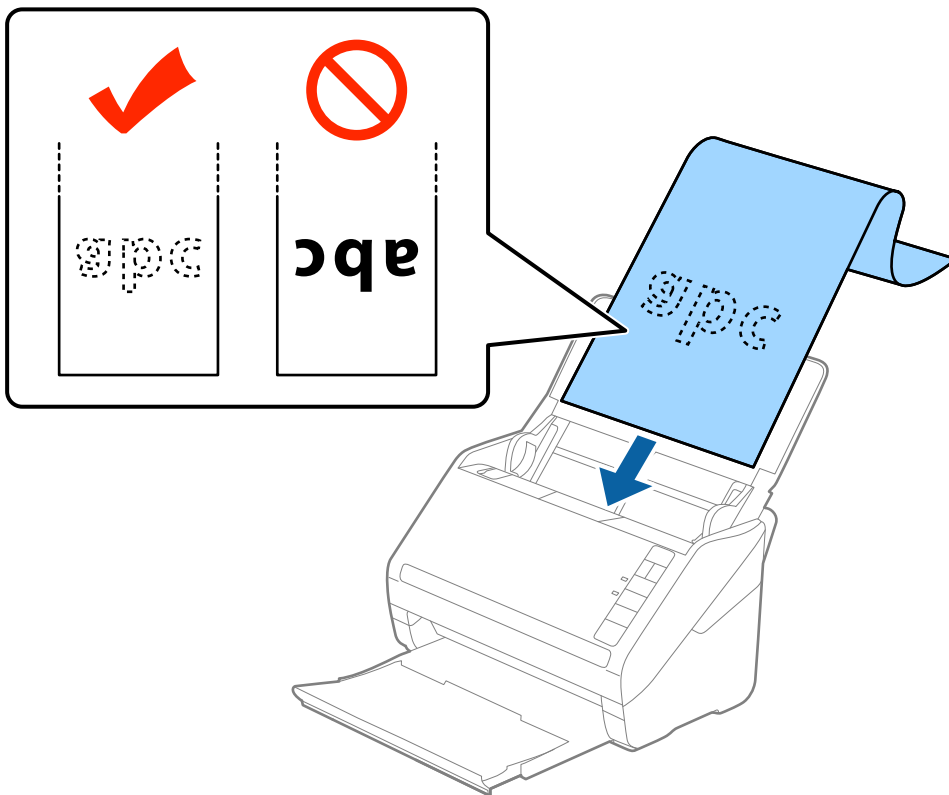

- Adjust the edge guides to fit the edge of the long paper making sure there are no gaps between the edge of the paper and the edge guides. Otherwise, the originals may be fed skewed.

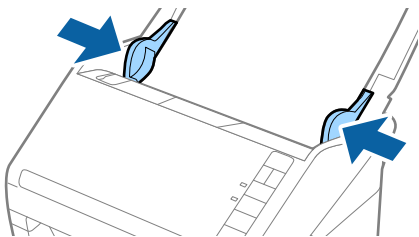

Note:

- ❑ The following shows the maximum lengths according to the scanning resolution.

- 50 to 200 dpi: 6,096.0 mm (240.0 in.)
- 201 to 300 dpi: 5,461.0 mm (215.0 in.)
- 301 to 600 dpi: 1,346.0 mm (53.0 in.)

- ❑ You need to specify the paper size in the Epson Scan 2 window.

When you are using Epson ScanSmart, you can open the Epson Scan 2 window by pressing the **Settings** button > **Scanner Settings** tab > **Scan Settings**.

There are three ways to specify the paper size in Epson Scan 2, if the paper length is 3,048 mm (120 inches) or less, you can select **Auto Detect (Long Paper)** to detect the size automatically.

If the paper length is more than 3,048 mm (120 inches), you need to select **Customize** and enter the size of the paper. If the paper length is 5,461 mm (215 inches) or less, you can use **Detect paper length** instead of entering the paper height. If the paper is longer than 5,461 mm (215 inches), you need to enter both width and height size of the paper.

- ❑ To guarantee scanning quality, the scanning speed for long paper is slowed down automatically.
- ❑ Support the long paper at the input side so that it does not drop out of the ADF, and the output side so that the ejected paper does not fall from the output tray.

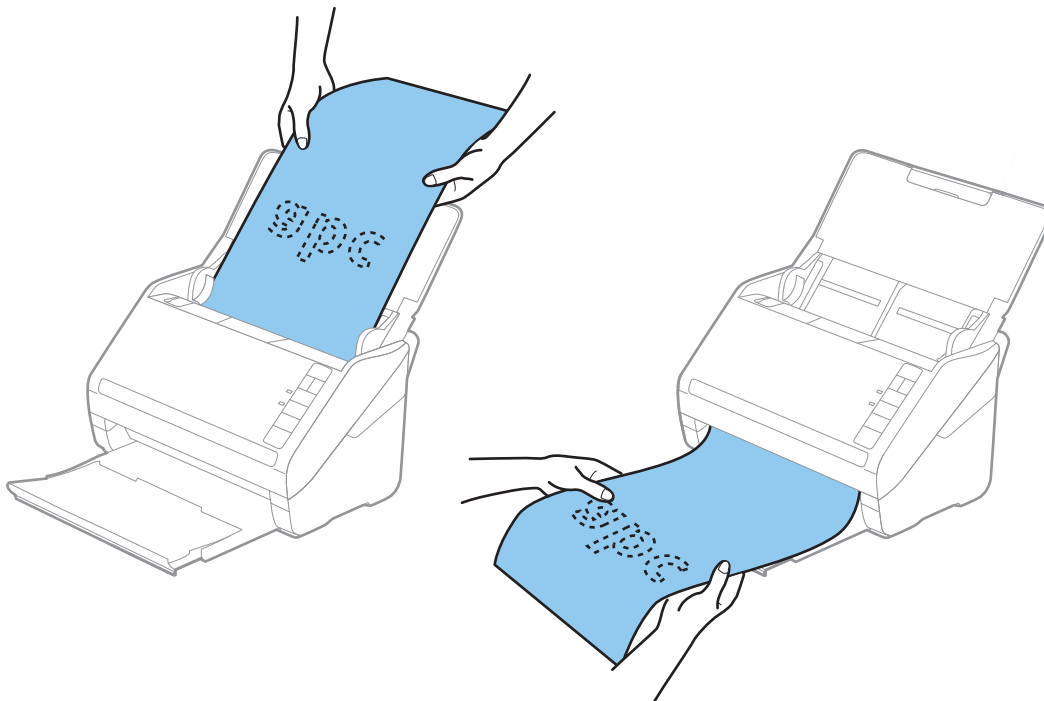

Related Information

- ➔ [“Required Settings for Special Originals in Epson Scan 2 Window” on page 72](#)

Plastic Cards

Specifications of Plastic Cards

The specification of plastic card you can load into the scanner.

Size	Card Type	Thickness	Loading Capacity	Loading Direction
ISO7810 ID-1 Type 54.0×85.6 mm (2.1×3.3 in.)	With embossing	1.24 mm (0.05 in.) or less	1 card	Horizontal (Landscape)
	Without embossing	0.76 mm (0.03 in.) to 1.1 mm (0.04 in.) *	5 cards	
		Less than 0.76 mm (0.03 in.)	5 cards	

* You can scan these cards only when the resolution is 300 dpi or less, and disabling **Slow** mode.

Placing Plastic Cards

1. Open the input tray, and then slide out the output tray and raise the stopper.

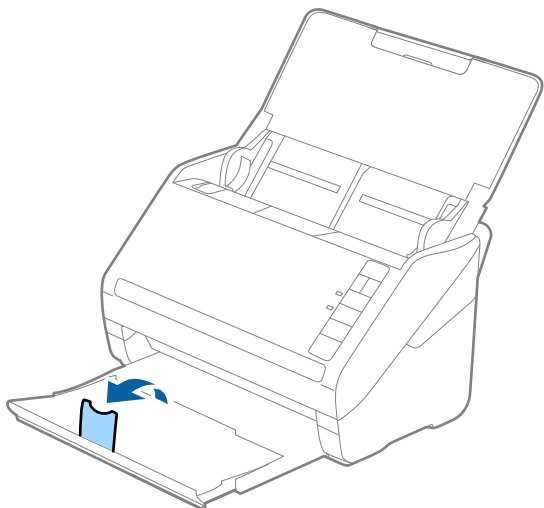

2. Slide the edge guides on the input tray all the way out.

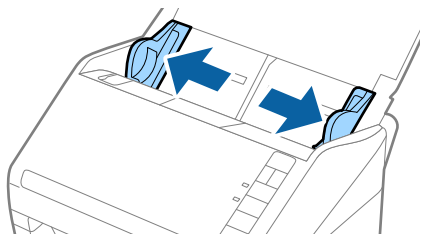

3. Load the plastic cards into the input tray facing down with the top edge facing into the ADF.
Slide the plastic cards into the ADF until they meet resistance.

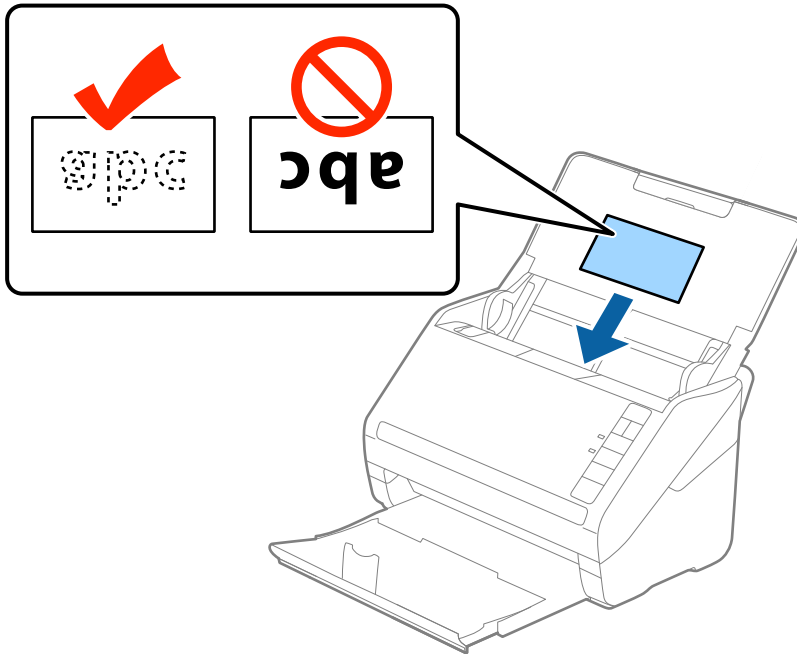

! *Important:*

Do not load plastic cards vertically.

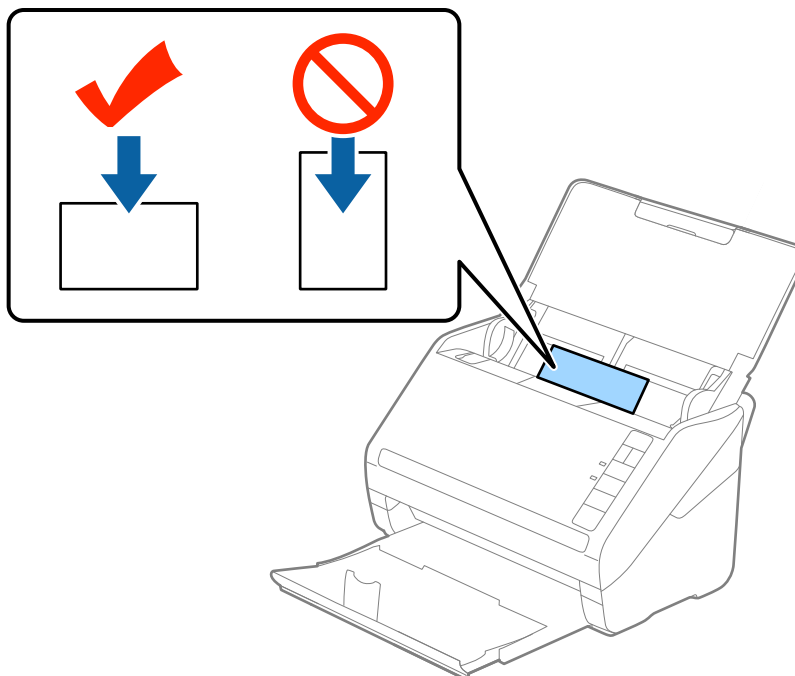

- Slide the edge guides to fit the edge of the plastic cards.

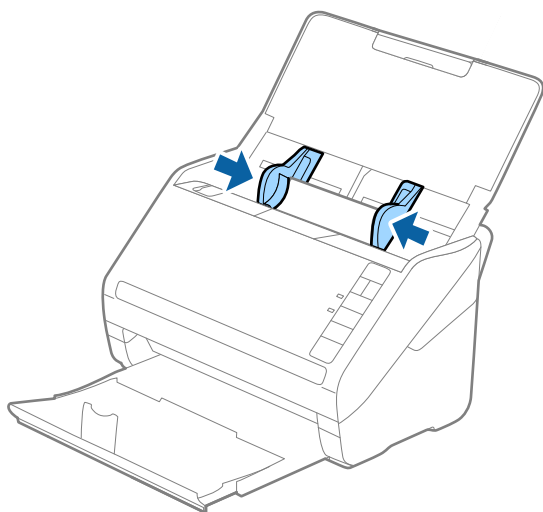



Note:

To scan plastic cards, set the appropriate setting in the Epson Scan 2 window.

When you are using Epson ScanSmart, you can open the Epson Scan 2 window by pressing the **Settings** button > **Scanner Settings** tab > **Scan Settings**.

Select **Plastic Card** in **Document Size** or select **Off** in **Detect Double Feed** on the **Main Settings** tab in Epson Scan 2. See the Epson Scan 2 help for details.

If you forget to disable **Detect Double Feed** in Epson Scan 2 and a double feed error occurs, remove the card from the ADF and then reload it, press the  (Double Feed Detection Skip) button on the scanner as shown below to disable **Detect Double Feed** for the next scan, and then scan again. The  (Double Feed Detection Skip) button only disables **Detect Double Feed** for one sheet.

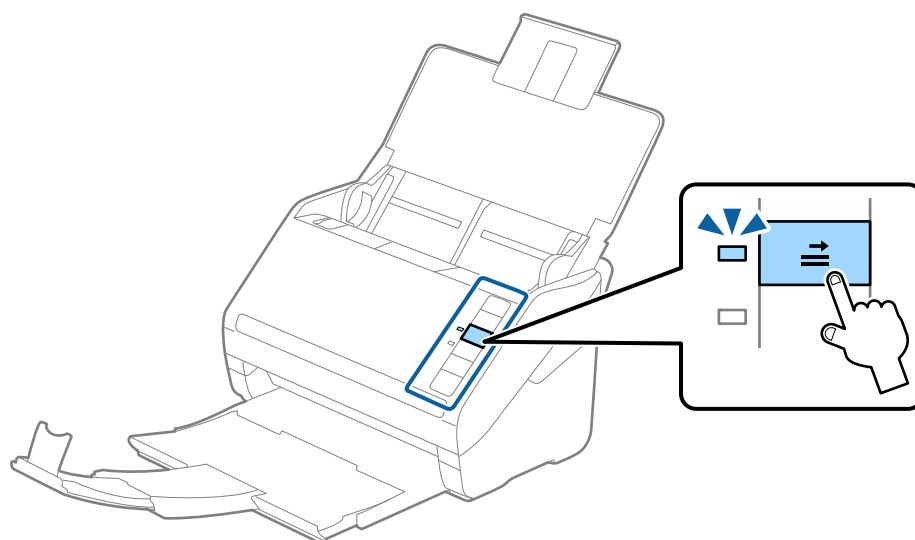

Related Information

➔ [“Required Settings for Special Originals in Epson Scan 2 Window” on page 72](#)

Laminated Cards

Specifications of Laminated Cards

The specification of laminated cards you can load into the scanner.

Size	Thickness	Loading Capacity
120.0×150.0 mm (4.7×5.9 in.) or less	0.8 mm (0.03 in.) or less	1 card

Note:

You cannot scan laminated cards using Epson Smart Panel.

Placing Laminated Cards

1. Open the input tray, and then slide out the output tray and raise the stopper.

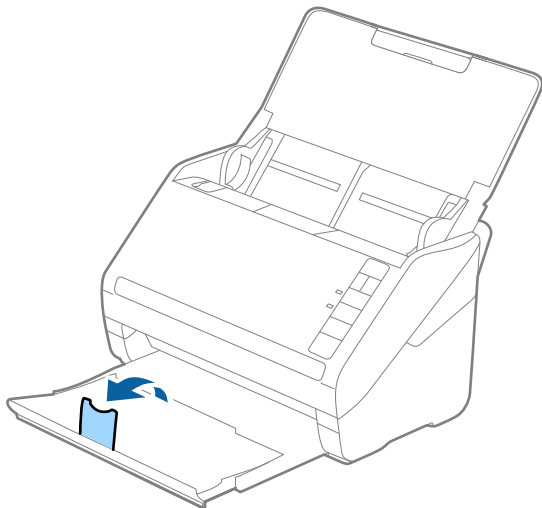

2. Slide the edge guides on the input tray all the way out.

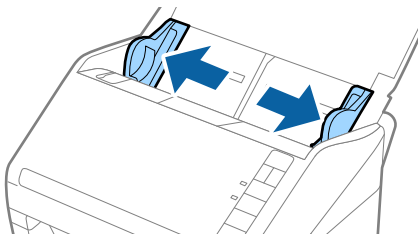

3. Load the laminated cards into the input tray facing down with the top edge facing into the ADF. Slide the laminated cards into the ADF until they meet resistance.

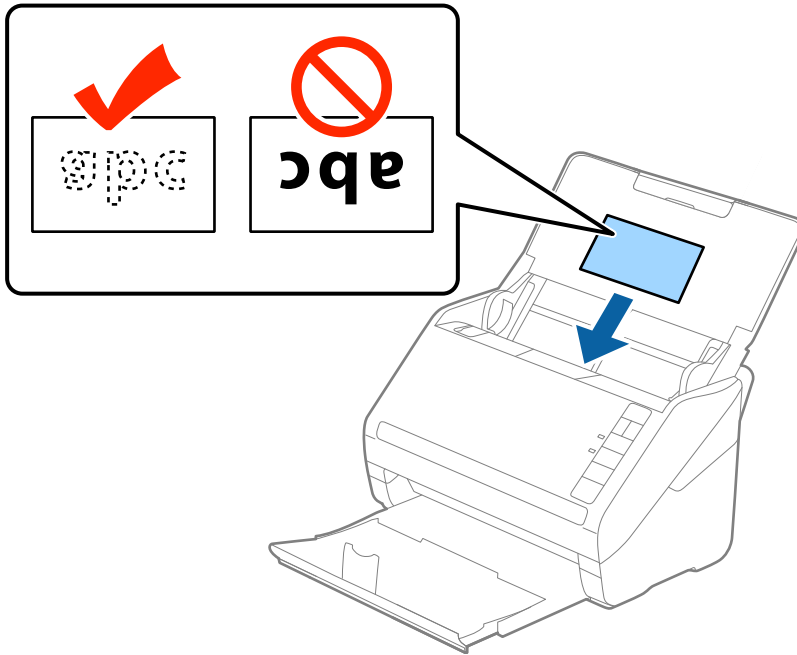

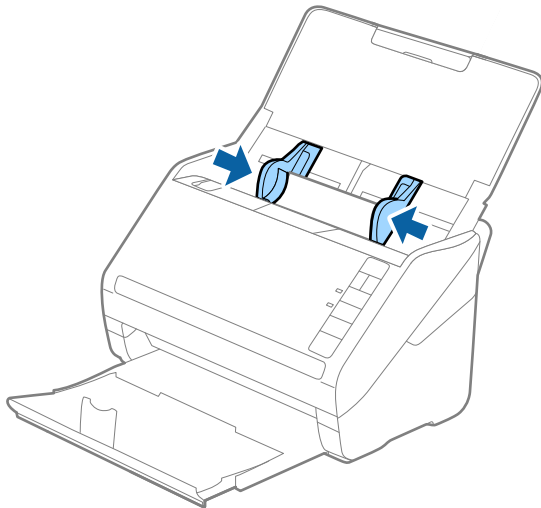

4. Slide the edge guides to fit the edge of the laminated cards.



Note:

To scan laminated cards, set the appropriate setting in the Epson Scan 2 window.

When you are using Epson ScanSmart, you can open the Epson Scan 2 window by pressing the **Settings** button > **Scanner Settings** tab > **Scan Settings**.

- ❑ Select **Scan laminated card** on the **Settings** window on the **Main Settings** tab in Epson Scan 2 to increase the accuracy of auto size detection. See the Epson Scan 2 help for details.
- ❑ Select **Off** in **Detect Double Feed** on the **Main Settings** tab in Epson Scan 2. See the Epson Scan 2 help for details.
If you forget to disable **Detect Double Feed** in Epson Scan 2 and a double feed error occurs, remove the card from the ADF and then reload it, press the  (Double Feed Detection Skip) button on the scanner as shown below to disable **Detect Double Feed** for the next scan, and then scan again. The  (Double Feed Detection Skip) button only disables **Detect Double Feed** for one sheet.

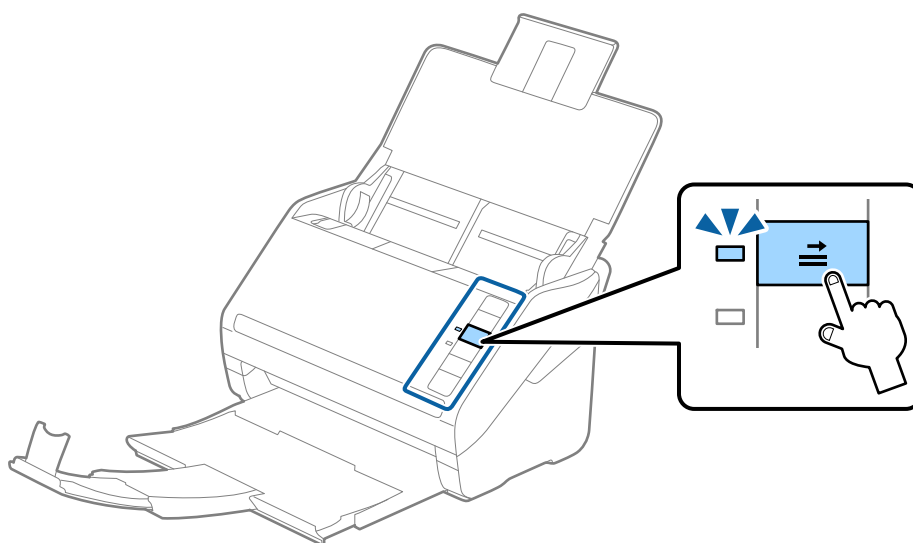

Related Information

➔ [“Required Settings for Special Originals in Epson Scan 2 Window” on page 72](#)

Large Size Originals

Specifications of Large Size Originals

By using the Carrier Sheet sold separately and folding the originals in half, you can scan originals larger than A4 size, such as A3 or B4 sizes.

Size	Thickness	Paper Type	Loading Capacity of the Carrier Sheet
Up to A3	0.3 mm (0.012 in.) or less (excluding the thickness of the Carrier Sheet)	Plain paper Fine paper Recycled paper	5 carrier sheets

Placing Large Size Originals

1. Open the input tray and extend the input tray extension. Slide out the output tray, extend the output tray extension, and then raise the stopper.

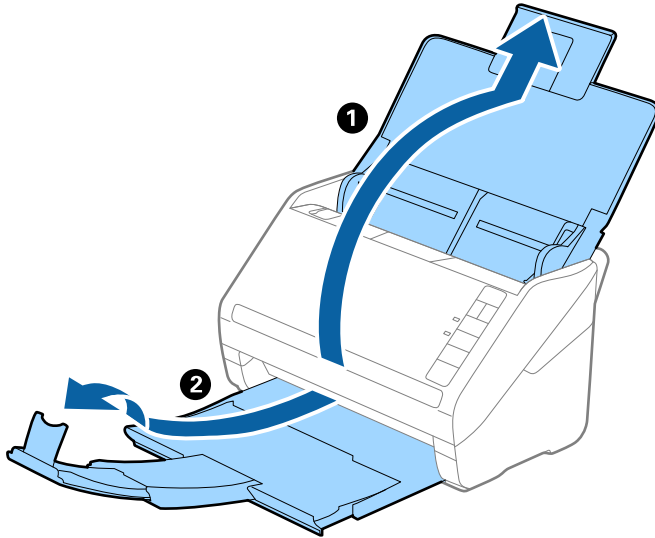

2. Slide the edge guides on the input tray all the way out.

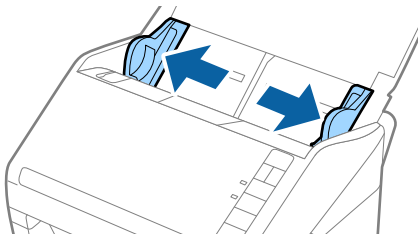

3. Place the Carrier Sheet with the illustration on the front edge facing up and place the original in the carrier sheet by folding it in half so that the side to be scanned is facing out, with the right side at the front.

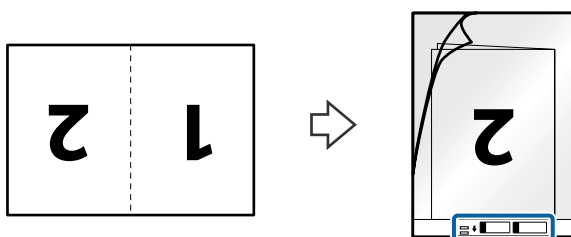

4. Load the Carrier Sheet into the input tray with the top edge facing into the ADF.
Slide the Carrier Sheet into the ADF until it meets resistance.

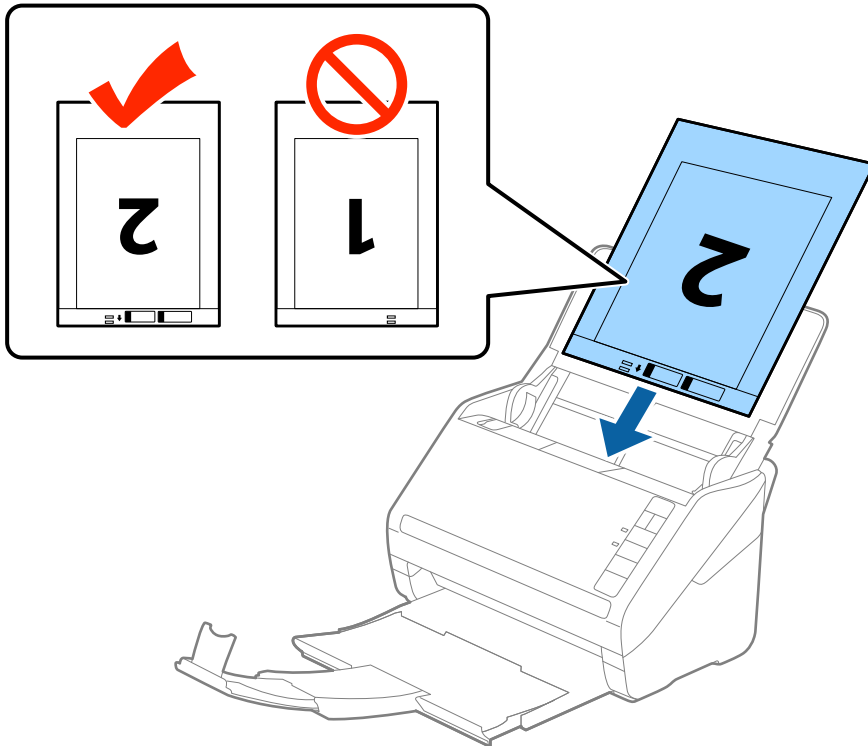

5. Slide the edge guides to fit the edge of the Carrier Sheet making sure there are no gaps between the Carrier Sheet and the edge guides. Otherwise, the carrier sheet may be fed skewed.

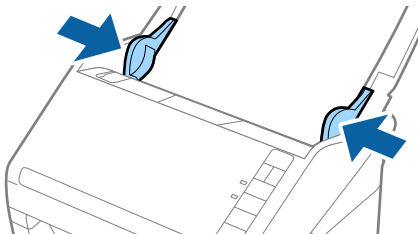

Note:

- ❑ You may need to stop using a Carrier Sheet that is scratched or has been scanned more than 3,000 times.
- ❑ To scan both sizes and stitch them together, select **Double-Sided** from **Scanning Side** and select **Left & Right** from **Stitch Images** in Epson Scan 2. See the Epson Scan 2 help for details.
- ❑ When scanning a Carrier Sheet by selecting **Auto Detect** as the **Document Size** setting, the image is automatically scanned by applying **Paper Skew** in the **Correct Document Skew** setting.
- ❑ The leading edge of the original must be placed at the binding part of the Carrier Sheet when scanning an original approximately 297 mm long. Otherwise, the length of the scanned image may be longer than intended as the scanner scans to the end of the Carrier Sheet when you select **Auto Detect** as the **Document Size** setting in Epson Scan 2.
- ❑ Only use the Carrier Sheet designed for your scanner. The Carrier Sheet is automatically recognized by the scanner by detecting two small rectangular holes on the front edge. Keep the holes clean and not covered.

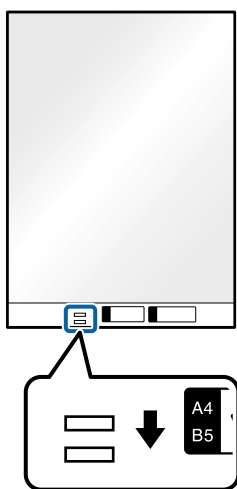

Related Information

- ➔ [“Carrier Sheet Codes” on page 27](#)
- ➔ [“Required Settings for Special Originals in Epson Scan 2 Window” on page 72](#)

Irregular Shaped Originals

Specifications of Irregular Shaped Originals

By using the Carrier Sheet sold separately, you can scan originals that are wrinkled, curled, very thin, or irregularly shaped.

Size	Thickness	Loading Capacity of the Carrier Sheet
Up to A4	0.3 mm (0.012 in.) or less (excluding the thickness of the Carrier Sheet)	5 sheets

Placing Irregular Shaped Originals

1. Open the input tray and extend the input tray extension. Slide out the output tray, extend the output tray extension, and then raise the stopper.

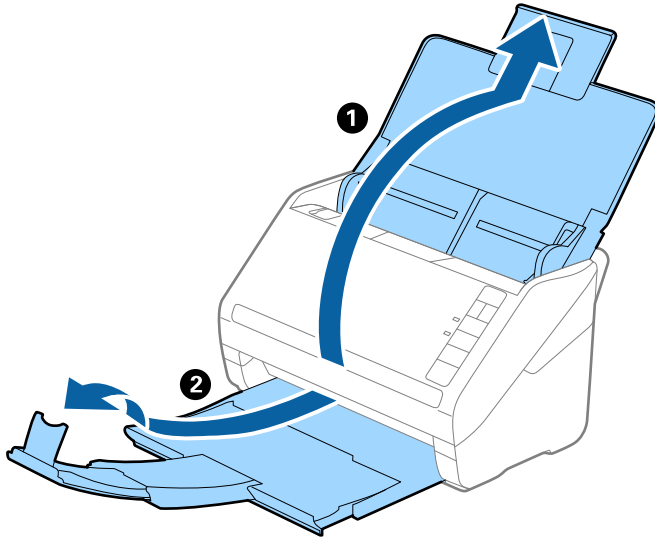

2. Slide the edge guides on the input tray all the way out.

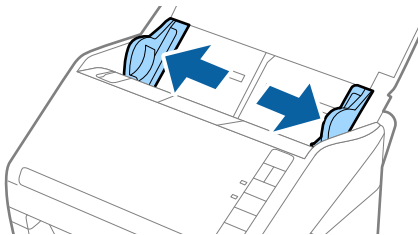

3. Place the Carrier Sheet with the illustration on the front edge facing up and place the original in the center of the Carrier Sheet with the side to be scanned facing down.

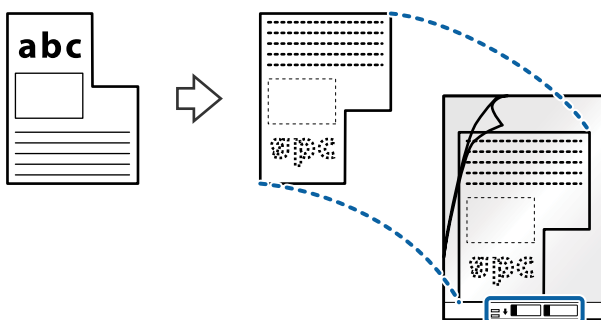

4. Load the Carrier Sheet into the input tray with the top edge facing into the ADF.
Slide the Carrier Sheet into the ADF until it meets resistance.

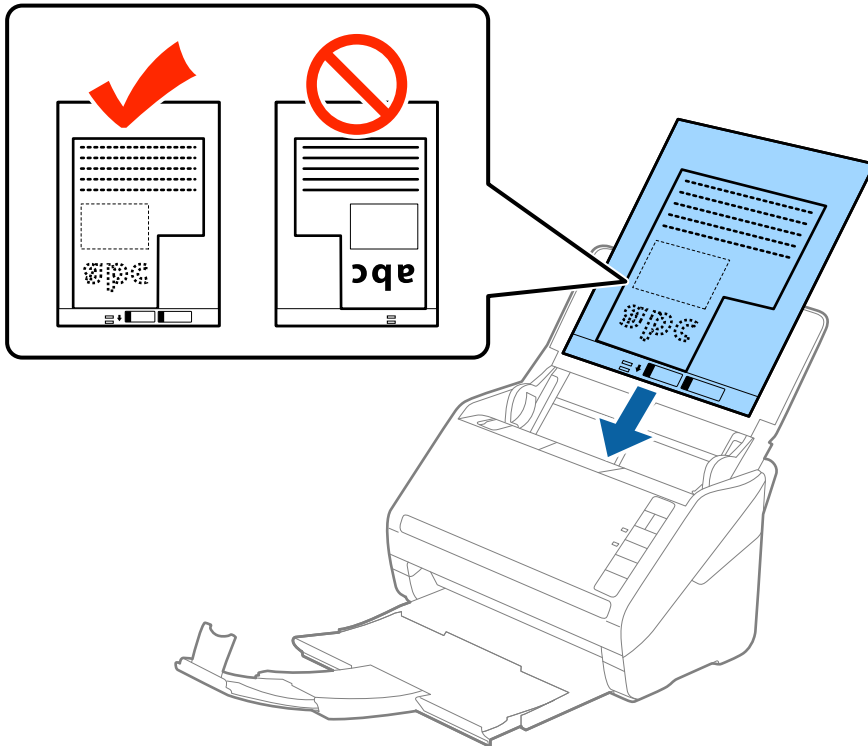

5. Slide the edge guides to fit the edge of the Carrier Sheet making sure there are no gaps between the Carrier Sheet and the edge guides. Otherwise, the carrier sheet may be fed skewed.

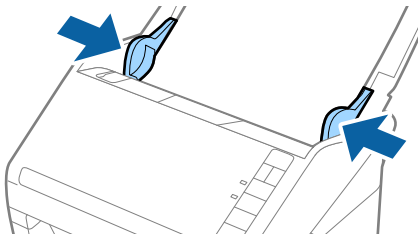

Note:

- ❑ You may need to stop using a Carrier Sheet that is scratched or has been scanned more than 3,000 times.
- ❑ If you cannot find an appropriate size for the original you want to scan in the **Document Size** list in Epson Scan 2, select **Auto Detect** or select **Customize** to create a custom document size.
When scanning a Carrier Sheet by selecting **Auto Detect** as the **Document Size** setting, the image is automatically scanned by applying **Paper Skew** in the **Correct Document Skew** setting.
- ❑ Only use the Carrier Sheet designed for your scanner. The Carrier Sheet is automatically recognized by the scanner by detecting two small rectangular holes on the front edge. Keep the holes clean and not covered.

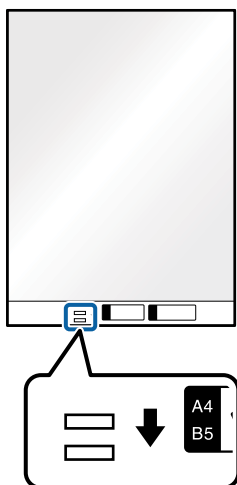

Related Information

- ➔ [“Carrier Sheet Codes” on page 27](#)
- ➔ [“Required Settings for Special Originals in Epson Scan 2 Window” on page 72](#)

Photographs

Specifications of Photographs

By using the Carrier Sheet sold separately, you can scan photographs without worrying about them being damaged.

Size	Thickness	Loading Capacity of the Carrier Sheet
Up to A4	0.3 mm (0.012 in.) or less (excluding the thickness of the Carrier Sheet)	5 sheets

Placing Photographs

1. Open the input tray and extend the input tray extension. Slide out the output tray, extend the output tray extension, and then raise the stopper.

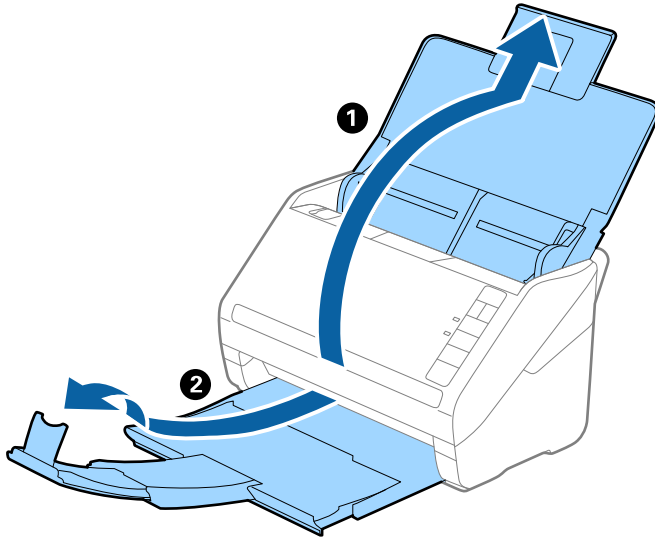

2. Slide the edge guides on the input tray all the way out.

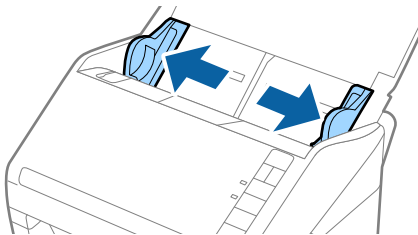

3. Place the Carrier Sheet with the illustration on the front edge facing up and place the photo in the center of the Carrier Sheet with the side to be scanned facing down.

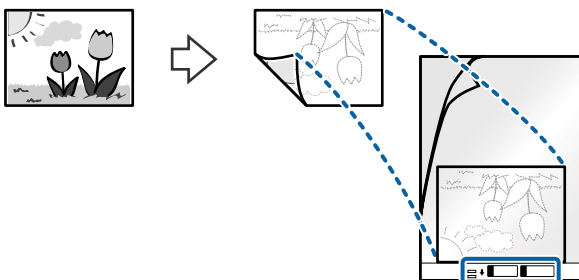

4. Load the Carrier Sheet into the input tray with the top edge facing into the ADF.
Slide the Carrier Sheet into the ADF until it meets resistance.

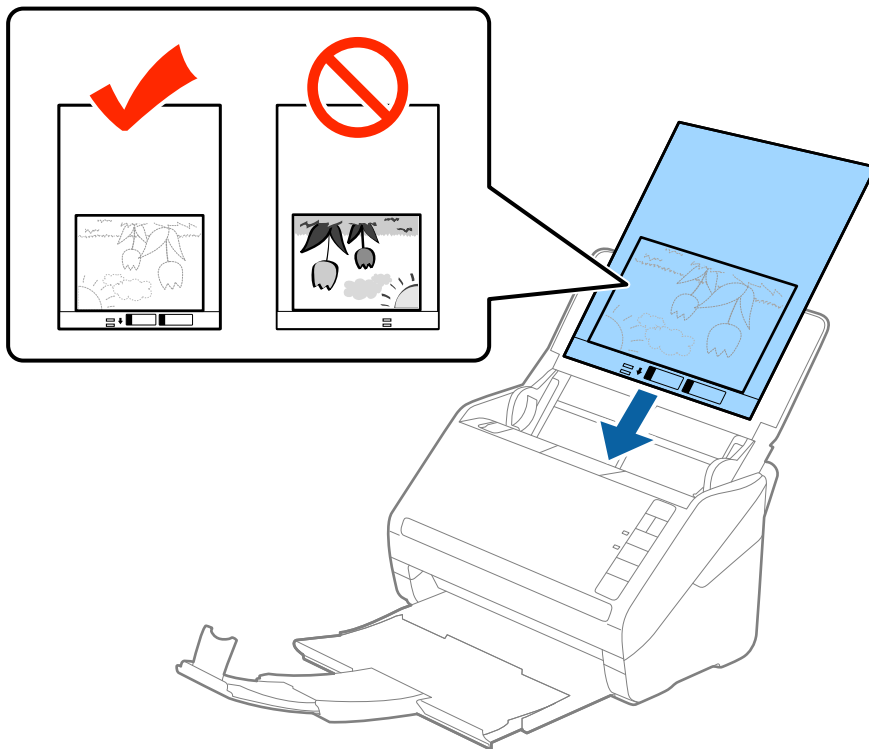

5. Slide the edge guides to fit the edge of the Carrier Sheet making sure there are no gaps between the Carrier Sheet and the edge guides. Otherwise, the carrier sheet may be fed skewed.

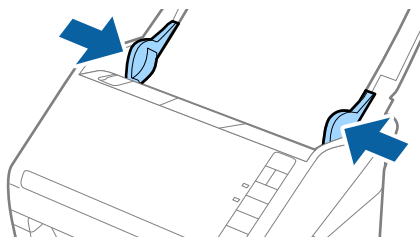

Note:

- ❑ You may need to stop using a Carrier Sheet that is scratched or has been scanned more than 3,000 times.
- ❑ If you cannot find an appropriate size for the original you want to scan in the **Document Size** list in Epson Scan 2, select **Auto Detect** or select **Customize** to create a custom document size.
When scanning a Carrier Sheet by selecting **Auto Detect** as the **Document Size** setting, the image is automatically scanned by applying **Paper Skew** in the **Correct Document Skew** setting.
- ❑ Do not leave photos inside the Carrier Sheet for a long time.
- ❑ Only use the Carrier Sheet designed for your scanner. The Carrier Sheet is automatically recognized by the scanner by detecting two small rectangular holes on the front edge. Keep the holes clean and not covered.

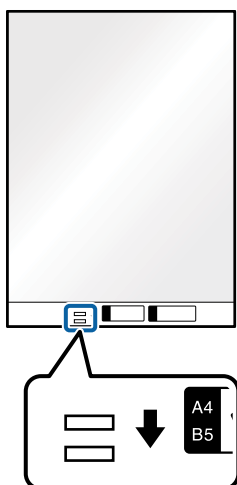

Related Information

- ➔ [“Carrier Sheet Codes” on page 27](#)
- ➔ [“Required Settings for Special Originals in Epson Scan 2 Window” on page 72](#)

Envelopes

Specifications of Envelopes

The specification of envelopes you can load into the scanner.

Size	Measurement	Thickness	Loading Capacity
C6	114×162 mm (4.49×6.38 in.) (standard size)	0.38 mm (0.015 in.) or less	5 envelopes
DL	110×220 mm (4.33×8.66 in.) (standard size)		

Placing Envelopes

1. Open the input tray and extend the input tray extension. Slide out the output tray, extend the output tray extension, and then raise the stopper.

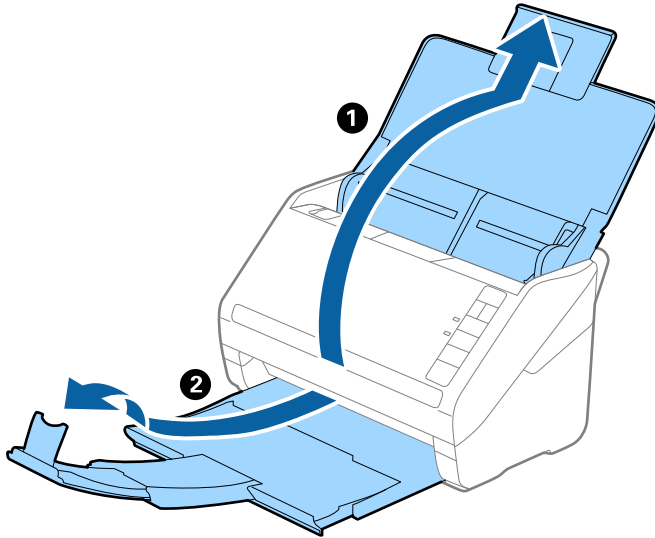

2. Slide the edge guides on the input tray all the way out.

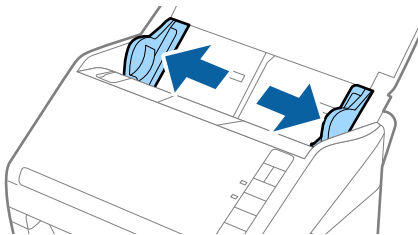

3. Load the envelopes into the input tray facing down making sure that the opened edge (flap side) of the envelope is facing to the side. For envelopes with the opened edge (flap side) on the shorter side, you can load the envelope with the opened edge (flap side) facing up.

Slide the envelopes into the ADF until they meet resistance.

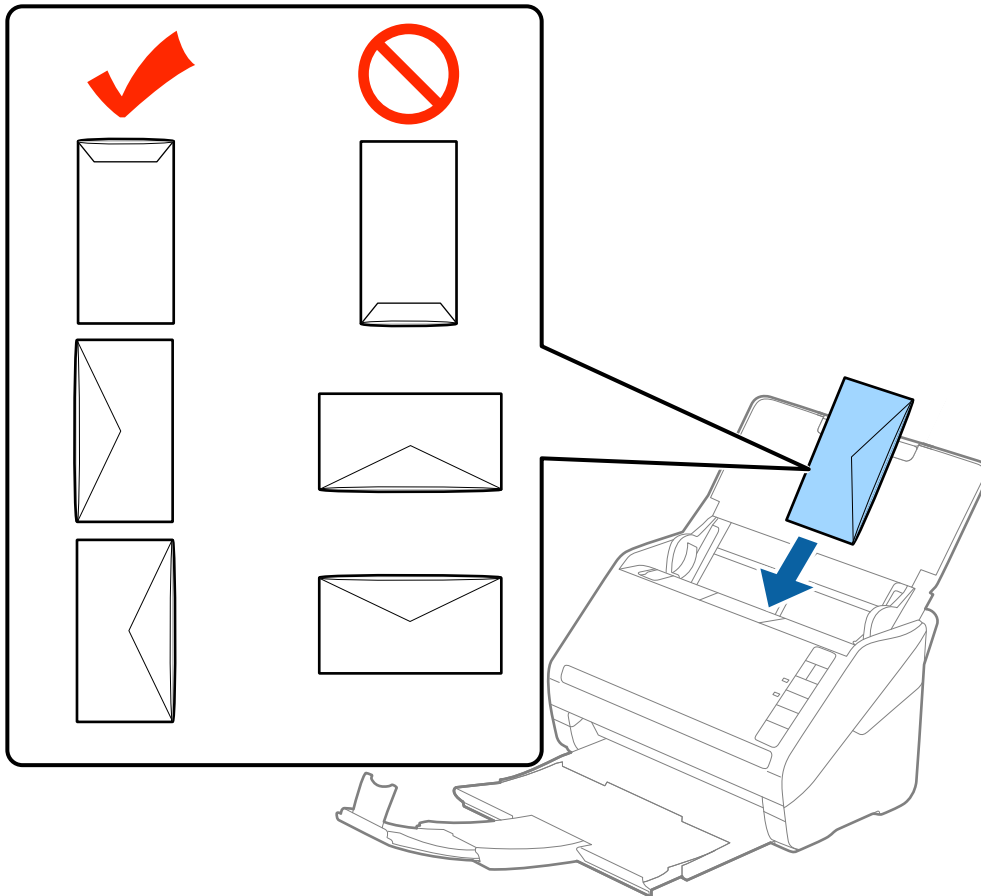

! **Important:**

Do not load envelopes with adhesives on them.

Note:

- Envelopes that are not opened by cutting sharply at the flap edge may not be scanned correctly.*
- Envelopes that have not yet been sealed can be loaded with the flap open and facing up.*

4. Slide the edge guides to fit the edge of the envelopes making sure there are no gaps between the envelopes and the edge guides. Otherwise, the envelopes may be fed skewed.

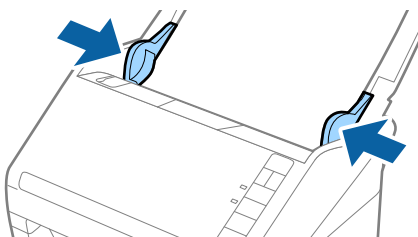



Note:

- ❑ To scan envelopes, we recommend selecting the appropriate rotation angle or **Auto** in **Rotate** on the **Main Settings** tab in the Epson Scan 2 window before scanning. See the Epson Scan 2 help for details.
- ❑ To scan envelopes, set the appropriate setting in the Epson Scan 2 window.

When you are using Epson ScanSmart, you can open the Epson Scan 2 window by pressing the **Settings** button > **Scanner Settings** tab > **Scan Settings**.

Select **Off** in **Detect Double Feed** on the **Main Settings** tab. See the Epson Scan 2 help for details.

If you forget to disable **Detect Double Feed** in Epson Scan 2 and a double feed error occurs, remove the envelope from the ADF and then reload it, press the  (Double Feed Detection Skip) button on the scanner as shown below to disable **Detect Double Feed** for the next scan, and then scan again. The  (Double Feed Detection Skip) button only disables **Detect Double Feed** for one sheet.

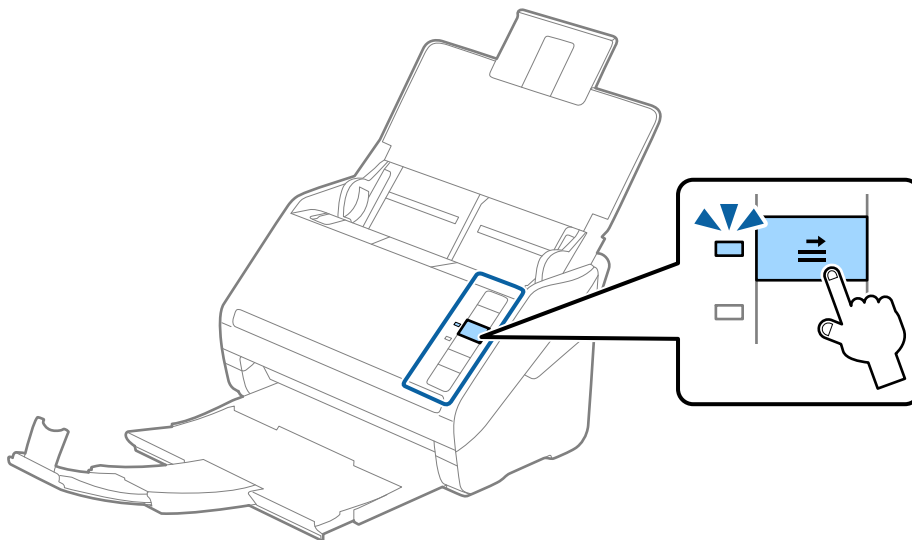

Related Information

➔ [“Required Settings for Special Originals in Epson Scan 2 Window” on page 72](#)

Mixture of Originals

Specifications of Originals that are a Mixture of Different Sizes

You can load a mixture of originals from 50.8×50.8 mm (2.0×2.0 in.) to A4 (or Letter) size. You can also load a mixture of paper types or thickness.

 **Important:**

- ❑ When placing and scanning originals that are a mixture of different sizes, originals may be fed askew because not all of the originals are supported by edge guides.
- ❑ Originals may be jammed or fed askew if you set different types or very different sizes of originals, such as in the following cases.

- Thin paper and Thick paper
- A4 size paper and card size paper

If originals are fed askew, check whether or not the scanned image is available.

Note:

- ❑ If originals are jammed or are not fed correctly, enabling **Slow mode** may improve feeding.
- ❑ Alternatively, you can scan originals of different paper sizes and types by loading them one by one using **Automatic Feeding Mode**.

Placing a Mixture of Originals at Different Sizes

1. Open the input tray and extend the input tray extension. Slide out the output tray, extend the output tray extension, and then raise the stopper.

Note:

If there are any thick originals amongst the originals, to stop the thick originals from bumping into the output tray and falling out, store the output tray and do not use it to stack the ejected originals.

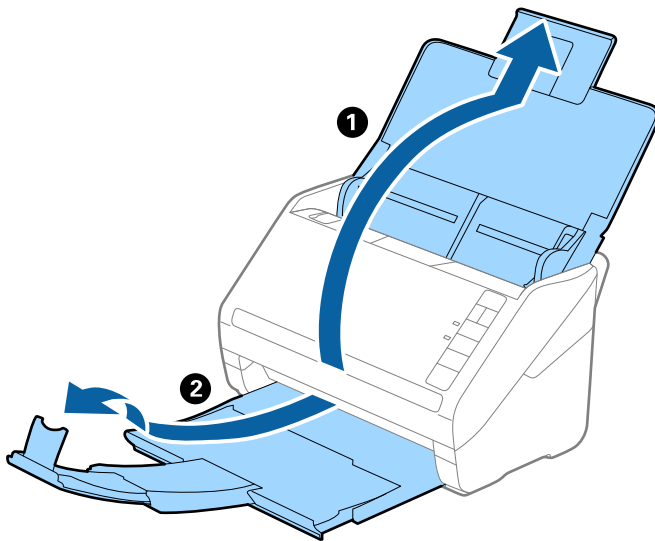

2. Slide the edge guides on the input tray all the way out.

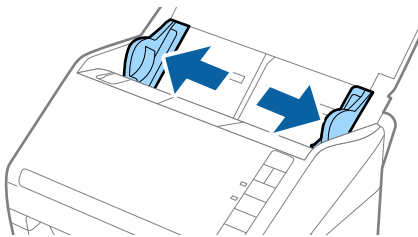

3. Load the originals at the center of the input tray in descending order of paper size with the widest at the back and the narrowest at the front.

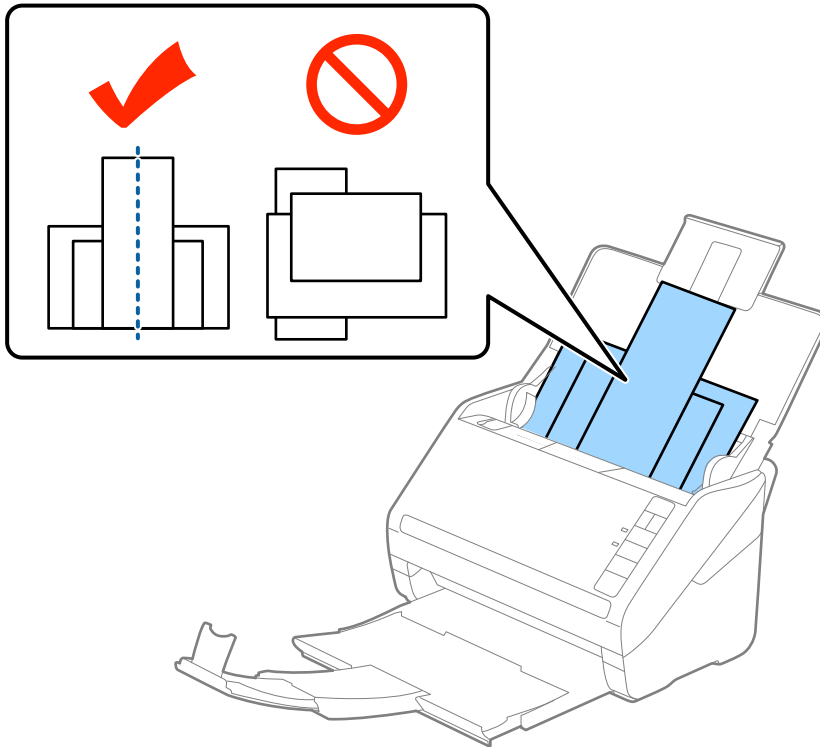

Note:

- Load the originals into the input tray facing down and slightly displace the top edges at an angle facing into the ADF.
- Slide the originals into the ADF until they meet resistance.
- You can stack the originals up to 8 mm (0.31 in.).

4. Slide the edge guides to fit the edges of the widest original.

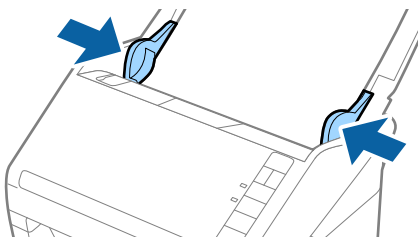

Related Information

➔ [“Scanning Different Sizes or Types of Originals One by One Continuously \(Automatic Feeding Mode\)” on page 73](#)

You can scan different sizes or types of originals one by one using Automatic Feeding Mode. In this mode, the scanner starts scanning automatically when originals are loaded into the scanner.

Network Settings

Network Connection Types.	64
Connecting the Scanner to the Network.	65
Making Wi-Fi Settings from the Control Panel.	65
Checking the Scanner's IP Address.	67

Network Connection Types

You can use the following connection methods.

Wi-Fi Connection

Connect the scanner and the computer or smart device to the wireless router. This is the typical connection method for home or office networks where computers are connected by Wi-Fi through the wireless router.

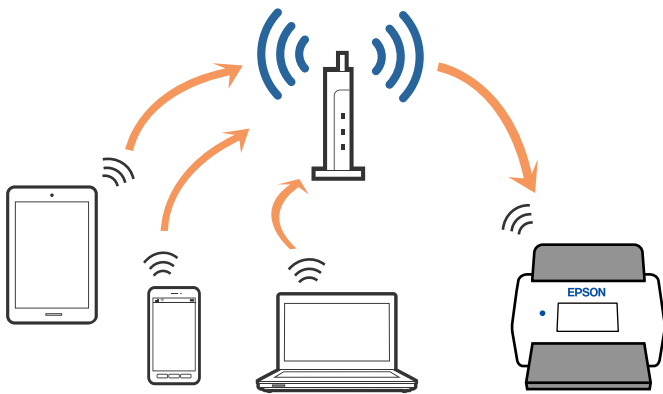

AP Mode Connection

Use this connection method when you are not using Wi-Fi at home or at the office, or when you want to connect the scanner and the smart device directly. In this mode, the scanner acts as an access point and you can connect up to four devices to the scanner without having to use a standard access point. However, devices directly connected to the scanner cannot communicate with each other through the scanner.

Note:

AP mode is a connection method designed to replace Ad Hoc mode.

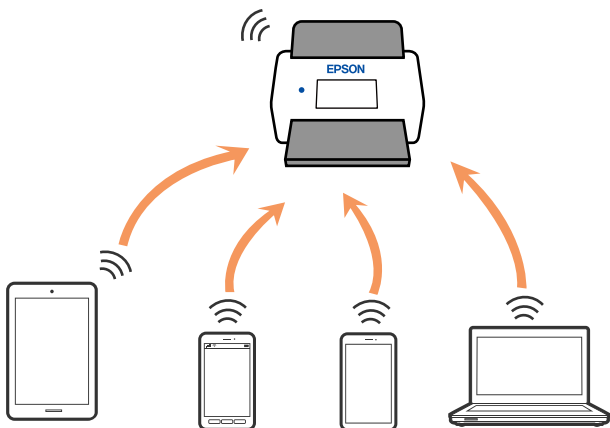

The scanner can be connected by Wi-Fi and AP mode simultaneously. However, if you start a network connection in AP mode when the scanner is connected by Wi-Fi, the Wi-Fi is temporarily disconnected.

Connecting the Scanner to the Network

If the scanner is not connected to the network, use the installer to connect the scanner to the network.

You can use any of the following methods to start the installer.

- Setting up from the website

Access the following website, and then enter the product name. Go to **Setup**, and then start setting up.

<http://epson.sn>

- Setting up using the software disc (only for models that come with a software disc and users with Windows computers with disc drives.)

Insert the software disc into the computer, and then follow the on-screen instructions.

If you want to check the network connection or connect to the network manually, see the related information.

Related Information

- ➔ [“Lights” on page 21](#)
- ➔ [“Error Indicators” on page 22](#)
- ➔ [“Connecting to the Network” on page 125](#)

Making Wi-Fi Settings from the Control Panel

You can make network settings from the scanner's control panel. After connecting the scanner to the network, connect to the scanner from the device that you want to use (computer, smart phone, tablet, and so on.)

Making Wi-Fi Settings by Push Button Setup (WPS)

You can automatically set up a Wi-Fi network by pressing a button on the access point. If the following conditions are met, you can set up by using this method.

- The access point is compatible with WPS (Wi-Fi Protected Setup).
- The current Wi-Fi connection was established by pressing a button on the access point.



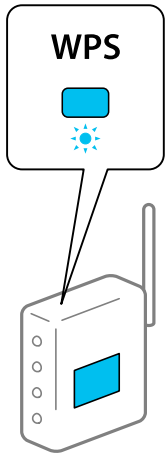

Note:

If you cannot find the button or you are setting up using the software, see the documentation provided with the access point.



1. Hold down the [WPS] button on the access point until the security light flashes.



If you do not know where the [WPS] button is, or there are no buttons on the access point, see the documentation provided with your access point for details.



2. Press the  button on the scanner's control panel until the  light flashes blue (approximately 3 seconds).
The connection setting starts. The  light and  light flash alternately.
The  light is lit blue when connection is complete.

Note:

Connection fails when the  light turns on. After releasing the error by pressing the  button, restart the access point, move it closer to the scanner, and then try again.

Making Wi-Fi Settings by PIN Code Setup (WPS)

You can automatically connect to an access point by using a PIN code. You can use this method to set up if an access point is capable of WPS (Wi-Fi Protected Setup). Use a computer to enter a PIN code into the access point.



1. Press the  button and the  button on the scanner's control panel simultaneously until  light flashes in blue (approximately 3 seconds).
2. Use your computer to enter the PIN code (an eight-digit number) on the label stuck to the scanner into the access point within two minutes.

The connection setting starts. The  light and  light flash alternately.

The  is lit blue when connection is complete.

Note:

See the manual provided with your access point for details on entering a PIN code.



Connection fails when the  light turns on. After releasing the error by pressing the  button, restart the access point, move it closer to the scanner, and then try again.

Making AP Mode Settings

This method allows you to connect the scanner directly to devices without an access point. The scanner acts as an access point.

 **Important:**

When you connect from a smart device to the scanner using the AP mode connection, the scanner is connected to the same Wi-Fi network (SSID) as the smart device and communication is established between them. Since the smart device is automatically connected to other connectable Wi-Fi networks if the scanner is turned off, it is not connected to the previous Wi-Fi network again if the scanner is turned on. Connect to the scanner's SSID in AP mode from the smart device again. If you do not want to connect every time you turn the scanner on or off, we recommend using a Wi-Fi network by connecting the scanner to an access point.

1. Press the  button on the scanner's control panel.
The  light is lit blue when AP mode connection is enabled.
2. Connect from the smart device or computer to the scanner using the scanner's SSID and password.

Note:

- You can check the SSID and password on the label stuck to the scanner.
- See the documentation provided with your smart device or computer for the operating instructions.

Checking the Scanner's IP Address

You can check the scanner's IP address in Epson Scan 2 Utility.

Note:

You need to connect the computer to the same wireless router as the scanner before checking the IP address.

1. Start Epson Scan 2 Utility.
 - Windows 10
Click the start button, and then select **EPSON > Epson Scan 2 Utility**.
 - Windows 8.1/Windows 8
Enter the application name in the search charm, and then select the displayed icon.
 - Windows 7/Windows Vista/Windows XP
Click the start button, and then select **All Programs** or **Programs > EPSON > Epson Scan 2 > Epson Scan 2 Utility**.
 - Mac OS
Select **Go > Applications > Epson Software > Epson Scan 2 Utility**.
2. Click **Settings** from the **Scanner** pull-down menu.
3. Click **Add**.
4. Select the scanner for which you want to check the IP address from the **Model** pull-down menu.

The IP address of the selected scanner is displayed in the address list.

Scanning

Scanning from a Computer.	69
Scanning from Smart Device (Epson Smart Panel).	75

Scanning from a Computer

Scanning Using Epson ScanSmart

Use the scanning application Epson ScanSmart to scan.

This application allows you to scan documents easily, and then save the scanned images in simple steps. See the Epson ScanSmart help for details on how to use the application. This section explains how to scan and save to a PDF file as a basic step.

1. Place the originals on your scanner.
2. Start Epson ScanSmart.
 - Windows 10
Click the start button, and then select **Epson Software > Epson ScanSmart**.
 - Windows 8.1/Windows 8
Enter the application name in the search charm, and then select the displayed icon.
 - Windows 7
Click the start button, and then select **All Programs > Epson Software > Epson ScanSmart**.
 - Mac OS
Open the **Applications** folder and select **Epson ScanSmart**.
3. Click **Scan double-sided** or **Scan single-sided**.

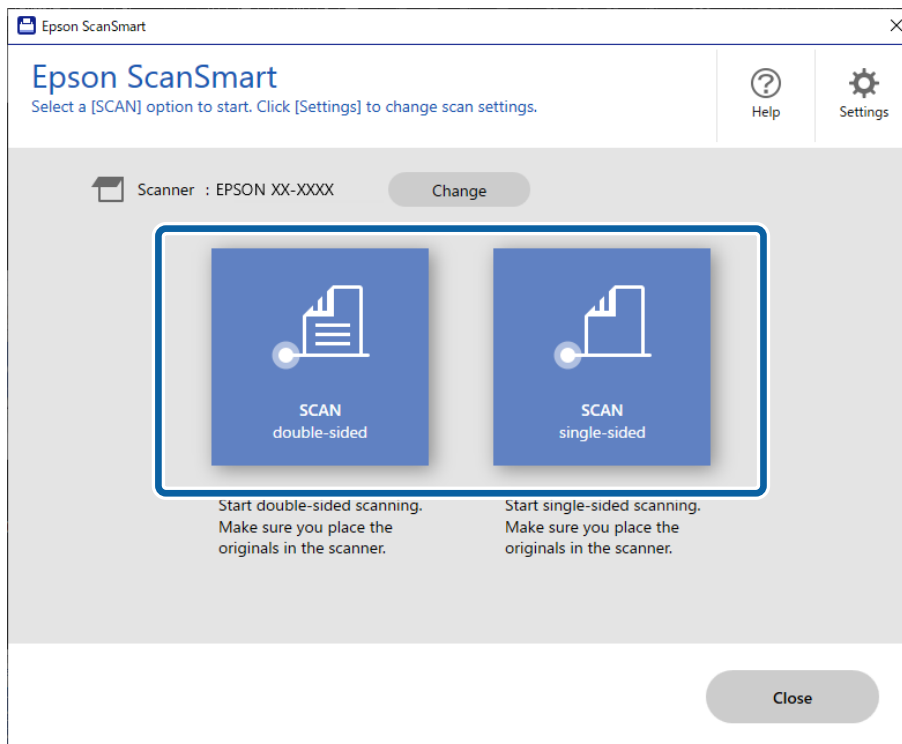

Scanning starts automatically.

4. Check the scanned images, and organize them if necessary.

- ① You can add originals and scan them by clicking **Scan**.
- ② You can use the buttons at the top of the screen to rotate scanned images.
- ③ You can choose to keep or discard the back sides of double-sided scanned images from **Include back sides**.
- ④ If you do not want to check scanned images each time, select **Skip this screen next time**.

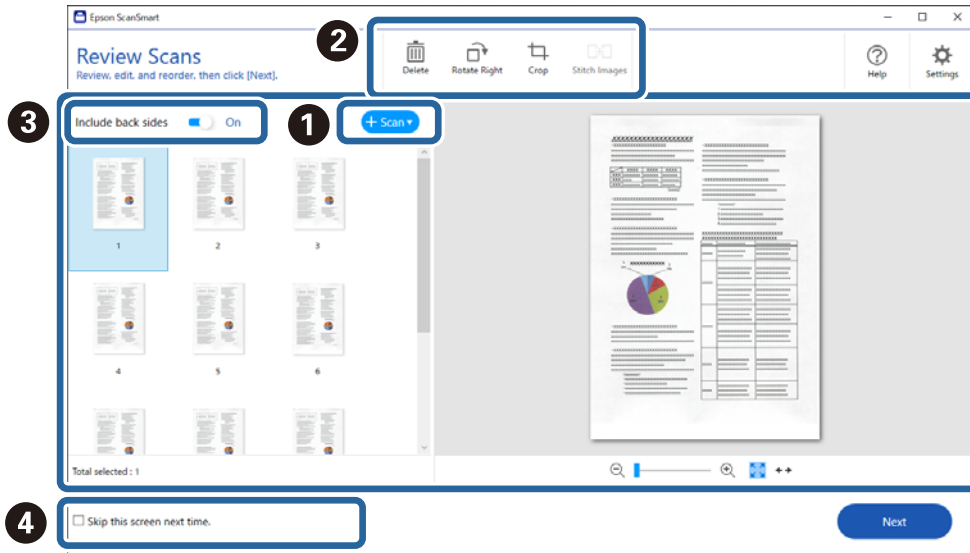

5. Click **Next**.

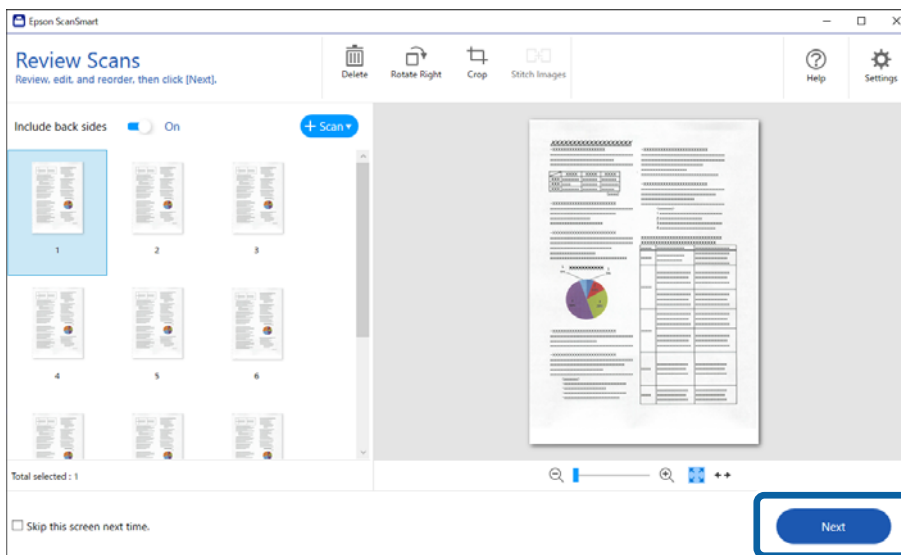

6. On the **Select Action** screen, click **Save**.

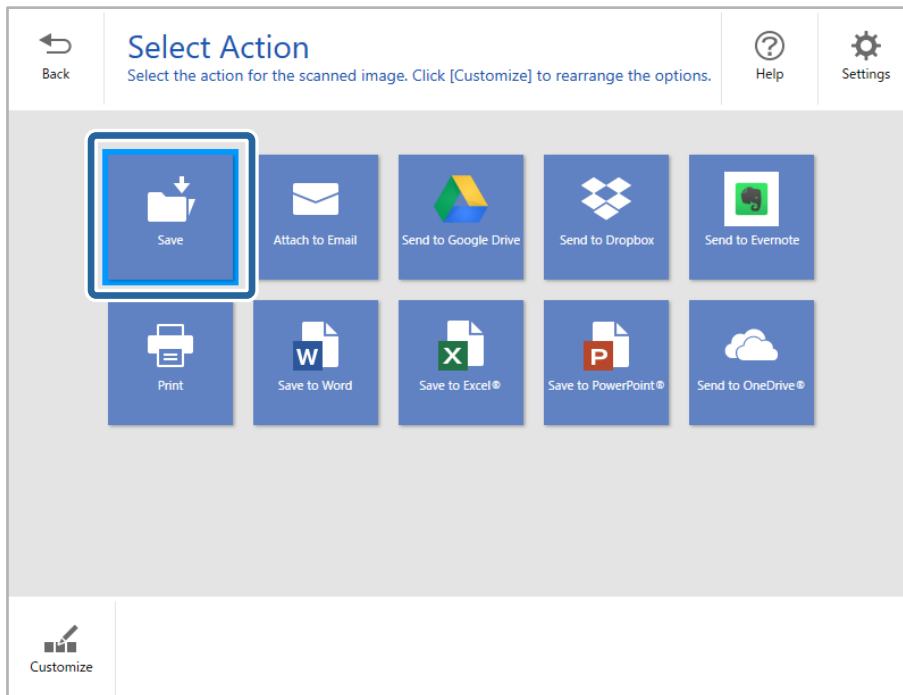

7. Check or change the save settings as necessary.

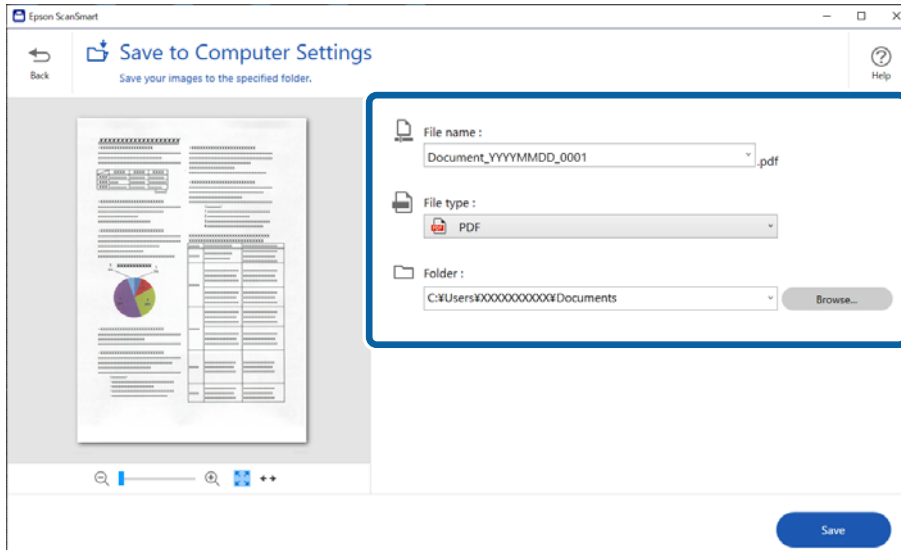

8. Click **Save**.

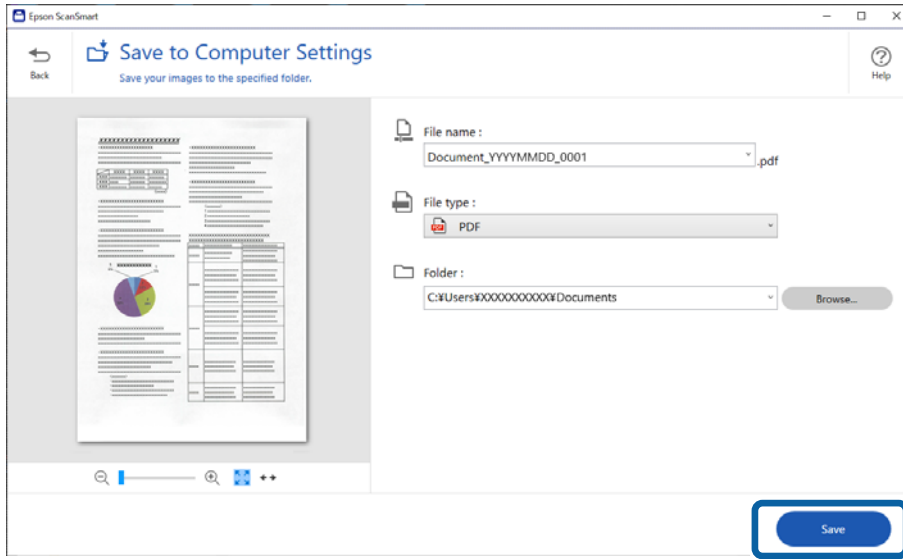

The scanned image is saved to the specified folder.

Required Settings for Special Originals in Epson Scan 2 Window

You need to set certain items on the **Main Settings** tab in Epson Scan 2 window when scanning special originals.

When you are using Epson ScanSmart, you can open the window by pressing the  **Settings** button > **Scanner Settings** tab > **Scan Settings**.

Type of Original	Required Settings
Envelopes	Select Off in Detect Double Feed .
Plastic cards	Select Plastic Card on the Document Size list, or select Off in Detect Double Feed .
Carrier Sheet	<ul style="list-style-type: none"> <input type="checkbox"/> If you select Auto Detect from the Document Size list, paper skew in the original is automatically corrected even if you select Off in Correct Document Skew. <input type="checkbox"/> If you select a other size than Auto Detect from the Document Size list, you can only use Contents Skew when using Correct Document Skew. <p>Paper Skew is not applied when this is selected. When you select Paper and Contents Skew, only contents skew is corrected.</p>
Large size originals	If the size of the original you want to scan is not on the Document Size list, select Customize to open the Document Size Settings window. Next, create the size manually on the window.
Long paper	If the size is not listed on the Document Size list, select Auto Detect (Long Paper) or select Customize to create a custom document size.
Laminated cards	To scan transparent areas around the edges, select Customize on the Document Size list to open the Document Size Settings window. Next, select Scan laminated card in the window.
	<p>Note:</p> <p><i>The appropriate effect may not be achieved depending on the original. If transparent areas around the edges are not scanned, select Customize from the Document Size list, and then create the size manually.</i></p>

Related Information

➔ [“Placing Originals” on page 35](#)

Scanning Different Sizes or Types of Originals One by One Continuously (Automatic Feeding Mode)

You can scan different sizes or types of originals one by one using Automatic Feeding Mode. In this mode, the scanner starts scanning automatically when originals are loaded into the scanner.

1. Start Epson ScanSmart.
2. Click  **Settings**.
3. Click **Scan Settings** on the **Scanner Settings** tab.

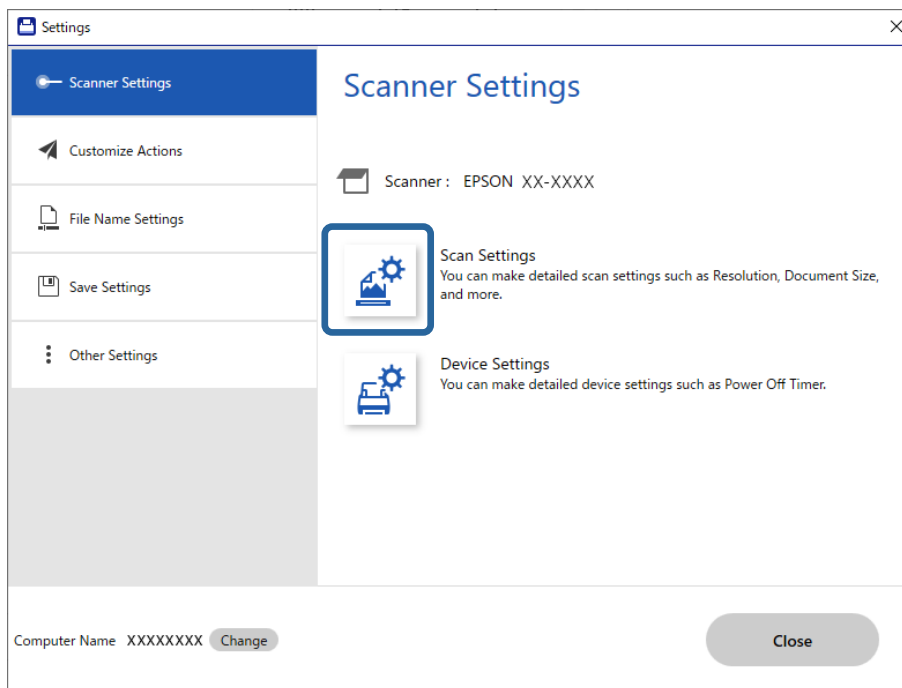

The **Epson Scan 2** window is displayed.

4. Select **Automatic Feeding Mode** on the **Main Settings** tab.

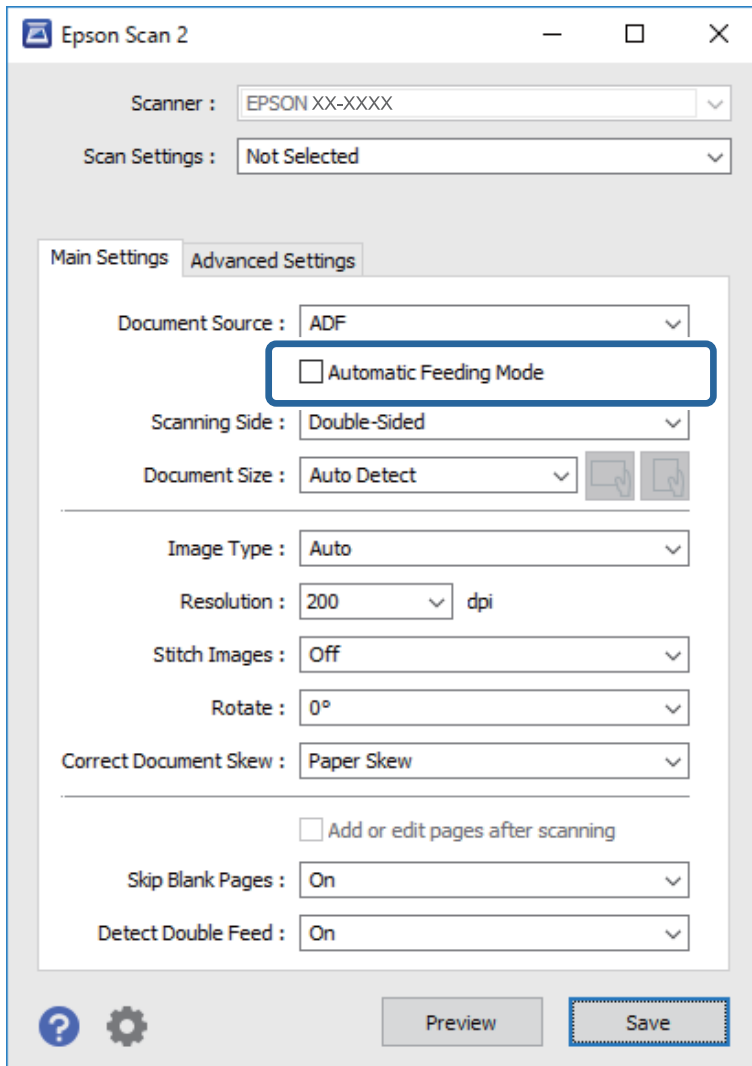

5. Make other settings for scanning on the Epson Scan 2 window.

Note:

You can make timeout settings to finish **Automatic Feeding Mode**.



Select **Settings** on the **Document Source** list to open the **Document Source Settings** window. Set **Automatic Feeding Mode Timeout (seconds)** on the window.

6. Click **Save** to close the Epson Scan 2 window.
7. Click **Close** to close the **Settings** window.
8. Click **Scan double-sided** or **Scan single-sided**.
Automatic Feeding Mode starts.
9. Adjust the edge guides, and then place the original in the ADF.
Scanning starts automatically.

10. After scanning stops, place the next original in the ADF.

Repeat this procedure until you have scanned all originals.

Note:

- If you want to scan originals that are detected as double feeds, for example plastic cards or envelopes, press the  (Double Feed Detection Skip) button before placing the original to skip double feed detection.
- If you want to scan originals that are likely to jam, for example thin paper, press the  (Slow Mode) button before placing the original to slow down the scanning speed.

11. After you have scanned all originals, exit Automatic Feeding Mode.

Click **Finish** on the **Automatic Feeding Mode** window displayed on your computer.

Follow the instructions of the Epson ScanSmart to save the scanned image.

Scanning from Smart Device (Epson Smart Panel)

To scan from your smart device, search for and install Epson Smart Panel from App Store or Google Play.

Note:

Connect the scanner to the smart device before scanning.

1. Place the original.
2. Start Epson Smart Panel.
3. Follow the on-screen instructions to scan.

The scanned image is saved to your smart device, send to cloud service, or send to email.

Useful Features

Setting the Glass Surface Stain Detection Feature.	77
Setting the Document Protection Feature.	78
Setting the Operation When a Double-Feed is Detected.	79

Setting the Glass Surface Stain Detection Feature

Vertical lines may appear in the image due to dust or dirt on the glass surface inside the scanner.

When **Detect Glass Dirt** is set to On, the scanner detects any stains on the glass surface inside the scanner and displays a notification on your computer screen.

When this notification is displayed, clean the glass surface inside the scanner with the dedicated cleaning kit or a soft cloth.

The default setting is **Off**.

1. Start Epson Scan 2 Utility.

- Windows 10

Click the start button, and then select **EPSON - Epson Scan 2 Utility**.

- Windows 8.1/Windows 8

Enter the software name in the search charm, and then select the icon displayed.

- Windows 7/Windows Vista/Windows XP

Click the start button, and then select **All Programs** or **Programs - EPSON - Epson Scan 2 - Epson Scan 2 Utility**.

- Mac OS

Select **Go - Applications - Epson Software - Epson Scan 2 Utility**.

2. Make the following settings on the **Scanner Setting** tab.

Set **Detect Glass Dirt** to **On-Low** or **On-High**.

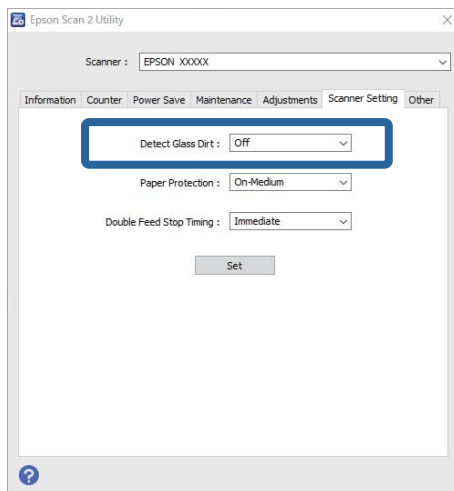

Note:

- Some stains may not be detected correctly.

- If detection does not work correctly, try changing the settings.

If no stains are detected, select **On-High**. If stains are detected incorrectly, select **On-Low** or **Off**.

3. Select **Set** to apply the settings to the scanner.

Setting the Document Protection Feature

To reduce damage to the document, scanning stops immediately when the following conditions are detected.

- A paper feed error has occurred
- A document is fed at an angle

The default setting is **On-Medium**.



Important:

- This feature does not prevent all documents from being damaged.*
- Paper feed errors may not be detected depending on the paper feeding conditions.*

1. Start Epson Scan 2 Utility.

- Windows 10

Click the start button, and then select **EPSON - Epson Scan 2 Utility**.

- Windows 8.1/Windows 8

Enter the software name in the search charm, and then select the icon displayed.

- Windows 7/Windows Vista/Windows XP

Click the start button, and then select **All Programs** or **Programs - EPSON - Epson Scan 2 - Epson Scan 2 Utility**.

- Mac OS

Select **Go - Applications - Epson Software - Epson Scan 2 Utility**.

2. Make the following settings on the **Scanner Setting** tab.

Set **Paper Protection** to **On-Low**, **On-Medium** or **On-High**.

To enable this feature, select the level of detection you want to use. See the following table for details on each level.

Level	Description
On-Low	Lower the sensitivity to detect the skew of the originals.
On-Medium	Detect the skew of the stapled originals and the skew that On-Low could not detect.

Level	Description
On-High	Increase the sensitivity to detect the skew of the originals.

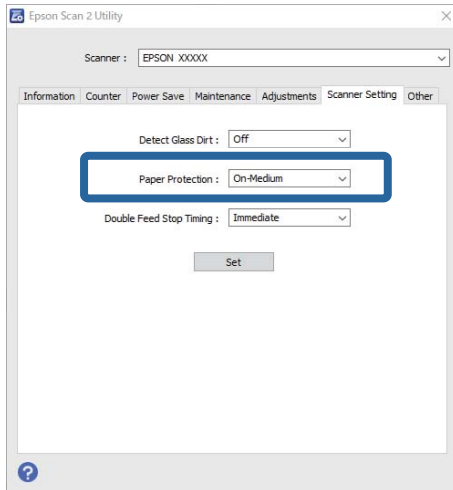

Note:

- This feature may not work correctly depending on the document, the paper feeding conditions, and the level set.
- When scanning plastic cards and cardboard, select **Off** to disable this feature.
- If false positives occur frequently, try lowering the level.
- If the document is an irregular shape or is scanned at an angle, it may be mistakenly detected as a paper feed error.
- When inserting multiple documents, make sure that the leading edges of the documents are aligned. If the leading edges of the documents are not aligned, they may be mistakenly detected as a paper feed error even if they are scanned correctly.
- Make sure you align the document guides with the document to avoid scanning it at an angle.

3. Select **Set** to apply the settings to the scanner.

Setting the Operation When a Double-Feed is Detected

Set the stop timing when a double-feed of documents is detected.

- Immediate:** Stops as soon as a double-feed is detected.
- After Eject:** The documents for which a double-feed is detected are scanned as they are, but scanning of the next document is stopped.

When you are satisfied that there are no problems in the scanned image, you can continue scanning.

The default setting is **Immediate**.

1. Start Epson Scan 2 Utility.

- Windows 10

Click the start button, and then select **EPSON - Epson Scan 2 Utility**.

- ❑ Windows 8.1/Windows 8

Enter the software name in the search charm, and then select the icon displayed.

- ❑ Windows 7/Windows Vista/Windows XP

Click the start button, and then select **All Programs** or **Programs - EPSON - Epson Scan 2 - Epson Scan 2 Utility**.

- ❑ Mac OS

Select **Go - Applications - Epson Software - Epson Scan 2 Utility**.

2. Make the following settings on the **Scanner Setting** tab.

Set **Double Feed Stop Timing** to **Immediate** or **After Eject**.

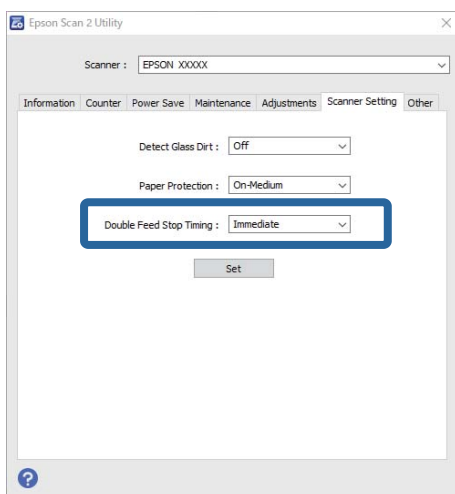

3. Select **Set** to apply the settings to the scanner.

Maintenance

Cleaning Outside the Scanner.	82
Cleaning Inside the Scanner.	82
Replacing the Roller Assembly Kit.	88
Energy Saving.	94
Transporting the Scanner.	95
Updating Applications and Firmware.	95

Cleaning Outside the Scanner

Wipe off any stains on the outer case with a dry cloth or a cloth dampened with mild detergent and water.



Important:

- Never use alcohol, thinner, or any corrosive solvent to clean the scanner. Deformation or discoloration may occur.
- Do not let water get inside the product. This could cause a malfunction to occur.
- Never open the scanner case.

1. Press the  button to turn off the scanner.
2. Unplug the AC adapter from the scanner.
3. Clean the outer case with a cloth dampened with mild detergent and water.

Cleaning Inside the Scanner

After using the scanner for a while, paper and room dust on the roller or the glass part inside the scanner may cause paper feed or scanned image quality problems. Clean the inside of the scanner every 5,000 scans.

You can check the latest number of scans in the Epson Scan 2 Utility.

If a surface is stained with a hard-to-remove material, use a genuine Epson cleaning kit to remove stains. Use a small amount of cleaner on the cleaning cloth to remove the stains.



Important:

- Never use alcohol, thinner, or any corrosive solvent to clean the scanner. Deformation or discoloration may occur.
- Never spray any liquid or lubricant on the scanner. Damage to equipment or circuits may cause abnormal operations.
- Never open the scanner case.

1. Press the  button to turn off the scanner.
2. Unplug the AC adapter from the scanner.

3. Pull the cover open lever and open the scanner cover.

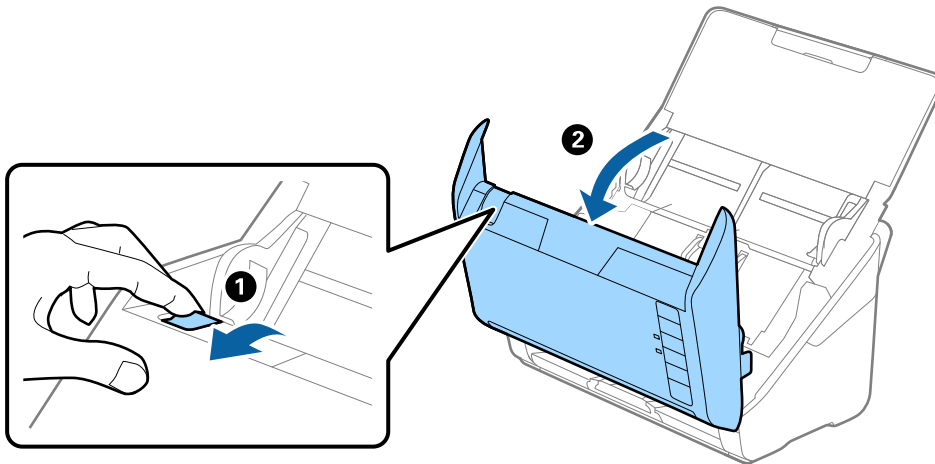

4. Wipe off any stains on the plastic roller and glass surface at the bottom inside of the scanner cover using a soft cloth or a genuine Epson cleaning kit.

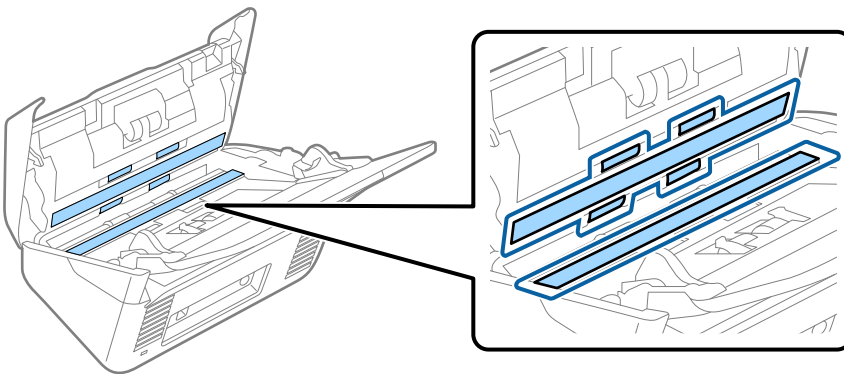

! Important:

- Do not place too much force on the glass surface.
- Do not use a brush or a hard tool. Any scratches on the glass may affect the scan quality.
- Do not spray cleaner directly onto the glass surface.

5. Wipe off any stains on the sensors with a cotton swab.

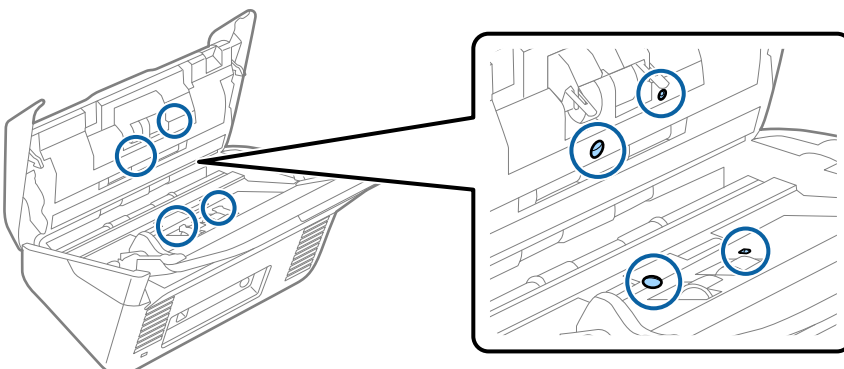

! **Important:**

Do not use liquid such as a cleaner on a cotton swab.

6. Open the cover, and then remove the separation roller.
See “Replacing the Roller Assembly Kit” for more details.

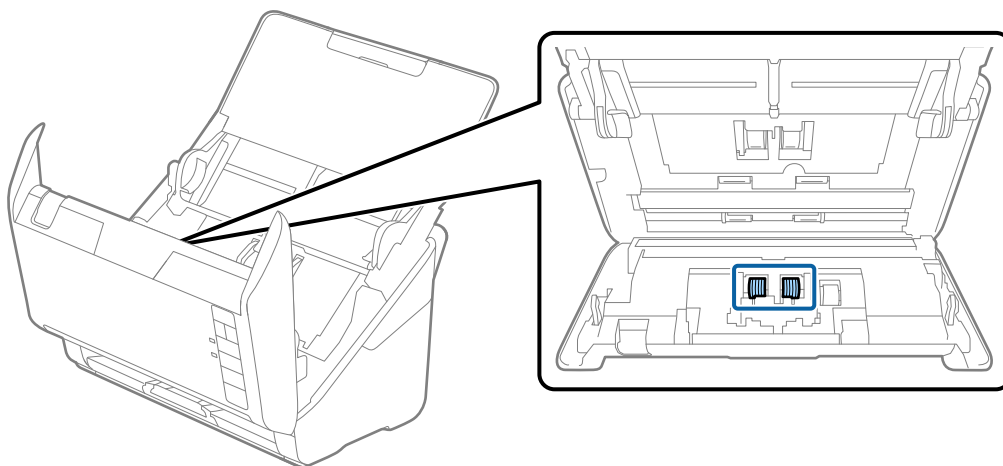

7. Wipe off any dust or dirt on the separation roller using a genuine Epson cleaning kit or a soft, moist cloth.

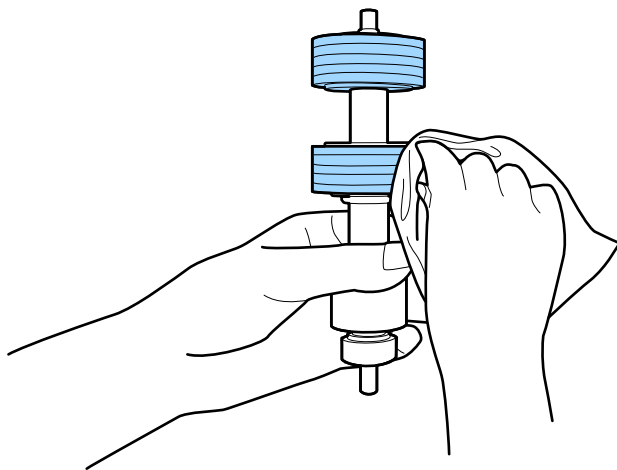

! **Important:**

Use only a genuine Epson cleaning kit or a soft, moist cloth to clean the roller. Using a dry cloth may damage the surface of the roller.

8. Open the cover, and then remove the pickup roller.
See “Replacing the Roller Assembly Kit” for more details.

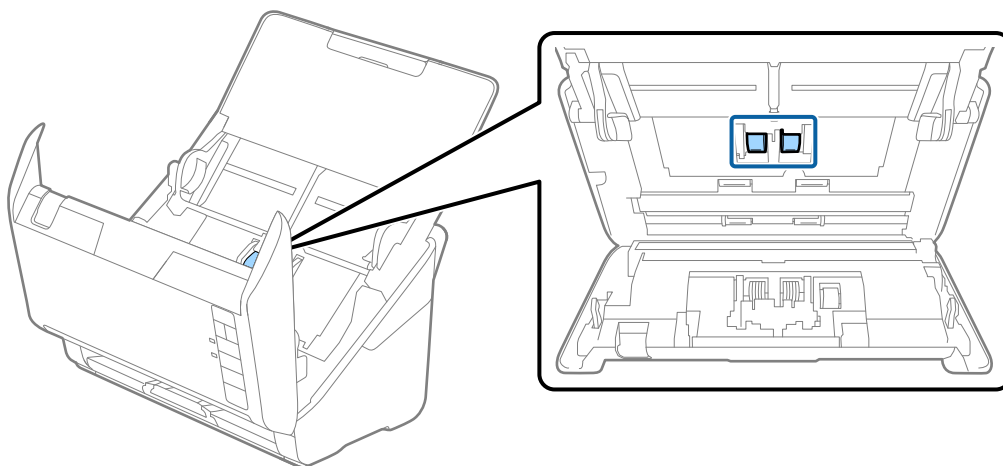

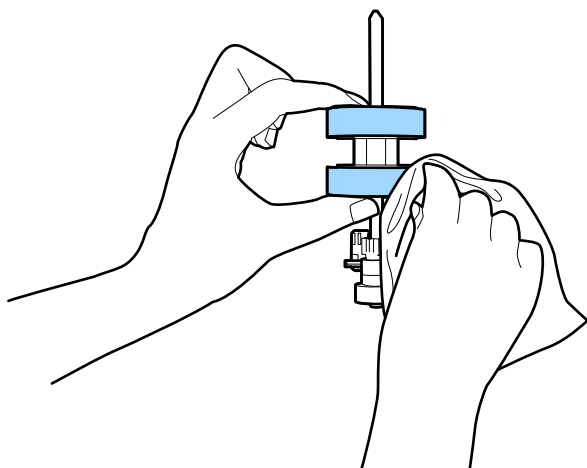

9. Wipe off any dust or dirt on the pickup roller using a genuine Epson cleaning kit or a soft, moist cloth.



Important:

Use only a genuine Epson cleaning kit or a soft, moist cloth to clean the roller. Using a dry cloth may damage the surface of the roller.

10. Plug in the AC adapter, and then turn on the scanner.

11. Hold down the  button for at least two seconds while opening the scanner cover. The rollers on the bottom move momentarily, and then the scanner enters cleaning mode. The rollers rotate a bit each time you press the  button. Press the  button several times to rotate the rollers. Use a genuine Epson cleaning kit or a soft, moist cloth to clean the rollers as they rotate. Repeat this step until the rollers are clean.

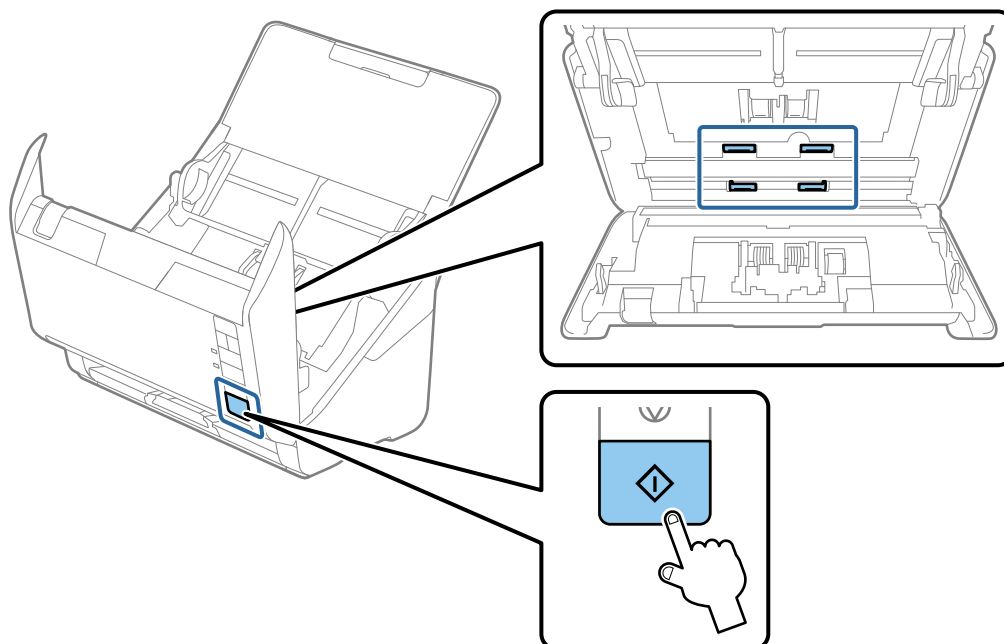

Caution:

Be careful not to get your hands or hair caught in the mechanism when operating the roller. This could cause an injury.

12. Close the scanner cover.
The scanner exits cleaning mode.

Related Information

- ➔ [“Cleaning Kit Codes” on page 28](#)
- ➔ [“Replacing the Roller Assembly Kit” on page 88](#)

Resetting the Number of Scans After Regular Cleaning

Reset the number of scans using Epson Scan 2 Utility after regular cleaning.

1. Turn on the scanner.
2. Start Epson Scan 2 Utility.
 - ❑ Windows 10
Click the start button, and then select **EPSON > Epson Scan 2 Utility**.

- ❑ Windows 8.1/Windows 8

Start screen > Apps > Epson > Epson Scan 2 Utility.

- ❑ Windows 7/Windows Vista/Windows XP

Click the start button, and then select **All Programs (or Programs) > EPSON > Epson Scan 2 > Epson Scan 2 Utility.**

- ❑ Mac OS

Select **Go > Applications > Epson Software > Epson Scan 2 Utility.**

3. Click the **Maintenance** tab.
4. Click **Reset** on **Regular Cleaning**.

Note:

You cannot reset when **Regular Cleaning Alert** is not selected.

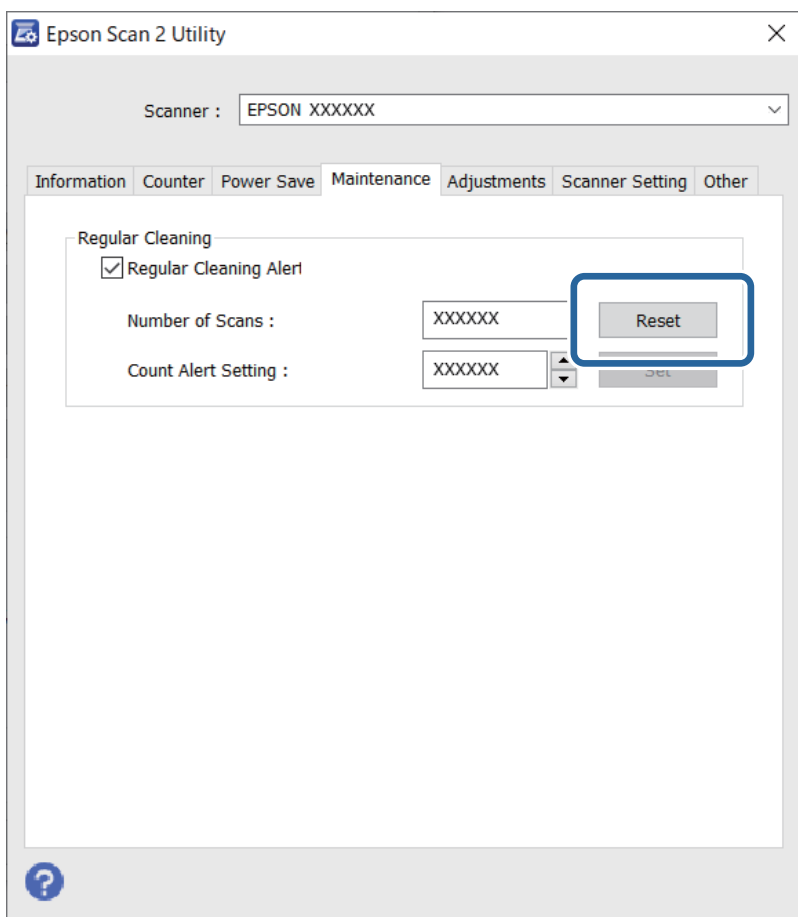

Replacing the Roller Assembly Kit

The roller assembly kit (the pickup roller and the separation roller) needs to be replaced when the number of scans exceeds the life cycle of the rollers. When a replacement message is displayed on your computer screen, follow the steps below to replace it.

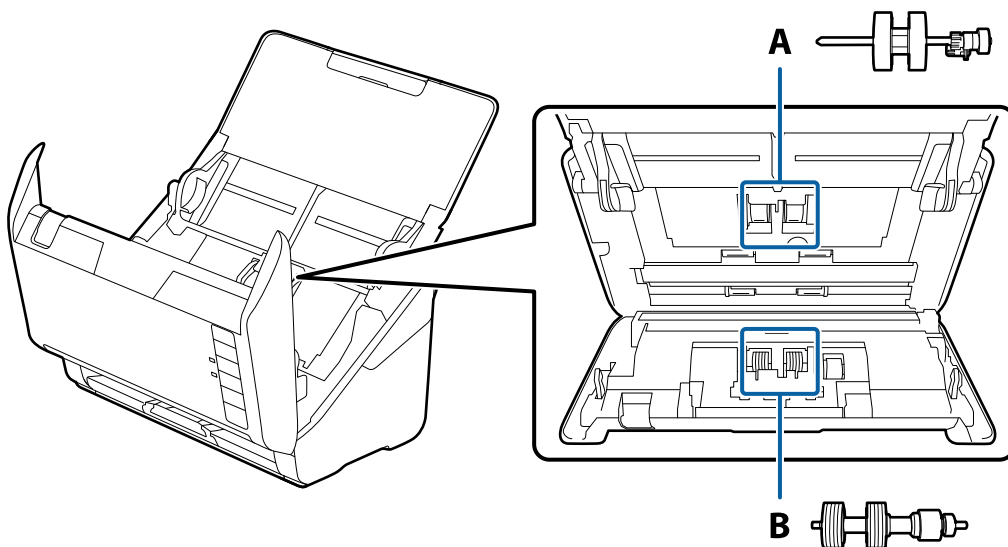

A: pickup roller, B: separation roller

1. Press the  button to turn off the scanner.
2. Unplug the AC adapter from the scanner.
3. Pull the lever and open the scanner cover.

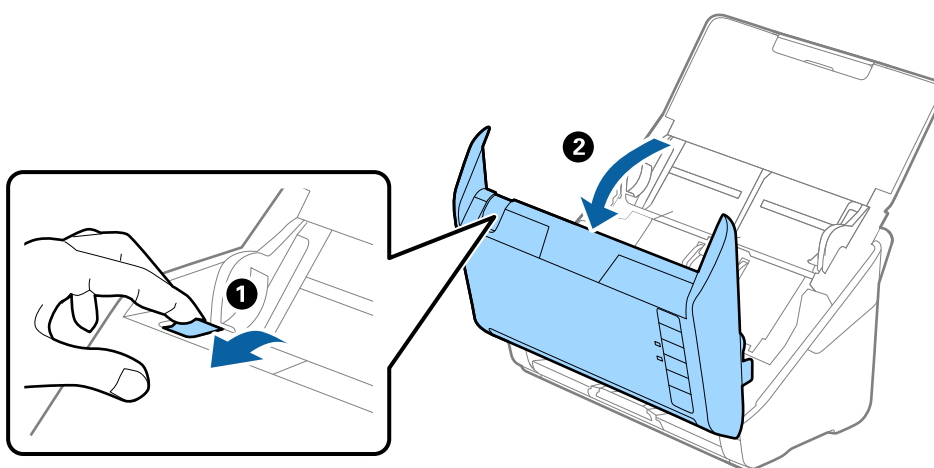

4. Open the cover of the pickup roller, and then slide and remove it.

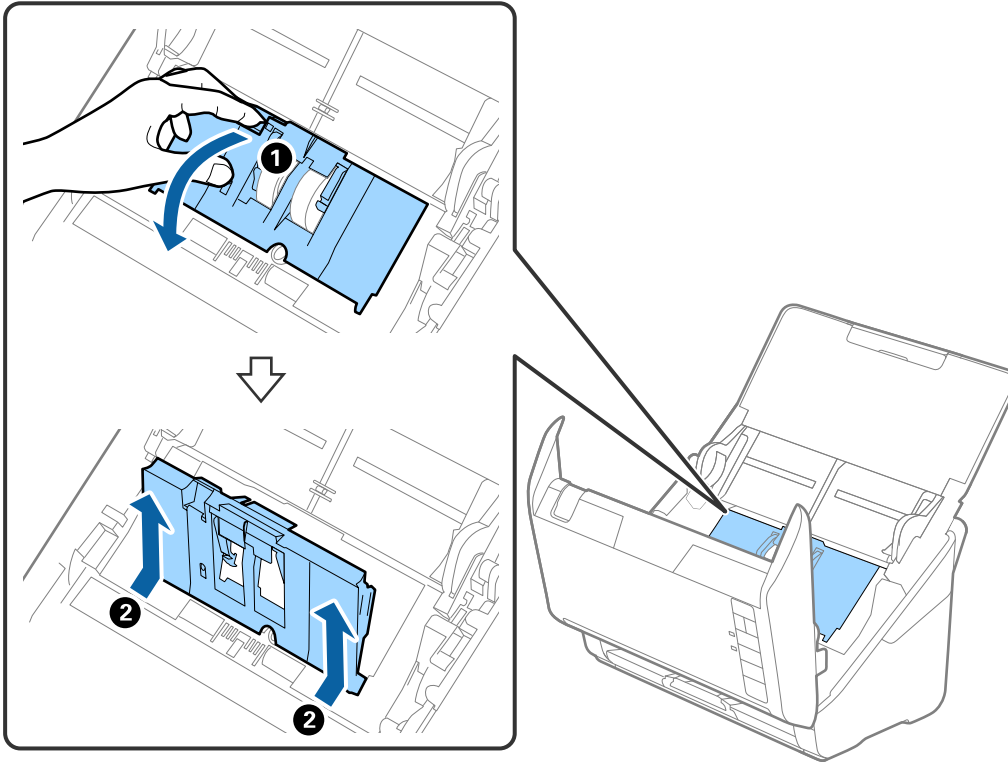

5. Pull down the fixture of the roller axis, and then slide and remove the installed pickup rollers.

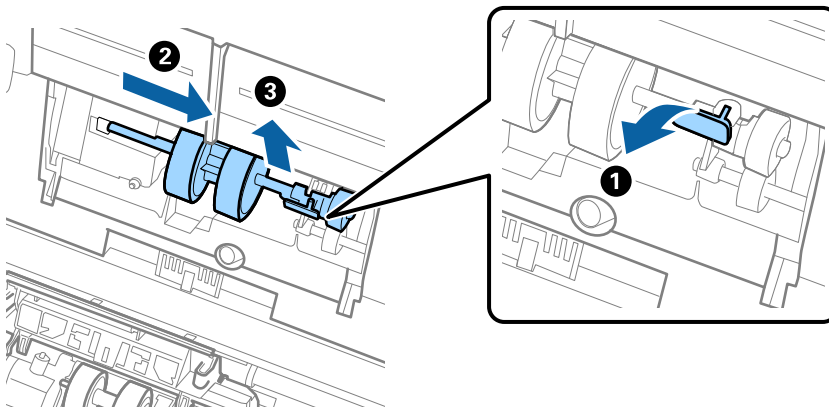

Important:

Do not pull out the pickup roller forcibly. This could damage the inside of the scanner.

6. While holding down the fixture, slide the new pickup roller to the left and insert it into the hole in the scanner. Press the fixture to secure it.

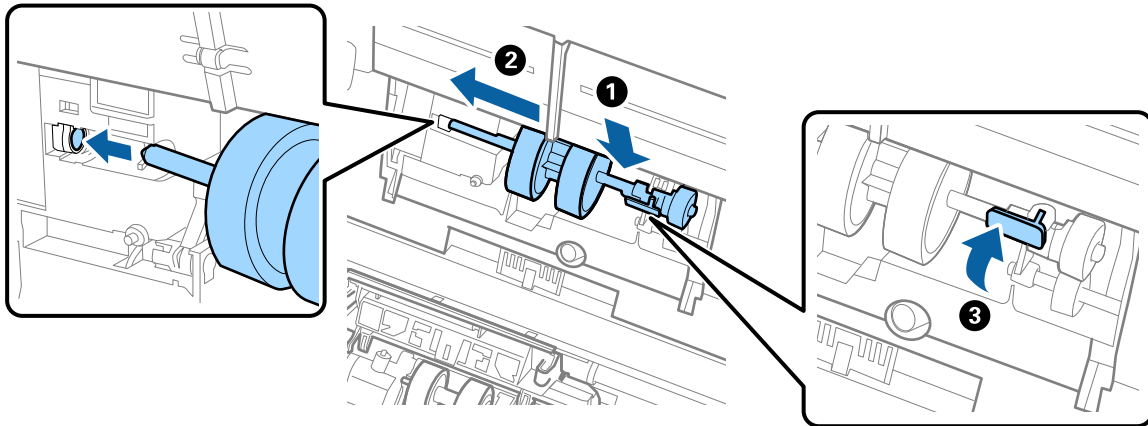

7. Put the edge of the cover of the pickup roller into the groove and slide it. Close the cover firmly.

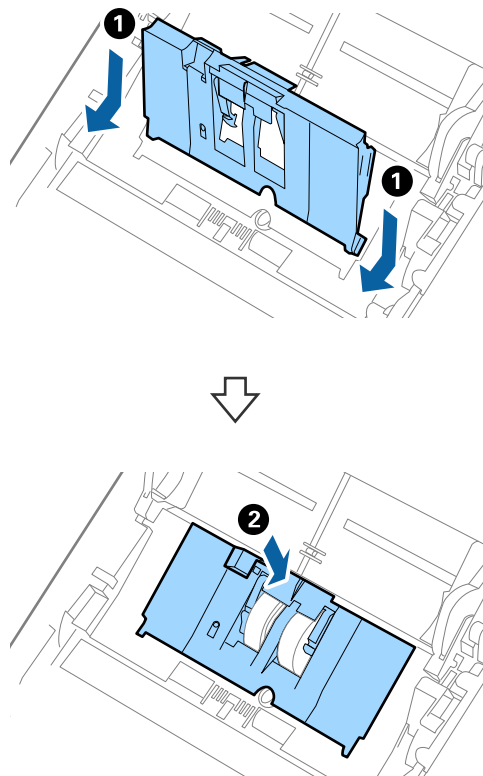

! *Important:*

- Make sure the pick up cover is closed correctly.*
- Make sure the pickup rollers are installed correctly if the cover is hard to close.*
- Do not install the cover while it is raised.*

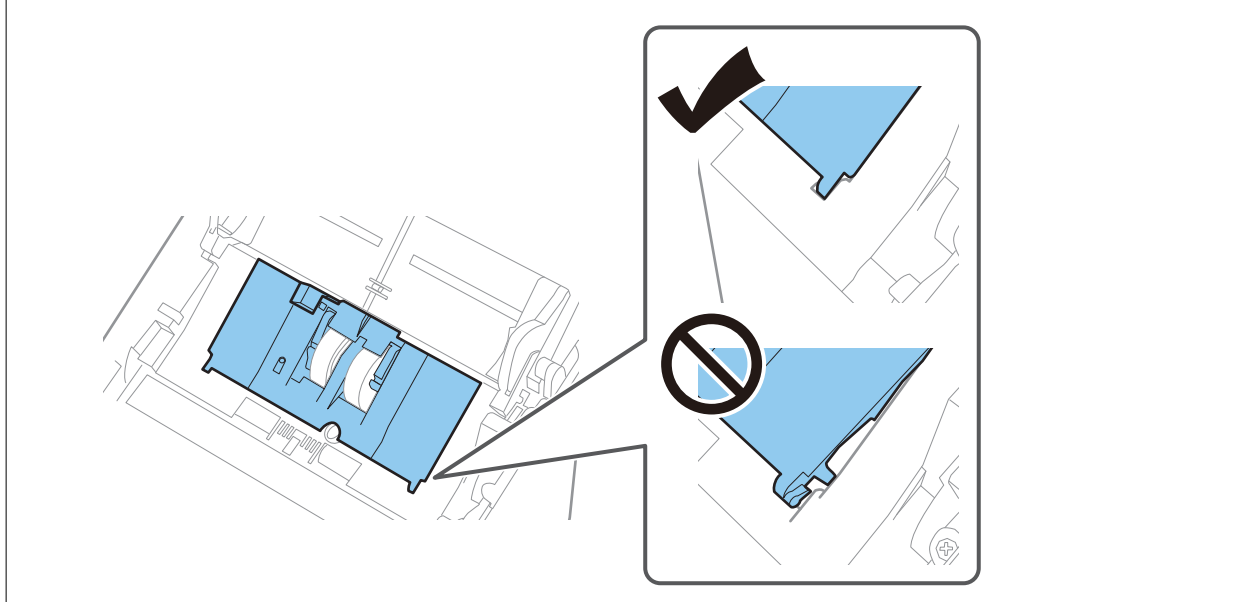

8. Push the hooks on both ends of the separation roller cover to open the cover.

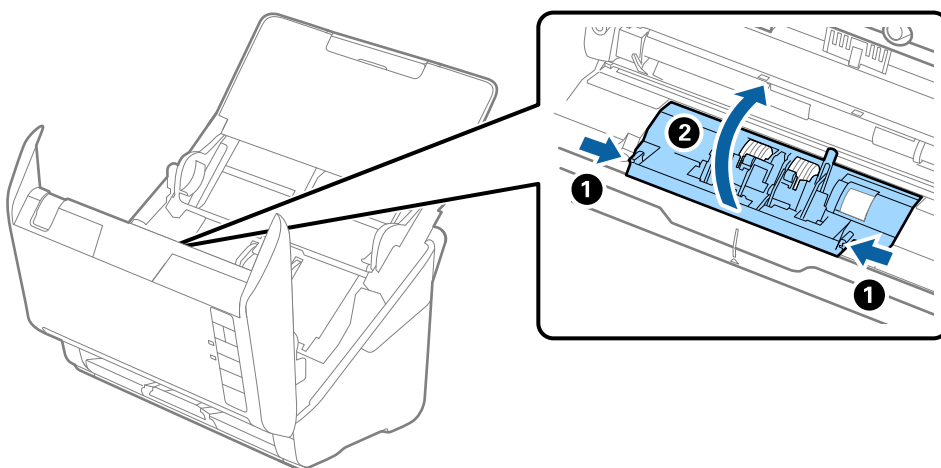

9. Lift the left side of the separation roller, and then slide and remove the installed separation rollers.

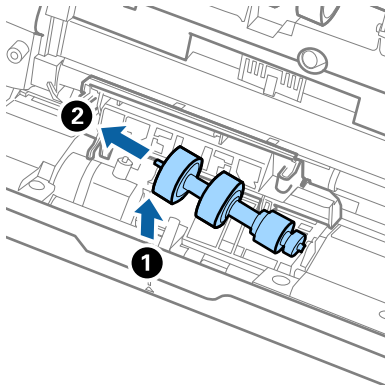

10. Insert the new separation roller axis into the hole on the right side, and then lower the roller.

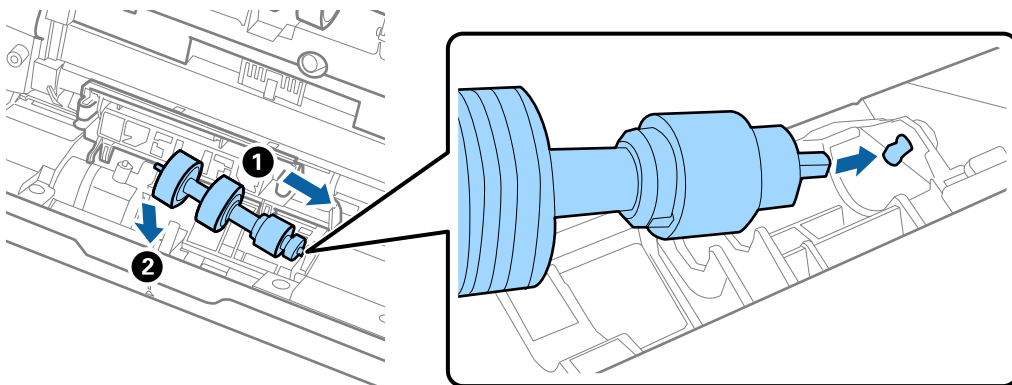

11. Close the separation roller cover.



Important:

If the cover is hard to close, make sure the separation rollers are installed correctly.

12. Close the scanner cover.
13. Plug in the AC adapter, and then turn on the scanner.
14. Reset the scan number by using Epson Scan 2 Utility.

Note:

Dispose of the pickup roller and the separation roller following the rules and regulations of your local authority. Do not disassemble them.

Related Information

➔ [“Roller Assembly Kit Codes” on page 27](#)

Resetting the Number of Scans After Replacing the Rollers

Reset the number of scans using Epson Scan 2 Utility after replacing the Roller Assembly Kit.

1. Turn on the scanner.
2. Start Epson Scan 2 Utility.
 - Windows 10
Click the start button, and then select **EPSON > Epson Scan 2 Utility**.
 - Windows 8.1/Windows 8
Start screen > Apps > Epson > Epson Scan 2 Utility.
 - Windows 7/Windows Vista/Windows XP
Click the start button, and then select **All Programs (or Programs) > EPSON > Epson Scan 2 > Epson Scan 2 Utility**.
 - Mac OS
Select **Go > Applications > Epson Software > Epson Scan 2 Utility**.
3. Click the **Counter** tab.
4. Click **Reset** on **Roller Assembly Kit**.

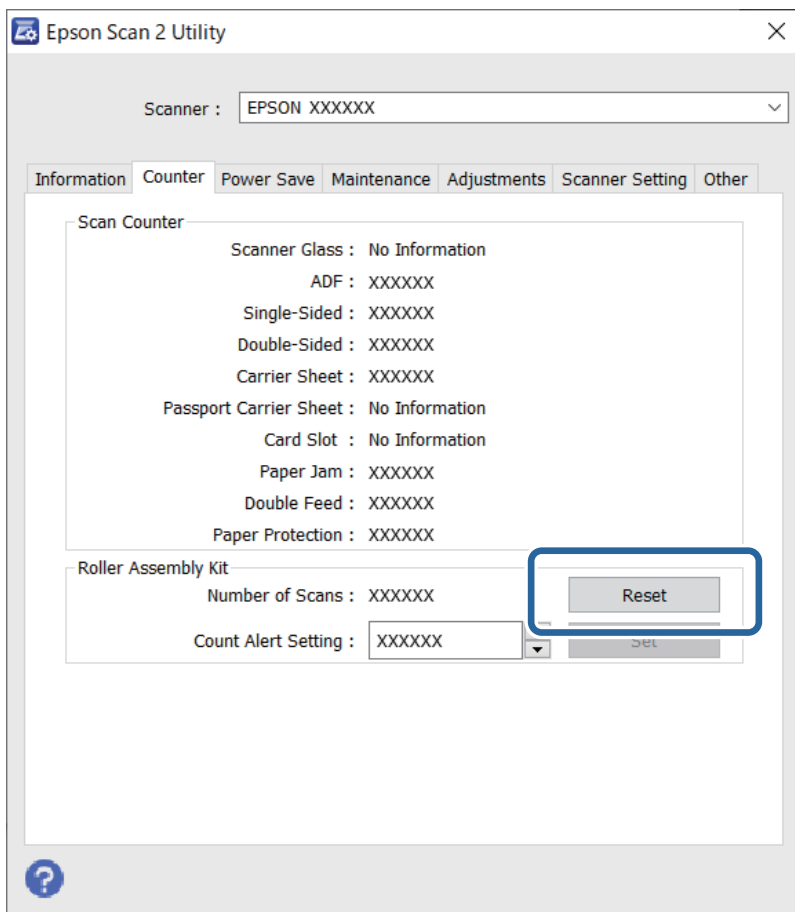

Related Information

➔ [“Replacing the Roller Assembly Kit” on page 88](#)

Energy Saving

You can save energy by using the sleep mode or auto power off mode when no operations are performed by the scanner. You can set the time period before the scanner enters sleep mode and turns off automatically. Any increase will affect the product's energy efficiency. Consider the environment before making any changes.

1. Start Epson Scan 2 Utility.
 - Windows 10
Click the start button, and then select **EPSON > Epson Scan 2 Utility**.
 - Windows 8.1/Windows 8
Start screen > Apps > Epson > Epson Scan 2 Utility.
 - Windows 7/Windows Vista/Windows XP
Click the start button, and then select **All Programs (or Programs) > EPSON > Epson Scan 2 > Epson Scan 2 Utility**.
 - Mac OS
Select **Go > Applications > Epson Software > Epson Scan 2 Utility**.
2. Click the **Power Save** tab.
3. Set the **Sleep Timer (minutes)** or **Power Off Timer (minutes)**, and then click **Set**.

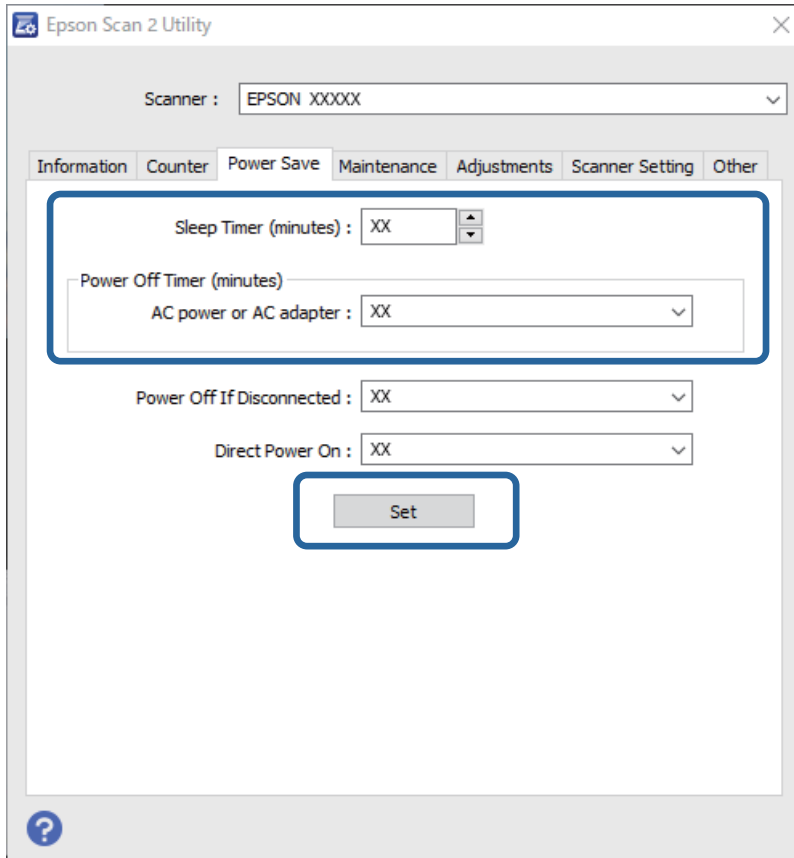

Transporting the Scanner

When you need to transport the scanner to move or for repairs, follow the steps below to pack the scanner.

1. Press the  button to turn off the scanner.
2. Unplug the AC adapter from the scanner.
3. Remove the USB cable.
4. Close the input tray and output tray.

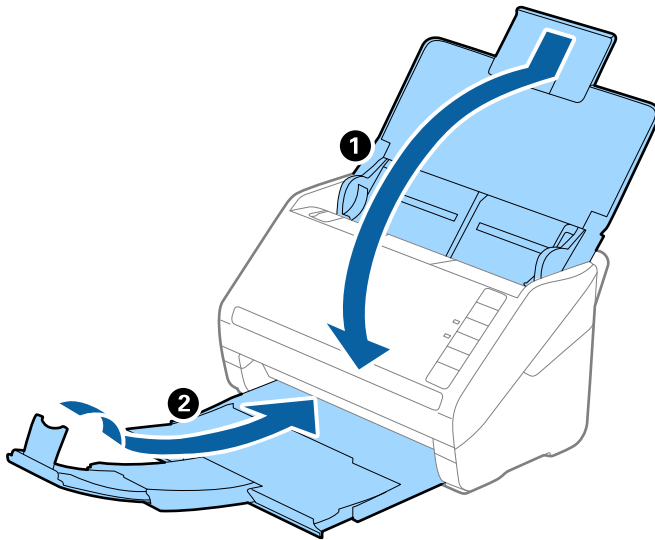

Important:

Make sure you close the output tray securely; otherwise it may be damaged during transport.

5. Attach the packing materials that came with the scanner, and then repack the scanner in its original box or a sturdy box.

Updating Applications and Firmware

You may be able to clear certain problems and improve or add functions by updating the applications and the firmware. Make sure you use the latest version of the applications and firmware.



Important:

Do not turn off the computer or the scanner while updating.

1. Make sure that the scanner and the computer are connected, and the computer is connected to the internet.

2. Start EPSON Software Updater and update the applications or the firmware.

- Windows 10

Click the start button, and then select **Epson Software > EPSON Software Updater**.

- Windows 8.1/Windows 8

Enter the application name in the search charm, and then select the displayed icon.

- Windows 7

Click the start button, and then select **All Programs** or **Programs > Epson Software > EPSON Software Updater**.

- Mac OS

Select **Finder > Go > Applications > Epson Software > EPSON Software Updater**.

Note:

If you cannot find the application you want to update in the list, you cannot update using the EPSON Software Updater. Check for the latest versions of the applications on your local Epson website.

<http://www.epson.com>

Updating Firmware Using Web Config

When the scanner can connect to the Internet, you can update the firmware from Web Config.

1. Access Web Config and select the **Device Management** tab > **Firmware Update**.
2. Click **Start**, and then follow the on-screen instructions.

The firmware confirmation starts, and the firmware information is displayed if the updated firmware exists.

Note:

You can also update the firmware using Epson Device Admin. You can visually confirm the firmware information on the device list. It is useful when you want to update multiple devices' firmware. See the Epson Device Admin guide or help for more details.

Updating Firmware without Connecting to the Internet

You can download the device's firmware from Epson website on the computer, and then connect the device and the computer by USB cable to update the firmware. If you cannot update over the network, try this method.

Note:

Before updating, make sure that the application Epson ScanSmart is installed on your computer. If Epson ScanSmart is not installed, install it again.

1. Check the Epson website for the latest firmware update releases.

<http://www.epson.com>

- If there is the firmware for your scanner, download it and go to the next step.
- If there is no firmware information on the website, you are already using the latest firmware.

2. Connect the computer that contains the downloaded firmware to the scanner by USB cable.

3. Double-click the downloaded .exe file.
Epson Firmware Updater starts.
4. Follow the on-screen instructions.

Solving Problems

Scanner Problems.	99
Problems Starting Scanning.	99
Paper Feeding Problems.	106
Scanned Image Problems.	110
Uninstalling and Installing Applications.	115

Scanner Problems

Scanner Lights Indicate an Error

Check the following if the scanner lights indicate an error.

- Make sure there are no originals jammed in the scanner.
- When feeding multiple originals, open the ADF cover and remove the originals. Next, close the ADF cover.
- Make sure the scanner cover is closed.
- Make sure the scanner is connected to your computer properly.
 - If a Wi-Fi connection error has occurred, check the Wi-Fi connection settings.
- Make sure Epson Scan 2 is installed correctly.
- If the firmware update fails and the scanner enters recovery mode, update the firmware again using a USB connection.
- Turn off the scanner and turn it on again. If this does not solve the problem, the scanner may be malfunctioning, or the light source in the scanner unit may need to be replaced. Contact your dealer.

Related Information

- ➔ [“Error Indicators” on page 22](#)
- ➔ [“The Original Jams in the Scanner Frequently” on page 108](#)

The Scanner Does Not Turn On

- Make sure the AC adapter is securely connected to the scanner and an electrical outlet.
- Check that the electrical outlet is working. Plug another device into the electrical outlet and check that you can turn the power on.

Problems Starting Scanning

Cannot Start Scanning from Computer

Make sure the smart device and the scanner are connected correctly.

The cause and solution to the problem differ depending on whether or not they are connected.

Checking the Connection Status (Windows)

Use Epson Scan 2 Utility to check the connection status.

Note:

Epson Scan 2 Utility is an application supplied with the scanner software.

1. Start the Epson Scan 2 Utility.
 - ❑ Windows 10
Click the start button, and then select **EPSON > Epson Scan 2 Utility**.
 - ❑ Windows 8.1/Windows 8
Enter the application name in the search charm, and then select the displayed icon.
 - ❑ Windows 7
Click the start button, and then select **All Programs** or **Programs > EPSON > Epson Scan 2 Utility**.
2. On the **Epson Scan 2 Utility** screen, open the **Scanner** list, and then click **Settings** to open the **Scanner Settings** screen.
If the **Scanner Settings** screen is already displayed instead of the **Epson Scan 2 Utility** screen, go to the next.
3. If the scanner is not displayed on the **Scanner Settings** screen, your scanner is not detected.
Click **Add**, and then add your scanner on the **Add Network Scanner** screen.

If you cannot search for the scanner or cannot scan even if the correct scanner is selected, see the related information.

Related Information



- ➔ [“Cannot connect to a Network” on page 101](#)
- ➔ [“The Scanner Cannot Connect by USB” on page 103](#)
- ➔ [“Cannot Scan Even Though a Connection has been Correctly Established” on page 103](#)

Checking the Connection Status (Mac OS)

Use Epson Scan 2 Utility to check the connection status.

Note:

Epson Scan 2 Utility is an application supplied with the scanner software.

1. Start the Epson Scan 2 Utility.
Select **Go > Applications > Epson Software > Epson Scan 2 Utility**.
2. On the **Epson Scan 2 Utility** screen, open the **Scanner** list, and then click **Settings** to open the **Scanner Settings** screen.
If the **Scanner Settings** screen is already displayed instead of the **Epson Scan 2 Utility** screen, go to the next
3. If the scanner is not displayed on the **Scanner Settings** screen, your scanner is not detected.
Click the  icon, and then allow the software to make changes.
4. Click the  icon, and then add your scanner on the **Add Network Scanner** screen.

If you cannot search for the scanner or cannot scan even if the correct scanner is selected, see the related information.

Related Information

- ➔ [“Cannot connect to a Network” on page 101](#)
- ➔ [“The Scanner Cannot Connect by USB” on page 103](#)
- ➔ [“Cannot Scan Even Though a Connection has been Correctly Established” on page 103](#)

Cannot connect to a Network

The problem could be one of the following issues.

■ Something is wrong with the network devices for Wi-Fi connection.

Solutions

Turn off the devices you want to connect to the network. Wait for about 10 seconds, and then turn on the devices in the following order; wireless router, computer or smart device, and then scanner. Move the scanner and computer or smart device closer to the wireless router to help with radio wave communication, and then try to make network settings again.

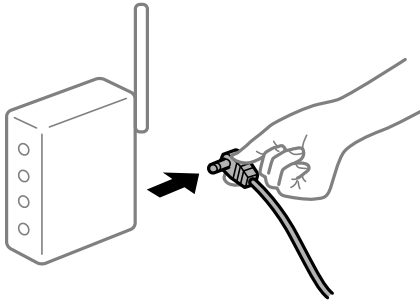

■ Devices cannot receive signals from the wireless router because they are too far apart.

Solutions

After moving the computer or the smart device and the scanner closer to the wireless router, turn off the wireless router, and then turn it back on.

■ When changing the wireless router, the settings do not match the new router.

Solutions

Make the connection settings again so that they match the new wireless router.

■ The SSIDs connected from the computer or smart device and computer are different.

Solutions

When you are using multiple wireless routers at the same time or the wireless router has multiple SSIDs and devices are connected to different SSIDs, you cannot connect to the wireless router.

Connect the computer or smart device to the same SSID as the scanner.

- ❑ Example of connecting to different SSIDs

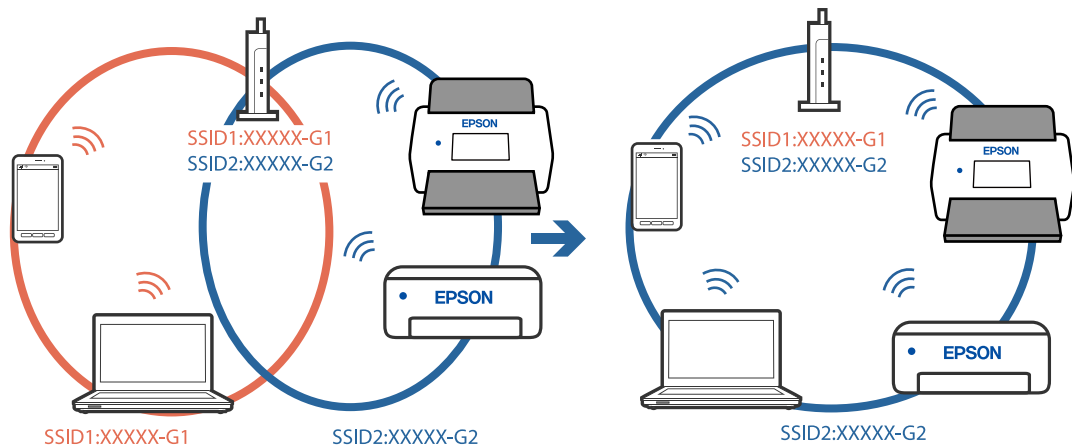

- ❑ Example of connecting to SSIDs with a different frequency range

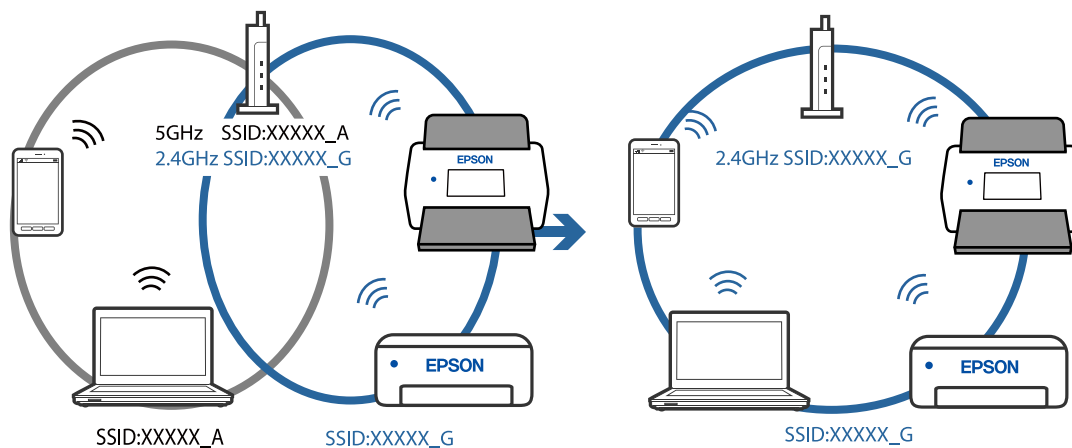

A privacy separator on the wireless router is available.

Solutions

Most wireless routers have a privacy separator feature that blocks communication between connected devices. If you cannot communicate between the scanner and the computer or smart device even if they are connected to the same network, disable the privacy separator on the wireless router. See the manual provided with the wireless router for details.

The IP address is incorrectly assigned.

Solutions

If the IP address assigned to the scanner is 169.254.XXX.XXX, and the subnet mask is 255.255.0.0, the IP address may not be assigned correctly.

Click **Add** on the **Scanner Settings** screen in Epson Scan 2 Utility. Select the model you are using, enter the IP address, and then click **OK**.

Restart the wireless router or reset the network settings for the scanner.

■ **There is a problem with the network settings on the computer.**

Solutions

Try accessing any website from your computer to make sure that your computer's network settings are correct. If you cannot access any website, there is a problem on the computer.

Check the network connection of the computer. See the documentation provided with the computer for details.

■ **The scanner is off.**

Solutions

Make sure the scanner is turned on.

Also, wait until the status light stops flashing indicating that the scanner is ready to scan.

The Scanner Cannot Connect by USB

The following causes can be considered.

■ **The USB cable is not plugged into the electrical outlet correctly.**

Solutions

Connect the USB cable securely to the scanner and the computer.

■ **There is a problem with the USB hub.**

Solutions

If you are using a USB hub, try to connect the scanner directly to the computer.

■ **There is a problem with the USB cable or the USB inlet.**

Solutions

If the USB cable cannot be recognized, change the port, or change the USB cable.

■ **The scanner is off.**

Solutions

Make sure the scanner is turned on.

Also, wait until the status light stops flashing indicating that the scanner is ready to scan.

Cannot Scan Even Though a Connection has been Correctly Established

■ **Required applications are not installed on your computer.**

Solutions

Make sure the application Epson ScanSmart is installed.

If Epson ScanSmart is not installed, install it again.

➔ [“Installing Your Applications” on page 116](#)

If you are using any TWAIN-compliant programs, the correct scanner is not selected as the source setting. (Windows)

Solutions

Make sure that you select the correct scanner from your programs list.

Cannot Start Scanning from Smart Device

Make sure the smart device and the scanner are connected correctly.

The cause and solution to the problem differ depending on whether or not they are connected.

Checking the Connection Status (Smart Device)

You can use Epson Smart Panel to check the connection status for the smart device and the scanner.

1. Start Epson Smart Panel on your smart device.
2. Check whether or not the scanner name is displayed in Epson Smart Panel.

If the scanner name is displayed, a connection has been successfully established between the smart device and the scanner.

If a message is displayed saying that the scanner is not selected, a connection has not been established between the smart device and the scanner. Follow the instructions on the Epson Smart Panel to connect to the scanner.

If you cannot connect to the scanner over a network, check the Related Information.

Related Information

➔ [“Cannot connect to a Network” on page 104](#)

Cannot connect to a Network

The problem could be one of the following issues.

Something is wrong with the network devices for Wi-Fi connection.

Solutions

Turn off the devices you want to connect to the network. Wait for about 10 seconds, and then turn on the devices in the following order; wireless router, computer or smart device, and then scanner. Move the scanner and computer or smart device closer to the wireless router to help with radio wave communication, and then try to make network settings again.

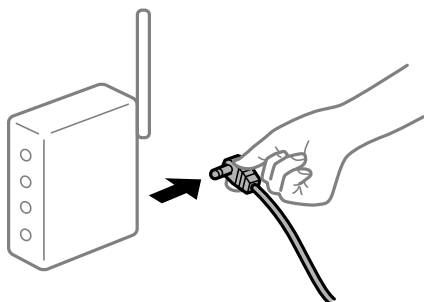

Devices cannot receive signals from the wireless router because they are too far apart.

Solutions

After moving the computer or the smart device and the scanner closer to the wireless router, turn off the wireless router, and then turn it back on.

When changing the wireless router, the settings do not match the new router.

Solutions

Make the connection settings again so that they match the new wireless router.

The SSIDs connected from the computer or smart device and computer are different.

Solutions

When you are using multiple wireless routers at the same time or the wireless router has multiple SSIDs and devices are connected to different SSIDs, you cannot connect to the wireless router.

Connect the computer or smart device to the same SSID as the scanner.

Example of connecting to different SSIDs

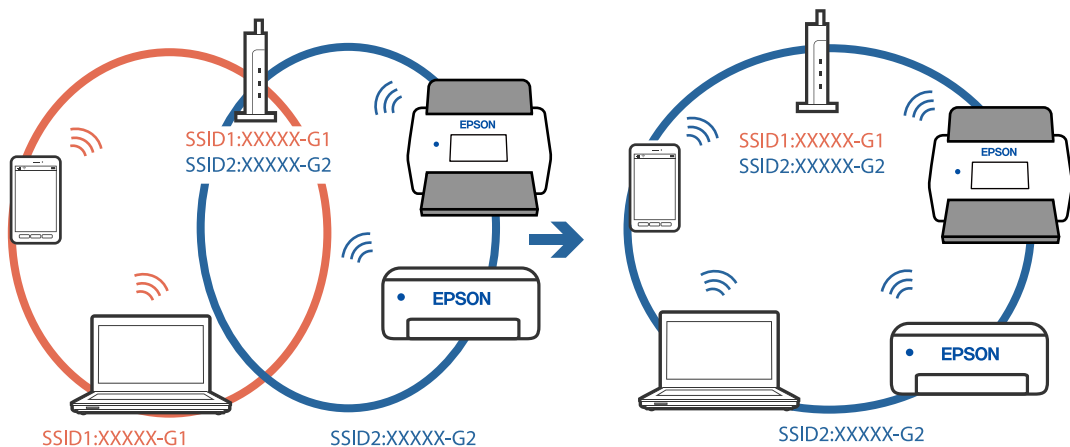

Example of connecting to SSIDs with a different frequency range

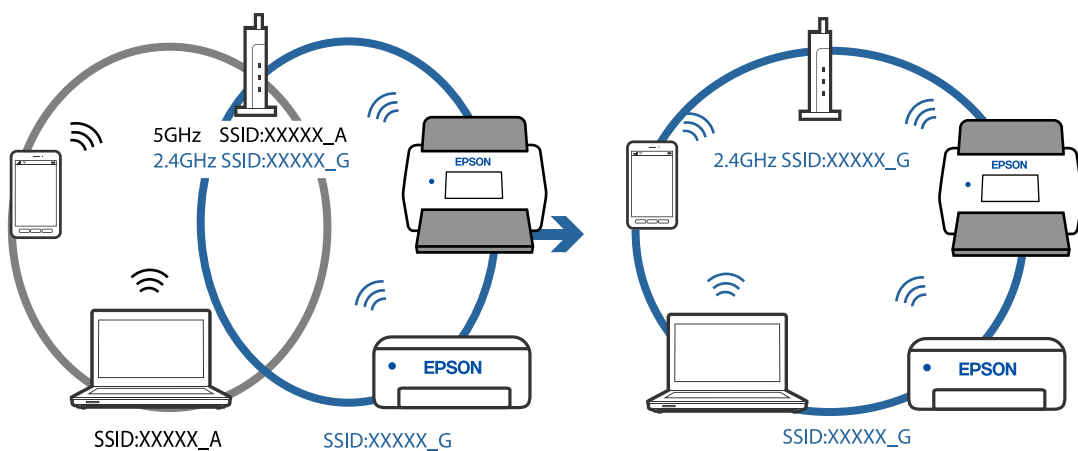

■ A privacy separator on the wireless router is available.

Solutions

Most wireless routers have a privacy separator feature that blocks communication between connected devices. If you cannot communicate between the scanner and the computer or smart device even if they are connected to the same network, disable the privacy separator on the wireless router. See the manual provided with the wireless router for details.

■ The IP address is incorrectly assigned.

Solutions

If the IP address assigned to the scanner is 169.254.XXX.XXX, and the subnet mask is 255.255.0.0, the IP address may not be assigned correctly.

Click **Add** on the **Scanner Settings** screen in Epson Scan 2 Utility. Select the model you are using, enter the IP address, and then click **OK**.

Restart the wireless router or reset the network settings for the scanner.

■ There is a problem with the network settings on the smart device.

Solutions

Try accessing any website from your smart device to make sure that your smart device's network settings are correct. If you cannot access any website, there is a problem on the smart device.

Check the network connection of the computer. See the documentation provided with the smart device for details.

■ The scanner is off.

Solutions

Make sure the scanner is turned on.

Also, wait until the status light stops flashing indicating that the scanner is ready to scan.

Paper Feeding Problems

Multiple Originals Are Fed (Double Feed)

Check the following when a double feed occurs.

- When originals are jammed inside the scanner, open the scanner cover and remove the originals, and then close the scanner cover.
- Check the scanned image, and then scan the originals again if necessary.

If multiple originals are fed frequently, try the following.

- If you load unsupported originals, the scanner may feed multiple originals at a time.
- Clean the rollers inside the scanner.
- Reduce the number of originals being placed at a time.
- Press the  button to slow down the scanning speed.

- ❑ Use **Automatic Feeding Mode**, and scan originals one by one.

Related Information

➔ [“Removing Jammed Originals from the Scanner” on page 107](#)

➔ [“Scanning Different Sizes or Types of Originals One by One Continuously \(Automatic Feeding Mode\)” on page 73](#)

You can scan different sizes or types of originals one by one using Automatic Feeding Mode. In this mode, the scanner starts scanning automatically when originals are loaded into the scanner.

➔ [“Cleaning Inside the Scanner” on page 82](#)

Removing Jammed Originals from the Scanner

If an original has jammed inside the scanner, follow these steps to remove it.

Note:

Epson Smart Panel does not support scanning for long paper (393.8 mm (15.5 in.) or more).

1. Remove all originals remaining in the input tray.
2. Pull the lever and open the scanner cover.

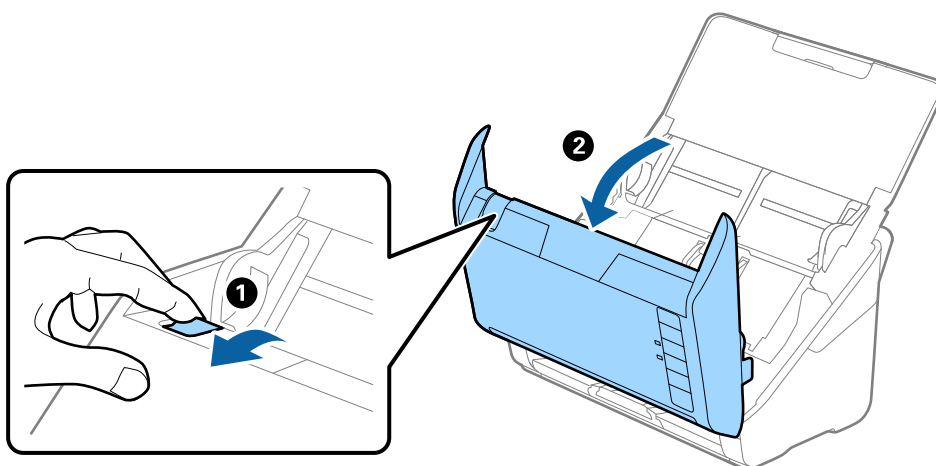

- Carefully remove any originals remaining inside the scanner.

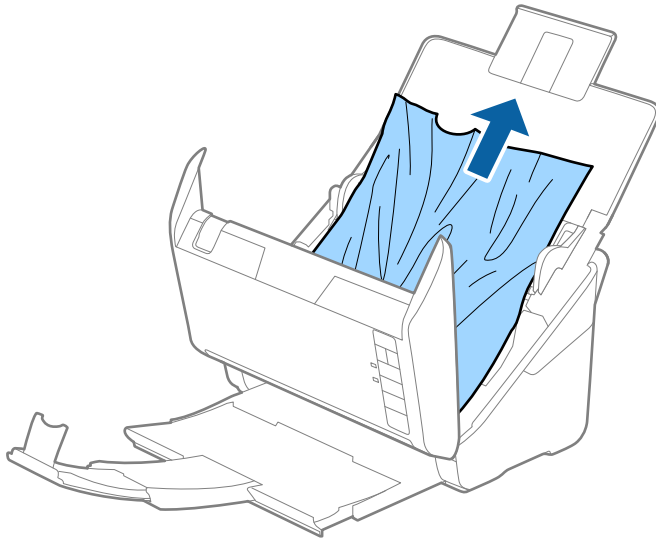

- If you cannot pull originals straight up, carefully pull out any jammed originals from the output tray in the direction of the arrow.

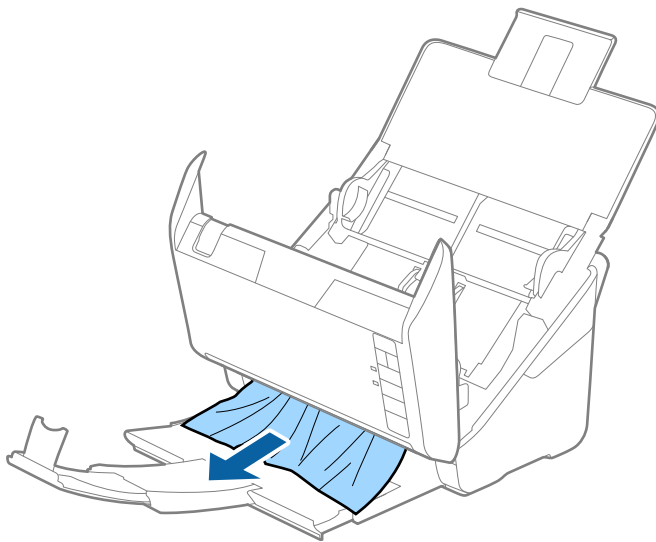

Important:

Make sure there is no paper inside the scanner.

- Close the scanner cover.

The Original Jams in the Scanner Frequently

If the original jams in the scanner frequently, try the following.

- Press the  button to slow down the scanning speed.
- Clean the rollers inside the scanner.

- If the ejected originals get stuck in the output tray, store the output tray and do not use it.

Related Information

- ➔ [“Cleaning Inside the Scanner” on page 82](#)

Paper Protection Does not Work Correctly

Depending on the original and the level you set, this feature may not work correctly.

- Select **Off** to disable the feature when scanning plastic cards or thick paper.
- When misdetection occurs frequently, lower the level of this feature.
- If your original is damaged, check that this feature is enabled. If it is already enabled, increase the level of protection for the feature.

Related Information

- ➔ [“Setting the Document Protection Feature” on page 78](#)

The Originals Get Dirty

Clean the inside of the scanner.

Related Information

- ➔ [“Cleaning Inside the Scanner” on page 82](#)

Scanning Speed Slows Down when Scanning Continuously

When scanning continuously using the ADF, scanning slows down to prevent the scanner mechanism from overheating and being damaged. However, you can continue scanning.

To regain normal scanning speed, leave the scanner idle for at least 30 minutes. Scanning speed does not recover even if the power is off.

Scanning Takes a Long Time

- The scanning speed may slow down depending on the scanning conditions, such as high resolution, image adjustment features, file format, and so on.
- Computers with USB 3.0 (SuperSpeed) or USB 2.0 (Hi-Speed) ports can scan faster than those with USB 1.1 ports. If you are using a USB 3.0 or USB 2.0 port with the scanner, make sure it meets the system requirements.
- When using security software, exclude the TWAIN.log file from monitoring, or set the TWAIN.log as a read-only file. For more information on your security software's functions, see the help and so on supplied with the software. The TWAIN.log file is saved in the following locations.
C:\Users*(user name)*\AppData\Local\Temp

Scanned Image Problems

Straight Lines Appear when Scanning from ADF

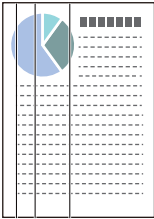

- Clean the ADF.

Straight lines may appear in the image when trash or dirt gets into the ADF.

- Remove any trash or dirt that adheres to the original.
- Using **Detect Glass Dirt** feature, alert message appears when dirt is detected on the scanner glass.

Select **Scanner Setting** tab and then select **On-High** or **On-Low** from **Detect Glass Dirt** in Epson Scan 2 Utility .

When an alert is displayed, clean the glass surfaces inside your scanner using a genuine Epson cleaning kit or a soft cloth.

Note:

- Depending on the dirt, it may not be detected correctly.
- If the detection does not work correctly, change the setting.
Select **On-High** if the dirt is not detected. Select **On-Low** or **Off** if the alert is displayed by a misdetection.

Related Information

➔ [“Cleaning Inside the Scanner” on page 82](#)

Glass Dirt Alert Does Not Disappear

If the glass dirt alert screen appears after cleaning the inside of the scanner, check the glass surface again. If there are scratches on the glass, they will be detected as a glass dirt.

Glass part will be required to replace. Contact your local dealer to repair.

Colors Are Uneven in the Scanned Image

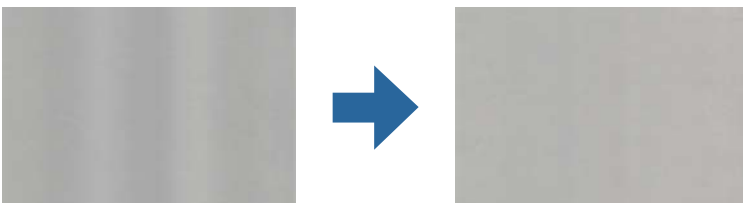

If the scanner is subject to strong light such as direct sunlight, the sensor inside the scanner misdetects the light and colors in the scanned image become uneven.

- Change the orientation of the scanner so that no strong light is falling on the front of the scanner.
- Move the scanner to a location where it will not be subjected to strong light.

Expanding or Contracting the Scanned Image

When expanding or contracting the scanned image, you can adjust the expansion ratio by using the **Adjustments** feature in Epson Scan 2 Utility. This feature is only available for Windows.



Note:

Epson Scan 2 Utility is one of the applications supplied with the scanner software.

1. Start Epson Scan 2 Utility.
 - Windows 10
Click the start button, and then select **EPSON > Epson Scan 2 Utility**.
 - Windows 8.1/Windows 8
Enter the application name in the search charm, and then select the displayed icon.
 - Windows 7
Click the start button, and then select **All Programs** or **Programs > EPSON > Epson Scan 2 > Epson Scan 2 Utility**.
2. Select the **Adjustments** tab.
3. Use **Expansion/Contraction** to adjust the expansion ratio for scanned images.
4. Click **Set** to apply the settings to the scanner.

Offset Appears in the Background of Images

Images on the back of the original may appear in the scanned image.

- When **Auto**, **Color**, or **Grayscale** is selected as the **Image Type**.
 - Check that **Remove Background** is selected.
Click  **Settings** in **Epson ScanSmart, Review Scans** or on the **Select Action** window, and then click the **Scanner Settings** tab > **Scan Settings** button > **Advanced Settings** tab on the Epson Scan 2 window > **Remove Background**.
 - Check that **Text Enhancement** is selected.
Click  **Settings** in **Epson ScanSmart, Review Scans** or on the **Select Action** window > **Scanner Settings** tab > **Scan Settings** button > **Advanced Settings** tab in Epson Scan 2 window > **Text Enhancement**.

- When **Black & White** is selected as the **Image Type**.

- Check that **Text Enhancement** is selected.

Click  **Settings** in **Epson ScanSmart, Review Scans** or on the **Select Action** window, and then click the **Scanner Settings** tab > **Scan Settings** button > **Advanced Settings** tab on the Epson Scan 2 window > **Text Enhancement**.

Depending on the condition of your scanned image, click **Settings** and try setting a lower level for **Edge Enhancement** or a higher level for **Noise Reduction Level**.

Scanned Image or Text is Blurred

You can adjust the appearance of the scanned image or text by increasing the resolution or adjusting the image quality.

- Try increasing the resolution and then scanning.

Set the appropriate resolution for the purpose of your scanned image.

Click  **Settings** in **Epson ScanSmart, Review Scans** or on the **Select Action** window, and then click the **Scanner Settings** tab > **Scan Settings** button > **Main Settings** tab on the Epson Scan 2 window > **Resolution**.

- Check that **Text Enhancement** is selected.

Click  **Settings** in **Epson ScanSmart, Review Scans** or on the **Select Action** window, and then click the **Scanner Settings** tab > **Scan Settings** button > **Advanced Settings** tab on the Epson Scan 2 window > **Text Enhancement**.

- When **Black & White** is selected as the **Image Type**.

Depending on the condition of your scanned image, click **Settings** and try setting a lower level for **Edge Enhancement** or a higher level for **Noise Reduction Level**.

- If you are scanning in JPEG format, try to change the compression level.

Click  **Settings** in **Epson ScanSmart, Review Scans** or on the **Select Action** window, and then click the **Save Settings** tab > **Options** button

List of Recommended Resolutions to Suit Your Purpose

See the table and set the appropriate resolution for the purpose of your scanned image.

Purpose	Resolution (Reference)
Displaying on a screen Sending by email	Up to 200 dpi
Using Optical Character Recognition (OCR) Creating a text searchable PDF	200 to 300 dpi
Printing using a printer Sending by fax	200 to 300 dpi

Moiré Patterns (Web-Like Shadows) Appear

If the original is a printed document, moiré patterns (web-like shadows) may appear in the scanned image.

- Check that **Descreening** is selected.

Click  **Settings** in **Epson ScanSmart, Review Scans** or on the **Select Action** window, and then click the **Scanner Settings** tab > **Scan Settings** button > **Advanced Settings** tab on the Epson Scan 2 window > **Descreening**.



- Change the resolution, and then scan again.

Click  **Settings** in **Epson ScanSmart, Review Scans** or on the **Select Action** window, and then click the **Scanner Settings** tab > **Scan Settings** button > **Main Settings** tab on the Epson Scan 2 window > **Resolution**.

The Edge of the Original is Not Scanned when Automatically Detecting the Size of the Original

Depending on the original, the edge of the original may not be scanned when automatically detecting the size of the original.

- Click  **Settings** in **Epson ScanSmart, Review Scans** or on the **Select Action** window, and then click the **Scanner Settings** tab > **Scan Settings** button.

In Epson Scan 2, select the **Main Settings** tab, and then select **Document Size** > **Settings**. On the **Document Size Settings** window, adjust **Crop Margins for Size "Auto"**.

- Depending on the original, the area of the original may not be detected correctly when using the **Auto Detect** feature. Select the appropriate size of the original from the **Document Size** list.

Click  **Settings** in **Epson ScanSmart, Review Scans** or on the **Select Action** window, and then click the **Scanner Settings** tab > **Scan Settings** button.

In Epson Scan 2, click the **Main Settings** tab, and then click **Document Size**.

Note:

*If the size of the original you want to scan is not on the list, select **Customize**, and then create the size manually.*

Click  **Settings** in **Epson ScanSmart, Review Scans** or on the **Select Action** window, and then click the **Scanner Settings** tab > **Scan Settings** button.

*In Epson Scan 2, click the **Main Settings** tab, and then click **Customize** in **Document Size**.*

Character is not Recognized Correctly

Check the following to increase the recognition rate of OCR (Optical Character Recognition).

- Check that the original is placed straight.

- Use an original with clear text. Text recognition may decline for the following types of originals.
 - Originals that have been copied several times
 - Originals received by fax (at low resolutions)
 - Originals where the letter spacing or line spacing is too small
 - Originals with ruled lines or underlining over the text
 - Originals with hand written text
 - Originals with creases or wrinkles
- Paper type made of thermal paper such as receipts may deteriorate due to age or friction. Scan them as soon as possible.
- When saving to Microsoft® Office or **Searchable PDF** files, check that the correct languages are selected. Check the **Language** in each save setting window.

Cannot Solve Problems in the Scanned Image

If you have tried all of the solutions and have not solved the problem, initialize the application settings by using Epson Scan 2 Utility.

Note:

Epson Scan 2 Utility is one of the applications supplied with the scanner software.

1. Start Epson Scan 2 Utility.
 - Windows 10
Click the start button, and then select **EPSON > Epson Scan 2 Utility**.
 - Windows 8.1/Windows 8
Enter the application name in the search charm, and then select the displayed icon.
 - Windows 7
Click the start button, and then select **All Programs** or **Programs > EPSON > Epson Scan 2 > Epson Scan 2 Utility**.
 - Mac OS
Select **Go > Applications > Epson Software > Epson Scan 2 Utility**.
2. Select the **Other** tab.
3. Click **Reset**.

Note:

If initialization does not solve the problem, uninstall and re-install the scanner driver (Epson Scan 2).

Uninstalling and Installing Applications

Uninstalling Your Applications

You may need to uninstall and then reinstall your applications to solve certain problems or if you upgrade your operating system. Log on to your computer as an administrator. Enter the administrator password if the computer prompts you.

Uninstalling Your Applications for Windows

1. Quit all running applications.
2. Disconnect the scanner from your computer.
3. Open the Control Panel:
 - Windows 10
Right-click the start button or press and hold it, and then select **Control Panel**.
 - Windows 8.1/Windows 8
Select **Desktop > Settings > Control Panel**.
 - Windows 7
Click the start button and select **Control Panel**.
4. Select **Uninstall a program** in **Programs**.
5. Select the application you want to uninstall.
6. Click **Uninstall/Change** or **Uninstall**.

Note:
If the User Account Control window is displayed, click Continue.
7. Follow the on-screen instructions.

Note:
*A message may be displayed prompting you to restart your computer. If it is displayed, make sure **I want to restart my computer now** is selected, and then click **Finish**.*

Uninstalling Your Applications for Mac OS

Note:
Make sure you installed EPSON Software Updater.

1. Download the Uninstaller using EPSON Software Updater.
Once you have downloaded the Uninstaller, you do not need to download it again each time you uninstall the application.
2. Disconnect the scanner from your computer.

3. To uninstall the scanner driver, select **System Preferences** from the Apple menu > **Printers & Scanners** (or **Print & Scan, Print & Fax**), and then remove the scanner from the enabled scanner list.
4. Quit all running applications.
5. Select **Go > Applications > Epson Software > Uninstaller**.
6. Select the application you want to uninstall, and then click Uninstall.



Important:

The Uninstaller removes all drivers for Epson scanners on the computer. If you use multiple Epson scanners and you only want to delete some of the drivers, delete all of them first, and then install the necessary scanner drivers again.

Note:

*If you cannot find the application you want to uninstall in the application list, you cannot uninstall using the Uninstaller. In this situation, select **Go > Applications > Epson Software**, select the application you want to uninstall, and then drag it to the trash icon.*

Installing Your Applications

Follow the steps below to install the necessary applications.

Note:

- Log on to your computer as an administrator. Enter the administrator password if the computer prompts you.
- When reinstalling applications, you need to uninstall them first.

1. Quit all running applications.
2. When installing scanner driver (Epson Scan 2), disconnect the scanner and the computer temporarily.

Note:

Do not connect the scanner and the computer until you are instructed to do so.

3. Install the application by following the instructions on the Website below.

<http://epson.sn>

Note:

For Windows, you can also use the software disc that came with the scanner.

Adding or Replacing the Computer or Devices

Connecting to a Scanner that has been Connected to the Network.	118
Re-setting the Network Connection.	119
Checking the Network Connection Status.	121
Disabling the Network Setting from the Control Panel.	122
Restoring the Network Settings from the Control Panel.	123

Connecting to a Scanner that has been Connected to the Network

When the scanner has already been connected to the network, you can connect a computer or a smart device to the scanner over the network.

Using a Network Scanner from a Second Computer

We recommend using the installer to connect the scanner to a computer. You can run the installer using one of the following methods.

- ❑ Setting up from the website

Access the following website, and then enter the product name. Go to **Setup**, and then start setting up.

<http://epson.sn>

- ❑ Setting up using the software disc (only for the models that come with a software disc and users with Windows computers with disc drives.)

Insert the software disc into the computer, and then follow the on-screen instructions.

Selecting the Scanner

Follow the on-screen instructions until the following screen is displayed, select the scanner name you want to connect to, and then click **Next**.

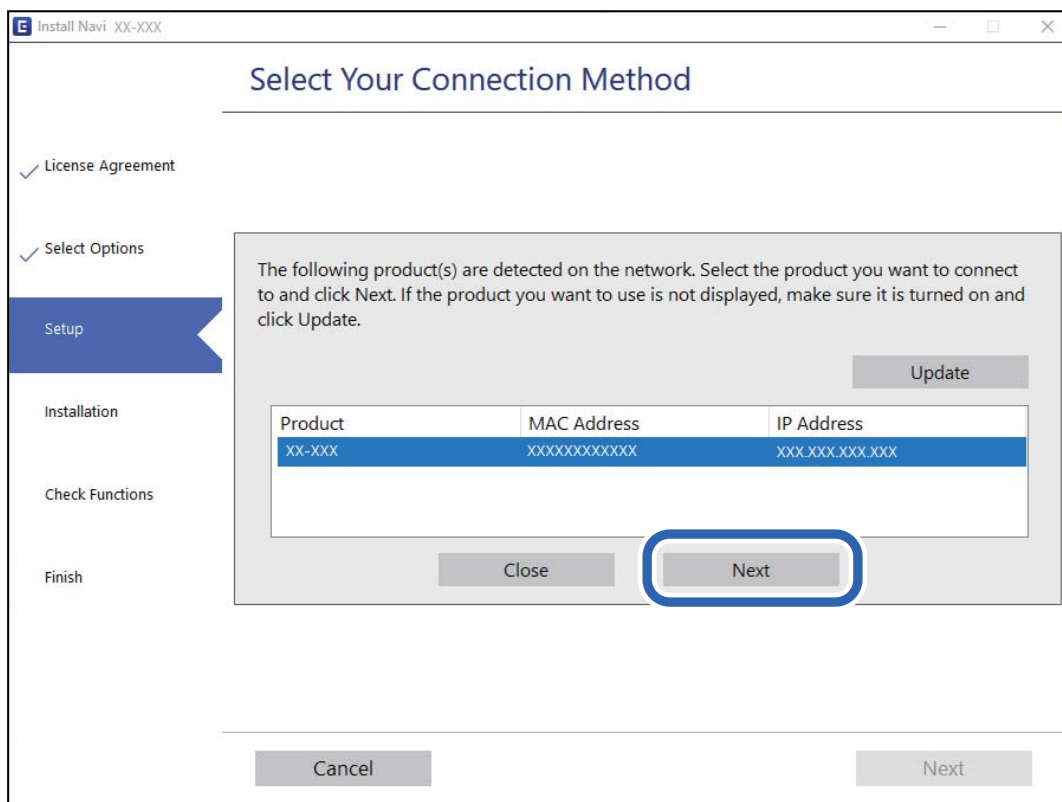

Follow the on-screen instructions.

Using a Network Scanner from a Smart Device

You can connect a smart device to the scanner using one of the following methods.

Connecting over a wireless router

Connect the smart device to the same Wi-Fi network (SSID) as the scanner.

See the following for more details.

[“Making Settings for Connecting to the Smart Device” on page 120](#)

Connecting by Wi-Fi Direct

Connect the smart device to the scanner directly without a wireless router.

See the following for more details.

[“AP Mode Connection” on page 64](#)

Re-setting the Network Connection

This section explains how to make the network connection settings and change the connection method when replacing the wireless router or the computer.

When Replacing the Wireless Router

When you replace the wireless router, make settings for the connection between the computer or the smart device and the scanner.

You need to make these settings if you change your Internet service provider and so on.

Making Settings for Connecting to the Computer

We recommend using the installer to connect the scanner to a computer. You can run the installer using one of the following methods.

- Setting up from the website

Access the following website, and then enter the product name. Go to **Setup**, and then start setting up.

<http://epson.sn>

- Setting up using the software disc (only for the models that come with a software disc and users with Windows computers with disc drives.)

Insert the software disc into the computer, and then follow the on-screen instructions.

Selecting the Connection Methods

Follow the on-screen instructions. On the **Select Your Operation** screen, select **Set up Scanner connection again (for new network router or changing USB to network, etc.)**, and then click **Next**.

Follow the on-screen instructions to finish setup.

If you cannot connect, see the following to try to solve the problem.

[“Cannot connect to a Network” on page 101](#)

Making Settings for Connecting to the Smart Device

You can use the scanner from a smart device when you connect the scanner to the same Wi-Fi network (SSID) as the smart device. To use the scanner from a smart device, access the following website, and then enter the product name. Go to **Setup**, and then start setting up.

<http://epson.sn>

Access to the website from the smart device that you want to connect to the scanner.

When Changing the Computer

When changing the computer, make connection settings between the computer and the scanner.

Making Settings for Connecting to the Computer

We recommend using the installer to connect the scanner to a computer. You can run the installer using one of the following methods.

- Setting up from the website

Access the following website, and then enter the product name. Go to **Setup**, and then start setting up.

<http://epson.sn>

- Setting up using the software disc (only for the models that come with a software disc and users with Windows computers with disc drives.)

Insert the software disc into the computer, and then follow the on-screen instructions.

Follow the on-screen instructions.

Changing the Connection Method to the Computer

This section explains how to change the connection method when the computer and the scanner have been connected.

Changing from USB to a Network Connection

Using the installer and re-set up in a different connection method.

- Setting up from the website

Access the following website, and then enter the product name. Go to **Setup**, and then start setting up.

<http://epson.sn>

- Setting up using the software disc (only for the models that come with a software disc and users with Windows computers with disc drives.)

Insert the software disc into the computer, and then follow the on-screen instructions.

Selecting Change the Connection Methods

Follow the on-screen instructions. On the **Select Your Operation** screen, select **Set up Scanner connection again (for new network router or changing USB to network, etc.)**, and then click **Next**.

Select **Connect via wireless network (Wi-Fi)**, and then click **Next**.

Follow the on-screen instructions to finish setup.

Making Wi-Fi Settings from the Control Panel

You can make network settings from the scanner's control panel in several ways. Choose the connection method that matches the environment and conditions that you are using.

If the wireless router supports WPS, you can make settings by using push button setup.

After connecting the scanner to the network, connect to the scanner from the device that you want to use (computer, smart device, tablet, and so on.)

Related Information

➔ [“Making Wi-Fi Settings from the Control Panel” on page 65](#)

Checking the Network Connection Status

You can check the network connection status in the following way.

Checking the Network Status Using Network Light

You can check the network connection status using the network light on the scanner's control panel.

Related Information

➔ [“Lights” on page 21](#)

➔ [“Error Indicators” on page 22](#)

Checking the Network of the Computer (Windows only)

By using the command prompt, check the connection status of the computer and the connection path to the scanner. This will lead you to solve the problems.

ipconfig command

Display the connection status of the network interface that is currently used by the computer.

By comparing the setting information with actual communication, you can check whether the connection is correct. In case there are multiple DHCP servers on the same network, you can find out the actual address assigned to the computer, the referred DNS server, etc.

Format : ipconfig /all

Examples :

```

Administrator: Command Prompt
c:\>ipconfig /all
Windows IP Configuration

Host Name . . . . . : WIN2012R2
Primary Dns Suffix . . . . . : pubs.net
Node Type . . . . . : Hybrid
IP Routing Enabled. . . . . : No
WINS Proxy Enabled. . . . . : No
DNS Suffix Search List. . . . . : pubs.net

Ethernet adapter Ethernet:

Connection-specific DNS Suffix . . . : Gigabit Network Connection
Description . . . . . : 
Physical Address. . . . . : XX-XX-XX-XX-XX-XX
DHCP Enabled. . . . . : No
Autoconfiguration Enabled . . . . . : Yes
Link-local IPv6 Address . . . . . : fe80::38fb:7546:18a8:d20e%14(Preferred)
IPv4 Address. . . . . : 192.168.111.10(Preferred)
Subnet Mask . . . . . : 255.255.255.0
Default Gateway . . . . . : 192.168.111.1
DHCPv6 IAID . . . . . : 283142549
DHCPv6 Client DUID. . . . . : 00-01-00-01-20-40-2F-45-00-1D-73-6A-44-08
DNS Servers . . . . . : 192.168.111.2
NetBIOS over Tcpip. . . . . : Enabled

Tunnel adapter isatap.{00000000-ABCD-EFGH-IJK-LMNOPQRSTUUV}>:

Media State . . . . . : Media disconnected
Connection-specific DNS Suffix . . . : 
Description . . . . . : Microsoft ISATAP Adapter #2
Physical Address. . . . . : 00-00-00-00-00-00-E0
DHCP Enabled. . . . . : No
Autoconfiguration Enabled . . . . . : Yes

c:\>_
    
```

pathping command

You can confirm the list of routers passing through the destination host and the routing of communication.

Format : pathping xxx.xxx.xxx.xxx

Examples : pathping 192.0.2.222

```

Administrator: Command Prompt
c:\>pathping 192.168.111.20
Tracing route to EPSONAB12AB [192.168.111.20]
over a maximum of 30 hops:
 0  WIN2012R2.pubs.net [192.168.111.10]
 1  EPSONAB12AB [192.168.111.20]

Computing statistics for 25 seconds...
Hop  RTT      Source to Here   This Node/Link   Address
 0      0/ 100 = 0%      0/ 100 = 0%      WIN2012R2.pubs.net [192.168.111.10]
 1  38ms     0/ 100 = 0%      0/ 100 = 0%      EPSONAB12AB [192.168.111.20]



Trace complete.

c:\>_
    
```

Disabling the Network Setting from the Control Panel

You can disable the network settings.

1. Press the  button for more than 3 seconds to disable a Wi-Fi and AP mode connection.







The  light and  light turn off when these are disabled.

Note:

Press the  button to re-connect Wi-Fi and AP mode.

Restoring the Network Settings from the Control Panel

You can restore all network settings to their defaults.

1. Turn the scanner off.
2. While holding down the  button, press the  button until  light and  light turn on simultaneously.
The  light and  light flash alternately and then turn off when restoration is complete.

Administrator Information

Connecting to the Network.	125
Introduction of Product Security Features.	127
Administrator Settings.	127
Monitoring a Remote Scanner.	128
Backing Up the Settings.	132
Advanced Security Settings.	134

Connecting to the Network

You can connect to the network with a static IP address by using the installer on the software disc.

Before Making Network Connection

To connect to the network, check the connection method and setting information for connection in advance.

Gathering Information on the Connection Setting

Prepare the necessary setting information to connect. Check the following information in advance.

Divisions	Items	Note
Network connection information	<input type="checkbox"/> IP address <input type="checkbox"/> Subnet mask <input type="checkbox"/> Default gateway	Decide the IP address to assign to the scanner. When you assign the IP address statically, all values are required. When you assign the IP address dynamically using the DHCP function, this information is not required because it is set automatically.
Wi-Fi connection information	<input type="checkbox"/> SSID <input type="checkbox"/> Password	These are the SSID (network name) and the password of the access point that the scanner connects to. If MAC address filtering has been set, register the MAC address of the scanner in advance to register the scanner. See the following for the supported standards. "Network Specifications" on page 167
DNS server information	<input type="checkbox"/> IP address for primary DNS <input type="checkbox"/> IP address for secondary DNS	These are required when specifying DNS servers. The secondary DNS is set when the system has a redundant configuration and there is a secondary DNS server. If you are in a small organization and do not set the DNS server, set the IP address of the router.
Proxy server information	<input type="checkbox"/> Proxy server name	Set this when your network environment uses the proxy server to access the internet from the intranet, and you use the function that the scanner directly accesses to the internet. The scanner connects directly to the Internet to update the firmware.
Port number information	<input type="checkbox"/> Port number to release	Check the port number used by the scanner and computer, then release the port that is blocked by a firewall, if necessary. See the following for the port number used by the scanner. "Using Port for the Scanner" on page 167

IP Address Assignment

These are the following types of IP address assignment.

Static IP address:

Assign the predetermined IP address to the scanner (host) manually.

The information to connect to the network (subnet mask, default gateway, DNS server and so on) need to be set manually.

The IP address does not change even when the device is turned off, so this is useful when you want to manage devices with an environment where you cannot change the IP address or you want to manage devices using the IP address. We recommend settings to the scanner, server, etc. that many computers access. Also, when using security features such as IPsec / IP filtering, assign a fixed IP address so that the IP address does not change.

Automatic assignment by using DHCP function (dynamic IP address):

Assign the IP address automatically to the scanner (host) by using the DHCP function of the DHCP server or router.

The information to connect to the network (subnet mask, default gateway, DNS server and so on) is set automatically, so you can easily connect the device to the network.

If the device or the router is turned off, or depending on the DHCP server settings, IP address may change when re-connecting.

We recommend managing devices other than the IP address and communicating with protocols that can follow the IP address.

Note:

When you use the IP address reservation function of the DHCP, you can assign the same IP address to the devices at any time.

DNS Server and Proxy Server

The DNS server has a host name, domain name of the email address, etc. in association with the IP address information.

Communication is impossible if the other party is described by host name, domain name, etc. when the computer or the scanner performs IP communication.

Queries the DNS server for that information and gets the IP address of the other party. This process is called name resolution.

Therefore, the devices such as computers and scanners can communicate using the IP address.

Name resolution is necessary for the scanner to communicate using the email function or Internet connection function.

When you use those functions, make the DNS server settings.

When you assign the scanner's IP address by using the DHCP function of the DHCP server or router, it is automatically set.

The proxy server is placed at the gateway between the network and the Internet, and it communicates to the computer, scanner, and Internet (opposite server) on behalf of each of them. The opposite server communicates only to the proxy server. Therefore, scanner information such as the IP address and port number cannot be read and increased security is expected.

When you connect to the Internet via a proxy server, configure the proxy server on the scanner.

Connecting to the Network Using a Static IP Address

Selecting a static IP address using the software installer.

1. Insert the software disc into the computer, and then follow the on-screen instructions.

Note:

*When the **Select Your Operation** screen is displayed, select the operation you want to perform. Select **Set up Scanner connection again** (for new network router or changing USB to network, etc.) and click **Next**.*

2. On the **Select Your Connection Method** screen, select **Advanced configuration**, enter the static IP address, and then follow the on-screen instructions.

Connecting to the Wireless LAN (Wi-Fi)

You can connect the scanner to the wireless LAN (Wi-Fi) in several ways. Choose the connection method that matches the environment and conditions that you are using.

If the wireless router supports WPS, you can make settings by using push button setup.

After connecting the scanner to the network, connect to the scanner from the device that you want to use (computer, smart device, tablet, and so on.)

Introduction of Product Security Features

This section introduces the security function of the Epson Devices.

Name	Feature type	What to set	What to prevent
Configuring the Administrator Password	Locks the system settings, such as connection setup for network.	An administrator sets a password to the device. You can set or change from Web Config.	Prevent from illegally reading and changing the information stored in the device such as ID, password, network settings, and so on. Also, reduce a wide range of security risks such as leakage of information for the network environment or security policy.

Administrator Settings

Configuring the Administrator Password

When you set the administrator password, you can prevent the users from changing system management settings. You can set and change the administrator password using either Web Config or Epson Device Admin. When using Epson Device Admin, see the Epson Device Admin guide or help.

Configuring the Administrator Password from a Computer

You can set the administrator password using Web Config.

1. Access Web Config and select the **Product Security** tab > **Change Administrator Password**.

2. Enter a password to **New Password** and **Confirm New Password**. Enter the user name, if necessary.
If you want to change the password to new one, enter a current password.
3. Select **OK**.

Note:

- To set or change the locked menu items, click **Administrator Login**, and then enter the administrator password.
- To delete the administrator password, click **Product Security tab > Delete Administrator Password**, and then enter the administrator password.

Related Information

➔ [“Running Web Config on a Web Browser” on page 25](#)

Logging on to the Scanner from a Computer

When you log in to Web Config as an administrator, you can operate items that are set in the Lock Setting.

1. Enter the scanner's IP address into a browser to run Web Config.
2. Click **Administrator Login**.
3. Enter the user name and administrator password in **User Name** and **Current password**.
4. Click **OK**.
The locked items and **Administrator Logout** are displayed when being authenticated.
Click **Administrator Logout** to log off.

Related Information

➔ [“Running Web Config on a Web Browser” on page 25](#)

Monitoring a Remote Scanner

Checking Information for a Remote Scanner

You can check the following information of the operating scanner from **Status** by using Web Config.

- Product Status**
Check the status, product number, MAC address, etc.
- Network Status**
Check the information of the network connection status, IP address, DNS server, etc.
- Usage Status**
Check the first day of scanning, scanning count, etc.
- Hardware Status**
Check the status of each function of the scanner.

Receiving Email Notifications When Events Occur

About Email Notifications

This is the notification function that, when events such as scanning stop and scanner error occur, send the email to the specified address.

You can register up to five destinations and set the notification settings for each destination.

To use this function, you need to set up the mail server before setting up notifications.

Configuring an Email Server

Check below before setting up.

- The scanner is connected to a network.
- The computer's email server information.

1. Access Web Config and select the **Network** tab > **Email Server** > **Basic**.
2. Enter a value for each item.
3. Select **OK**.

The settings you have selected are displayed.

Mail Server Setting Items

Items	Settings and Explanation	
Authentication Method	Specify the authentication method for the scanner to access the mail server.	
	Off	Authentication is disabled when communicating with a mail server.
	SMTP AUTH	Requires that a mail server supports SMTP Authentication.
	POP before SMTP	Configure the POP3 server when selecting this method.
Authenticated Account	If you select SMTP AUTH or POP before SMTP as the Authentication Method , enter the authenticated account name between 0 and 255 characters in ASCII (0x20-0x7E).	
Authenticated Password	If you select SMTP AUTH or POP before SMTP as the Authentication Method , enter the authenticated password between 0 and 20 characters in ASCII (0x20-0x7E).	
Sender's Email Address	Enter the sender's email address. Enter between 0 and 255 characters in ASCII (0x20-0x7E) except for : () < > [] ; ¥. A period "." cannot be the first character.	
SMTP Server Address	Enter between 0 and 255 characters using A-Z a-z 0-9 . - . You can use IPv4 or FQDN format.	
SMTP Server Port Number	Enter a number between 1 and 65535.	

Items	Settings and Explanation	
Secure Connection	Specify the secure connection method for the email server.	
	None	If you select POP before SMTP in Authentication Method , the connection method is set to None .
	SSL/TLS	This is available when Authentication Method is set to Off or SMTP AUTH .
	STARTTLS	This is available when Authentication Method is set to Off or SMTP AUTH .
Certificate Validation	The certificate is validated when this is enabled. We recommend this is set to Enable .	
POP3 Server Address	If you select POP before SMTP as the Authentication Method , enter the POP3 server address between 0 and 255 characters using A-Z a-z 0-9 . - . You can use IPv4 or FQDN format.	
POP3 Server Port Number	If you select POP before SMTP as the Authentication Method , enter a number between 1 and 65535.	

Checking a Mail Server Connection

You can check the connection to the mail server by performing the connection check.

1. Access Web Config and select the **Network** tab > **Email Server** > **Connection Test**.
2. Select **Start**.

The connection test to the mail server is started. After the test, the check report is displayed.

Mail Server Connection Test References

Messages	Cause
Connection test was successful.	This message appears when the connection with the server is successful.
SMTP server communication error. Check the following. - Network Settings	This message appears when <ul style="list-style-type: none"> <input type="checkbox"/> The scanner is not connected to a network <input type="checkbox"/> SMTP server is down <input type="checkbox"/> Network connection is disconnected while communicating <input type="checkbox"/> Received incomplete data
POP3 server communication error. Check the following. - Network Settings	This message appears when <ul style="list-style-type: none"> <input type="checkbox"/> The scanner is not connected to a network <input type="checkbox"/> POP3 server is down <input type="checkbox"/> Network connection is disconnected while communicating <input type="checkbox"/> Received incomplete data
An error occurred while connecting to SMTP server. Check the followings. - SMTP Server Address - DNS Server	This message appears when <ul style="list-style-type: none"> <input type="checkbox"/> Connecting to a DNS server failed <input type="checkbox"/> Name resolution for an SMTP server failed

Messages	Cause
An error occurred while connecting to POP3 server. Check the followings. - POP3 Server Address - DNS Server	This message appears when <input type="checkbox"/> Connecting to a DNS server failed <input type="checkbox"/> Name resolution for a POP3 server failed
SMTP server authentication error. Check the followings. - Authentication Method - Authenticated Account - Authenticated Password	This message appears when SMTP server authentication failed.
POP3 server authentication error. Check the followings. - Authentication Method - Authenticated Account - Authenticated Password	This message appears when POP3 server authentication failed.
Unsupported communication method. Check the followings. - SMTP Server Address - SMTP Server Port Number	This message appears when you try to communicate with unsupported protocols.
Connection to SMTP server failed. Change Secure Connection to None.	This message appears when an SMTP mismatch occurs between a server and a client, or when the server does not support SMTP secure connection (SSL connection).
Connection to SMTP server failed. Change Secure Connection to SSL/TLS.	This message appears when an SMTP mismatch occurs between a server and a client, or when the server requests to use an SSL/TLS connection for an SMTP secure connection.
Connection to SMTP server failed. Change Secure Connection to STARTTLS.	This message appears when an SMTP mismatch occurs between a server and a client, or when the server requests to use a STARTTLS connection for an SMTP secure connection.
The connection is untrusted. Check the following. - Date and Time	This message appears when the scanner's date and time setting is incorrect or the certificate has expired.
The connection is untrusted. Check the following. - CA Certificate	This message appears when the scanner does not have a root certificate corresponding to the server or a CA Certificate has not been imported.
The connection is not secured.	This message appears when the obtained certificate is damaged.
SMTP server authentication failed. Change Authentication Method to SMTP-AUTH.	This message appears when an authentication method mismatch occurs between a server and a client. The server supports SMTP AUTH.
SMTP server authentication failed. Change Authentication Method to POP before SMTP.	This message appears when an authentication method mismatch occurs between a server and a client. The server does not support SMTP AUTH.
Sender's Email Address is incorrect. Change to the email address for your email service.	This message appears when the specified sender's Email address is wrong.
Cannot access the product until processing is complete.	This message appears when the scanner is busy.

Configuring Email Notification

Configure email notification by using Web Config.

1. Access Web Config and select the **Device Management** tab > **Email Notification**.

2. Set the subject of email notification.

Select the contents displayed on the subject from the two pull-down menus.

- The selected contents are displayed next to **Subject**.
- The same contents cannot be set on left and right.
- When the number of characters in **Location** exceeds 32 bytes, characters exceeding 32 bytes are omitted.

3. Enter the email address for sending the notification email.

Use A-Z a-z 0-9 ! # \$ % & ' * + - . / = ? ^ _ { | } ~ @, and enter between 1 and 255 characters.

4. Select the language for the email notifications.

5. Select the check box on the event for which you want to receive a notification.

The number of **Notification Settings** is linked to the destination number of **Email Address Settings**.

Example :

If you want to send a notification to the email address set for number 1 in **Email Address Settings** when the admin password is changed, select the check box for column **1** on the line **Administrator password changed**.

6. Click **OK**.

Confirm that an email notification will be sent by causing an event.

Example : The administrator password has been changed.

Related Information

➔ [“Running Web Config on a Web Browser” on page 25](#)

Items for Email Notification

Items	Settings and Explanation
Administrator password changed	Notice when administrator password has been changed.
Scanner error	Notice when the scanner error has occurred.
Wi-Fi failure	Notice when the error of the wireless LAN interface has occurred.

Backing Up the Settings

You can export the setting value set from Web Config to the file. You can use it for backing up the setting values, replacing the scanner, etc.

The exported file cannot be edited because it is exported as a binary file.

Export the settings

Export the setting for the scanner.

1. Access Web Config, and then select the **Device Management** tab > **Export and Import Setting Value** > **Export**.

2. Select the settings that you want to export.

Select the settings you want to export. If you select the parent category, subcategories are also selected. However, subcategories that cause errors by duplicating within the same network (such as IP addresses and so on) cannot be selected.

3. Enter a password to encrypt the exported file.

You need the password to import the file. Leave this blank if you do not want to encrypt the file.

4. Click **Export**.

 **Important:**

*If you want to export the scanner's network settings such as the device name and IPv6 address, select **Enable to select the individual settings of device** and select more items. Only use the selected values for the replacement scanner.*

Related Information

- ➔ [“Running Web Config on a Web Browser” on page 25](#)

Import the settings

Import the exported Web Config file to the scanner.

 **Important:**

When importing values that include individual information such as a scanner name or IP address, make sure the same IP address does not exist on the same network.

1. Access Web Config, and then select the **Device Management** tab > **Export and Import Setting Value** > **Import**.

2. Select the exported file, and then enter the encrypted password.

3. Click **Next**.

4. Select the settings that you want to import, and then click **Next**.

5. Click **OK**.

The settings are applied to the scanner.

Related Information

- ➔ [“Running Web Config on a Web Browser” on page 25](#)

Advanced Security Settings

This section explains advanced security features.

Security Settings and Prevention of Danger

When a scanner is connected to a network, you can access it from a remote location. In addition, many people can share the scanner, which is helpful in improving operational efficiency and convenience. However, risks such as illegal access, illegal use, and tampering with data are increased. If you use the scanner in an environment where you can access the Internet, the risks are even higher.

In order to avoid this risk, Epson scanners have a variety of security technologies.

Set the scanner as necessary according to the environmental conditions that have been built with the customer's environment information.

Name	Feature type	What to set	What to prevent
Control of protocol	Controls the protocols and services to be used for communication between scanners and computers, and it enables and disables features.	A protocol or service that is applied to features allowed or prohibited separately.	Reducing security risks that may occur through unintended use by preventing users from using unnecessary functions.
SSL/TLS communications	The communication content is encrypted with SSL/TLS communications when accessing to the Epson server on the Internet from the scanner, such as communicating to the computer via web browser and updating firmware.	Obtain a CA-signed certificate, and then import it to the scanner.	Clearing an identification of the scanner by the CA-signed certification prevents impersonation and unauthorized access. In addition, communication contents of SSL/TLS are protected, and it prevents the leakage of contents for scanning data and setup information.
IPsec/IP filtering	You can set to allow severing and cutting off of data that is from a certain client or is a particular type. Since IPsec protects the data by IP packet unit (encryption and authentication), you can safely communicate unsecured protocol.	Create a basic policy and individual policy to set the client or type of data that can access the scanner.	Protect unauthorized access, and tampering and interception of communication data to the scanner.
IEEE802.1X	Only allows authenticated users to connect to the network. Allows only a permitted user to use the scanner.	Authentication setting to the RADIUS server (authentication sever).	Protect unauthorized access and use to the scanner.

Security Feature Settings

When setting IPsec/IP filtering or IEEE802.1X, it is recommended that you access Web Config using SSL/TLS to communicate settings information in order to reduce security risks such as tampering or interception.

Make sure you configure the administrator password before setting IPsec/IP filtering or IEEE802.1X.

Controlling Using Protocols

You can scan using a variety of pathways and protocols. Also, you can use network scanning from an unspecified number of network computers.

You can lower unintended security risks by restricting scanning from specific pathways or by controlling the available functions.

Controlling protocols

Configure the protocol settings supported by the scanner.

1. Access Web Config and then select the **Network Security** tab > **Protocol**.
2. Configure each item.
3. Click **Next**.
4. Click **OK**.

The settings are applied to the scanner.

Related Information

➔ [“Running Web Config on a Web Browser” on page 25](#)

Protocols you can Enable or Disable

Protocol	Description
Bonjour Settings	You can specify whether to use Bonjour. Bonjour is used to search for devices, scan, and so on.
SLP Settings	You can enable or disable the SLP function. SLP is used for push scanning and network searching in EpsonNet Config.
WSD Settings	You can enable or disable the WSD function. When this is enabled, you can add WSD devices, and scan from the WSD port.
LLTD Settings	You can enable or disable the LLTD function. When this is enabled, it is displayed on the Windows network map.
LLMNR Settings	You can enable or disable the LLMNR function. When this is enabled, you can use name resolution without NetBIOS even if you cannot use DNS.
SNMPv1/v2c Settings	You can specify whether or not to enable SNMPv1/v2c. This is used to set up devices, monitoring, and so on.
SNMPv3 Settings	You can specify whether or not to enable SNMPv3. This is used to set up encrypted devices, monitoring, etc.

Protocol Setting Items

Bonjour Settings

Items	Setting value and Description
Use Bonjour	Select this to search for or use devices through Bonjour.
Bonjour Name	Displays the Bonjour name.
Bonjour Service Name	Displays the Bonjour service name.
Location	Displays the Bonjour location name.
Wide-Area Bonjour	Set whether to use Wide-Area Bonjour.

SLP Settings

Items	Setting value and Description
Enable SLP	Select this to enable the SLP function. This is used such as network searching in EpsonNet Config.

WSD Settings

Items	Setting value and Description
Enable WSD	Select this to enable adding devices using WSD and scan from the WSD port.
Scanning Timeout (sec)	Enter the communication timeout value for WSD scanning between 3 to 3,600 seconds.
Device Name	Displays the WSD device name.
Location	Displays the WSD location name.

LLTD Settings

Items	Setting value and Description
Enable LLTD	Select this to enable LLTD. The scanner is displayed in the Windows network map.
Device Name	Displays the LLTD device name.

LLMNR Settings

Items	Setting value and Description
Enable LLMNR	Select this to enable LLMNR. You can use name resolution without NetBIOS even if you cannot use DNS.

SNMPv1/v2c Settings

Items	Setting value and Description
Enable SNMPv1/v2c	Select to enable SNMPv1/v2c.
Access Authority	Set the access authority when SNMPv1/v2c is enabled. Select Read Only or Read/Write .
Community Name (Read Only)	Enter 0 to 32 ASCII (0x20 to 0x7E) characters.
Community Name (Read/Write)	Enter 0 to 32 ASCII (0x20 to 0x7E) characters.

SNMPv3 Settings

Items	Setting value and Description
Enable SNMPv3	SNMPv3 is enabled when the box is checked.
User Name	Enter between 1 and 32 characters using 1 byte characters.
Authentication Settings	
Algorithm	Select an algorithm for an authentication for SNMPv3.
Password	Enter the password for an authentication for SNMPv3. Enter between 8 and 32 characters in ASCII (0x20-0x7E). If you do not specify this, leave it blank.
Confirm Password	Enter the password you configured for confirmation.
Encryption Settings	
Algorithm	Select an algorithm for an encryption for SNMPv3.
Password	Enter the password for an encryption for SNMPv3. Enter between 8 and 32 characters in ASCII (0x20-0x7E). If you do not specify this, leave it blank.
Confirm Password	Enter the password you configured for confirmation.
Context Name	Enter within 32 characters or less in Unicode (UTF-8). If you do not specify this, leave it blank. The number of characters that can be entered varies depending on the language.

Using a Digital Certificate

About Digital Certification

CA-signed Certificate

This is a certificate signed by the CA (Certificate Authority.) You can obtain it to apply to the Certificate Authority. This certificate certifies the existence of the scanner is and used for SSL/TLS communication so that you can ensure the safety of data communication.

When it is used for SSL/TLS communication, it is used as a server certificate.

When it is set to IPsec/IP Filtering or IEEE802.1x communication, it is used as a client certificate.

❑ CA Certificate

This is a certificate that is in chain of the CA-signed Certificate, also called the intermediate CA certificate. It is used by the web browser to validate the path of the scanner's certificate when accessing the server of the other party or Web Config.

For the CA Certificate, set when to validate the path of server certificate accessing from the scanner. For the scanner, set to certify the path of the CA-signed Certificate for SSL/TLS connection.

You can obtain the CA certificate of the scanner from the Certification Authority where the CA certificate is issued.

Also, you can obtain the CA certificate used to validate the server of the other party from the Certification Authority that issued the CA-signed Certificate of the other server.

❑ Self-signed Certificate

This is a certificate that the scanner signs and issues itself. It is also called the root certificate. Because the issuer certifies itself, it is not reliable and cannot prevent impersonation.

Use it when making the security setting and performing simple SSL/TLS communication without the CA-signed Certificate.

If you use this certificate for an SSL/TLS communication, a security alert may be displayed on a web browser because the certificate is not registered on a web browser. You can use the Self-signed Certificate only for an SSL/TLS communication.

Configuring a CA-signed Certificate

Obtaining a CA-signed Certificate

To obtain a CA-signed certificate, create a CSR (Certificate Signing Request) and apply it to certificate authority. You can create a CSR using Web Config and a computer.

Follow the steps to create a CSR and obtain a CA-signed certificate using Web Config. When creating a CSR using Web Config, a certificate is the PEM/DER format.

1. Access Web Config, and then select the **Network Security** tab. Next, select **SSL/TLS > Certificate** or **IPsec/IP Filtering > Client Certificate** or **IEEE802.1X > Client Certificate**.

Whatever you choose, you can obtain the same certificate and use it in common.

2. Click **Generate** of **CSR**.

A CSR creating page is opened.

3. Enter a value for each item.

Note:

Available key length and abbreviations vary by a certificate authority. Create a request according to rules of each certificate authority.

4. Click **OK**.

A completion message is displayed.

5. Select the **Network Security** tab. Next, select **SSL/TLS > Certificate**, or **IPsec/IP Filtering > Client Certificate** or **IEEE802.1X > Client Certificate**.

- Click one of the download buttons of CSR according to a specified format by each certificate authority to download a CSR to a computer.



Important:

Do not generate a CSR again. If you do so, you may not be able to import an issued CA-signed Certificate.

- Send the CSR to a certificate authority and obtain a CA-signed Certificate.
Follow the rules of each certificate authority on sending method and form.
- Save the issued CA-signed Certificate to a computer connected to the scanner.
Obtaining a CA-signed Certificate is complete when you save a certificate to a destination.

Related Information

➔ [“Running Web Config on a Web Browser” on page 25](#)

CSR Setting Items

Items	Settings and Explanation
Key Length	Select a key length for a CSR.
Common Name	<p>You can enter between 1 and 128 characters. If this is an IP address, it should be a static IP address. You can enter 1 to 5 IPv4 addresses, IPv6 addresses, host names, FQDNs by separating them with commas.</p> <p>The first element is stored to the common name, and other elements are stored to the alias field of the certificate subject.</p> <p>Example: Scanner's IP address : 192.0.2.123, Scanner name : EPSONA1B2C3 Common Name : EPSONA1B2C3,EPSONA1B2C3.local,192.0.2.123</p>
Organization/ Organizational Unit/ Locality/ State/Province	You can enter between 0 and 64 characters in ASCII (0x20-0x7E). You can divide distinguished names with commas.
Country	Enter a country code in two-digit number specified by ISO-3166.
Sender's Email Address	You can enter the sender's email address for the mail server setting. Enter the same email address as the Sender's Email Address for the Network tab > Email Server > Basic .

Importing a CA-signed Certificate

Import the obtained CA-signed Certificate to the scanner.



Important:

- Make sure that the scanner's date and time is set correctly. Certificate may be invalid.*
- If you obtain a certificate using a CSR created from Web Config, you can import a certificate one time.*

1. Access Web Config and then select the **Network Security** tab. Next, select **SSL/TLS > Certificate**, or **IPsec/IP Filtering > Client Certificate** or **IEEE802.1X > Client Certificate**.

2. Click **Import**

A certificate importing page is opened.

3. Enter a value for each item. Set **CA Certificate 1** and **CA Certificate 2** when verifying the path of the certificate on the web browser that accesses the scanner.

Depending on where you create a CSR and the file format of the certificate, required settings may vary. Enter values to required items according to the following.

- A certificate of the PEM/DER format obtained from Web Config
 - Private Key:** Do not configure because the scanner contains a private key.
 - Password:** Do not configure.
 - CA Certificate 1/CA Certificate 2:** Optional
- A certificate of the PEM/DER format obtained from a computer
 - Private Key:** You need to set.
 - Password:** Do not configure.
 - CA Certificate 1/CA Certificate 2:** Optional
- A certificate of the PKCS#12 format obtained from a computer
 - Private Key:** Do not configure.
 - Password:** Optional
 - CA Certificate 1/CA Certificate 2:** Do not configure.

4. Click **OK**.

A completion message is displayed.

Note:

Click **Confirm** to verify the certificate information.

Related Information

➔ [“Running Web Config on a Web Browser” on page 25](#)

CA-signed Certificate Importing Setting Items

Items	Settings and Explanation
Server Certificate or Client Certificate	Select a certificate's format. For SSL/TLS connection, the Server Certificate is displayed. For IPsec/IP Filtering or IEEE802.1x, the Client Certificate is displayed.
Private Key	If you obtain a certificate of the PEM/DER format by using a CSR created from a computer, specify a private key file that is match a certificate.
Password	If the file format is Certificate with Private Key (PKCS#12) , enter the password for encrypting the private key that is set when you obtain the certificate.

Items	Settings and Explanation
CA Certificate 1	If your certificate's format is Certificate (PEM/DER) , import a certificate of a certificate authority that issues a CA-signed Certificate used as server certificate. Specify a file if you need.
CA Certificate 2	If your certificate's format is Certificate (PEM/DER) , import a certificate of a certificate authority that issues CA Certificate 1. Specify a file if you need.

Deleting a CA-signed Certificate

You can delete an imported certificate when the certificate has expired or when an encrypted connection is no longer necessary.



Important:

If you obtain a certificate using a CSR created from Web Config, you cannot import a deleted certificate again. In this case, create a CSR and obtain a certificate again.

1. Access Web Config, and then select the **Network Security** tab. Next, select **SSL/TLS > Certificate** or **IPsec/IP Filtering > Client Certificate** or **IEEE802.1X > Client Certificate**.
2. Click **Delete**.
3. Confirm that you want to delete the certificate in the message displayed.

Related Information

➔ [“Running Web Config on a Web Browser” on page 25](#)

Updating a Self-signed Certificate

Because the Self-signed Certificate is issued by the scanner, you can update it when it has expired or when the content described changes.

1. Access Web Config and select the **Network Security** tab > **SSL/TLS > Certificate**.
2. Click **Update**.
3. Enter **Common Name**.

You can enter up to 5 IPv4 addresses, IPv6 addresses, host names, FQDNs between 1 to 128 characters and separating them with commas. The first parameter is stored to the common name, and the others are stored to the alias field for the subject of the certificate.

Example:

Scanner's IP address : 192.0.2.123, Scanner name : EPSONA1B2C3

Common name : EPSONA1B2C3,EPSONA1B2C3.local,192.0.2.123

4. Specify a validity period for the certificate.

5. Click **Next**.

A confirmation message is displayed.

6. Click **OK**.

The scanner is updated.

Note:

You can check the certificate information from **Network Security tab > SSL/TLS > Certificate > Self-signed Certificate** and click **Confirm**.

Related Information

➔ [“Running Web Config on a Web Browser” on page 25](#)

Configuring a CA Certificate

When you set the CA Certificate, you can validate the path to the CA certificate of the server that the scanner accesses. This can prevent impersonation.

You can obtain the CA Certificate from the Certification Authority where the CA-signed Certificate is issued.

Importing a CA Certificate

Import the CA Certificate to the scanner.

1. Access Web Config and then select the **Network Security tab > CA Certificate**.
2. Click **Import**.
3. Specify the CA Certificate you want to import.
4. Click **OK**.

When importing is complete, you are returned to the **CA Certificate** screen, and the imported CA Certificate is displayed.

Related Information

➔ [“Running Web Config on a Web Browser” on page 25](#)

Deleting a CA Certificate

You can delete the imported CA Certificate.

1. Access Web Config and then select the **Network Security tab > CA Certificate**.
2. Click **Delete** next to the CA Certificate that you want to delete.
3. Confirm that you want to delete the certificate in the message displayed.
4. Click **Reboot Network**, and then check that the deleted CA Certificate is not listed on the updated screen.

Related Information

➔ [“Running Web Config on a Web Browser” on page 25](#)

SSL/TLS Communication with the Scanner

When the server certificate is set using SSL/TLS (Secure Sockets Layer/Transport Layer Security) communication to the scanner, you can encrypt the communication path between computers. Do this if you want to prevent remote and unauthorized access.

Configuring Basic SSL/TLS Settings

If the scanner supports the HTTPS server feature, you can use an SSL/TLS communication to encrypt communications. You can configure and manage the scanner using Web Config while ensuring security.

Configure encryption strength and redirect feature.

1. Access Web Config and select the **Network Security** tab > **SSL/TLS** > **Basic**.
2. Select a value for each item.
 - Encryption Strength
Select the level of encryption strength.
 - Redirect HTTP to HTTPS
Redirect to HTTPS when HTTP is accessed.
3. Click **Next**.
A confirmation message is displayed.
4. Click **OK**.
The scanner is updated.

Related Information

➔ [“Running Web Config on a Web Browser” on page 25](#)

Configuring a Server Certificate for the Scanner

1. Access Web Config and select the **Network Security** tab > **SSL/TLS** > **Certificate**.
2. Specify a certificate to use on **Server Certificate**.
 - Self-signed Certificate
A self-signed certificate has been generated by the scanner. If you do not obtain a CA-signed certificate, select this.
 - CA-signed Certificate
If you obtain and import a CA-signed certificate in advance, you can specify this.

3. Click **Next**.
A confirmation message is displayed.
4. Click **OK**.
The scanner is updated.

Related Information

➔ [“Running Web Config on a Web Browser” on page 25](#)

Encrypted Communication Using IPsec/IP Filtering

About IPsec/IP Filtering

You can filter traffic based on IP addresses, services, and port by using IPsec/IP Filtering function. By combining of the filtering, you can configure the scanner to accept or block specified clients and specified data. Additionally, you can improve security level by using an IPsec.

Note:

Computers that run Windows Vista or later or Windows Server 2008 or later support IPsec.

Configuring Default Policy

To filter traffic, configure the default policy. The default policy applies to every user or group connecting to the scanner. For more fine-grained control over users and groups of users, configure group policies.

1. Access Web Config and then select the **Network Security** tab > **IPsec/IP Filtering** > **Basic**.
2. Enter a value for each item.
3. Click **Next**.
A confirmation message is displayed.
4. Click **OK**.
The scanner is updated.

Related Information

➔ [“Running Web Config on a Web Browser” on page 25](#)

Default Policy Setting Items

Default Policy

Items	Settings and Explanation
IPsec/IP Filtering	You can enable or disable an IPsec/IP Filtering feature.

Access Control

Configure a control method for traffic of IP packets.

Items	Settings and Explanation
Permit Access	Select this to permit configured IP packets to pass through.
Refuse Access	Select this to refuse configured IP packets to pass through.
IPsec	Select this to permit configured IPsec packets to pass through.

IKE Version

Select **IKEv1** or **IKEv2** for **IKE Version**. Select one of them according to the device that the scanner is connected to.

IKEv1

The following items are displayed when you select **IKEv1** for **IKE Version**.

Items	Settings and Explanation
Authentication Method	To select Certificate , you need to obtain and import a CA-signed certificate in advance.
Pre-Shared Key	If you select Pre-Shared Key for Authentication Method , enter a pre-shared key between 1 and 127 characters.
Confirm Pre-Shared Key	Enter the key you configured for confirmation.

IKEv2

The following items are displayed when you select **IKEv2** for **IKE Version**.

Items	Settings and Explanation	
Local	Authentication Method	To select Certificate , you need to obtain and import a CA-signed certificate in advance.
	ID Type	If you select Pre-Shared Key for Authentication Method , select the type of ID for the scanner.
	ID	Enter the scanner's ID that matches the type of ID. You cannot use "@", "#", and "=" for the first character. Distinguished Name : Enter 1 to 255 1-byte ASCII (0x20 to 0x7E) characters. You need to include "=". IP Address : Enter IPv4 or IPv6 format. FQDN : Enter a combination of between 1 and 255 characters using A-Z, a-z, 0-9, "-", and period (.). Email Address : Enter 1 to 255 1-byte ASCII (0x20 to 0x7E) characters. You need to include "@". Key ID : Enter 1 to 255 1-byte ASCII (0x20 to 0x7E) characters.
	Pre-Shared Key	If you select Pre-Shared Key for Authentication Method , enter a pre-shared key between 1 and 127 characters.
	Confirm Pre-Shared Key	Enter the key you configured for confirmation.

Items		Settings and Explanation
Remote	Authentication Method	To select Certificate , you need to obtain and import a CA-signed certificate in advance.
	ID Type	If you select Pre-Shared Key for Authentication Method , select the type of ID for the device that you want to authenticate.
	ID	Enter the scanner's ID that matches to the type of ID. You cannot use "@", "#", and "=" for the first character. Distinguished Name : Enter 1 to 255 1-byte ASCII (0x20 to 0x7E) characters. You need to include "=". IP Address : Enter IPv4 or IPv6 format. FQDN : Enter a combination of between 1 and 255 characters using A-Z, a-z, 0-9, "-", and period (.). Email Address : Enter 1 to 255 1-byte ASCII (0x20 to 0x7E) characters. You need to include "@". Key ID : Enter 1 to 255 1-byte ASCII (0x20 to 0x7E) characters.
	Pre-Shared Key	If you select Pre-Shared Key for Authentication Method , enter a pre-shared key between 1 and 127 characters.
	Confirm Pre-Shared Key	Enter the key you configured for confirmation.

Encapsulation

If you select **IPsec** for **Access Control**, you need to configure an encapsulation mode.

Items	Settings and Explanation
Transport Mode	If you only use the scanner on the same LAN, select this. IP packets of layer 4 or later are encrypted.
Tunnel Mode	If you use the scanner on the Internet-capable network such as IPsec-VPN, select this option. The header and data of the IP packets are encrypted. Remote Gateway(Tunnel Mode) : If you select Tunnel Mode for Encapsulation , enter a gateway address between 1 and 39 characters.

Security Protocol

If you select **IPsec** for **Access Control**, select an option.

Items	Settings and Explanation
ESP	Select this to ensure the integrity of an authentication and data, and encrypt data.
AH	Select this to ensure the integrity of an authentication and data. Even if encrypting data is prohibited, you can use IPsec.

❑ Algorithm Settings

It is recommended that you select **Any** for all settings or select an item other than **Any** for each setting. If you select **Any** for some of the settings and select an item other than **Any** for the other settings, the device may not communicate depending on the other device that you want to authenticate.

Items		Settings and Explanation
IKE	Encryption	Select the encryption algorithm for IKE. The items vary depending on the version of IKE.
	Authentication	Select the authentication algorithm for IKE.
	Key Exchange	Select the key exchange algorithm for IKE. The items vary depending on the version of IKE.
ESP	Encryption	Select the encryption algorithm for ESP. This is available when ESP is selected for Security Protocol .
	Authentication	Select the authentication algorithm for ESP. This is available when ESP is selected for Security Protocol .
AH	Authentication	Select the encryption algorithm for AH. This is available when AH is selected for Security Protocol .

Configuring Group Policy

A group policy is one or more rules applied to a user or user group. The scanner controls IP packets that match with configured policies. IP packets are authenticated in the order of a group policy 1 to 10 then a default policy.

1. Access Web Config and then select the **Network Security** tab > **IPsec/IP Filtering** > **Basic**.
2. Click a numbered tab you want to configure.
3. Enter a value for each item.
4. Click **Next**.
A confirmation message is displayed.
5. Click **OK**.
The scanner is updated.

Group Policy Setting Items

Items	Settings and Explanation
Enable this Group Policy	You can enable or disable a group policy.

Access Control

Configure a control method for traffic of IP packets.

Items	Settings and Explanation
Permit Access	Select this to permit configured IP packets to pass through.
Refuse Access	Select this to refuse configured IP packets to pass through.
IPsec	Select this to permit configured IPsec packets to pass through.

Local Address (Scanner)

Select an IPv4 address or IPv6 address that matches your network environment. If an IP address is assigned automatically, you can select **Use auto-obtained IPv4 address**.

Note:

If an IPv6 address is assigned automatically, the connection may be unavailable. Configure a static IPv6 address.

Remote Address(Host)

Enter a device's IP address to control access. The IP address must be 43 characters or less. If you do not enter an IP address, all addresses are controlled.

Note:

If an IP address is assigned automatically (e.g. assigned by DHCP), the connection may be unavailable. Configure a static IP address.

Method of Choosing Port

Select a method to specify ports.

- Service Name

If you select **Service Name** for **Method of Choosing Port**, select an option.

- Transport Protocol

If you select **Port Number** for **Method of Choosing Port**, you need to configure an encapsulation mode.

Items	Settings and Explanation
Any Protocol	Select this to control all protocol types.
TCP	Select this to control data for unicast.
UDP	Select this to control data for broadcast and multicast.
ICMPv4	Select this to control ping command.

- Local Port

If you select **Port Number** for **Method of Choosing Port** and if you select **TCP** or **UDP** for **Transport Protocol**, enter port numbers to control receiving packets, separating them with commas. You can enter 10 port numbers at the maximum.

Example: 20,80,119,5220

If you do not enter a port number, all ports are controlled.

- Remote Port

If you select **Port Number** for **Method of Choosing Port** and if you select **TCP** or **UDP** for **Transport Protocol**, enter port numbers to control sending packets, separating them with commas. You can enter 10 port numbers at the maximum.

Example: 25,80,143,5220

If you do not enter a port number, all ports are controlled.

IKE Version

Select **IKEv1** or **IKEv2** for **IKE Version**. Select one of them according to the device that the scanner is connected to.

IKEv1

The following items are displayed when you select **IKEv1** for **IKE Version**.

Items	Settings and Explanation
Authentication Method	If you select IPsec for Access Control , select an option. Used certificate is common with a default policy.
Pre-Shared Key	If you select Pre-Shared Key for Authentication Method , enter a pre-shared key between 1 and 127 characters.
Confirm Pre-Shared Key	Enter the key you configured for confirmation.

❑ IKEv2

The following items are displayed when you select **IKEv2** for **IKE Version**.

Items		Settings and Explanation
Local	Authentication Method	If you select IPsec for Access Control , select an option. Used certificate is common with a default policy.
	ID Type	If you select Pre-Shared Key for Authentication Method , select the type of ID for the scanner.
	ID	Enter the scanner's ID that matches the type of ID. You cannot use "@", "#", and "=" for the first character. Distinguished Name : Enter 1 to 255 1-byte ASCII (0x20 to 0x7E) characters. You need to include "=". IP Address : Enter IPv4 or IPv6 format. FQDN : Enter a combination of between 1 and 255 characters using A-Z, a-z, 0-9, "-", and period (.). Email Address : Enter 1 to 255 1-byte ASCII (0x20 to 0x7E) characters. You need to include "@". Key ID : Enter 1 to 255 1-byte ASCII (0x20 to 0x7E) characters.
	Pre-Shared Key	If you select Pre-Shared Key for Authentication Method , enter a pre-shared key between 1 and 127 characters.
	Confirm Pre-Shared Key	Enter the key you configured for confirmation.
Remote	Authentication Method	If you select IPsec for Access Control , select an option. Used certificate is common with a default policy.
	ID Type	If you select Pre-Shared Key for Authentication Method , select the type of ID for the device that you want to authenticate.
	ID	Enter the scanner's ID that matches to the type of ID. You cannot use "@", "#", and "=" for the first character. Distinguished Name : Enter 1 to 255 1-byte ASCII (0x20 to 0x7E) characters. You need to include "=". IP Address : Enter IPv4 or IPv6 format. FQDN : Enter a combination of between 1 and 255 characters using A-Z, a-z, 0-9, "-", and period (.). Email Address : Enter 1 to 255 1-byte ASCII (0x20 to 0x7E) characters. You need to include "@". Key ID : Enter 1 to 255 1-byte ASCII (0x20 to 0x7E) characters.
	Pre-Shared Key	If you select Pre-Shared Key for Authentication Method , enter a pre-shared key between 1 and 127 characters.
	Confirm Pre-Shared Key	Enter the key you configured for confirmation.

Encapsulation

If you select **IPsec** for **Access Control**, you need to configure an encapsulation mode.

Items	Settings and Explanation
Transport Mode	If you only use the scanner on the same LAN, select this. IP packets of layer 4 or later are encrypted.
Tunnel Mode	If you use the scanner on the Internet-capable network such as IPsec-VPN, select this option. The header and data of the IP packets are encrypted. Remote Gateway(Tunnel Mode): If you select Tunnel Mode for Encapsulation , enter a gateway address between 1 and 39 characters.

Security Protocol

If you select **IPsec** for **Access Control**, select an option.

Items	Settings and Explanation
ESP	Select this to ensure the integrity of an authentication and data, and encrypt data.
AH	Select this to ensure the integrity of an authentication and data. Even if encrypting data is prohibited, you can use IPsec.

Algorithm Settings

It is recommended that you select **Any** for all settings or select an item other than **Any** for each setting. If you select **Any** for some of the settings and select an item other than **Any** for the other settings, the device may not communicate depending on the other device that you want to authenticate.

Items		Settings and Explanation
IKE	Encryption	Select the encryption algorithm for IKE. The items vary depending on the version of IKE.
	Authentication	Select the authentication algorithm for IKE.
	Key Exchange	Select the key exchange algorithm for IKE. The items vary depending on the version of IKE.
ESP	Encryption	Select the encryption algorithm for ESP. This is available when ESP is selected for Security Protocol .
	Authentication	Select the authentication algorithm for ESP. This is available when ESP is selected for Security Protocol .
AH	Authentication	Select the encryption algorithm for AH. This is available when AH is selected for Security Protocol .

Combination of Local Address (Scanner) and Remote Address(Host) on Group Policy

	Setting of Local Address (Scanner)		
	IPv4	IPv6* ²	Any addresses* ³

Setting of Remote Address(Host)	IPv4* ¹	✓	–	✓
	IPv6* ^{1*2}	–	✓	✓
	Blank	✓	✓	✓

*1If **IPsec** is selected for **Access Control**, you cannot specify a prefix length.

*2If **IPsec** is selected for **Access Control**, you can select a link-local address (fe80::) but group policy will be disabled.

*3Except IPv6 link local addresses.

Related Information

➔ [“Running Web Config on a Web Browser” on page 25](#)

References of Service Name on Group Policy

Note:

Unavailable services are displayed but cannot be selected.

Service Name	Protocol type	Local port number	Remote port number	Features controlled
Any	–	–	–	All services
ENPC	UDP	3289	Any port	Searching for a scanner from applications such as Epson Device Admin and the a scanner driver
SNMP	UDP	161	Any port	Acquiring and configuring of MIB from applications such as Epson Device Admin and the Epson scanner driver
WSD	TCP	Any port	5357	Controlling WSD
WS-Discovery	UDP	3702	Any port	Searching for a scanner from WSD
Network Scan	TCP	1865	Any port	Forwarding scan data from Epson ScanSmart
Network Push Scan Discovery	UDP	2968	Any port	Searching for a computer from scanner
Network Push Scan	TCP	Any port	2968	Acquiring job information of push scanning from Epson ScanSmart
HTTP (Local)	TCP	80	Any port	HTTP(S) server (forwarding data of Web Config and WSD)
HTTPS (Local)	TCP	443	Any port	
HTTP (Remote)	TCP	Any port	80	HTTP(S) client (firmware updating and root certificate updating)
HTTPS (Remote)	TCP	Any port	443	

Configuration Examples of IPsec/IP Filtering

Receiving IPsec packets only

This example is to configure a default policy only.

Default Policy:

- IPsec/IP Filtering: Enable**
- Access Control: IPsec**
- Authentication Method: Pre-Shared Key**
- Pre-Shared Key:** Enter up to 127 characters.

Group Policy: Do not configure.

Receiving scanning data and scanner settings

This example allows communications of scanning data and scanner configuration from specified services.

Default Policy:

- IPsec/IP Filtering: Enable**
- Access Control: Refuse Access**

Group Policy:

- Enable this Group Policy:** Check the box.
- Access Control: Permit Access**
- Remote Address(Host):** IP address of a client
- Method of Choosing Port: Service Name**
- Service Name:** Check the box of ENPC, SNMP, HTTP (Local), HTTPS (Local) and Network Scan.

Receiving access from a specified IP address only

This example allows a specified IP address to access the scanner.

Default Policy:

- IPsec/IP Filtering: Enable**
- Access Control: Refuse Access**

Group Policy:

- Enable this Group Policy:** Check the box.
- Access Control: Permit Access**
- Remote Address(Host):** IP address of an administrator's client

Note:

Regardless of policy configuration, the client will be able to access and configure the scanner.

Configuring a Certificate for IPsec/IP Filtering

Configure the Client Certificate for IPsec/IP Filtering. When you set it, you can use the certificate as an authentication method for IPsec/IP Filtering. If you want to configure the certification authority, go to **CA Certificate**.

1. Access Web Config and then select the **Network Security** tab > **IPsec/IP Filtering** > **Client Certificate**.
2. Import the certificate in **Client Certificate**.

If you have already imported a certificate published by a Certification Authority, you can copy the certificate and use it in IPsec/IP Filtering. To copy, select the certificate from **Copy From**, and then click **Copy**.

Related Information

➔ [“Running Web Config on a Web Browser” on page 25](#)

Connecting the Scanner to an IEEE802.1X Network

Configuring an IEEE802.1X Network

When you set IEEE802.1X to the scanner, you can use it on the network connected to a RADIUS server, a LAN switch with authentication function, or an access point.

1. Access Web Config and then select the **Network Security** tab > **IEEE802.1X** > **Basic**.

2. Enter a value for each item.

If you want to use the scanner on a Wi-Fi network, click **Wi-Fi Setup** and select or enter an SSID.

3. Click **Next**.

A confirmation message is displayed.

4. Click **OK**.

The scanner is updated.

IEEE802.1X Network Setting Items

Items	Settings and Explanation
IEEE802.1X (Wi-Fi)	The connection status of IEEE802.1X (Wi-Fi) is displayed.
Connection Method	The connection method of a current network is displayed.

Items	Settings and Explanation	
EAP Type	Select an option for an authentication method between the scanner and a RADIUS server.	
	EAP-TLS	You need to obtain and import a CA-signed certificate.
	PEAP-TLS	
	PEAP/MSCHAPv2	You need to configure a password.
	EAP-TTLS	
User ID	Configure an ID to use for an authentication of a RADIUS server. Enter 1 to 128 1-byte ASCII (0x20 to 0x7E) characters.	
Password	Configure a password to authenticate the scanner. Enter 1 to 128 1-byte ASCII (0x20 to 0x7E) characters. If you are using a Windows server as a RADIUS server, you can enter up to 127 characters.	
Confirm Password	Enter the password you configured for confirmation.	
Server ID	You can configure a server ID to authenticate with a specified RADIUS server. Authenticator verifies whether a server ID is contained in the subject/subjectAltName field of a server certificate that is sent from a RADIUS server or not. Enter 0 to 128 1-byte ASCII (0x20 to 0x7E) characters.	
Certificate Validation	You can set certificate validation regardless of the authentication method. Import the certificate in CA Certificate .	
Anonymous Name	If you select PEAP-TLS or PEAP/MSCHAPv2 for EAP Type , you can configure an anonymous name instead of a user ID for a phase 1 of a PEAP authentication. Enter 0 to 128 1-byte ASCII (0x20 to 0x7E) characters.	
Encryption Strength	You can select one of the followings.	
	High	AES256/3DES
	Middle	AES256/3DES/AES128/RC4

Configuring a Certificate for IEEE802.1X

Configure the Client Certificate for IEEE802.1X. When you set it, you can use **EAP-TLS** and **PEAP-TLS** as an authentication method of IEEE802.1x. If you want to configure the certification authority certificate, go to **CA Certificate**.

1. Access Web Config and then select the **Network Security** tab > **IEEE802.1X** > **Client Certificate**.
2. Enter a certificate in the **Client Certificate**.

If you have already imported a certificate published by a Certification Authority, you can copy the certificate and use it in IEEE802.1X. To copy, select the certificate from **Copy From**, and then click **Copy**.

Solving Problems for Advanced Security

Hints to Solving Problems

Checking the error message

When trouble has occurred, first check whether there are any messages on the driver screen. If you have the notification email set when the events occur, you can promptly learn the status.

Checking the communication status

Check the communication status of server computer or client computer by using the command such as ping and ipconfig.

Connection test

For checking the connection between the scanner to the mail server, perform the connection test from the scanner. Also, check the connection from the client computer to the server to check the communication status.

Initializing the settings

If the settings and communication status show no problem, the problems may be solved by disabling or initializing the network settings of the scanner, and then setting up again.

Related Information

➔ [“Buttons” on page 20](#)

➔ [“Receiving Email Notifications When Events Occur” on page 129](#)

Cannot Access Web Config

■ The IP address is not assigned to the scanner.

Solutions

A valid IP address may not be assigned to the scanner. Set a valid IP address using Epson Scan 2 Utility. You can confirm the current setting information from Epson Scan 2 Utility.

➔ [“Checking the Scanner's IP Address” on page 67](#)

■ Web browser does not support the Encryption Strength for SSL/TLS.

Solutions

SSL/TLS has the Encryption Strength. You can open Web Config by using a web browser that supports bulk encryptions as indicated below. Check you are using the a supported browser.

80bit: AES256/AES128/3DES

112bit: AES256/AES128/3DES

128bit: AES256/AES128

192bit: AES256

256bit: AES256

■ CA-signed Certificate is expired.

Solutions

If there is a problem with the expiration date of the certificate, "The certificate has expired" is displayed when connecting to Web Config with SSL/TLS communication (https). If the message appears before its expiration date, make sure that the scanner's date is configured correctly.

■ The common name of the certificate and the scanner do not match.

Solutions

If the common name of the certificate and the scanner do not match, the message "The name of the security certificate does not match..." is displayed when accessing Web Config using SSL/TLS communication (https). This happens because the following IP addresses do not match.

- The scanner's IP address entered to common name for creating a Self-signed Certificate or CSR
- IP address entered to web browser when running Web Config

For Self-signed Certificate, update the certificate.

For CA-signed Certificate, take the certificate again for the scanner.

■ The proxy server setting of local address is not set to web browser.

Solutions

When the scanner is set to use a proxy server, configure the web browser not to connect to the local address via the proxy server.

- Windows :

Select **Control Panel > Network and Internet > Internet Options > Connections > LAN settings > Proxy server**, and then configure not to use the proxy server for LAN (local addresses).

- Mac OS :

Select **System Preferences > Network > Advanced > Proxies**, and then register the local address for **Bypass proxy settings for these Hosts & Domains**.

Example:

192.168.1.*: Local address 192.168.1.XXX, subnet mask 255.255.255.0

192.168.*.*: Local address 192.168.XXX.XXX, subnet mask 255.255.0.0

Restoring the Security Settings

When you establish a highly secure environment such as IPsec/IP Filtering or IEEE802.1X, you may not be able to communicate with devices because of incorrect settings or trouble with the device or server. In this case, restore the security settings in order to make settings for the device again or to allow you temporary use.

Disabling the Security Function Using Web Config

You can disable IPsec/IP Filtering using Web Config.

1. Access Web Config and select the **Network Security** tab > **IPsec/IP Filtering > Basic**.
2. Disable the **IPsec/IP Filtering**.

Problems Using Network Security Features

Forgot a Pre-shared Key

Re-configure a pre-shared key.

To change the key, access Web Config and select the **Network Security** tab > **IPsec/IP Filtering** > **Basic** > **Default Policy** or **Group Policy**.

When you change the pre-shared key, configure the pre-shared key for computers.

Cannot Communicate with IPsec Communication

Specify the algorithm that the scanner or the computer does not support.

The scanner supports the following algorithms. Check the settings of the computer.

Security Methods	Algorithms
IKE encryption algorithm	AES-CBC-128, AES-CBC-192, AES-CBC-256, AES-GCM-128*, AES-GCM-192*, AES-GCM-256*, 3DES
IKE authentication algorithm	SHA-1, SHA-256, SHA-384, SHA-512, MD5
IKE key exchange algorithm	DH Group1, DH Group2, DH Group5, DH Group14, DH Group15, DH Group16, DH Group17, DH Group18, DH Group19, DH Group20, DH Group21, DH Group22, DH Group23, DH Group24, DH Group25, DH Group26, DH Group27*, DH Group28*, DH Group29*, DH Group30*
ESP encryption algorithm	AES-CBC-128, AES-CBC-192, AES-CBC-256, AES-GCM-128, AES-GCM-192, AES-GCM-256, 3DES
ESP authentication algorithm	SHA-1, SHA-256, SHA-384, SHA-512, MD5
AH authentication algorithm	SHA-1, SHA-256, SHA-384, SHA-512, MD5

*available for IKEv2 only

Cannot Communicate Suddenly

There is an error in the certificate.

The scanner's date and time settings may be incorrect if power has not been supplied to the scanner for a long time.

When the scanner is connected using a client certificate for IPsec/IP filtering or IEEE802.1X, an error is indicated if a time lag occurs between the scanner's date and time and the validity period for the certificate. Because the scanner recognizes that the certificate is unavailable.

You can solve this problem by correcting the scanner's date and time settings. Connect the scanner and the computer using a USB cable, turn the scanner on, and then perform scanning over USB using Epson Scan 2. The scanner is synchronized with the computer and the date and time settings are corrected. The scanner indicates normal status.

If you cannot solve the problem, restore all network settings using the scanner's control panel. Connect the scanner and computer, make the network settings again, and then make the settings for client certification, IPsec/IP filtering, or IEEE802.1X.

The IP address of the scanner has been changed or cannot be used.

When the IP address registered to the local address on Group Policy has been changed or cannot be used, IPsec communication cannot be performed.

Restore all network settings using the scanner's control panel.

If the DHCP is out of date, rebooting or the IPv6 address is out of date or has not been obtained, then the IP address registered for the scanner's Web Config (**Network Security** tab > **IPsec/IP Filtering** > **Basic** > **Group Policy** > **Local Address (Scanner)**) may not be found.

Use a static IP address.

The IP address of the computer has been changed or cannot be used.

When the IP address registered to the remote address on Group Policy has been changed or cannot be used, IPsec communication cannot be performed.

Restore all network settings using the scanner's control panel.

If the DHCP is out of date, rebooting or the IPv6 address is out of date or has not been obtained, then the IP address registered for the scanner's Web Config (**Network Security** tab > **IPsec/IP Filtering** > **Basic** > **Group Policy** > **Remote Address(Host)**) may not be found.

Use a static IP address.

Cannot Connect After Configuring IPsec/IP Filtering

The set value may be incorrect.

Access the scanner according to its MAC address using EpsonNet Config or Epson Device Admin from another computer, such as administrator's. You can find the MAC address on the label pasted on the scanner.

If you can access, make the IPsec/IP filtering settings using EpsonNet Config or Epson Device Admin.

If you cannot access, restore all network settings using the scanner's control panel. Connect the scanner and computer, make the network settings again, and then make the IPsec/IP filtering settings.

Cannot Access the Scanner after Configuring IEEE802.1X

The settings may be incorrect.

Restore all network settings using the scanner's control panel. Connect the scanner and computer, make the network settings again, and then configure IEEE802.1X.

Problems on Using a Digital Certificate

Cannot Import a CA-signed Certificate

CA-signed Certificate and the information on the CSR do not match.

If the CA-signed Certificate and CSR do not have the same information, the CSR cannot be imported. Check the following:

- Are you trying to import the certificate to a device that does not have the same information?
Check the information of the CSR and then import the certificate to a device that has the same information.
- Did you overwrite the CSR saved into the scanner after sending the CSR to a certificate authority?
Obtain the CA-signed certificate again with the CSR.

CA-signed Certificate is more than 5KB.

You cannot import a CA-signed Certificate that is more than 5KB.

The password for importing the certificate is incorrect.

Enter the correct password. If you forget the password, you cannot import the certificate. Re-obtain the CA-signed Certificate.

Cannot Update a Self-Signed Certificate

The Common Name has not been entered.

Common Name must be entered.

Unsupported characters have been entered to Common Name.

Enter between 1 and 128 characters of either IPv4, IPv6, host name, or FQDN format in ASCII (0x20-0x7E).

A comma or space is included in the common name.

If a comma is entered, the **Common Name** is divided at that point. If only a space is entered before or after a comma, an error occurs.

Cannot Create a CSR

The Common Name has not been entered.

The **Common Name** must be entered.

Unsupported characters have been entered to Common Name, Organization, Organizational Unit, Locality, and State/Province.

Enter characters of either IPv4, IPv6, host name, or FQDN format in ASCII (0x20-0x7E).

A comma or space is included in the Common Name.

If a comma is entered, the **Common Name** is divided at that point. If only a space is entered before or after a comma, an error occurs.

Warning Relating to a Digital Certificate Appears

Messages	Cause/What to do
Enter a Server Certificate.	<p>Cause: You have not selected a file to import.</p> <p>What to do: Select a file and click Import.</p>
CA Certificate 1 is not entered.	<p>Cause: CA certificate 1 is not entered and only CA certificate 2 is entered.</p> <p>What to do: Import CA certificate 1 first.</p>
Invalid value below.	<p>Cause: Unsupported characters are contained in the file path and/or password.</p> <p>What to do: Make sure that the characters are entered correctly for the item.</p>
Invalid date and time.	<p>Cause: Date and time for the scanner have not been set.</p> <p>What to do: Set date and time using Web Config or EpsonNet Config.</p>
Invalid password.	<p>Cause: The password set for CA certificate and entered password do not match.</p> <p>What to do: Enter the correct password.</p>

Messages	Cause/What to do
<p>Invalid file.</p>	<p>Cause: You are not importing a certificate file in X509 format.</p> <p>What to do: Make sure that you are selecting the correct certificate sent by a trusted certificate authority.</p>
	<p>Cause: The file you have imported is too large. The maximum file size is 5KB.</p> <p>What to do: If you select the correct file, the certificate might be corrupted or fabricated.</p>
	<p>Cause: The chain contained in the certificate is invalid.</p> <p>What to do: For more information on the certificate, see the website of the certificate authority.</p>
<p>Cannot use the Server Certificates that include more than three CA certificates.</p>	<p>Cause: The certificate file in PKCS#12 format contains more than 3 CA certificates.</p> <p>What to do: Import each certificate as converting from PKCS#12 format to PEM format, or import the certificate file in PKCS#12 format that contains up to 2 CA certificates.</p>
<p>The certificate has expired. Check if the certificate is valid, or check the date and time on the product.</p>	<p>Cause: The certificate is out of date.</p> <p>What to do:</p> <ul style="list-style-type: none"> <input type="checkbox"/> If the certificate is out of date, obtain and import the new certificate. <input type="checkbox"/> If the certificate is not out of date, make sure the scanner's date and time are set correctly.
<p>Private key is required.</p>	<p>Cause: There is no paired private key with the certificate.</p> <p>What to do:</p> <ul style="list-style-type: none"> <input type="checkbox"/> If the certificate is the PEM/DER format and it is obtained from a CSR using a computer, specify the private key file. <input type="checkbox"/> If the certificate is the PKCS#12 format and it is obtained from a CSR using a computer, create a file that contains the private key.
	<p>Cause: You have re-imported the PEM/DER certificate obtained from a CSR using Web Config.</p> <p>What to do: If the certificate is the PEM/DER format and it is obtained from a CSR using Web Config, you can only import it once.</p>

Messages	Cause/What to do
Setup failed.	<p>Cause: Cannot finish the configuration because the communication between the scanner and computer failed or the file cannot be read by some errors.</p> <p>What to do: After checking the specified file and communication, import the file again.</p>

Delete a CA-signed Certificate by Mistake

There is no backup file for the CA-signed certificate.

If you have the backup file, import the certificate again.

If you obtain a certificate using a CSR created from Web Config, you cannot import a deleted certificate again. Create a CSR and obtain a new certificate.

Technical Specifications

General Scanner Specifications.	166
Network Specifications.	167
Using Port for the Scanner.	167
Dimensions and Weight Specifications.	168
Electrical Specifications.	168
Environmental Specifications.	169
System Requirements.	170

General Scanner Specifications

Note:

Specifications are subject to change without notice.

Scanner type	Sheet Feed, one pass duplex color scanner
Photoelectric device	CIS
Effective pixels	5,100×9,300 at 600 dpi 2,550×64,500 at 300 dpi
Light source	RGB LED
Scanning resolution	600 dpi (main scan) 600 dpi (sub scan)
Output resolution	50 to 1200 dpi (in 1 dpi increments)* ¹
Document Size	Max: 215.9×6,096 mm (8.5×240 inches) Min: 50.8×50.8 mm (2×2 inches)
Paper input	Face-down loading
Paper output	Face-down ejection
Paper capacity	50 sheets of paper at 80 g/m ²
Color Depth	<p>Color</p> <ul style="list-style-type: none"> <input type="checkbox"/> 30 bits per pixel internal (10 bits per pixel per color internal) <input type="checkbox"/> 24 bits per pixel external (8 bits per pixel per color external) <p>Grayscale</p> <ul style="list-style-type: none"> <input type="checkbox"/> 10 bits per pixel internal <input type="checkbox"/> 8 bits per pixel external <p>Black and white</p> <ul style="list-style-type: none"> <input type="checkbox"/> 10 bits per pixel internal <input type="checkbox"/> 1 bit per pixel external
Interface* ²	SuperSpeed USB IEEE802.11b/g/n

*1 You can scan long paper in the following resolutions.

- 1,346.0 mm (53 in.) or less: up to 600 dpi
- 5,461.0 mm (215 in.) or less: up to 300 dpi
- 6,096.0 mm (220 in.) or less: up to 200 dpi

*2 You cannot use a USB and network connection at the same time.

Network Specifications

Wi-Fi Specifications

Standards	IEEE802.11b/g/n
Frequency Range	2.4 GHz
Maximum Radio-Frequency Power Transmitted	20 dBm (EIRP)
Connection Modes	Infrastructure mode, Ad hoc mode *1, AP mode *2 *3
Wireless Security	WEP (64/128bit), WPA2-PSK (AES)*4, WPA2-Enterprise *5, WPA3-SAE, WPA3-Enterprise

*1 Not supported for IEEE802.11n.

*2 Not supported for IEEE802.11b.

*3 AP mode connection and Wi-Fi connection can be used at the same time.

*4 Complies with WPA2 standards with support for WPA/WPA2 Personal.

*5 Complies with WPA2 standards with support for WPA/WPA2 Enterprise.

Network Function List

Functions		Supported
Panel Operation	Restore the Factory Default Settings	✓
Network Scanning	Epson Scan 2	IPv4, IPv6
	Epson ScanSmart	IPv4

Security Protocol

SSL/TLS	HTTPS (Server/Client), SMTPS (Client), STARTTLS, Root certificate (Client), Root certificate updating (Client), CA-signed certificate (Server), CA certificate (Server), CSR generation (Server), Self-signed certificate (Server), EC key CSR/self-signed certificate generation (Server), Certificates/Secret key imports (Server)
Authentication for Email sending	POP before SMTP, APOP, SMTP Authentication
MIB accessing Authentication/Encryption	SNMPv3

Using Port for the Scanner

The scanner uses the following port. These ports should be allowed to become available by the network administrator as necessary.

Sender (Client)	Use	Destination (Server)	Protocol	Port Number
Scanner	Control WSD	Client computer	WSD (TCP)	5357
	Search the computer when push scanning from Epson ScanSmart	Client computer	Network Push Scan Discovery	2968
	HTTP(S) client (firmware updating and root certificate updating)	Client computer	HTTP	80
			HTTPS	443
Client computer	Discover the scanner from an application such as EpsonNet Config and scanner driver.	Scanner	ENPC (UDP)	3289
	Collect and set up the MIB information from an application such as EpsonNet Config and scanner driver.	Scanner	SNMP (UDP)	161
	Searching WSD scanner	Scanner	WS-Discovery (UDP)	3702
	Forwarding scan data from the Epson ScanSmart	Scanner	Network Scan (TCP)	1865
	Acquiring job information of push scanning from the Epson ScanSmart	Scanner	Network Push Scan	2968
	HTTP(S) server (forwarding data of Web Config and WSD)	Scanner	HTTP	80
			HTTPS	443

Dimensions and Weight Specifications

Dimensions *	Width: 296 mm (11.7 inches) Depth: 169 mm (6.7 inches) Height: 176 mm (6.9 inches)
Weight	Approx. 3.7 kg (8.2 lb)

* Without protruding parts and the input tray.

Electrical Specifications

Scanner Electrical Specifications

Rated DC Input Power Supply Voltage	DC 24 V
Rated DC Input Current	1 A

Power Consumption	<p>USB Connection</p> <ul style="list-style-type: none"> <input type="checkbox"/> Operating: Approx. 11 W <input type="checkbox"/> Ready mode: Approx. 5.4 W <input type="checkbox"/> Sleep mode : Approx. 1.0 W <input type="checkbox"/> Power off: Approx. 0.1 W <p>Wi-Fi Connection</p> <ul style="list-style-type: none"> <input type="checkbox"/> Operating: Approx. 12 W <input type="checkbox"/> Ready mode: Approx. 5.5 W <input type="checkbox"/> Sleep mode : Approx. 1.3 W <input type="checkbox"/> Power off: Approx. 0.1 W
-------------------	---

Note:

For European users, see the following Website for details on power consumption.

<http://www.epson.eu/energy-consumption>

AC Adapter Electrical Specifications

Model	A461H (AC 100-240 V) A462E (AC 220-240 V)
Rated Input Current	1 A
Rated Frequency Range	50-60 Hz
Rated Output Power Supply Voltage	DC 24 V
Rated Output Current	1 A

Note:

For European users, see the following Website for details on power consumption.

<http://www.epson.eu/energy-consumption>

Environmental Specifications

Temperature	When operating	5 to 35 °C (41 to 95 °F)
	When stored	-25 to 60 °C (-13 to 140 °F)
Humidity	When operating	15 to 80% (without condensation)
	When stored	15 to 85% (without condensation)
Operating conditions		Ordinary office or home conditions. Avoid operating the scanner in direct sunlight, near a strong light source, or in extremely dusty conditions.

System Requirements

Supported operating systems may vary depending on the application.

Windows	Windows 10 (32-bit, 64-bit) Windows 8.1 (32-bit, 64-bit) Windows 8 (32-bit, 64-bit) Windows 7 (32-bit, 64-bit)
Mac OS*1 *2	macOS Catalina macOS Mojave macOS High Sierra macOS Sierra OS X El Capitan OS X Yosemite *3

*1 Fast User Switching on Mac OS or later is not supported.

*2 The UNIX File System (UFS) for Mac OS is not supported.

*3 Epson ScanSmart does not support OS X Yosemite.

Standards and Approvals

Standards and Approvals for European Models.	172
Standards and Approvals for U.S. Models.	172

Standards and Approvals for European Models

Product and AC adapter

For European users

Hereby, Seiko Epson Corporation declares that the following radio equipment models are in compliance with Directive 2014/53/EU. The full text of the EU declaration of conformity is available at the following website.

<http://www.epson.eu/conformity>

J382E

A461H, A462E

For use only in Ireland, UK, Austria, Germany, Liechtenstein, Switzerland, France, Belgium, Luxembourg, Netherlands, Italy, Portugal, Spain, Denmark, Finland, Norway, Sweden, Iceland, Croatia, Cyprus, Greece, Slovenia, Malta, Bulgaria, Czech, Estonia, Hungary, Latvia, Lithuania, Poland, Romania, and Slovakia.

Epson cannot accept responsibility for any failure to satisfy the protection requirements resulting from a non-recommended modification of the product.



Standards and Approvals for U.S. Models

Product

EMC	FCC Part 15 Subpart B Class B CAN ICES-3 (B)/NMB-3 (B)
-----	---

This equipment contains the following wireless module.

Manufacturer: FOXCONN ELECTRONICS INC

Type: J26H006

This product conforms to Part 15 of the FCC Rules and RSS-210 of the IC Rules. Epson cannot accept responsibility for any failure to satisfy the protection requirements resulting from a non-recommended modification of the product. Operation is subject to the following two conditions: (1) this device may not cause harmful interference, and (2) this device must accept any interference received, including interference that may cause undesired operation of the device.

To prevent radio interference to the licensed service, this device is intended to be operated indoors and away from windows to provide maximum shielding. Equipment (or its transmit antenna) that is installed outdoors is subject to licensing.

This equipment complies with FCC/IC radiation exposure limits set forth for an uncontrolled environment and meets the FCC radio frequency (RF) Exposure Guidelines in Supplement C to OET65 and RSS-102 of the IC radio frequency (RF) Exposure rules. This equipment should be installed and operated so that the radiator is kept at least 7.9 inches (20 cm) or more away from a person's body (excluding extremities: hands, wrists, feet and ankles).

AC adapter (A461H)

Safety	UL60950-1 CAN/CSA-C22.2 No.60950-1
EMC	FCC Part 15 Subpart B Class B CAN ICES-3 (B)/NMB-3 (B)



Where to Get Help

Technical Support Web Site.	175
Contacting Epson Support.	175

Technical Support Web Site

If you need further help, visit the Epson support website shown below. Select your country or region and go to the support section of your local Epson website. The latest drivers, FAQs, manuals, or other downloadables are also available from the site.

<http://support.epson.net/>

<http://www.epson.eu/support> (Europe)

If your Epson product is not operating properly and you cannot solve the problem, contact Epson support services for assistance.

Contacting Epson Support

Before Contacting Epson

If your Epson product is not operating properly and you cannot solve the problem using the troubleshooting information in your product manuals, contact Epson support services for assistance. If Epson support for your area is not listed below, contact the dealer where you purchased your product.

Epson support will be able to help you much more quickly if you give them the following information:

- Product serial number
(The serial number label is usually on the back of the product.)
- Product model
- Product software version
(Click **About**, **Version Info**, or a similar button in the product software.)
- Brand and model of your computer
- Your computer operating system name and version
- Names and versions of the software applications you normally use with your product

Note:

Depending on the product, the dial list data for fax and/or network settings may be stored in the product's memory. Due to breakdown or repair of a product, data and/or settings may be lost. Epson shall not be responsible for the loss of any data, for backing up or recovering data and/or settings even during a warranty period. We recommend that you make your own backup data or take notes.

Help for Users in Europe

Check your Pan-European Warranty Document for information on how to contact Epson support.

Help for Users in Taiwan

Contacts for information, support, and services are:

World Wide Web

<http://www.epson.com.tw>

Information on product specifications, drivers for download, and products enquiry are available.

Epson HelpDesk

Phone: +886-2-80242008

Our HelpDesk team can help you with the following over the phone:

- Sales enquiries and product information
- Product usage questions or problems
- Enquiries on repair service and warranty

Repair service center:

<http://www.tekcare.com.tw/branchMap.page>

TekCare corporation is an authorized service center for Epson Taiwan Technology & Trading Ltd.

Help for Users in Singapore

Sources of information, support, and services available from Epson Singapore are:

World Wide Web

<http://www.epson.com.sg>

Information on product specifications, drivers for download, Frequently Asked Questions (FAQ), Sales Enquiries, and Technical Support via e-mail are available.

Epson HelpDesk

Toll Free: 800-120-5564

Our HelpDesk team can help you with the following over the phone:

- Sales enquiries and product information
- Product usage questions or problem troubleshooting
- Enquiries on repair service and warranty

Help for Users in Thailand

Contacts for information, support, and services are:

World Wide Web

<http://www.epson.co.th>

Information on product specifications, drivers for download, Frequently Asked Questions (FAQ), and e-mail are available.

Epson Call Centre

Phone: 66-2685-9899

Email: support@eth.epson.co.th

Our Call Centre team can help you with the following over the phone:

- Sales enquiries and product information
- Product usage questions or problems
- Enquiries on repair service and warranty

Help for Users in Vietnam

Contacts for information, support, and services are:

Epson Service Center

65 Truong Dinh Street, District 1, Ho Chi Minh City, Vietnam.

Phone(Ho Chi Minh City): 84-8-3823-9239, 84-8-3825-6234

29 Tue Tinh, Quan Hai Ba Trung, Hanoi City, Vietnam

Phone(Hanoi City): 84-4-3978-4785, 84-4-3978-4775

Help for Users in Indonesia

Contacts for information, support, and services are:

World Wide Web

<http://www.epson.co.id>

- Information on product specifications, drivers for download
- Frequently Asked Questions (FAQ), Sales Enquiries, questions through e-mail

Epson Hotline

Phone: +62-1500-766

Fax: +62-21-808-66-799

Our Hotline team can help you with the following over the phone or fax:

- Sales enquiries and product information
- Technical support

Epson Service Center

Province	Company Name	Address	Phone E-mail
DKI JAKARTA	ESS JAKARTA MANGGADUA	Ruko Mall Mangga Dua No. 48 Jl. Arteri Mangga Dua, Jakarta Utara - DKI JAKARTA	(+6221) 62301104 jkt-admin@epson-indonesia.co.id

Province	Company Name	Address	Phone E-mail
NORTH SUMATERA	ESC MEDAN	Jl. Bambu 2 Komplek Graha Niaga Nomor A-4, Medan - North Sumatera	(+6261) 42066090 / 42066091 mdn-adm@epson-indonesia.co.id
WEST JAWA	ESC BANDUNG	Jl. Cihampelas No. 48 A Bandung Jawa Barat 40116	(+6222) 4207033 bdg-admin@epson-indonesia.co.id
DI YOGYAKARTA	ESC YOGYAKARTA	YAP Square, Block A No. 6 Jl. C Simanjutak Yogyakarta - DIY	(+62274) 581065 ygy-admin@epson-indonesia.co.id
EAST JAWA	ESC SURABAYA	Hitech Mall Lt. 2 Block A No. 24 Jl. Kusuma Bangsa No. 116 - 118 Surabaya - JATIM	(+6231) 5355035 sby-admin@epson-indonesia.co.id
SOUTH SULAWESI	ESC MAKASSAR	Jl. Cendrawasih NO. 3A, kunjung mae, mariso, MAKASSAR - SULSEL 90125	(+62411) 8911071 mksr-admin@epson-indonesia.co.id
WEST KALIMANTAN	ESC PONTIANAK	Komp. A yani Sentra Bisnis G33, Jl. Ahmad Yani - Pontianak Kalimantan Barat	(+62561) 735507 / 767049 pontianak-admin@epson-indonesia.co.id
RIAU	ESC PEKANBARU	Jl. Tuanku Tambusai No.459A Pekanbaru Riau	(+62761) 8524695 pkb-admin@epson-indonesia.co.id
DKI JAKARTA	ESS JAKARTA SUDIRMAN	Wisma Keiai Lt. 1 Jl. Jenderal Sudirman Kav. 3 Jakarta Pusat - DKI JAKARTA 10220	(+6221) 5724335 ess@epson-indonesia.co.id
EAST JAWA	ESS SURABAYA	Ruko Surya Inti Jl. Jawa No 2-4 Kav. 29 Surabaya - Jawa Timur	(+6231) 5014949 esssby@epson-indonesia.co.id
BANTEN	ESS SERPONG	Ruko Mall WTC Matahari No. 953, Serpong-Banten	(+6221) 53167051 / 53167052 esstag@epson-indonesia.co.id
CENTRAL JAWA	ESS SEMARANG	Komplek Ruko Metro Plaza Block C20 Jl. MT Haryono No 970 Semarang - JAWA TENGAH	(+6224) 8313807 / 8417935 esssmg@epson-indonesia.co.id
EAST KALIMANTAN	ESC SAMARINDA	Jl. KH. Wahid Hasyim (M. Yamin) Kelurahan Sempaja Selatan Kecamatan Samarinda UTARA - SAMARINDA - KALTIM	(+62541) 7272904 escsmd@epson-indonesia.co.id
SOUTH SUMATERA	ESC PALEMBANG	Jl. H.M Rasyid Nawawi No. 249 Kelurahan 9 Ilir Palembang Sumatera Selatan	(+62711) 311330 escplg@epson-indonesia.co.id
EAST JAVA	ESC JEMBER	JL. Panglima Besar Sudirman Ruko no.1D Jember-Jawa Timur (Depan Balai Penelitian & Pengolahan Kakao)	(+62331) 488373 / 486468 jmr-admin@epson-indonesia.co.id
NORTH SULAWESI	ESC MANADO	Tekno Megamall Lt LG 11 TK 21, Kawasan Megamas Boulevard, Jl Piere Tendean, Manado - SULUT 95111	(+62431) 8890996 MND-ADMIN@EPSON-INDONESIA.CO.ID

For other cities not listed here, call the Hot Line: 08071137766.

Help for Users in Hong Kong

To obtain technical support as well as other after-sales services, users are welcome to contact Epson Hong Kong Limited.

Internet Home Page

<http://www.epson.com.hk>

Epson Hong Kong has established a local home page in both Chinese and English on the Internet to provide users with the following information:

- Product information
- Answers to Frequently Asked Questions (FAQs)
- Latest versions of Epson product drivers

Technical Support Hotline

You can also contact our technical staff at the following telephone and fax numbers:

Phone: 852-2827-8911

Fax: 852-2827-4383

Help for Users in Malaysia

Contacts for information, support, and services are:

World Wide Web

<http://www.epson.com.my>

- Information on product specifications, drivers for download
- Frequently Asked Questions (FAQ), Sales Enquiries, questions through e-mail

Epson Call Centre

Phone: +60 1800-8-17349

- Sales enquiries and product information
- Product usage questions or problems
- Enquiries on repair services and warranty

Head Office

Phone: 603-56288288

Fax: 603-5628 8388/603-5621 2088

Help for Users in India

Contacts for information, support, and services are:

World Wide Web

<http://www.epson.co.in>

Information on product specifications, drivers for download, and products enquiry are available.

Helpline

- Service, product information, and ordering consumables (BSNL Lines)

Toll-free number: 18004250011

Accessible 9am to 6pm, Monday through Saturday (Except public holidays)

- Service (CDMA & Mobile Users)

Toll-free number: 186030001600

Accessible 9am to 6pm, Monday through Saturday (Except public holidays)

Help for Users in the Philippines

To obtain technical support as well as other after sales services, users are welcome to contact the Epson Philippines Corporation at the telephone, fax numbers and e-mail address below:

World Wide Web

<http://www.epson.com.ph>

Information on product specifications, drivers for download, Frequently Asked Questions (FAQ), and E-mail Enquiries are available.

Epson Philippines Customer Care

Toll Free: (PLDT) 1-800-1069-37766

Toll Free: (Digital) 1-800-3-0037766

Metro Manila: (+632)441-9030

Web Site: <https://www.epson.com.ph/contact>

E-mail: customercare@epc.epson.com.ph

Accessible 9am to 6pm, Monday through Saturday (Except public holidays)

Our Customer Care team can help you with the following over the phone:

- Sales enquiries and product information
- Product usage questions or problems
- Enquiries on repair service and warranty

Epson Philippines Corporation

Trunk Line: +632-706-2609

Fax: +632-706-2663