

A85

2MP Outdoor Zoom Dome with D/N, Adaptive IR, Extreme WDR, ELLS, 4.3x Zoom Lens



- 2 Megapixel
- Day & Night with Extreme Low Light Sensitivity and Adaptive IR LED
- 4.3x Zoom Lens with f2.8-12/F1.4-F2.8, Auto focus (for installation)
- Extreme WDR
- H.265 Compression
- Wide Angle
- Event trigger, response and notification

► Specifications

Device

Product Type	Zoom Dome
Maximum Resolution	2MP
Application Environment	Outdoor
Image Sensor	Progressive Scan CMOS
Sensor Size	1/2.8 "
Effective Pixels	1945(H) X 1097(V) (2.13 MP)
Day / Night	Yes
Low Light Sensitivity	Extreme
Color to B/W Switch	ISP based switch, configurable
Mechanical IR Cut Filter	Yes
IR Sensitivity Range	700-1150nm
IR LED	Adaptive IR LED
IR Working Distance	30m
Electronic Shutter	1/5-1/64000 second (manual mode); 1/5-1/64000 second (auto mode)
Horizontal Resolution (TV Lines)	1000 TVL

Lens

Focal Length	Zoom, f2.8-12mm
Aperture	F1.4-F2.8
Zoom Ratio	4.3x optical
Zoom Application	Camera Installation
Iris	Adaptive iris
Focus	Auto focus
Lens Mount	Board mount
Horizontal Viewing Angle	92° - 34.8°
Vertical Viewing Angle	49.3° - 19.8°

Video

Compression	H.265, H.264 (Main profile), MJPEG
Maximum Frame Rate vs. Resolution	30 fps at 1920 x 1080 30 fps at 1280 x 960 30 fps at 1280 x 720 30 fps at 800 x 600 30 fps at 720 x 480 30 fps at 640 x 480 30 fps at 320 x 240
Multi-Streaming	Simultaneous triple streams based on three configurations
Bit Rate Mode	Constant, Variable
Wide Dynamic Range	Extreme WDR (142 dB)
Image Enhancement	White Balance, Brightness, Backlight compensation (BLC), Contrast, Saturation, Sharpness, Automatic gain control, Flickerless, Digital Image Stabilizer (DIS, EIS), Defogging
Digital Noise Reduction	2D + 3D DNR
Privacy Mask	4 configurable regions
Text Overlay	Yes
On-Screen Graphics	Yes
Built-in Analytics	Tampering Detection
Server-based Analytics	Object Line Counting, People Counting, Face Detection, Object Based Motion Detection, Tamper, Object Line Crossing Detection, Object Enter Area Detection, Missing Object Detection, Unattended Object Detection, Smoke Detection, Heat Map, Dwell Time, Direction Detection, Automatic License Plate Recognition, People Queue Detection, (Require PC-based or standalone IVS or ALPR Server. Contact ACTi support for recommendations on how to maximize analytical accuracy)
Image Orientation	Flip, Mirror, Rotation

Audio

Audio Type	2-way, Mic-in, Line-in, Line-out
Audio Compression	8 kHz, Mono, G.711

Network

Network Protocol & Service	IPv4/v6, TCP, UDP, DHCP, PPPoE, HTTP, HTTPS, DNS, DDNS, NTP, RTP, RTSP, RTCP, SMTP, FTP, IGMP, ICMP, ARP, Bonjour, UPnP, QoS, SNMP, IEEE 802.1X
Ethernet Port	1 x Ethernet (10/100 Base-T), RJ-45 pigtail connector
Security	IP address filtering, HTTPS encryption, Password protected user level, Anonymous login

Video Analytics

Analysis Source Type	Video
----------------------	-------

Event

Event Trigger	Video motion detection (3 regions), External device through digital input, Sound detection, Tampering detection
Event Response	Notify control center, Change camera settings, Command other devices, E-mail notification with snapshots, Play the audio file, Push notification to mobile device, Save video to local storage, Upload video to NVR server, Upload video or snapshot to FTP server, Activate external device through digital output

Integration

Unified Solution	Fully compatible with ACTi software
ONVIF Compliant	Yes, Profile S, Profile G, Profile T, Profile Q
Web Browser	IE 11
Auto Firmware Upgrade	Yes

Interface

Local Storage	MicroSDHC, MicroSDXC memory card slot (card not included)
Digital Input/Output	1/1 (Terminal block)

General

Power Source	DC 12V, PoE Class 3 (IEEE802.3af)
Power Consumption	12.95 W (PoE)
Dimensions	(Ø x H): 139.38mm x 129.75mm (5.48" x 5.10")
Environmental Casing	Weatherproof (IP66), Vandal proof (IK10)
Mount Type	Surface, Pendant, Wall Mount
Starting Temperature	-20°C ~ 50°C (-4°F ~ 122°F)
Operating Temperature	-40°C ~ 50°C (-40°F ~ 122°F)
Operating Humidity	20% - 80% RH
Approvals	CE Class A, FCC Class A, IP66, IK10
Warranty	3 Year(s). For extended warranty offering, see http://www.acti.com/support/warranty

► Photo Indication



- 1 Input and Output Connector
 - DC 12V Power Input
 - Digital Input / Output
 - Audio Input / Output
 - Analog Video Output
- 2 Reset Button
- 3 Memory Card Slot
- 4 Ethernet Port



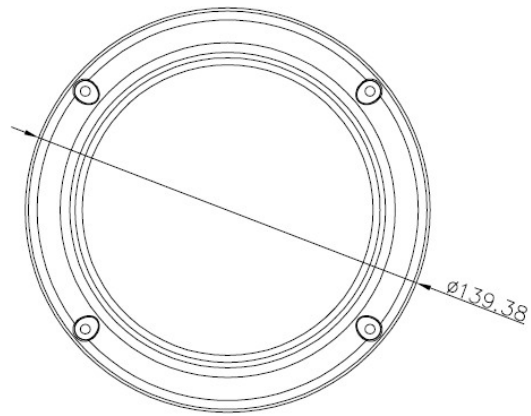
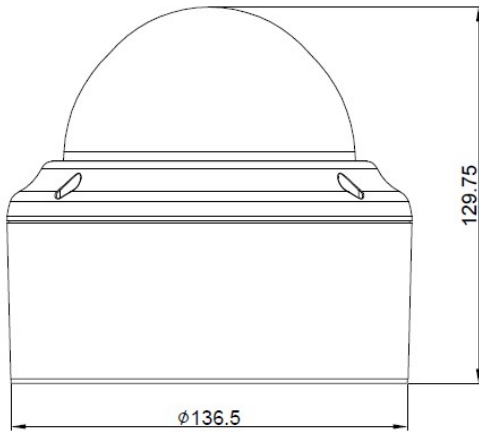









► Dimension Diagram



Unit: mm [inch]

▶ Related Products

Mounting Accessories - Camera Mount

PMAX-0104		Extension Tube
PMAX-0113		Pendant Mount (for A8x, except A88)
PMAX-0114		Mount Kit for Dome Cameras (for A8x, except A88)
PMAX-0302		Gooseneck with Bracket
PMAX-0321		Heavy Duty Wall Mount for Outdoor Domes (for A8x, except A88)
PMAX-0333		Wall Mount (for A8x, except A88)
PMAX-0511		Pole Mount (for A8x), supports 5.25" to 8.5" Poles
PMAX-0702		Junction Box for PTZ and Dome Cameras
PMAX-0704		Junction Box (for A4x, B4x, B41x, E44, E45, E46, E48, E44A, E45A, E46A, E41x, I4x, PMAX-0203~PMAX-0205)
PMAX-0810		Mount Kit and Converter Ring, 1.5" NPT for Third-Party Mounting Accessories (for A8x, except A88)
PMAX-0813		Gang Box Converter (for A8x, except A88), supports Two-Gang Boxes
PMAX-1027		Flush Mount (for A61, A62, A8x, except A88)

Note: Some mounting accessories may need additional accessories for installation. Please check www.acti.com/mountingselector for more information.

Dome Covers - Transparent Dome Cover

R701-70009		Transparent Dome Cover Only (for A8x-10A)
------------	---	---