



# Outdoor Hemispheric Dome Hardware Manual

B74, B74A, B76, B76A, B77, B77A,  
B78, I71, I73



2019/05/08

# Table of Contents

## **Precautions 4**

---

Safety Instructions .....	6
---------------------------	---

## **Introduction 7**

---

The List of Models .....	7
Package Contents.....	8
Physical Description .....	9
Mounting Solutions .....	13

## **Installing the Camera on a Surface 14**

---

Step 1: Drill the Holes.....	14
Step 2: Open the Camera Cover .....	16
Step 3: Prepare to Waterproof and Connect the Cable .....	18
Waterproof Solution with Naked Cable .....	19
Waterproof Solution with Conduit.....	21
Step 4: Install the Camera to the Surface .....	24
Step 5: Connect Camera to Network.....	24
Step 6: Access the Camera Live View.....	25
Step 7: Close the Cover .....	25

## **Other Connections 26**

---

Connecting a Power Adapter (Optional) .....	26
Connecting DI/DO Devices (Optional).....	28
Connecting Audio In / Out Devices (Optional) .....	31

## **Other Adjustments and Accessories 32**

---

How to Rotate the Viewing Orientation.....	32
How to Install / Remove the Memory Card .....	33
How to Insert the Memory Card .....	33
How to Remove the Memory Card.....	33

How to Replace the Dome Cover..... 34

## **Accessing the Camera** **36**

---

Configure the IP Addresses..... 36

Access the Camera..... 40

# Precautions

## **Read these instructions**

Read all the safety and operating instructions before using this product.

## **Heed all warnings**

Adhere to all the warnings on the product and in the instruction manual. Failure to follow the safety instructions given may directly endanger people, cause damage to the system or to other equipment.

## **Servicing**

Do not attempt to service this product yourself as opening or removing covers may expose you to dangerous voltage or other hazards. Refer all servicing to qualified service personnel.

## **Trademarks**

ACTi and ACTi logo are registered trademarks of ACTi Corporation. All other names and products used in this manual are registered trademarks of their respective companies.

## **Liability**

Every reasonable care has been taken during the writing of this manual. Please inform your local office if you find any inaccuracies or omissions. ACTi will not be held responsible for any typographical or technical errors and reserves the right to make changes to the product and manuals without prior notice.

### Federal Communications Commission Statement



This equipment has been tested and found to comply with the limits for a class B digital device, pursuant to Part 15 of the FCC Rules. These limits are designed to provide reasonable protection against harmful interference in a residential installation. This equipment generates, uses, and can radiate radio frequency energy and, if not installed and used in accordance with the instructions, may cause harmful interference to radio communications. However, there is no guarantee that interference will not occur in a particular installation. If this equipment does cause harmful interference to radio or television reception, which can be determined by turning the equipment off and on, the user is encouraged to try to correct the interference by one or more of the following measures:

- Reorient or relocate the receiving antenna.
- Increase the separation between the equipment and receiver.
- Connect the equipment into an outlet on a circuit different from that to which the receiver is connected.
- Consult the dealer or an experienced radio/TV technician for help.

**Warning:** Changes or modifications to the equipment that are not expressly approved by the responsible party for compliance could void the user's authority to operate the equipment.

### European Community Compliance Statement



This product has been tested and found to comply with the limits for Class B Information Technology Equipment according to European Standard EN 55022 and EN 55024. In a domestic environment, this product may cause radio interference in which cause the user may be required to take adequate measures.

## Safety Instructions

---

### **Cleaning**

Disconnect this product from the power supply before cleaning.

### **Accessories and Repair Parts**

Use only the accessories and repair parts recommended by the manufacturer. Using other attachments not recommended by the manufacturer may cause hazards.

### **Installation**

Install other devices (such as PoE injector, alarm, etc.) that will be used with the camera in a dry place protected from weather.

### **Servicing**

Do not attempt to service this product yourself. Refer all servicing to qualified service personnel.

### **Damage Requiring service**

Disconnect this product from the power supply immediately and refer servicing to qualified service personnel under the following conditions.

- 1) When the power-supply cord or plug is damaged
- 2) If liquid has been spilled, or objects have fallen into the product.
- 3) If the inner parts of product have been directly exposed to rain or water.
- 4) If the product does not operate normally even by following the operating instructions in this manual. Adjust only those controls that are covered by the instruction manual, as improper adjustment of other controls may result in damage, and will often require extensive work by a qualified technician to restore the product to its normal operation.









### **Safety Check**

Upon completion of any service or repairs to this product, ask the service technician to perform safety checks to determine if the product is in proper operating condition.

# Introduction

## The List of Models

This hardware manual contains the following models:

B74		8MP Video Analytics Outdoor Hemispheric Dome with D/N Adaptive IR, Extreme WDR, SLLS, Fixed lens (Discontinued)
B74A		8MP Video Analytics Outdoor Hemispheric Dome with D/N Adaptive IR, Extreme WDR, SLLS, Fixed lens
B76		12MP Video Analytics Outdoor Hemispheric Dome with D/N Adaptive IR, Extreme WDR, SLLS, Fixed lens (Discontinued)
B76A		12MP Video Analytics Outdoor Hemispheric Dome with D/N Adaptive IR, Extreme WDR, SLLS, Fixed lens
B77		6MP Video Analytics Outdoor Hemispheric Dome with D/N, Adaptive IR, Extreme WDR, SLLS, Fixed lens (Discontinued)
B77A		6MP Video Analytics Outdoor Hemispheric Dome with D/N, Adaptive IR, Extreme WDR, SLLS, Fixed lens
B78		12MP Outdoor Hemispheric Dome with D/N, Adaptive IR, Extreme WDR, SLLS, Fixed lens
I71		5MP Outdoor Hemispheric Dome with D/N, Advanced WDR, SLLS, Fixed lens
I73		6MP Outdoor Hemispheric Dome with D/N, Advanced WDR, ELLS, Fixed lens

## Package Contents

Check if the camera package comes with the following items.

<p>Camera</p> 	<p>Cable Gland</p> 	<p>Conduit Gland</p> 
<p>Hexagon Screwdriver</p> 	<p>Screw Plugs</p> 	<p>Screws for Surface Mount</p> 
<p>Terminal Block x 3</p>  <p><i>*may differ depending on model</i></p>	<p>Rag</p> 	<p>Warranty Card</p> <div data-bbox="1051 1249 1275 1346" style="border: 1px solid black; padding: 5px; text-align: center;"> <p>Warranty Card</p> </div>
<p>Quick Installation Guide</p> <div data-bbox="320 1559 544 1729" style="border: 1px solid black; padding: 10px; text-align: center;"> <p>Quick Installation Guide</p> </div>	<p>Drill Template</p> <div data-bbox="719 1581 873 1749" style="border: 1px solid black; padding: 10px; text-align: center;"> <p>Drill Template</p> </div>	

**IMPORTANT:** When the camera is taken out from the box, the lens cover is covered by a thin film. DO NOT remove this film. It is used to protect the lens from scratches or fingerprint marks which may happen during installation. Remove this film only after the camera is securely installed and all connections are complete.



## Physical Description

### I71, I72

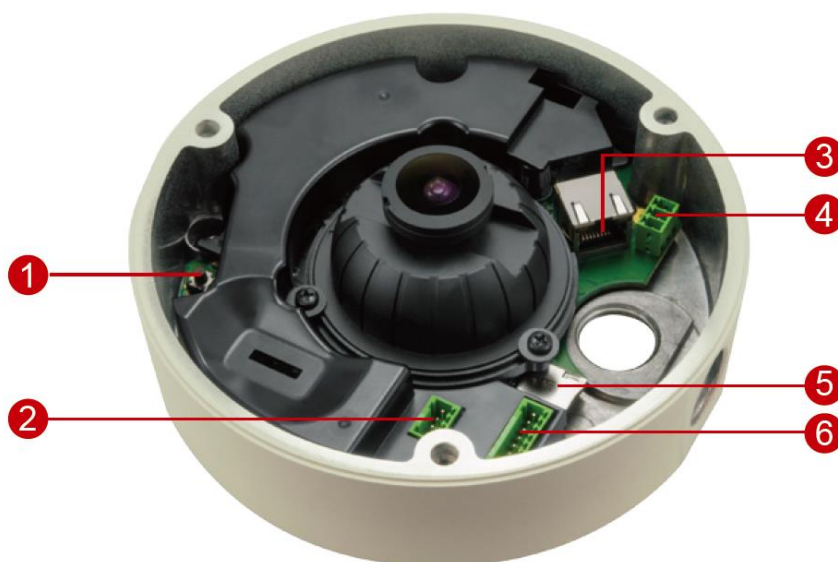

	Item	Description
1	Reset Button	Restores the factory default settings of the camera. To reset the camera, while the power is on, press and hold the Reset Button for at least 5 seconds or until the Power LED lights up.
2	Audio Input / Output	Connects to audio input and output devices, such as microphones and speakers. See <a href="#">Connecting Audio In / Out Devices (Optional)</a> on page 28.
3	Ethernet Port	Connects to a network using an Ethernet cable.
4	DC 12V Power Input	In case the camera is connected to a non-PoE (Power over Ethernet) switch, use this connector to connect the camera to an external power adapter. See <a href="#">Connecting a Power Adapter (Optional)</a> on page 26 for information.
5	Memory Card Slot	Insert a memory card (not included) into the slot for local recording purposes. See <a href="#">How to Install / Remove the Memory Card</a> on page 33. <b>NOTE:</b> Supports only microSDHC and microSDXC cards.
6	Digital Input / Output	Connects to digital input or output devices, such as an alarm trigger, panic button, etc. Digital Input (DI) and Digital Output (DO) devices are used in applications like motion detection, event triggering, alarm notifications, etc. See <a href="#">Connecting DI/DO Devices (Optional)</a> on page 28 for information.

## B74, B74A, B76, B76A, B77, B77A

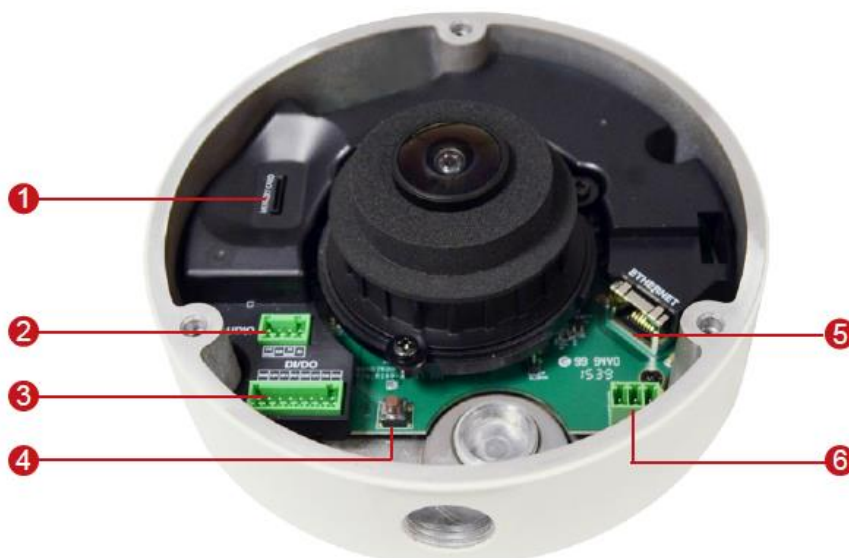

Item		Description
1	Memory Card Slot	Insert a memory card (not included) into the slot for local recording purposes. See <a href="#">How to Install / Remove the Memory Card</a> on page 33. <b>NOTE:</b> Supports only microSDHC and microSDXC cards.
2	Audio Input / Output	Connects to audio input and output devices, such as microphones and speakers. See <a href="#">Connecting Audio In / Out Devices (Optional)</a> on page 31.
3	Digital Input / Output	Connects to digital input or output devices, such as an alarm trigger, panic button, etc. Digital Input (DI) and Digital Output (DO) devices are used in applications like motion detection, event triggering, alarm notifications, etc. See <a href="#">Connecting DI/DO Devices (Optional)</a> on page 28 for information.
4	Reset Button	Restores the factory default settings of the camera. To reset the camera, while the power is on, press and hold the Reset Button for at least 5 seconds or until the Power LED lights up.
5	DC 12V Power Input	In case the camera is connected to a non-PoE (Power over Ethernet) switch, use this connector to connect the camera to an external power adapter. See <a href="#">Connecting a Power Adapter (Optional)</a> on page 26 for information.
6	Ethernet Port	Connects to a network using an Ethernet cable.

B78

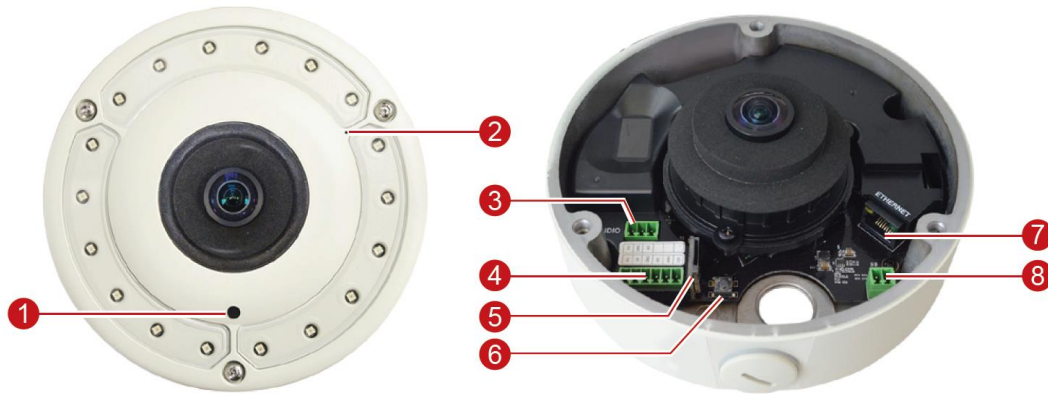

Item		Description
1	Light Sensor	Automatically detects ambient light.
2	Built-in Microphone	Receives audio input.
3	<ul style="list-style-type: none"> <li>• Video Output</li> <li>• Audio Output</li> </ul>	<ul style="list-style-type: none"> <li>• Connects to an analog video output device.</li> <li>• Connects to external audio output device, such as speakers. See <a href="#">Connecting Audio In / Out Devices (Optional)</a> on page 31.</li> </ul>
4	<ul style="list-style-type: none"> <li>• DC 5V Power Output</li> <li>• Digital Input / Output</li> <li>• DC 12V Power Input</li> </ul>	<ul style="list-style-type: none"> <li>• The DC 5V connector provides power input to digital output devices. If the power is insufficient, connect an external power source to power up the device.</li> <li>• Connects to digital input or output devices, such as an alarm trigger, panic button, etc. Digital Input (DI) and Digital Output (DO) devices are used in applications like motion detection, event triggering, alarm notifications, etc. See <a href="#">Connecting DI/DO Devices (Optional)</a> on page 28 for information.</li> <li>• In case the camera is connected to a non-PoE (Power over Ethernet) switch, use this connector to connect the camera to an external power adapter. See <a href="#">Connecting a Power Adapter (Optional)</a> on page 26 for information.</li> </ul>
5	Memory Card Slot	Insert a memory card (not included) into the slot for local recording purposes. See <a href="#">How to Install / Remove the Memory Card</a> on page 33. <b>NOTE:</b> Supports only microSDHC and microSDXC cards.

Item		Description
6	Reset Button	Restores the factory default settings of the camera. To reset the camera, while the power is on, press and hold the Reset Button for at least 5 seconds or until the Power LED lights up.
7	Ethernet Port	Connects to a network using an Ethernet cable.
8	Audio Input	Connects to an external active microphone. See <a href="#">Connecting Audio In / Out Devices (Optional)</a> on page 31.

## Mounting Solutions

There are several mounting options that you can use to install the camera. Select the most suitable solution for your installation environment.

Mount Types	Accessories
Surface Mount	Suitable when mounting the camera on flat and smooth surface, like ceilings or walls. This solution directly installs the camera to the surface without additional accessories. See <a href="#">Installing the Camera on a Surface</a> on page 14 for more information.
Tilted Wall Mount	Suitable when mounting the camera on high walls. The camera can be tilted 10° to capture a larger viewing angle below the camera and less on the ceiling.
Pendant Mount	Suitable when mounting the camera on hard and high ceilings.
Horizontal Pole Mount	Suitable when mounting the camera on a horizontal pole.
Vertical Pole Mount	Suitable when mounting the camera on a vertical pole.
Corner Mount	Suitable when mounting the camera on a corner area. The camera can also be tilted 10° to capture a larger viewing angle below the camera and less above.

### NOTE:

- For more information about the mounting solutions and accessories, please check the online [Mounting Accessory Selector](http://www.acti.com/mountingselector) (<http://www.acti.com/mountingselector>).
- The mounting accessories are not included in the package. Contact your sales agents to purchase.

# Installing the Camera on a Surface

This section describes the procedures in directly mounting the camera on a flat surface, such as a hard or dropped ceiling and straight or tilted walls.

The installation procedures of other mounting solutions are covered in the Installation Guide downloadable from the website (<http://www.acti.com/mountingselector>).

## NOTE:

- The following camera images are taken using the closest camera model; therefore some images and components may vary from the actual camera.
- Before installation, make sure the wall or the ceiling can bear more than the weight of the camera.

## Step 1: Drill the Holes

Before drilling the holes on the ceiling or wall, note the direction of the connectors side of the camera, which is also the opposite side of the camera logo. This influences the camera placement and where you should drill the hole where the cables will pass through or how the cables will go along the ceiling or wall.

1. Attach the supplied drill template on the surface according to the preferred camera orientation.
2. Determine how the cables will be routed: ***pass through the surface*** or ***along the surface***.
  - ***If the cables will pass through the surface***, drill the cable hole and the three (3) screw holes on the surface.

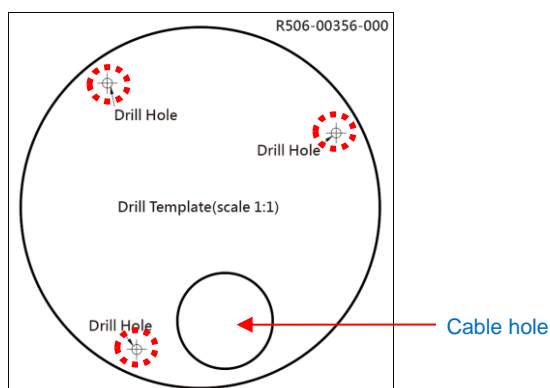

- ***If the cables will be routed along the surface***, just drill the three (3) screw holes on the surface.

3. Detach the drill template from the surface and insert the plastic plugs into the screw holes.
  - a. Drill the cable hole and the three (3) screw holes on the surface.
  - b. Remove the cap covering the bottom hole of the camera, and attach the cap to the side hole to close it. The network cable will pass through the surface and the bottom hole to the camera.
- ***If the cables will be routed along the surface***, skip to the next step.

## Step 2: Open the Camera Cover

NOTE: To avoid scratches or leaving fingerprints on the dome cover, it is recommended to retain the plastic covering the dome cover until the camera is completely installed. However, the plastic has been removed on some of the pictures in this documentation to show clarity of the procedures being described.

1. **If the cables will pass through the surface**, remove the cap covering the bottom hole of the camera, and attach the cap to the side hole to close it. The network cable will pass through the surface and the bottom hole to the camera.



2. With the bundled hex screwdriver, loosen the three (3) screws securing the dome cover.



3. Carefully lift to open the cover and place it on the side of the camera.



**NOTE:** Do not abruptly lift the cover; a cable is connected on the camera body and the cover.



4. If necessary, insert a memory card, with the metallic contacts facing down, into the card slot of the camera. See [How to Insert the Memory Card](#) on page 33.

## Step 3: Prepare to Waterproof and Connect the Cable

The camera comes with two (2) glands used for waterproof installation:

- **Cable Gland:** For use with an **Exterior-grade Ethernet cable**. Exterior-grade Ethernet cables are already waterproof. See [Waterproof Solution with Naked Cable](#) on page 19.
- **Conduit Gland:** For use with a flexible conduit. This solution is recommended when an exterior-grade Ethernet cable is not available or other cables, such as power adapter, DI/DO devices, etc. will be connected with the camera. See [Waterproof Solution with Conduit](#) on page 21.

Determine the type of waterproof solution that is applicable to your installation requirements and prepare the necessary accessories or purchase extra materials.

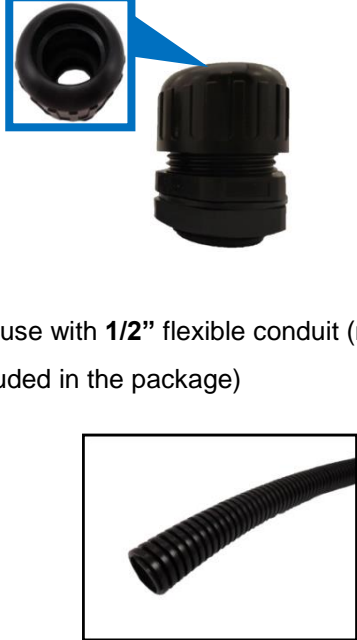
Cable Gland	Conduit Gland
 <p>For use with an <b>Exterior-grade Ethernet cable</b> (not included in the package).</p>	 <p>For use with <b>1/2"</b> flexible conduit (not included in the package)</p>

### Waterproof Solution with Naked Cable

This section describes the procedures to waterproof the cabling connections using an exterior-grade Ethernet cable.

1. Disassemble the cable gland as shown below:



2. Insert the clamping nut into the Ethernet cable.



3. Insert the sealing insert with claw.

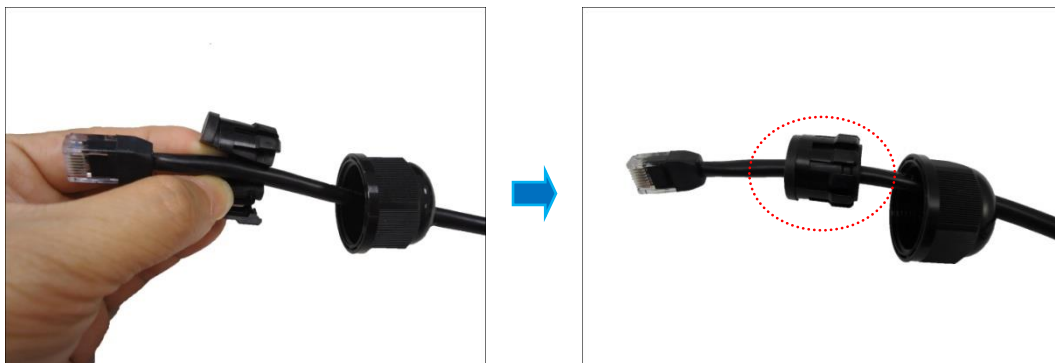

- Attach the cable gland body to the hole of the camera.



Attach to Camera Side Hole

or



Attach to Camera Bottom Hole

**NOTE:** The following images are taken using the side hole of the camera; the same procedures apply when using the bottom side hole.

- If the cable will be routed along the surface**, mount the camera to the surface first before doing the following cabling procedures. See [Step 4: Install the Camera to the Surface](#) on page 24.
- Insert the Ethernet cable through the cable gland body and connect it to the Ethernet port of the camera.

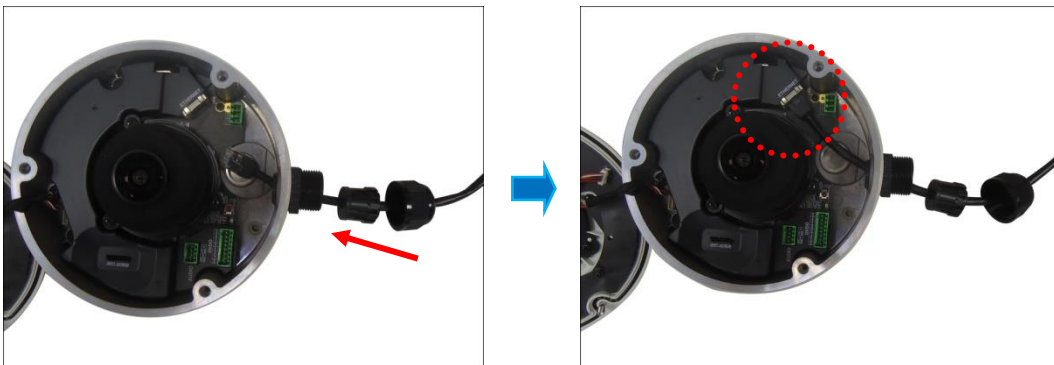

- Insert the claw and rubber insert into the cable gland body and then attach the clamping nut to complete the cable solution.

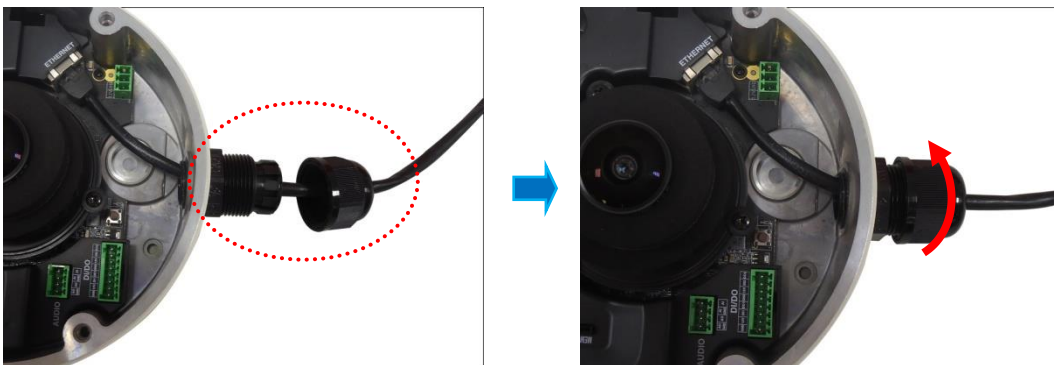

**NOTE:** Make sure the clamping nut is tightly attached to the cable gland body.

- Proceed with [Step 4: Install the Camera to the Surface](#) on page 24.

### Waterproof Solution with Conduit

This section describes the procedures to waterproof the cabling connections using a flexible conduit with 1/2" trade size (not supplied). This is the recommended solution when connecting an external power adapter, audio in/out, or digital input/output (DI/DO) devices to the camera.

- Disassemble the cable gland as shown below:

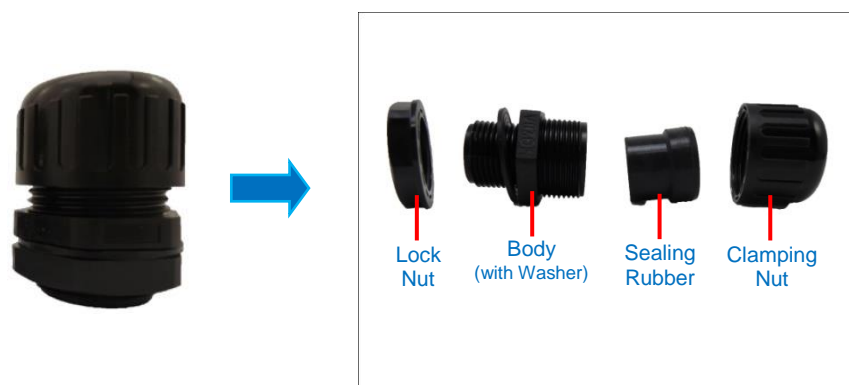

**NOTE:** In this installation, the conduit gland body can be securely attached to the camera, therefore the use of lock nut is not necessary. Please set the lock nut aside.

- Pull the Ethernet cable and other cables (if any) through the flex conduit.



**NOTE:** To connect an external power adapter, audio in/out, or digital input/output (DI/DO) devices, insert the cables without connectors through the flex conduit together with the Ethernet cable at this point.

3. Insert the clamping nut through the flex conduit.



4. Insert the sealing rubber and attach it at the end of the flex conduit.

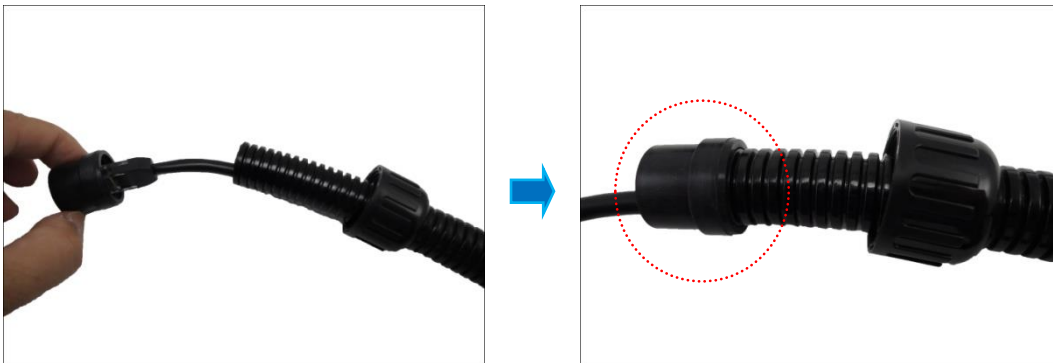

5. Attach the conduit gland body to the hole of the camera.



Attach to Camera Side Hole

Attach to Camera Bottom Hole

**NOTE:** The following images are taken using the side hole of the camera; the same procedures apply when using the bottom side hole.

6. ***If the cables will be routed along the surface***, mount the camera to the surface first before doing the succeeding cabling procedures. See [Step 4: Install the Camera to the Surface](#) on page 24.

7. Insert the Ethernet cable and other cables (if any) through the conduit gland body.

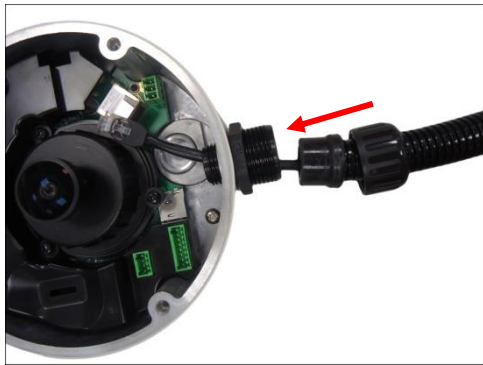

Ethernet Cable Only

or

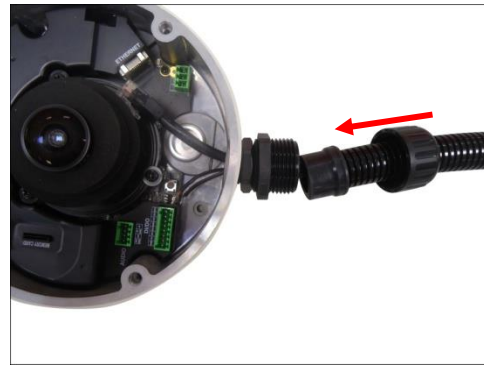

Ethernet and External Power Adapter Cable

8. Connect the Ethernet cable to the Ethernet port of the camera. If connecting other cables, such as an external power adapter, audio in/out or DI/DO devices, connect the terminal blocks at this point and connect them to the corresponding connectors of the camera (see [Other Connections](#) on page 26 for more information).



or

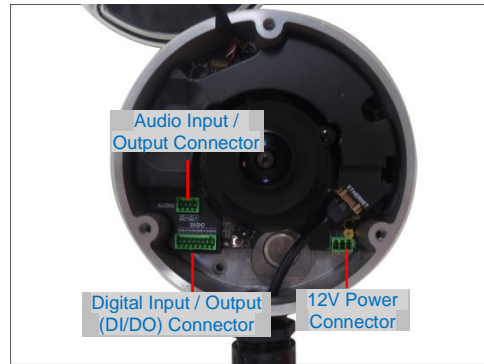

9. Insert the sealing rubber into the conduit gland body and attach the clamping nut to complete the cable solution.



→



**NOTE:** Make sure the clamping nut is tightly attached to the conduit gland body.

10. Proceed with see [Step 4: Install the Camera to the Surface](#) on page 24.

## Step 4: Install the Camera to the Surface

Attach the camera to the surface using the three (3) supplied screws. It is recommended to install the camera to the surface with the cable hole facing down to avoid water leak concerns.



**NOTE:** Make sure the camera screws have rubber rings. If the screws you received do not have rubber rings, please contact your local sales agents or our [Customer Help Desk \(CHD\)](#) for support.

**⚠ CAUTION:** *When using electric screwdrivers*, be careful not to touch the internal camera components while attaching the screws. Since electric screwdrivers vary in sizes, speed, and force, they may bruise and damage the internal camera components.

**DISCLAIMER:** ACTi will not be responsible for camera damage caused by improper installations or the misuse of equipment for installation.

## Step 5: Connect Camera to Network

Connect the other end of the network cable to a switch or injector. Then, connect the switch or injector to a network or PC and a power source. See Power-over-Ethernet (PoE) example connection diagram below.

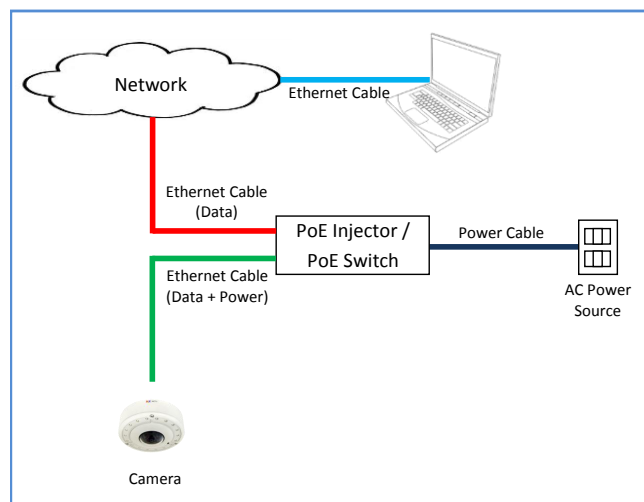



In case of using a non-PoE switch, power up the camera using a power adapter (not supplied)  
As needed, power up the other connected devices.

## Step 6: Access the Camera Live View

---

See [Accessing the Camera](#) on page 36 for more information.

Based on the live view, adjust the viewing angle orientation as needed. See [How to Rotate the Viewing Orientation](#) on page 32.

## Step 7: Close the Cover

---

Tighten the three (3) screws to secure the cover.



## Other Connections

This section describes the procedures in preparing the external devices that you can connect to the camera. The camera supports DC12V power input, Digital Input and Output (DI/DO) and Audio Input and Output devices using the bundled terminal blocks. The use of these devices, however, is optional.

### Connecting a Power Adapter (Optional)

In case of using a non-PoE switch or your PoE switch has limited power supply, you can purchase a power adapter and directly connect the camera to a power outlet. The power adapter must be connected to the supplied terminal block before use. Check the camera package for the appropriate terminal block. The pictures below are for reference only, actual items may vary depending on purchased model.

To do this, follow the procedures below:

1. Loosen the screws of the **12V** and **GND** pins of the power terminal block.



2. Take note that a standard power adapter cable has two (2) different wires:

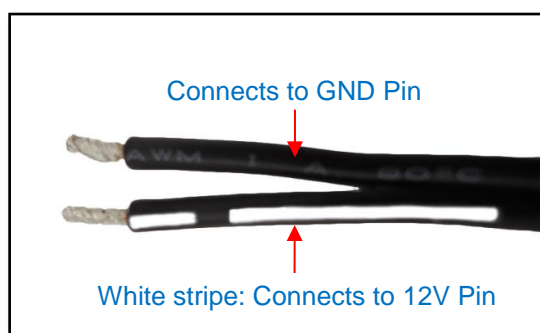

3. Connect the wire with the white stripe to the **12V** pin and the other to the **GND** pin.

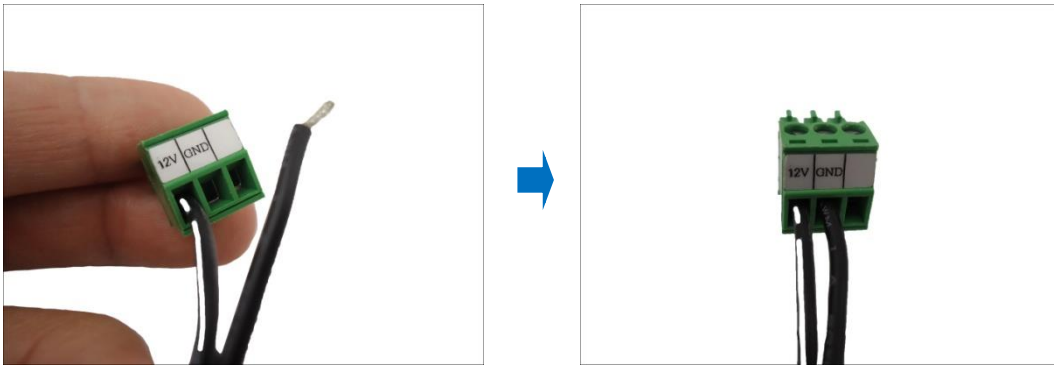

4. Tighten the screws of the **12V** pin and the **GND** pins to secure the wire connection.



5. Set the prepared power adapter for connection later. Below is an example of a power adapter with an attached terminal block.



**NOTE:** The power adapter is not bundled in the package.

## Connecting DI/DO Devices (Optional)

Depending on your surveillance needs, you may connect digital input or output devices to your camera to trigger events or notifications.

Digital Input (DI) devices can be used to notify the camera about an activity in the camera site. DI can be triggers of events. For example, you can connect a “panic button” to the camera; as such when the panic button is pressed, the alarm signal will be sent through the camera. Other common DI device applications are emergency button, smoke detector, passive infrared sensor, etc.

Digital Output (DO) devices are external devices that are activated by the camera upon an event inside the camera. For example, you can connect an “alarm horn” to the camera; as such when an event occurs inside the camera (e.g. detected intruder), the alarm horn will sound. Other common DO device applications are motion-triggered lights, electric fence, magnetic door locks, etc.

The supported number of digital input / output varies depending on camera model. For some models, you can connect up to two DI and two DO devices to your camera.

Press and hold the orange tab as you insert the wire through the pin slot, then release the orange tab to secure the wire.

To connect input devices (DI), map the pins to one of the pin combinations below:

Device	Pin	Mapping Instructions
Digital Input 1 (DI1)	GND	Connect the wires of the first input device to <b>GND</b> and <b>DI1</b> .
	DI1	
Digital Input 2 (DI2)	GND	Connect the wires of the second input device to <b>GND</b> and <b>DI2</b> .
	DI2	

To connect output devices (DO), map the pins to one of the pin combinations below:

Device	Pin	Mapping Instructions
Digital Output 1 (DO1)	12V	Connect the wires of the first output device to <b>12V</b> and <b>DO1</b> .
	DO1	
Digital Output 2 (DO2)	12V	Connect the wires of the second output device to <b>12V</b> and <b>DO2</b> .
	DO2	

The table below shows the DI/DO connection specifications:

Device			
DI	Connection design		TTL - compatible logic levels
	Voltage	To trigger (low)	Logic level 0: 0V ~ 0.4V
		Normal (high)	Logic level 1: 3.1V ~ 30V
	Current		10mA ~ 100mA
DO	Connection design		Transistor (Open Collector)
	Voltage & Current		< 24V DC, < 50mA

### Typical Connection

Based on these specifications, if the DI device has a voltage of 0V ~ 30V or the DO device has a voltage of < 24V (<50mA), then the camera can supply internal power to these devices and there is no need to connect the DI/DO device to an external power source.

In this case, wire connection to **GND** and **DI1** pins to connect a DI device and use the **12V** and **DO1** pins to connect a DO device. See wiring scheme below:

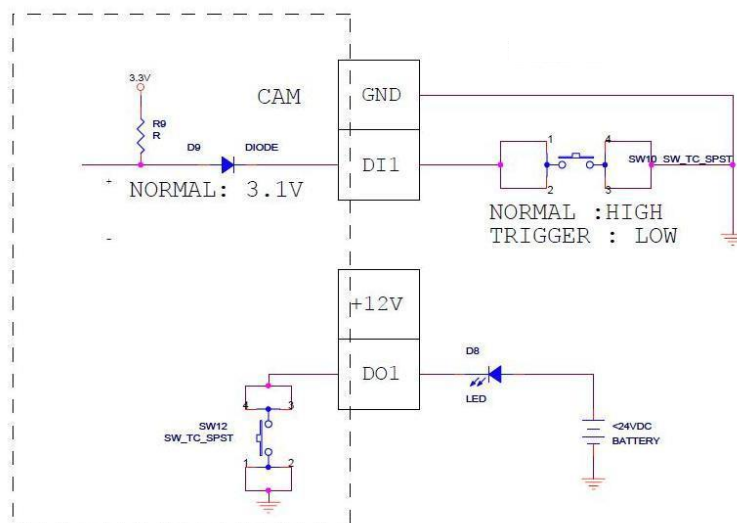

Consequently, wire the connection to **GND** and **DI2** to connect a second DI or to **12V** and **DO2** to connect a second DO device.

### High Voltage DO Device Connection

Even though the camera provides 12V power, this may not be enough for some high voltage DO devices, such as a ceiling light or a motor that opens or closes a gate. In this case, there is a need to connect an external relay. See wiring scheme below:

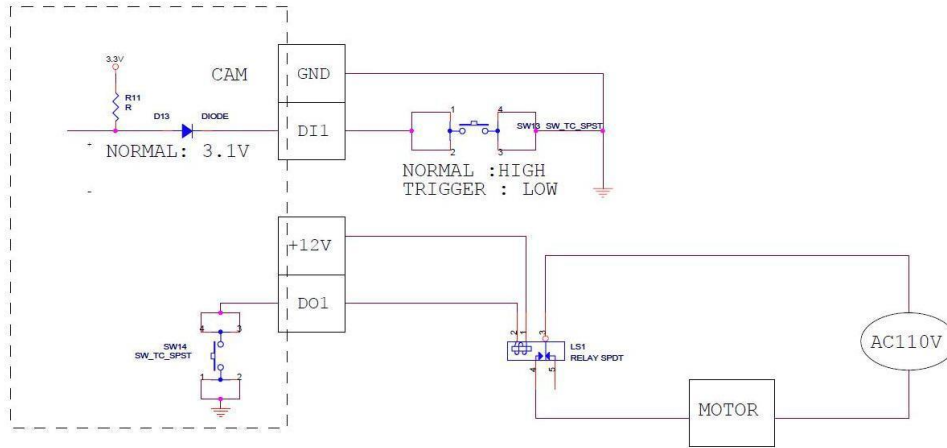

Note that when choosing an appropriate relay, please refer to its specifications and make sure they match the above design. The triggering circuit voltage has to be around 12V DC and the switch-controlled circuit voltage has to match the external power supply (e.g. 110V AC or 220V AC).

The illustration below is a graphic example of connecting a relay to a high voltage DO device.

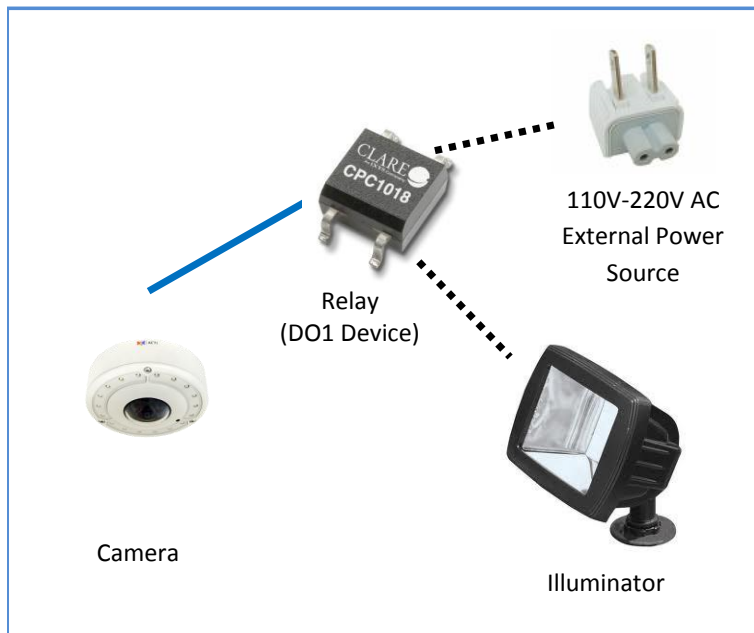

**NOTE:** For more information on DI/DO connections, please refer to the Knowledge Base article [All About Digital Input and Digital Output](http://Download.acti.com?id=516) downloadable from the link below (<http://Download.acti.com?id=516>).

## Connecting Audio In / Out Devices (Optional)

Depending on your surveillance needs, you may connect audio input or output device, such as an active microphone or speaker, to your camera. In this case, you need to connect the audio input/output device to the supplied audio terminal block.

To connect audio input / output devices, map the pins to one of the pin combinations below:

Device	Pin	Mapping Instructions
Audio Output	GND	Connect the wires of the audio output device to <b>GND</b> and <b>AUDIO.OUT</b> .
	AUDIO.OUT	
Audio Input	GND	Connect the wires of the audio input device to <b>GND</b> and <b>AUDIO.IN</b> .
	AUDIO.IN	

Press and hold the orange tab as you insert the wire through the pin slot, then release the orange tab to secure the wire.

**NOTE:** For more information about AUDIO in connections, please refer to the Knowledge Base article [How to Use Audio-in of ACTi Cameras](#), downloadable from the link below (<http://Download.acti.com?id=534>).

# Other Adjustments and Accessories

## How to Rotate the Viewing Orientation

The viewing orientation of the camera is indicated by the arrow as shown below.



To change the orientation, do the following steps:

1. Slightly loosen the three (3) screws securing the lens module.

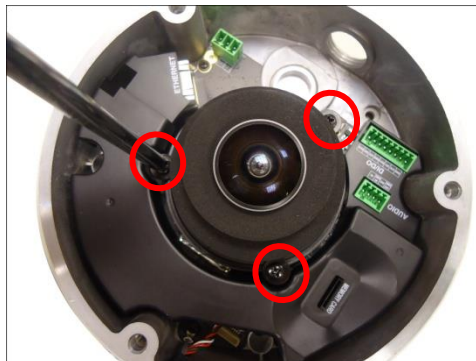

2. Turn the lens module according to the preferred orientation.



3. Tighten the three (3) screws to fix its position.



## How to Install / Remove the Memory Card

---

The camera supports local video recording to a memory card (not supplied).

**NOTE:** Camera supports microSDHC and microSDXC cards.

### How to Insert the Memory Card

1. Open the dome cover.
2. Insert the memory card with the metal contacts facing toward the side which has Memory Card sign.



3. Push the card into place.

Once inserted, make sure to access the camera Web Configurator and “mount” the card to prepare the card for local recording. Refer to the camera Firmware User’s Manual for more information.

### How to Remove the Memory Card

In case there is a need to remove the card, make sure to access the camera Web Configurator to safely “unmount” the card first (see the camera Firmware User’s Manual for more information). Once unmounted from the firmware, pull the card out from the slot.

## How to Replace the Dome Cover

For more discreet surveillance needs, the bundled dome cover can be replaced with a smoked, vandal proof cover available for purchase. To replace the dome cover, do the following:

1. Open the dome cover.
2. Remove the four (4) screws securing the dome cover bracket.

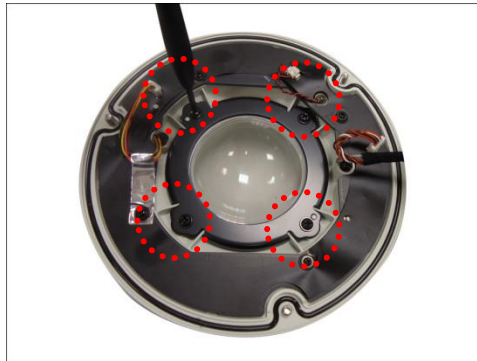

3. Remove the bracket and the dome cover from the cover housing.

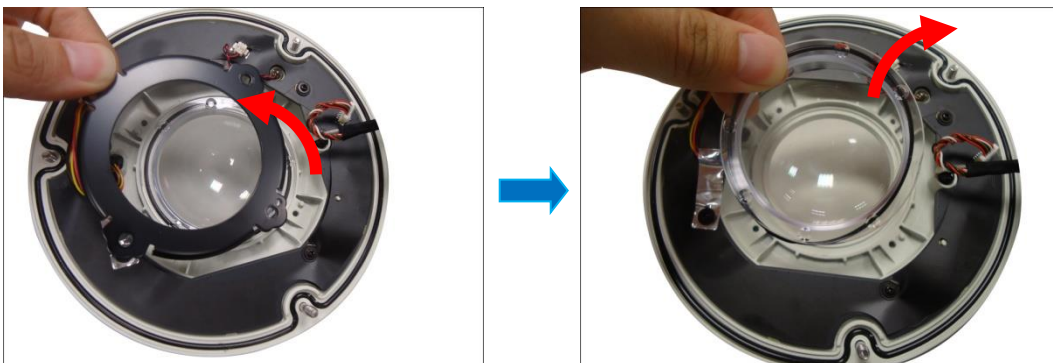

4. Remove the rubber from the dome cover.



- Align and place the rubber on the dome cover housing and then install the replacement dome cover.

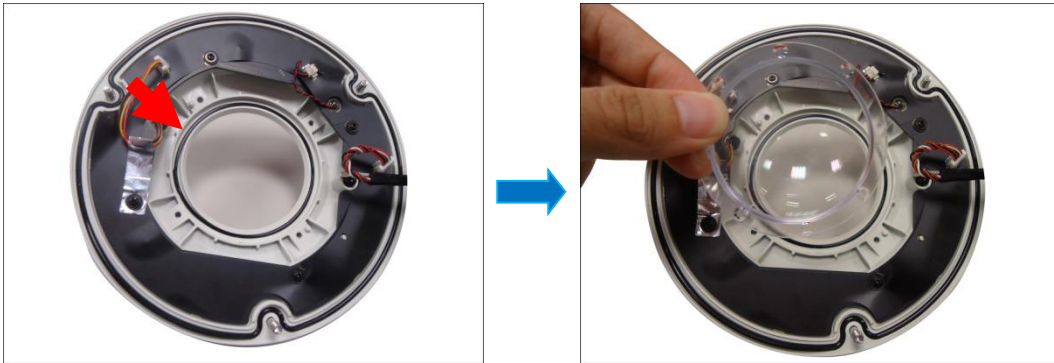

- Align the bracket to the cover housing.

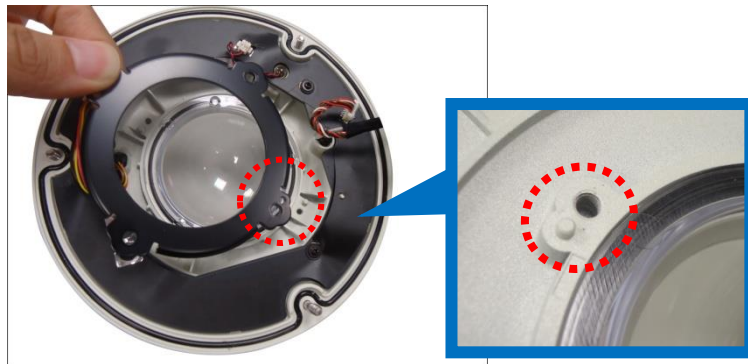

- Attach the four (4) to secure the bracket to the cover housing.

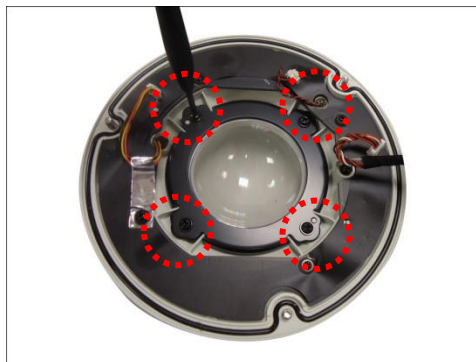

**IMPORTANT:** Make sure to replace the dome cover securely and accordingly.

# Accessing the Camera

## Configure the IP Addresses

In order to be able to communicate with the camera from your PC, both the camera and the PC have to be within the same network segment. In most cases, it means that they both should have very similar IP addresses, where only the last number of the IP address is different from each other. There are 2 different approaches to IP Address management in Local Area Networks – by DHCP Server or Manually.

### Using DHCP server to assign IP addresses

If you have connected the computer and the camera into the network that has a DHCP server running, then you do not need to configure the IP addresses at all – both the camera and the PC would request a unique IP address from the DHCP server automatically. In such case, the camera will immediately be ready for the access from the PC. The user, however, might not know the IP address of the camera yet. It is necessary to know the IP address of the camera in order to access it using a Web browser.

**The quickest way to discover the cameras in the network** is to use the simplest network search, built in the Windows system – just by pressing the “Network” icon, all the cameras of the local area network will be discovered by Windows, thanks to the UPnP function support of our cameras.

In the example below, the camera that has just been connected to the network is successfully found.

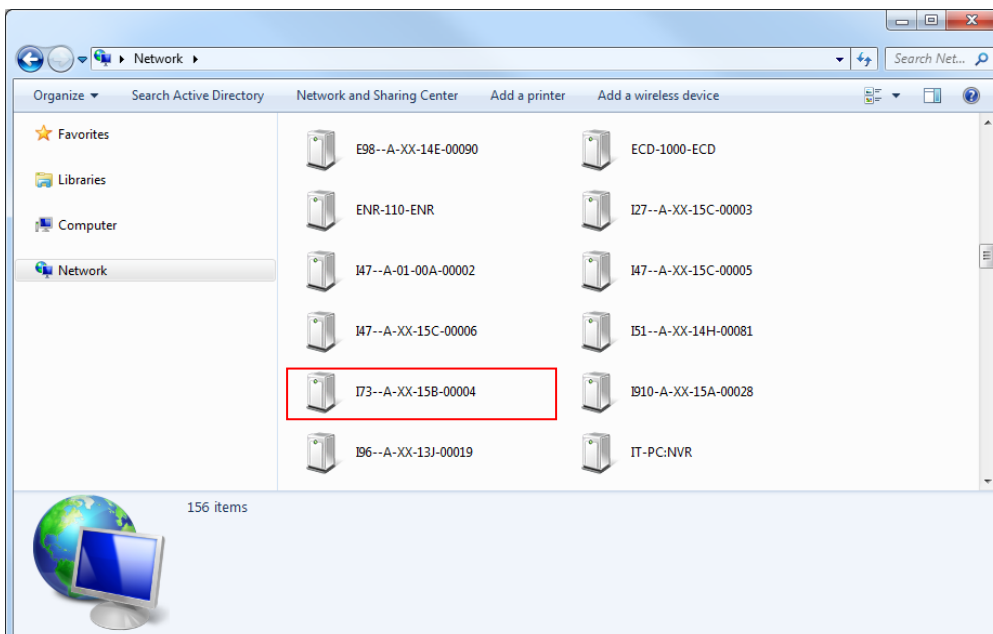

Double-click the mouse on the camera model name, the default browser of the PC is automatically launched and the IP address of the target camera is already filled in the address bar of the browser.

If you work with our cameras regularly, then **there is even a better way to discover the cameras in the network** – by using **IP Utility**. The IP Utility is a light software tool that can not only discover the cameras, but also list lots of valuable information, such as IP and MAC addresses, serial numbers, firmware versions, etc, and allows quick configuration of multiple devices at the same time.

Search and download IP Utility for free from <http://www.acti.com/DownloadCenter>.

When you launch IP Utility, the list of connected cameras in the network will be shown. See sample illustration below:

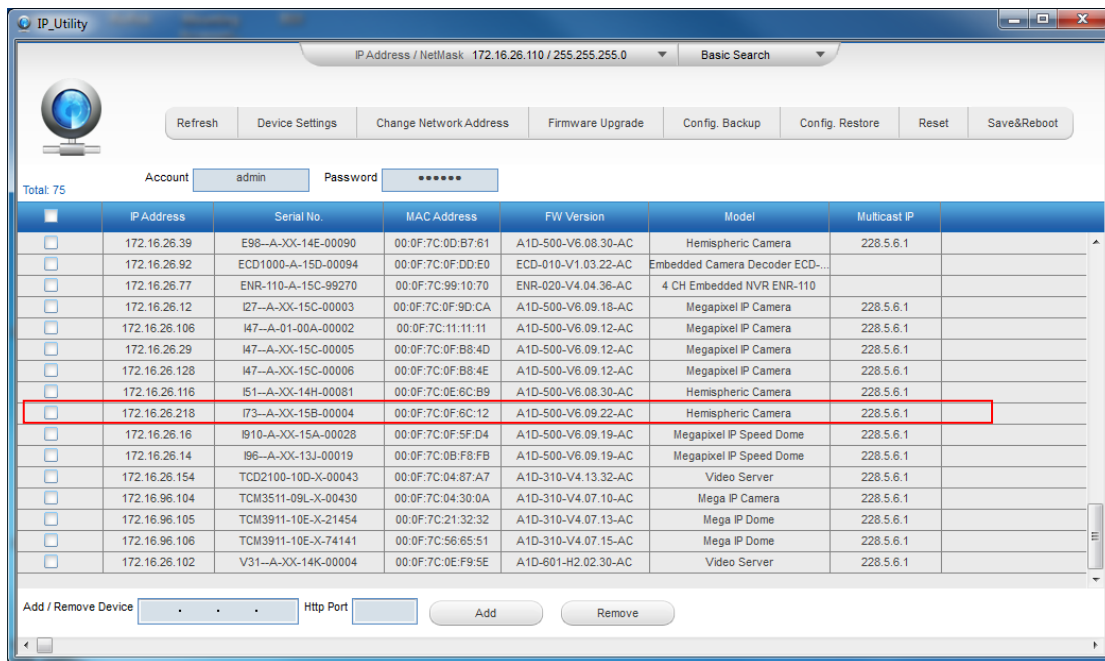

You can quickly notice the camera model in the list. Click on the IP address to automatically launch the default browser of the PC with the IP address of the target camera already filled in the address bar of the browser.

## Use the default IP address of the camera

If there is no DHCP server in the given network, the user may have to manually assign the IP addresses to both the PC and the camera to make sure they are in the same network segment.

When the camera is plugged into the network and it does not detect any DHCP services, it will automatically assign itself a default IP:

**192.168.0.100**

Whereas the default port number would be **80**. In order to access that camera, the IP address of the PC has to be configured to match the network segment of the camera.

## Manually adjust the IP address of the PC

In the following example, based on Windows 7, we will configure the IP address to **192.168.0.99** and set Subnet Mask to **255.255.255.0** by using the steps below:

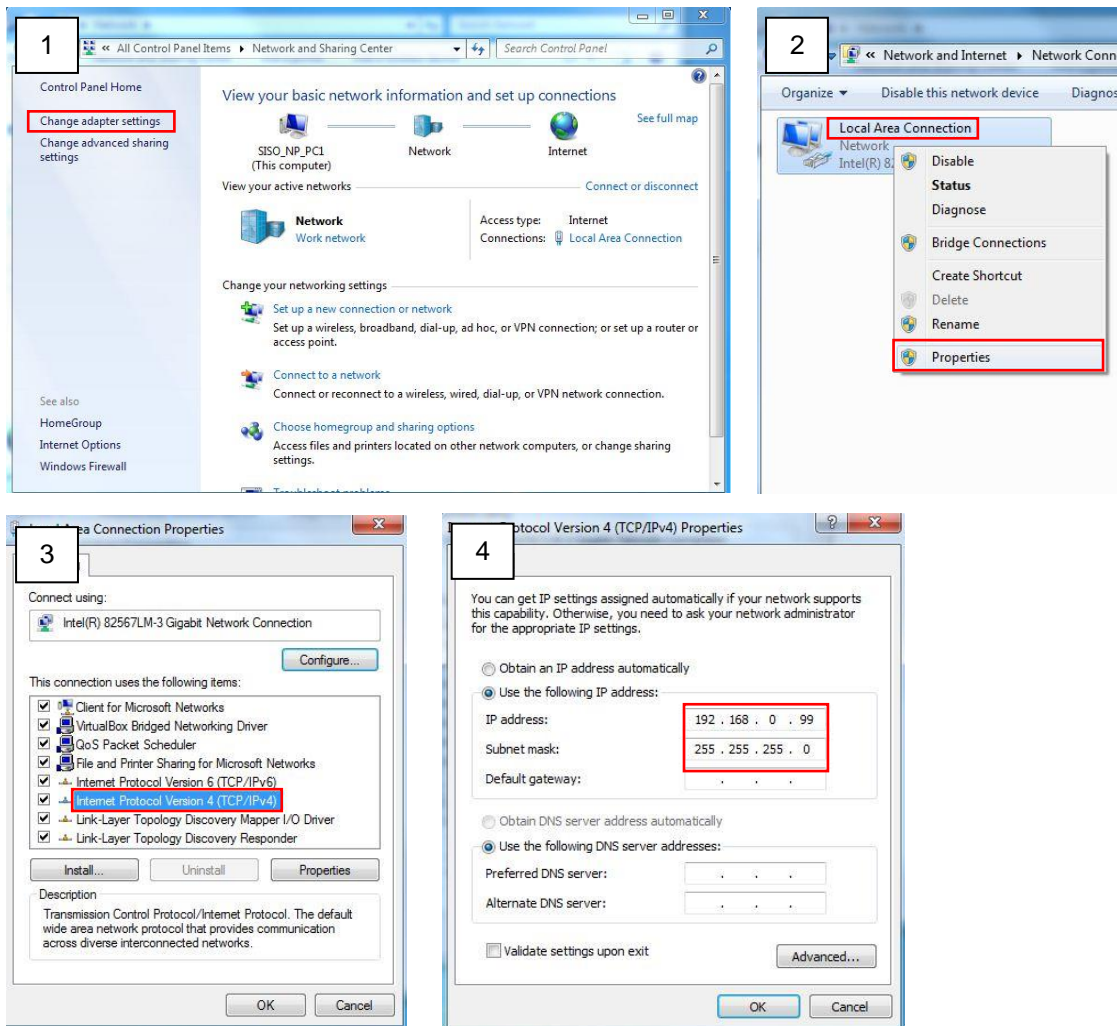

**Manually adjust the IP addresses of multiple cameras**

If there are more than one camera to be used in the same local area network and there is no DHCP server to assign unique IP addresses to each of them, all of the cameras would then have the initial IP address of **192.168.0.100**, which is not a proper situation for network devices – all the IP addresses have to be different from each other. The easiest way to assign cameras the IP addresses is by using **IP Utility**:

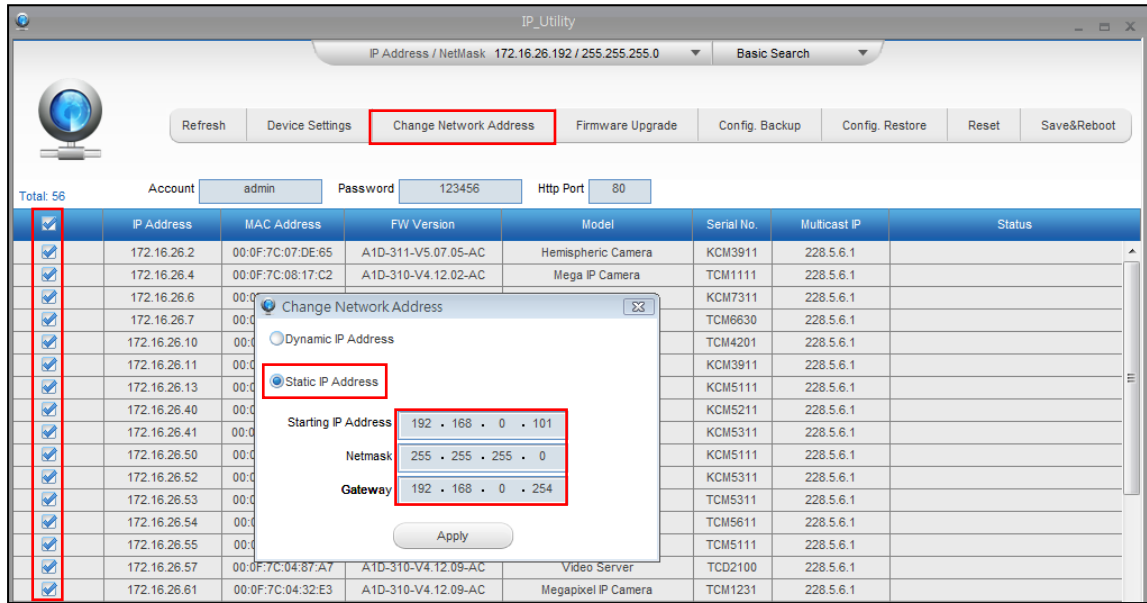

With the procedure shown above, all the cameras will have unique IP addresses, starting from 192.168.0.101. In case there are 20 cameras selected, the last one of the cameras would have the IP 192.168.0.120.

Later, by pressing the “Refresh” button of the IP Utility, you will be able to see the list of cameras with their new IP addresses.



Please note that it is also possible to change the IP addresses manually by using the Web browser. In such case, please plug in only one camera at a time, and change its IP address by using the Web browser before plugging in the next one. This way, the Web browser will not be confused about two devices having the same IP address at the same time.

## Access the Camera

Now that the camera and the PC are both having their unique IP addresses and are under the same network segment, it is possible to use the Web browser of the PC to access the camera.

You can use **Microsoft Internet Explorer** to access the camera

Functionality	Internet Explorer
Live Video	Yes
Live Video Area Resizable	Yes
PTZ Control	Yes
Capture the snapshot	Yes
Video overlay based configuration (Motion Detection regions, Privacy Mask regions)	Yes
All the other configurations	Yes

When using Internet Explorer browser, the ActiveX control for video stream management will be downloaded from the camera directly – the user just has to accept the use of such control when prompted so. No other third party utilities are required to be installed in such case.

**The examples in this manual are based on Internet Explorer browser in order to cover all functions of the camera.**

Assuming that the camera's IP address is **192.168.0.100**, you can access it by opening the Web browser and typing the following address into Web browser's address bar:

**<http://192.168.0.100>**



Upon successful connection to the camera, the user interface called **Web Configurator** would appear together with the login page. The HTTP port number was not added behind the IP address since the default HTTP port of the camera is 80, which can be omitted from the address for convenience.

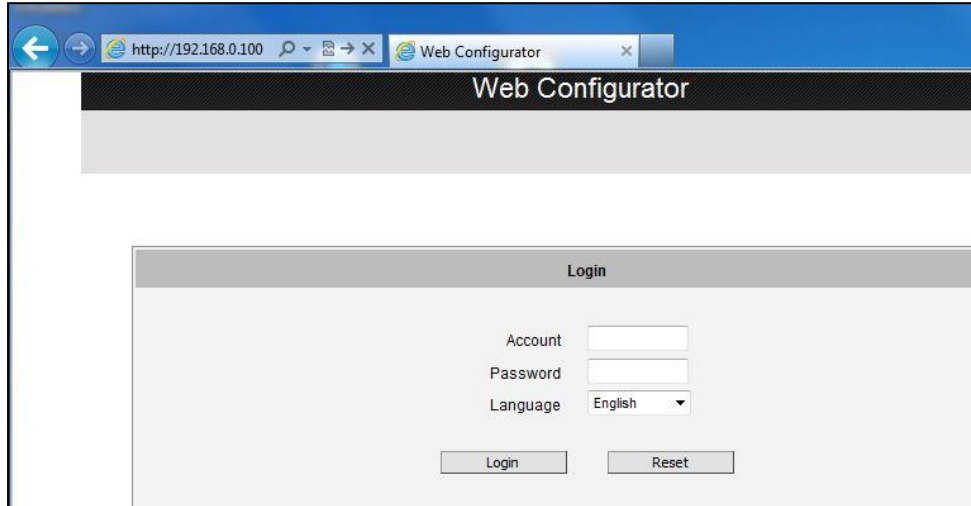

Before logging in, you need to know the factory default Account and Password of the camera.

Account: **Admin**

Password: **123456**

For further operations, please refer to the **Firmware User Manual**.



Copyright © 2017, ACTi Corporation All Rights Reserved

7F, No. 1, Alley 20, Lane 407, Sec. 2, Ti-Ding Blvd., Neihu District, Taipei, Taiwan 114, R.O.C.

TEL : +886-2-2656-2588    FAX : +886-2-2656-2599

Email: [sales@acti.com](mailto:sales@acti.com)