

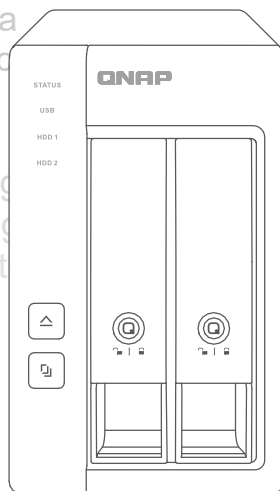

TR-002

Quick Installation Guide

快速安裝手冊 빠른 설치 설명서 Guía de Instalación Rápida
クイックインストールガイド Hızlı Kurulum Kılavuzu
คู่มือการติดตั้งแบบเร็ว Gyors telepítési útmutató
Instrukcja szybkiej instalacji Průvodce rychlou in
Kurzininstallationsanleitung 快速安裝指南
Guida di installazione rapida
Краткое руководство по установке
Snabbinstallationsguide
Guia de Instalação Rápida
Hurtiginstallasjonsveiledning
Hurtig installationsvejledning
Pika-asennusopas Installat
Snelle Installatiegids



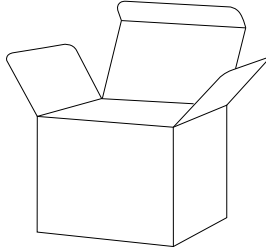

SSD/HDD

<https://www.qnap.com/compatibility>

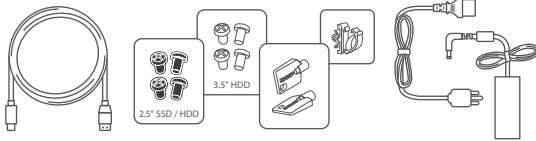
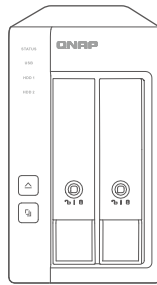

- All the drive data will be cleared upon SSD / HDD initialization ----- en
- Alle Laufwerksdaten werden bei SSD/HDD-Initialisierung gelöscht ----- de
- Toutes les données présentes sur les disques seront effacées lors de l'initialisation des SSD/HDD ----- fr
- Tutti i dati presenti verranno cancellati durante l'inizializzazione degli SSD / HDD ----- it
- Todos los datos del disco serán borrados con la inicialización del SSD / HDD ----- es
- Alle gegevens worden gewist tijdens de initialisatie van de SSD / HDD's ----- nl
- All data kommer att raderas när SSD / HDD initieras ----- sv
- SSD / HDD alustaminen poistaa kaikki tiedostot ----- fi
- Alle data på drevet vil blive ryddet efter initialisering af SSD / HDD ----- da
- All data vil bli slettet når SSD / HDD er initialisert ----- no
- Todos os dados do SSD / HDD serão apagados com a inicialização do SSD / HDD ----- pt
- После инициализации SSD/HDD все данные на нем будут удалены ----- ru
- 硬碟初始化時，所有資料皆會被清除 ----- tw
- 所有 SSD / HDD 上的数据都将会被清除 ----- cn
- SSD/HDD を初期化すると、すべてのデータが消去されます ----- ja
- SSD / HDD 를 초기화 시키면 드라이브의 모든 데이터가 손실됩니다 ----- ko
- ข้อมูลในไดรฟ์จะถูกลบออก เมื่อมีการตั้งค่าเริ่มต้น ----- th
- Kurulum başlangıcında SSD / HDD disk üzerinde ki tüm veri silinecektir ----- tr
- Minden korábbi adat törlődik az SSD / HDD-ről az első rendszerindítás során ----- hu
- Všetchna data na SSD / HDD budou smazána v důsledku inicializace ----- cs
- Podczas instalacji wszystkie dane na dyskach SSD / HDD zostaną usunięte ----- pl
- يتم مسح كل بيانات محرك الأقراص عند تهيئة HDD (قرص الحالة الصلبة) / SSD (محرك الأقراص الصلبة) ----- ar

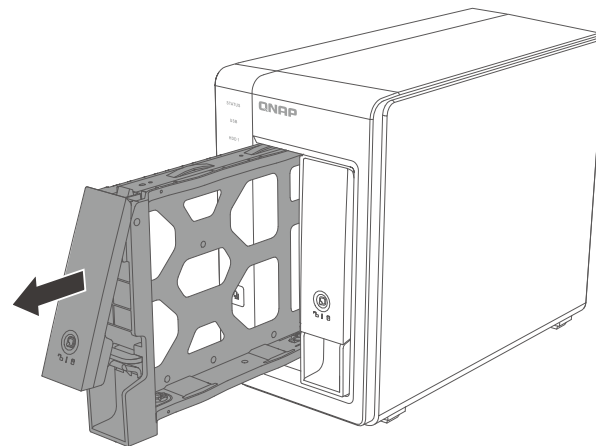
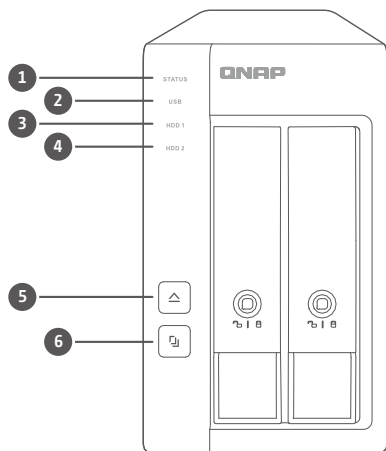

- 1 Status LED
- 2 USB LED
- 3 HDD1 LED
- 4 HDD2 LED
- 5 Eject button
- 6 USB One Touch Copy button (QTS only)

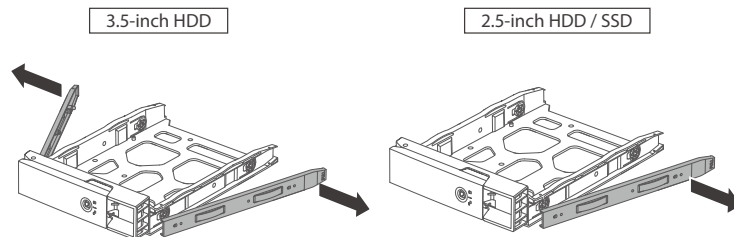

3.5-inch HDD

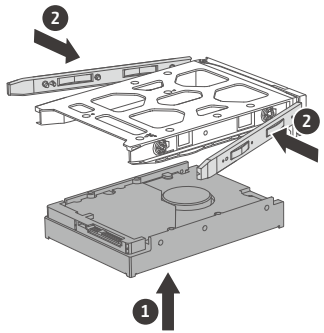

2.5-inch HDD / SSD

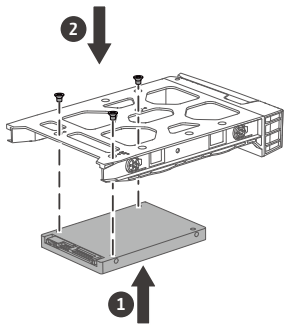

Optional

• 3.5-inch HDD

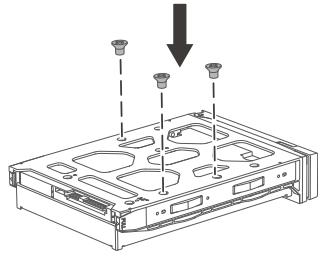

• USB Cable Lock

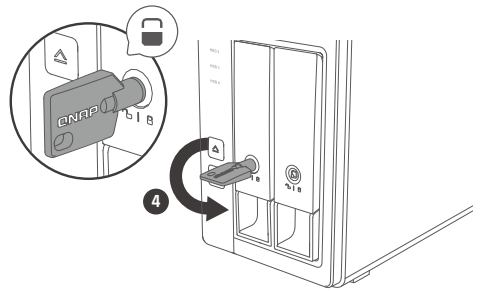
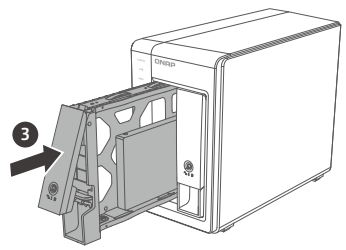
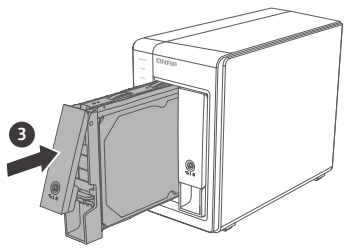
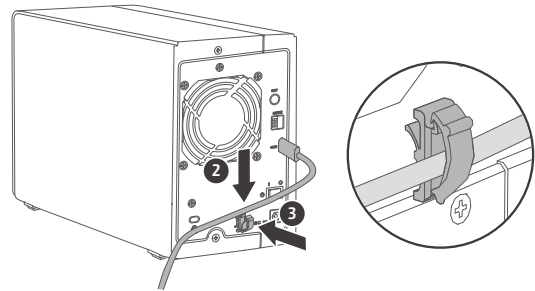
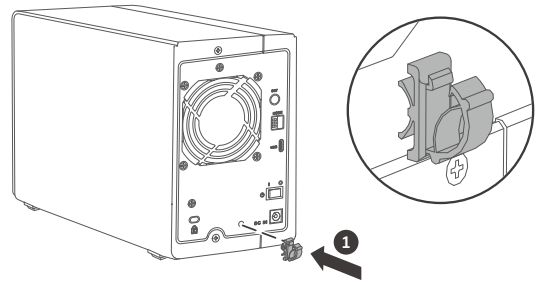

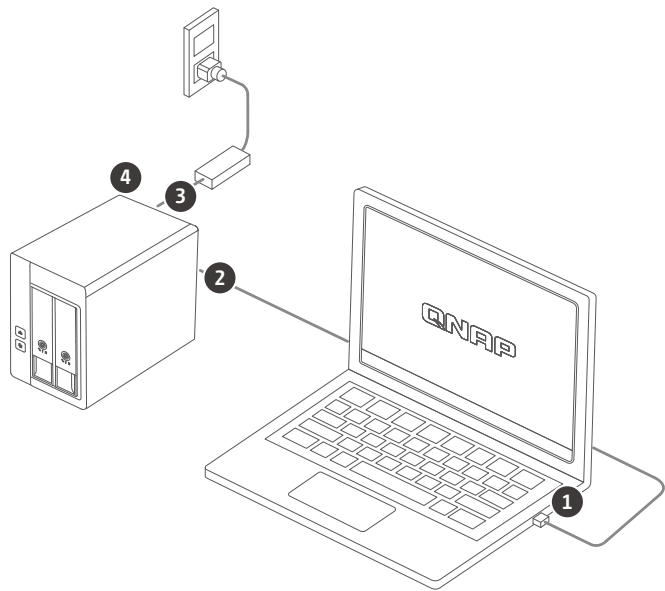
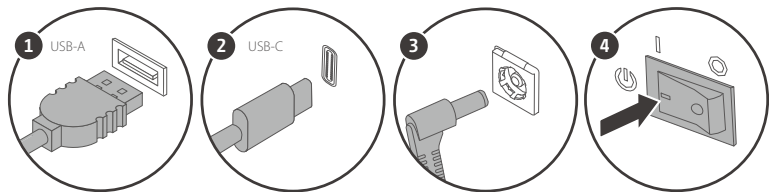

a

QNAP NAS

QTS Storage & Snapshots

b

Windows® / macOS

↓ www.qnap.com/download

QNAP External RAID Manager

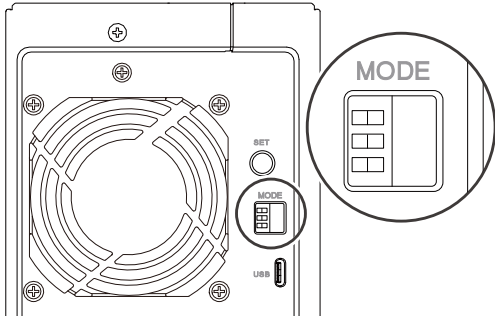

- Changing the RAID mode deletes all data. ----- en
- Durch das Ändern des RAID-Modus werden alle Daten gelöscht. ----- de
- La modification du mode RAID supprime toutes les données. ----- fr
- Al cambiar el modo de RAID se borran todos los datos. ----- es
- Door de RAID-modus te wijzigen, worden alle gegevens verwijderd. ----- nl
- Att ändra RAID-läge raderar all data ----- sv
- RAID-tilan muuttaminen poistaa kaikki tiedot. ----- fi
- Ændring af RAID-tilstand sletter alle data. ----- da
- Hvis du endrer RAID-modus, blir alle data slettet. ----- no
- Alterar o modo RAID, exclui todos os dados. ----- pt
- При изменении режима RAID все данные будут удалены. ----- ru
- 更改 RAID 模式将会删除所有数据。 ----- cn
- La modifica della modalità RAID comporta l'eliminazione di tutti i dati. ----- it
- 更換 RAID 模式將清除所有資料。 ----- tw
- RAID モードを変更すると、すべてのデータが削除されます。 ----- ja
- RAID 모드의 변경은 모든 데이터를 삭제합니다. ----- ko
- การเปลี่ยนโหมด RAID จะลบข้อมูลทั้งหมด ----- th
- RAID modu deęiřtiinildiginde t¼m veniler silinir. ----- tr
- A RAID-m¼d megv¼ltoztatása az ¼sszes adat t¼rlésével jár. ----- hu
- Zm¼na reęimu RAID odstrani vřechna data. ----- cs
- Zmiana trybu RAID usuwa wszystkie dane. ----- pl
- البيانات تغيير وضع RAID يحذف كل ----- ar

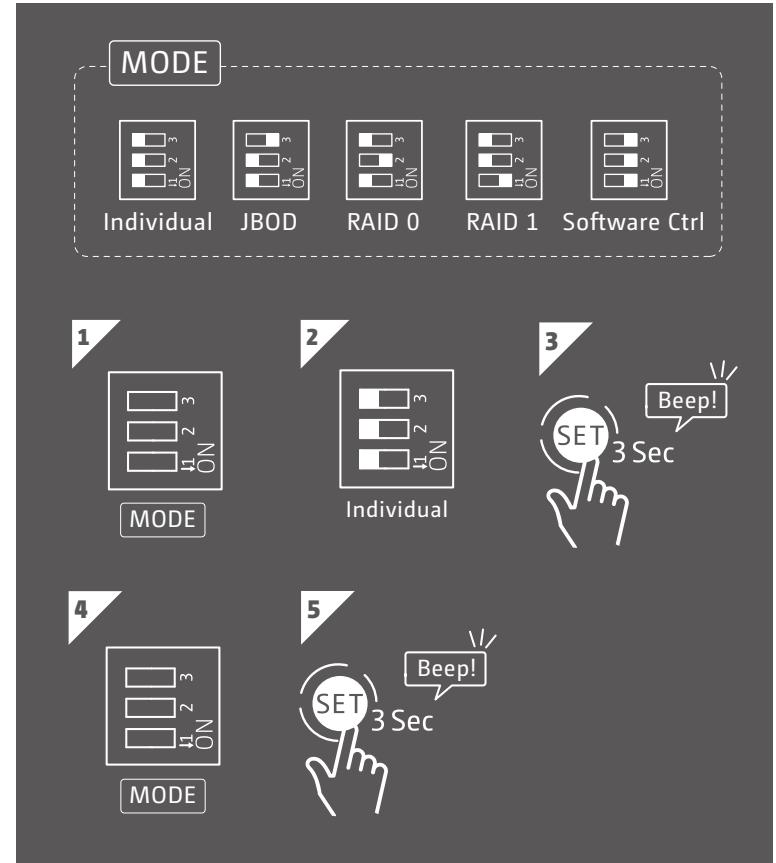

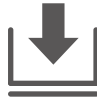

Download Center
www.qnap.com/download

- en Visit Download Center for our full guides and utilities. -----
- de Unsere vollständigen Handbücher und Dienstprogramme finden Sie im Download Center. -----
- fr Visitez le Centre de téléchargement pour accéder à nos guides et utilitaires complets. -----
- it Per le guide e le utilità complete, visitate il Centro download. -----
- es Visite el Centro de descargas para ver todas nuestras guías y utilidades. -----
- nl Bezoek het downloadcentrum voor onze uitgebreide gidsen en hulpprogramma's. -----
- sv Besök Nedladdningscenter för våra fullständiga guider och verktyg. -----
- fi Katso täydelliset oppaat ja apuohjelmat latauskeskuksestamme. -----
- da Besøg Downloadcenter for at se alle vores vejledninger og hjælpværktøjer. -----
- no Gå til Nedlastingscenter for fullstendige veiledninger og verktøy. -----
- pt Visite a Central de Download para acessar nossos guias e utilitários completos. -----
- ru Чтобы ознакомиться с полным набором руководств и служебных программ, посетите Центр загрузки. -----
- tw 請前往下載中心取得完整指南和應用工具。 -----
- cn 有关完整指南和实用工具，请访问“下载中心”。 -----
- ja 完全なガイドとユーティリティについては、ダウンロードセンターをご覧ください。 -----
- ko 다운로드 센터에서 전체 지침 및 유틸리티를 확인하십시오. -----
- th กรุณาเข้าศูนย์บริการดาวน์โหลดเพื่อดูคู่มือฉบับสมบูรณ์และโปรแกรมอรรถประโยชน์ต่าง ๆ -----
- tr Tam kılavuzumuz ve yardımcı hizmetlerimiz için İndirme Merkezi'ni ziyaret edin. -----
- hu A teljes útmutatók és segédprogramok megtekintéséhez keresse fel a Letöltési központot. -----
- cs Kompletního průvodce a nástroje najdete na webu Centrum stahování. -----
- pl Odwiedź Centrum pobierania, aby uzyskać kompletne przewodniki i narzędzia. -----
- ar المساعدة الكاملة للحصول على الأدوات والأدوات تفضل بزيارة مركز التنزيل. -----



This device complies with Part 15 of the FCC Rules. Operation is subject to the following two conditions:

1. This device may not cause harmful interference.
2. This device must accept any interference received, including interference that may cause undesired operation.

FCC Class B Notice:

This equipment has been tested and found to comply with the limits for a Class B digital device, pursuant to Part 15 of the FCC Rules. These limits are designed to provide reasonable protection against harmful interference in a residential installation. This equipment generates, uses, and can radiate radio frequency energy and, if not installed and used in accordance with the instructions, may cause harmful interference to radio communications. However, there is no guarantee that interference will not occur in a particular installation. If this equipment does cause harmful interference to radio or television reception, which can be determined by turning the equipment off and on, the user is encouraged to try to correct the interference by one or more of the following measures:

- Reorient or relocate the receiving antenna.
- Increase the separation between the equipment and receiver.
- Connect the equipment into an outlet on a circuit different from that to which the receiver is connected.
- Consult the dealer or an experienced radio/television technician for help.

Modifications:

Any modifications made to this device that are not approved by QNAP Systems, Inc. may void the authority granted to the user by the FCC to operate this equipment.



This QNAP NAS complies with CE Compliance Class B.



According to the requirement of the WEEE legislation the following user information is provided to customers for all branded QNAP products subject to the WEEE directive.

This symbol on the product or on its packaging indicates that this product must not be disposed of with your other household waste. Instead, it is your responsibility to dispose of your waste equipment by handing it over to a designated collection point for the recycling of waste electrical and electronic equipment. The separate collection and recycling of your waste equipment at the time of disposal will help to conserve natural resources and ensure that it is recycled in a manner that protects human health and the environment. For more information about where you can drop off your waste equipment for recycling, please contact your local city office, your household waste disposal service or the shop where you purchased the product.



更多關於安全、法規、與環境法令遵循相關的資訊，請參閱以下網址 www.qnap.com/regulatory/

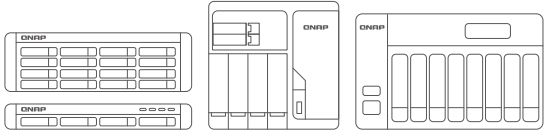

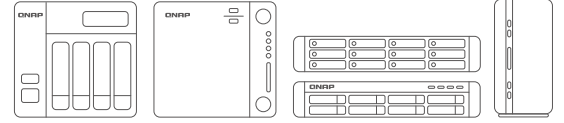



helpdesk.qnap.com



docs.qnap.com

QNAP

Printed in Taiwan
P/N: 51000-024595-RS