

**ROG STRIX  
X570-F GAMING**

**ASUS®**

**Motherboard**

E15201  
First Edition  
May 2019

**Copyright © 2019 ASUSTeK COMPUTER INC. All Rights Reserved.**

No part of this manual, including the products and software described in it, may be reproduced, transmitted, transcribed, stored in a retrieval system, or translated into any language in any form or by any means, except documentation kept by the purchaser for backup purposes, without the express written permission of ASUSTeK COMPUTER INC. ("ASUS").

Product warranty or service will not be extended if: (1) the product is repaired, modified or altered, unless such repair, modification of alteration is authorized in writing by ASUS; or (2) the serial number of the product is defaced or missing.

ASUS PROVIDES THIS MANUAL "AS IS" WITHOUT WARRANTY OF ANY KIND, EITHER EXPRESS OR IMPLIED, INCLUDING BUT NOT LIMITED TO THE IMPLIED WARRANTIES OR CONDITIONS OF MERCHANTABILITY OR FITNESS FOR A PARTICULAR PURPOSE. IN NO EVENT SHALL ASUS, ITS DIRECTORS, OFFICERS, EMPLOYEES OR AGENTS BE LIABLE FOR ANY INDIRECT, SPECIAL, INCIDENTAL, OR CONSEQUENTIAL DAMAGES (INCLUDING DAMAGES FOR LOSS OF PROFITS, LOSS OF BUSINESS, LOSS OF USE OR DATA, INTERRUPTION OF BUSINESS AND THE LIKE), EVEN IF ASUS HAS BEEN ADVISED OF THE POSSIBILITY OF SUCH DAMAGES ARISING FROM ANY DEFECT OR ERROR IN THIS MANUAL OR PRODUCT.

SPECIFICATIONS AND INFORMATION CONTAINED IN THIS MANUAL ARE FURNISHED FOR INFORMATIONAL USE ONLY, AND ARE SUBJECT TO CHANGE AT ANY TIME WITHOUT NOTICE, AND SHOULD NOT BE CONSTRUED AS A COMMITMENT BY ASUS. ASUS ASSUMES NO RESPONSIBILITY OR LIABILITY FOR ANY ERRORS OR INACCURACIES THAT MAY APPEAR IN THIS MANUAL, INCLUDING THE PRODUCTS AND SOFTWARE DESCRIBED IN IT.

Products and corporate names appearing in this manual may or may not be registered trademarks or copyrights of their respective companies, and are used only for identification or explanation and to the owners' benefit, without intent to infringe.

**Offer to Provide Source Code of Certain Software**

This product contains copyrighted software that is licensed under the General Public License ("GPL"), under the Lesser General Public License Version ("LGPL") and/or other Free Open Source Software Licenses. Such software in this product is distributed without any warranty to the extent permitted by the applicable law. Copies of these licenses are included in this product.

Where the applicable license entitles you to the source code of such software and/or other additional data, you may obtain it for a period of three years after our last shipment of the product, either

(1) for free by downloading it from <https://www.asus.com/support/>

or

(2) for the cost of reproduction and shipment, which is dependent on the preferred carrier and the location where you want to have it shipped to, by sending a request to:

ASUSTeK Computer Inc.  
Legal Compliance Dept.  
15 Li Te Rd.,  
Beitou, Taipei 112  
Taiwan

In your request please provide the name, model number and version, as stated in the About Box of the product for which you wish to obtain the corresponding source code and your contact details so that we can coordinate the terms and cost of shipment with you.

The source code will be distributed WITHOUT ANY WARRANTY and licensed under the same license as the corresponding binary/object code.

This offer is valid to anyone in receipt of this information.

ASUSTeK is eager to duly provide complete source code as required under various Free Open Source Software licenses. If however you encounter any problems in obtaining the full corresponding source code we would be much obliged if you give us a notification to the email address [gpl@asus.com](mailto:gpl@asus.com), stating the product and describing the problem (please DO NOT send large attachments such as source code archives, etc. to this email address).

# Contents

Safety information.....	v
About this guide.....	vi
ROG STRIX X570-F GAMING specifications summary.....	viii
Package contents.....	xii
Installation tools and components.....	xiii

## Chapter 1: Product Introduction

1.1	Motherboard overview.....	1-1
1.1.1	Before you proceed.....	1-1
1.1.2	Motherboard layout.....	1-2
1.1.3	Central Processing Unit (CPU).....	1-4
1.1.4	System memory.....	1-4
1.1.5	Expansion slots.....	1-6
1.1.6	Onboard LEDs.....	1-8
1.1.7	Headers.....	1-9
1.1.8	Internal connectors.....	1-12

## Chapter 2: Basic Installation

2.1	Building your PC system.....	2-1
2.1.1	Motherboard installation.....	2-1
2.1.2	CPU installation.....	2-3
2.1.3	CPU heatsink and fan assembly installation.....	2-4
2.1.4	DIMM installation.....	2-7
2.1.5	ATX power connection.....	2-8
2.1.6	SATA device connection.....	2-8
2.1.7	Front I/O connector.....	2-9
2.1.8	Expansion card installation.....	2-10
2.1.9	M.2 installation.....	2-11
2.3	Motherboard rear and audio connections.....	2-13
2.3.1	Rear I/O connection.....	2-13
2.3.2	Audio I/O connections.....	2-15
2.3	Starting up for the first time.....	2-17
2.4	Turning off the computer.....	2-17

## Chapter 3: BIOS Setup

3.1	Knowing BIOS.....	3-1
3.2	BIOS setup program.....	3-2
3.2.1	Advanced Mode.....	3-3
3.2.2	EZ Mode.....	3-6
3.2.3	Q-Fan Control.....	3-7

3.2.4	EZ Tuning Wizard .....	3-9
<b>3.3</b>	<b>My Favorites .....</b>	<b>3-10</b>
<b>3.4</b>	<b>Main menu .....</b>	<b>3-12</b>
<b>3.5</b>	<b>Ai Tweaker menu .....</b>	<b>3-12</b>
<b>3.6</b>	<b>Advanced menu .....</b>	<b>3-13</b>
3.6.1	AMD fTPM Configuration .....	3-13
3.6.2	CPU Configuration .....	3-13
3.6.3	Bixby IDE Configuration .....	3-14
3.6.4	SATA Configuration .....	3-14
3.6.5	Onboard Devices Configuration .....	3-15
3.6.6	APM Configuration .....	3-16
3.6.7	PCI Subsystem Settings .....	3-16
3.6.8	USB Configuration .....	3-16
3.6.9	HDD/SSD SMART Information .....	3-17
3.6.10	NVMe Configuration .....	3-17
3.6.11	Network Stack Configuration .....	3-17
3.6.12	AMD CBS .....	3-17
<b>3.7</b>	<b>Monitor menu .....</b>	<b>3-17</b>
<b>3.8</b>	<b>Boot menu .....</b>	<b>3-17</b>
<b>3.9</b>	<b>Tool menu .....</b>	<b>3-19</b>
3.9.1	ASUS EZ Flash 3 Utility .....	3-19
3.9.2	ASUS Secure Erase .....	3-19
3.9.3	ASUS User profile .....	3-20
3.9.4	ASUS SPD Information .....	3-20
3.9.5	Graphics Card Information .....	3-20
3.9.6	ASUS Armoury Crate .....	3-21
<b>3.10</b>	<b>Exit menu .....</b>	<b>3-21</b>
<b>3.11</b>	<b>Updating BIOS .....</b>	<b>3-21</b>
3.11.1	EZ Update .....	3-22
3.11.2	ASUS EZ Flash 3 .....	3-22
3.11.3	ASUS CrashFree BIOS 3 .....	3-24

## **Chapter 4: RAID Support**

<b>4.1</b>	<b>AMD RAID Array configurations .....</b>	<b>4-1</b>
4.1.1	RAID definitions .....	4-1

## **Appendix**

<b>Notices .....</b>	<b>A-1</b>
<b>ASUS contact information .....</b>	<b>A-5</b>

# Safety information

## Electrical safety

- To prevent electrical shock hazard, disconnect the power cable from the electrical outlet before relocating the system.
- When adding or removing devices to or from the system, ensure that the power cables for the devices are unplugged before the signal cables are connected. If possible, disconnect all power cables from the existing system before you add a device.
- Before connecting or removing signal cables from the motherboard, ensure that all power cables are unplugged.
- Seek professional assistance before using an adapter or extension cord. These devices could interrupt the grounding circuit.
- Ensure that your power supply is set to the correct voltage in your area. If you are not sure about the voltage of the electrical outlet you are using, contact your local power company.
- If the power supply is broken, do not try to fix it by yourself. Contact a qualified service technician or your retailer.

## Operation safety

- Before installing the motherboard and adding devices on it, carefully read all the manuals that came with the package.
- Before using the product, ensure all cables are correctly connected and the power cables are not damaged. If you detect any damage, contact your dealer immediately.
- To avoid short circuits, keep paper clips, screws, and staples away from connectors, slots, sockets and circuitry.
- Avoid dust, humidity, and temperature extremes. Do not place the product in any area where it may become wet.
- Place the product on a stable surface.
- If you encounter technical problems with the product, contact a qualified service technician or your retailer.

## About this guide

This user guide contains the information you need when installing and configuring the motherboard.

## How this guide is organized

This guide contains the following parts:

- **Chapter 1: Product Introduction**  
This chapter describes the features of the motherboard and the new technology it supports. It includes description of the switches, jumpers, and connectors on the motherboard.
- **Chapter 2: Basic Installation**  
This chapter lists the hardware setup procedures that you have to perform when installing system components.
- **Chapter 3: BIOS Setup**  
This chapter tells how to change system settings through the BIOS Setup menus. Detailed descriptions of the BIOS parameters are also provided.
- **Chapter 4: RAID Support**  
This chapter describes the RAID configurations.

## Where to find more information

Refer to the following sources for additional information and for product and software updates.

1. **ASUS website**  
The ASUS website ([www.asus.com](http://www.asus.com)) provides updated information on ASUS hardware and software products.
2. **Optional documentation**  
Your product package may include optional documentation, such as warranty flyers, that may have been added by your dealer. These documents are not part of the standard package.

## Conventions used in this guide

To ensure that you perform certain tasks properly, take note of the following symbols used throughout this manual.



**DANGER/WARNING:** Information to prevent injury to yourself when trying to complete a task.



**CAUTION:** Information to prevent damage to the components when trying to complete a task.



**IMPORTANT:** Instructions that you **MUST** follow to complete a task.



**NOTE:** Tips and additional information to help you complete a task.

## Typography

**Bold text**

Indicates a menu or an item to select.

*Italics*

Used to emphasize a word or a phrase.

<Key>

Keys enclosed in the less-than and greater-than sign means that you must press the enclosed key.

Example: <Enter> means that you must press the Enter or Return key.

<Key1> + <Key2> + <Key3>

If you must press two or more keys simultaneously, the key names are linked with a plus sign (+).

## ROG STRIX X570-F GAMING specifications summary

<b>CPU</b>	<p>AMD AM4 Socket for 3<sup>rd</sup> and 2<sup>nd</sup> Gen AMD Ryzen™/2<sup>nd</sup> and 1<sup>st</sup> Gen AMD Ryzen™ with Radeon™ Vega Graphics Processors</p> <p>** Refer to <a href="http://www.asus.com">www.asus.com</a> for the AMD CPU support list.</p>
<b>Chipset</b>	AMD X570 Chipset
<b>Memory</b>	<p><b>3<sup>rd</sup> Gen AMD Ryzen™ Processors</b></p> <p>- 4 x DIMM, max. 128GB, DDR4 4400(O.C.)/4266(O.C.)/4133(O.C.)/4000(O.C.)/3866(O.C.)/3733(O.C.)/3600(O.C.)/3466(O.C.)/3400(O.C.)/3200(O.C.)/3000(O.C.)/2933(O.C.)/2800(O.C.)/2666/2400/2133 MHz, un-buffered memory</p> <p><b>2<sup>nd</sup> Gen AMD Ryzen™ Processors</b></p> <p>- 4 x DIMM, max. 128GB, DDR4 3600(O.C.)/3466(O.C.)/3400(O.C.)/3200(O.C.)/3000(O.C.)/2933(O.C.)/2800(O.C.)/2666/2400/2133 MHz, un-buffered memory</p> <p><b>2<sup>nd</sup> and 1<sup>st</sup> Gen AMD Ryzen™ with Radeon™ Vega Graphics Processors</b></p> <p>- 4 x DIMM, max. 128GB, DDR4 3200(O.C.)/3000(O.C.)/2933(O.C.)/2800(O.C.)/2666/2400/2133 MHz, un-buffered memory</p> <p>Dual channel memory architecture</p> <p>* Refer to <a href="http://www.asus.com">www.asus.com</a> for the Memory QVL (Qualified Vendors List).</p>
<b>Expansion slots</b>	<p><b>3<sup>rd</sup> Gen AMD Ryzen™ Processors</b></p> <p>2 x PCIe 4.0 x16 SafeSlots (supports x16, x8/x8)</p> <p><b>2<sup>nd</sup> Gen AMD Ryzen™ Processors</b></p> <p>2 x PCIe 3.0 x16 SafeSlots (supports x16, x8/x8)</p> <p><b>2<sup>nd</sup> and 1<sup>st</sup> Gen AMD Ryzen™ with Radeon™ Vega Graphics Processors</b></p> <p>1 x PCIe 3.0 x16 SafeSlot (supports x8)</p> <p><b>AMD X570 chipset</b></p> <p>1 x PCIe 4.0 x16 (supports x4)</p> <p>2 x PCIe 4.0 x 1 slots</p>
<b>Graphics</b>	<p><b>Integrated Graphics in 2<sup>nd</sup> and 1<sup>st</sup> Gen AMD Ryzen™ with Radeon™ Vega Graphics Processors</b></p> <p>Multi-VGA output support: HDMI and DisplayPort ports</p> <ul style="list-style-type: none"> <li>- Supports HDMI 2.0b with maximum resolution of 4096 x 2160 @60Hz</li> <li>- Supports DisplayPort 1.2 with maximum resolution of 4096 x 2160@60Hz</li> </ul>
<b>Multi-GPU support</b>	<p><b>3<sup>rd</sup> and 2<sup>nd</sup> Gen AMD Ryzen™ Processors</b></p> <ul style="list-style-type: none"> <li>- Supports NVIDIA® 2-Way SLI® Technology</li> <li>- Supports AMD 3-way CrossFireX™ Technology</li> </ul> <p><b>2<sup>nd</sup> and 1<sup>st</sup> Gen AMD Ryzen™ with Radeon™ Vega Graphics Processors</b></p> <ul style="list-style-type: none"> <li>- Supports AMD 2-way CrossFireX™ Technology</li> </ul>

(continued on the next page)



## ROG STRIX X570-F GAMING specifications summary

<p><b>Storage</b></p>	<p><b>3<sup>rd</sup> Gen AMD Ryzen™ Processors</b></p> <ul style="list-style-type: none"> <li>- 1 x M.2 Socket 3 with M Key, Type 2242/2260/2280/22110 storage devices support (PCIe 4.0 x 4 and SATA modes)</li> </ul> <p><b>2<sup>nd</sup> Gen AMD Ryzen™/2<sup>nd</sup> and 1<sup>st</sup> Gen AMD Ryzen™ with Radeon™ Vega Graphics Processors</b></p> <ul style="list-style-type: none"> <li>- 1 x M.2 Socket 3 with M Key, Type 2242/2260/2280/22110 storage devices support (PCIe 3.0 x 4 and SATA modes)</li> </ul> <p><b>AMD X570 Chipset:</b></p> <ul style="list-style-type: none"> <li>- 1 x M.2 socket 3 with M Key, Type 2242/2260/2280/22110 (PCIe 4.0 x 4 and SATA modes) storage devices support</li> <li>- 8 x SATA 6.0 Gb/s connectors</li> <li>- Support RAID 0, 1, 10</li> </ul>
<p><b>LAN</b></p>	<p>Intel® Ethernet Controller I211-AT</p> <p>Anti-surge LANGuard</p> <p>ROG GameFirst Technology</p>
<p><b>Audio</b></p>	<p><b>ROG SupremeFX 8-Channel High Definition Audio S1220A CODEC</b></p> <ul style="list-style-type: none"> <li>- Supports up to 32-Bit/192kHz playback*</li> <li>- High quality 120 dB SNR stereo playback output and 113 dB SNR recording input</li> <li>- Impedance sense for front and rear headphone outputs</li> <li>- SupremeFX Shielding Technology</li> <li>- Dual Op Amplifiers</li> <li>- Jack-detection, Multi-streaming, and Front Panel Jack-retasking</li> <li>- Optical S/PDIF out port at back panel</li> </ul> <p><b>Audio Features</b></p> <ul style="list-style-type: none"> <li>- Sonic Studio III + Sonic Studio Virtual Mixer</li> <li>- Sonic Radar III</li> <li>- DTS® Sound Unbound</li> </ul> <p>* Due to limitations in the HDA bandwidth, 32-Bit/192kHz is not supported for 8-Channel audio.</p>
<p><b>USB</b></p>	<p><b>3<sup>rd</sup> and 2<sup>nd</sup> Gen AMD Ryzen™/2<sup>nd</sup> and 1<sup>st</sup> Gen AMD Ryzen™ with Radeon™ Vega Graphics Processors</b></p> <ul style="list-style-type: none"> <li>- 4 x USB 3.2 Gen1 ports (4 ports at back panel, Type-A)</li> </ul> <p><b>AMD X570 chipset</b></p> <ul style="list-style-type: none"> <li>- 1 x USB 3.2 Gen2 front panel connector</li> <li>- 4 x USB 3.2 Gen2 (at back panel, 3 x Type-A, 1 x Type-C)</li> <li>- 2 x USB 3.2 Gen1 ports (at front panel)</li> <li>- 4 x USB 2.0 ports (at front panel)</li> </ul>

*(continued on the next page)*

## ROG STRIX X570-F GAMING specifications summary

<p><b>ROG Exclusive Features</b></p>	<p><b>Digi+ VRM</b></p> <ul style="list-style-type: none"> <li>- Dr. Mos</li> <li>- Alloy Chokes</li> <li>- 5K Black Metallic Capacitors</li> </ul> <p>RAMCache III GameFirst V Sonic Studio III +Sonic Studio Virtual Mixer Sonic Radar III CPU-Z</p>
<p><b>Special Features</b></p>	<p><b>ASUS Exclusive Software Features</b></p> <ul style="list-style-type: none"> <li>- <b>Armoury Crate</b></li> <li>- <b>AURA</b></li> <li>- Aura Lighting Control,Aura Addressable Gen2 Header(s), Aura RGB Strip Headers, Aura Lighting Effects Synchronization with compatible ASUS ROG devices</li> <li>- <b>AI Suite 3</b></li> <li>- <b>ASUS EZ DIY</b></li> <li>- ASUS CrashFree BIOS 3</li> <li>- ASUS EZ Flash 3</li> </ul> <p><b>Fan Xpert4</b></p> <ul style="list-style-type: none"> <li>- Fan Xpert 4 featuring Fan Auto Tuning function and multiple thermistors selection for optimized system cooling control</li> </ul> <p><b>ASUS Exclusive Hardware Features</b></p> <ul style="list-style-type: none"> <li>- ROG patented pre-mounted I/O shield</li> <li>- OptiMem</li> <li>- Ai Charger</li> <li>- ASUS NODE: hardware control interface</li> <li>- BIOS Flashback™ button</li> </ul> <p><b>ASUS Q-Design</b></p> <ul style="list-style-type: none"> <li>- Q-LED</li> <li>- Q-Slot</li> <li>- Q-DIMM</li> </ul> <p><b>Gamer's Guardian</b></p> <ul style="list-style-type: none"> <li>- DRAM Overcurrent Protection</li> <li>- ESD Guards on LAN, Audio, KBMS and USB ports</li> <li>- Highly Durable Components</li> <li>- SafeSlot</li> <li>- Procool</li> <li>- DIGI+ VRM</li> </ul>

*(continued on the next page)*

## ROG STRIX X570-F GAMING specifications summary

<b>Back I/O Ports</b>	<ul style="list-style-type: none"> <li>1 x HDMI port</li> <li>1 x DisplayPort</li> <li>1 x BIOS Flashback™ button</li> <li>1 x BIOS Flashback™ LED</li> <li>4 x USB 3.2 Gen2 ports (3 x Type-A, 1 x Type-C)</li> <li>4 x USB 3.2 Gen1 ports</li> <li>1 x Anti-surge LAN (RJ45) port</li> <li>1 x Optical S/PDIF out</li> <li>5 x Gold-plated audio jacks</li> </ul>
<b>Internal I/O Ports</b>	<ul style="list-style-type: none"> <li>1 x NODE connector</li> <li>1 x USB 3.2 Gen2 front panel connector</li> <li>1 x USB 3.2 Gen1 header supports additional 2 USB 3.2 Gen 1 ports</li> <li>2 x USB 2.0 connectors support additional 4 USB 2.0 ports</li> <li>1 x SPI TPM header</li> <li>8 x SATA 6Gb/s connectors</li> <li>2 x M.2 Socket 3 for M Key, type 2242/2260/2280/22110 devices (support PCIE and SATA modes)</li> <li>1 x 4-Pin CPU_FAN connector</li> <li>1 x 4-Pin CPU_OPT fan connector</li> <li>1 x 4-Pin AIO_PUMP connector</li> <li>1 x 4-Pin W_PUMP+ connector</li> <li>2 x 4-Pin CHA_FAN connectors</li> <li>1 x 4-Pin M.2_FAN connector</li> <li>1 x PCH_FAN connector</li> <li>1 x T_SENSOR connector</li> <li>2 x AURA Addressable Gen2 headers</li> <li>2 x AURA RGB headers</li> <li>1 x 24-pin EATX power connector</li> <li>1 x 8-pin EATX 12V power connector</li> <li>1 x 4-pin EATX 12V power connector</li> <li>1 x System panel connector</li> <li>1 x Front panel audio connector (AAFP)</li> <li>1 x Clear CMOS jumper (2-pin)</li> </ul>
<b>BIOS</b>	256 Mb Flash ROM, UEFI AMI BIOS, PnP, WfM2.0, SM BIOS 3.2, ACPI 6.2
<b>Manageability</b>	WOL, PXE
<b>Support DVD contents</b>	<ul style="list-style-type: none"> <li>Overwolf</li> <li>ASUS Utilities</li> <li>WinRAR</li> <li>Anti-virus software (OEM version)</li> </ul>
<b>Operating System Support</b>	Windows® 10 64-bit
<b>Form Factor</b>	ATX Form Factor, 12"x 9.6" (30.5 cm x 24.4 cm)



Specifications are subject to change without notice.

# Package contents



Check your motherboard package for the following items.

Motherboard	ROG STRIX X570-F GAMING
Cables	1 x 4-in-1 SATA 6Gb/s Cable
	1 x Extension Cable for RGB strips
	1 x Extension Cable for RGB Addressable strips
	1 x Thermistor cable
Accessories	1 x 2-in-1 M.2 Screws Package
	1 x ROG STRIX door hanger
	1 x ROG STRIX sticker
	1 x ROG thank you card
	1 x cable tie package
	1 x Cablemod coupon
Application DVD	ROG STRIX motherboard support DVD
Documentation	User guide

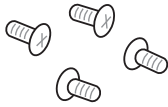

If any of the above items is damaged or missing, contact your retailer.

## Installation tools and components

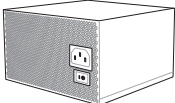
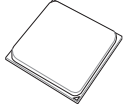
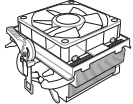
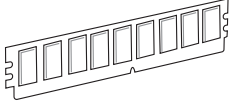
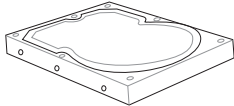
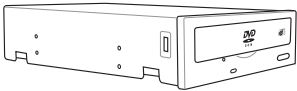
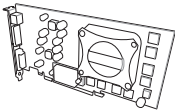
	
<b>1 Bag of screws</b>	<b>Phillips (cross) screwdriver</b>
	
<b>PC chassis</b>	<b>Power supply unit</b>
	
<b>AMD AM4 CPU</b>	<b>AMD AM4/AM3 compatible CPU Fan</b>
	
<b>DDR4 DIMM</b>	<b>SATA hard disk drive</b>
	
<b>SATA optical disc drive (optional)</b>	<b>Graphics card (optional)</b>



The tools and components in the table above are not included in the motherboard package.



# Product Introduction

# 1

## 1.1 Motherboard overview

### 1.1.1 Before you proceed

Take note of the following precautions before you install motherboard components or change any motherboard settings.



- 
- Unplug the power cord from the wall socket before touching any component.
  - Before handling components, use a grounded wrist strap or touch a safely grounded object or a metal object, such as the power supply case, to avoid damaging them due to static electricity.
  - Hold components by the edges to avoid touching the ICs on them.
  - Whenever you uninstall any component, place it on a grounded antistatic pad or in the bag that came with the component.
  - Before you install or remove any component, ensure that the ATX power supply is switched off or the power cord is detached from the power supply. Failure to do so may cause severe damage to the motherboard, peripherals, or components.
-

## 1.1.2 Motherboard layout

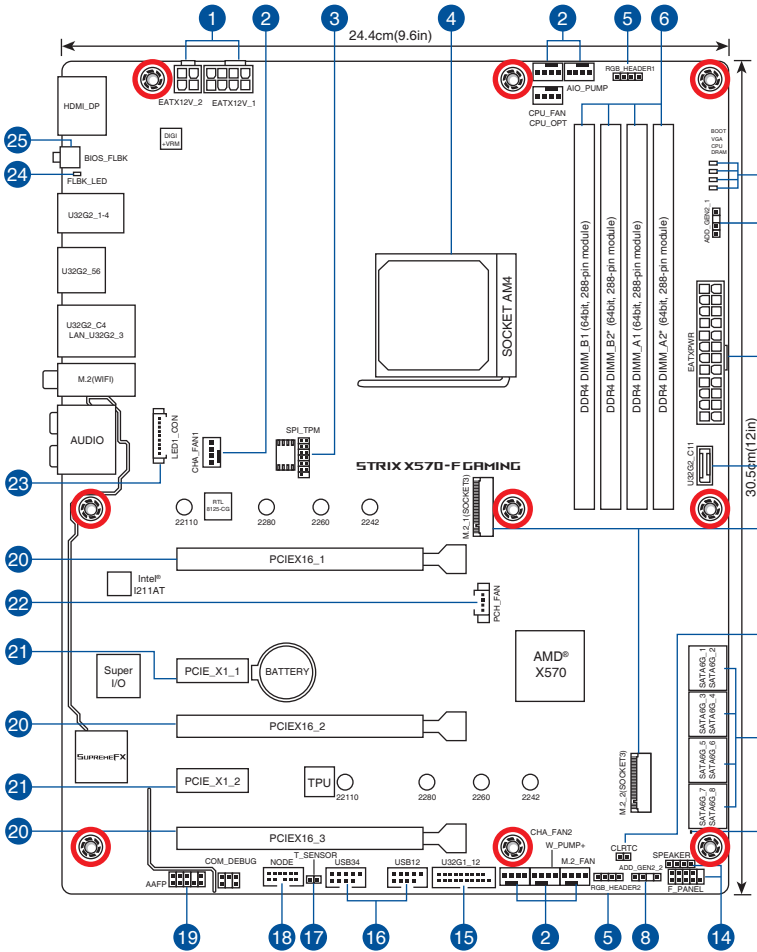

Refer to **1.1.8 Internal connectors** and **2.2.1 Rear I/O connection** for more information about rear panel connectors and internal connectors.



## Layout contents

Connectors/Jumpers/Buttons and switches/Slots	Page
1. ATX power connectors (24-pin EATXPWR; 8-pin EATX12V)	1-18
2. CPU, CPU optional, and chassis fan connectors; water pump+, M.2 fan, and AIO pump connectors (4-pin CPU_FAN, 4-pin CPU_OPT, 4-pin CHA_FAN1-2; 4-pin W_PUMP+, 4-pin M.2_FAN, 4-pin AIO_PUMP)	1-17
3. SPI TPM connector (14-1 pin SPI_TPM)	1-20
4. AM4 CPU socket	1-4
5. AURA RGB headers (4-pin RGB_HEADER1/2)	1-10
6. DDR4 DIMM slots	1-4
7. Q LEDs (DRAM, CPU, VGA, BOOT)	1-8
8. Addressable RGB header (4-1 pin ADD_GEN2_1/2)	1-11
9. USB 3.2 Gen 2 front panel connector (U32G2_C11)	1-14
10. M.2 sockets (M.2_1/2)	1-19
11. Clear RTC RAM jumper (2-pin CLRTC)	1-9
12. AMD Serial ATA 6 Gb/s connectors (7-pin SATA6G_1-8)	1-13
13. Standby power LED (SB_PWR)	1-8
14. System panel connectors (10-1 pin PANEL, 4-pin SPEAKER)	1-16
15. USB 3.2 Gen1 front panel connector (U32G1_12)	1-14
16. USB 2.0 connectors (10-1 pin USB12, USB34)	1-15
17. Thermal sensor connector (2-pin T_SENSOR)	1-12
18. NODE connector (12-1 pin NODE)	1-20
19. Front panel audio connector (10-1 pin AAFP)	1-12
20. PCIe 4.0/3.0 x16 slot (PCIE_X16_1/2/3)	1-5
21. PCIe 4.0 x1 slot (PCIE_X1_1/2)	1-5
22. PCH fan connectors (4-pin PCH_FAN)	1-21
23. LED connector (13-pin LED1_CON1)	1-15
24. BIOS Flashback LED (FLBK_LED)	1-9
25. BIOS Flashback button (BIOS_FLBK)	2-12

### 1.1.3 Central Processing Unit (CPU)

The motherboard comes with an AM4 socket designed for AMD AM4 Socket for 3<sup>rd</sup> and 2<sup>nd</sup> Gen AMD Ryzen™/2<sup>nd</sup> and 1<sup>st</sup> Gen AMD Ryzen™ with Radeon™ Vega Graphics Processors.

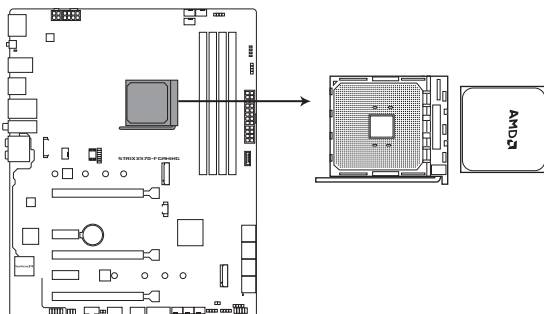

**ROG STRIX X570-F GAMING CPU socket AM4**



The AM4 socket has a different pinout design. Ensure that you use a CPU designed for the AM4 socket. The CPU fits in only one correct orientation. **DO NOT** force the CPU into the socket to prevent bending the connectors on the socket and damaging the CPU!



Ensure that all power cables are unplugged before installing the CPU.

### 1.1.4 System memory

The motherboard comes with four Double Data Rate 4 (DDR4) Dual Inline Memory Modules (DIMM) slots.



A DDR4 module is notched differently from a DDR, DDR2, or DDR3 module. **DO NOT** install a DDR, DDR2, or DDR3 memory module to the DDR4 slot.

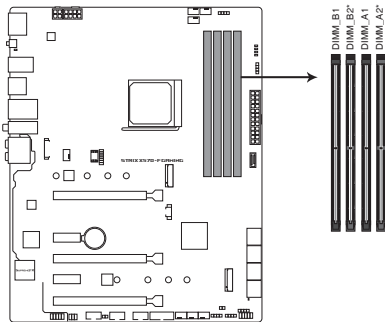

**ROG STRIX X570-F GAMING  
288-pin DDR4 DIMM sockets**

## Recommended memory configurations

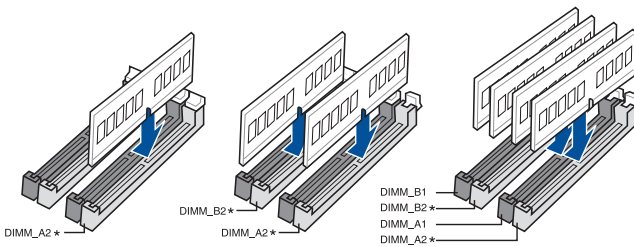

## Memory configurations

You may install 2 GB, 4 GB, 8 GB, and 16 GB unbuffered DDR4 DIMMs into the DIMM sockets.



- You may install varying memory sizes in Channel A and Channel B. The system maps the total size of the lower-sized channel for the dual-channel configuration. Any excess memory from the higher-sized channel is then mapped for single-channel operation.
- This motherboard does not support DIMMs made up of 512 Mb (64 MB) chips or less (Memory chip capacity counts in Megabit, 8 Megabit/Mb = 1 Megabyte/MB).



- The default memory operation frequency is dependent on its Serial Presence Detect (SPD), which is the standard way of accessing information from a memory module. Under the default state, some memory modules for overclocking may operate at a lower frequency than the vendor-marked value.
- For system stability, use a more efficient memory cooling system to support a full memory load (4 DIMMs) or overclocking condition.
- Always install the DIMMS with the same CAS Latency. For an optimum compatibility, we recommend that you install memory modules of the same version or data code (D/C) from the same vendor. Check with the vendor to get the correct memory modules.

## 1.1.5 Expansion slots



Unplug the power cord before adding or removing expansion cards. Failure to do so may cause you physical injury and damage motherboard components.

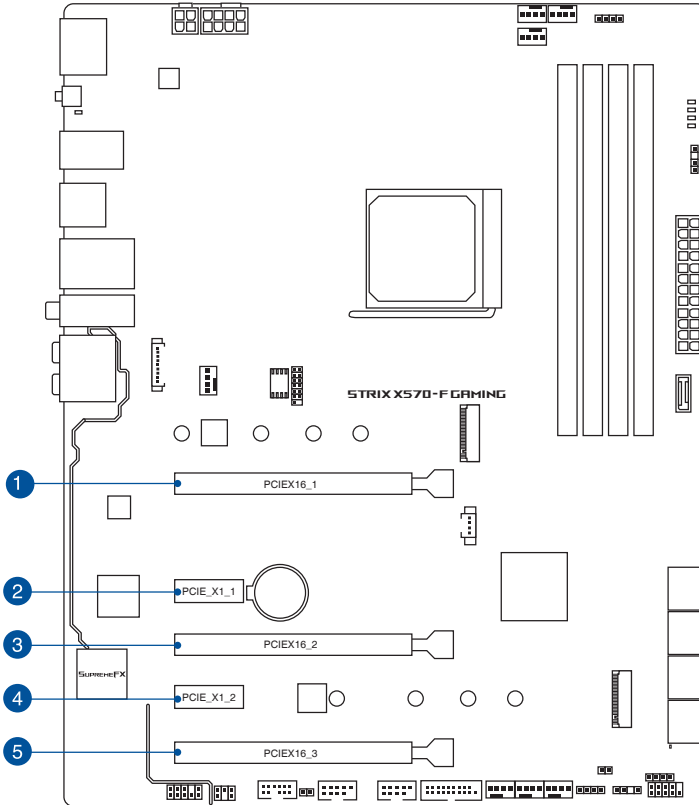

Slot No.	Slot Description
1	PCIe 4.0/3.0 x16_1 slot
2	PCIe 4.0 x1_1 slot
3	PCIe 4.0/3.0 x16_2 slot
4	PCIe 4.0 x1_2 slot
5	PCIe 4.0 x16_3 slot

## PCIe operating mode

### 3<sup>rd</sup> Gen AMD Ryzen™ Processors

Slot Description	PCIe operating mode		
	Single VGA / PCIe card	Dual VGA / PCIe card	Triple VGA / PCIe card
PCIe x16_1	x16 (PCIe 4.0)	x8 (PCIe 4.0)	x8 (PCIe 4.0)
PCIe x16_2	N/A	x8 (PCIe 4.0)	x8 (PCIe 4.0)
PCIe x16_3	N/A	N/A	x4 (PCIe 4.0)
M.2_1 (PCIe Mode)	x4 (PCIe 4.0)	x4 (PCIe 4.0)	x4 (PCIe 4.0)
M.2_1 (SATA Mode)	Support	Support	Support
M.2_2 (PCIe Mode)	x4 (PCIe 4.0)	x4 (PCIe 4.0)	x4 (PCIe 4.0)
M.2_2 (SATA Mode)	Support	Support	Support

### 2<sup>nd</sup> Gen AMD Ryzen™ Processors

Slot Description	PCIe operating mode		
	Single VGA / PCIe card	Dual VGA / PCIe card	Triple VGA / PCIe card
PCIe x16_1	x16 (PCIe 3.0)	x8 (PCIe 3.0)	x8 (PCIe 3.0)
PCIe x16_2	N/A	x8 (PCIe 3.0)	x8 (PCIe 3.0)
PCIe x16_3	N/A	N/A	x4 (PCIe 4.0)
M.2_1 (PCIe Mode)	x4 (PCIe 4.0)	x4 (PCIe 4.0)	x4 (PCIe 4.0)
M.2_1 (SATA Mode)	Support	Support	Support
M.2_2 (PCIe Mode)	x4 (PCIe 4.0)	x4 (PCIe 4.0)	x4 (PCIe 4.0)
M.2_2 (SATA Mode)	Support	Support	Support

### 2<sup>nd</sup> and 1<sup>st</sup> Gen AMD Ryzen™ with Radeon™ Vega Graphics

Slot Description	PCIe operating mode		
	Single VGA / PCIe card	Dual VGA / PCIe card	Triple VGA / PCIe card
PCIe x16_1	x8 (PCIe 3.0)	x8 (PCIe 3.0)	N/A
PCIe x16_2	N/A	N/A	N/A
PCIe x16_3	N/A	x4 (PCIe 4.0)	N/A
M.2_1 (PCIe Mode)	x4 (PCIe 4.0)	x4 (PCIe 4.0)	x4 (PCIe 4.0)
M.2_1 (SATA Mode)	Support	Support	Support
M.2_2 (PCIe Mode)	x4 (PCIe 4.0)	x4 (PCIe 4.0)	x4 (PCIe 4.0)
M.2_2 (SATA Mode)	Support	Support	Support



- We recommend that you provide sufficient power when running CrossFireX™ or SLI® mode.
- Ensure to connect the 8-pin and 4-pin power plugs when running CrossFireX™ or SLI mode.
- Connect chassis fans to the motherboard chassis fan connectors when using multiple graphics cards for better thermal environment.

## 1.1.6 Onboard LEDs

### 1. Q LEDs (DRAM, CPU, VGA, BOOT)

Q LEDs check key components (DRAM, CPU, VGA card, and booting devices) in sequence during motherboard booting process. If an error is found, the corresponding LED remains lit until the problem is solved. This user-friendly design provides an intuitive way to locate the root problem within seconds.

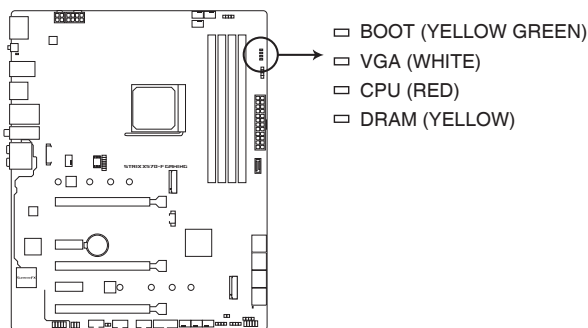

**ROG STRIX X570-F GAMING  
CPU/ DRAM/ BOOT/ VGA LED**



The order which the LEDs light up may vary per CPU.

### 2. Standby Power LED (SB\_PWR)

The motherboard comes with a standby power LED. The LED lights up to indicate that the system is ON, in sleep mode, or in soft-off mode. This is a reminder that you should shut down the system and unplug the power cable before removing or plugging in any motherboard component. The illustration below shows the location of the onboard LED.

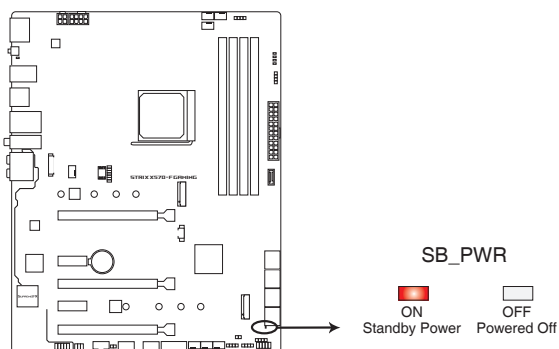

**ROG STRIX X570-F GAMING Standby power LED**

### 3. BIOS Flashback LED (FLBK\_LED)

The FLBK LED lights when the USB Flashback button is pressed for three seconds.

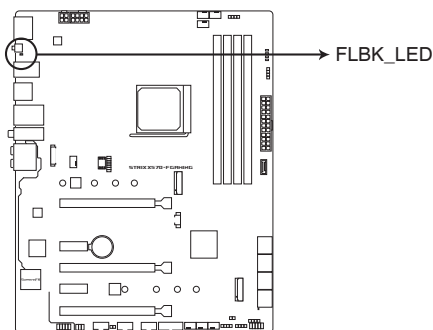

**ROG STRIX X570-F GAMING FLBK\_LED**

## 1.1.7 Headers

### 1. Clear RTC RAM jumper (2-pin CLRRTC)

This jumper allows you to clear the CMOS RTC RAM data of the system setup information such as date, time, and system passwords.

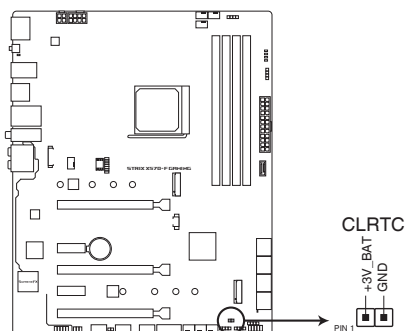

**ROG STRIX X570-F GAMING Clear RTC RAM**

To erase the RTC RAM:

1. Turn OFF the computer and unplug the power cord.
2. Use a metal object such as a screwdriver to short the two pins.
3. Plug the power cord and turn ON the computer.
4. Hold down the <Del> key during the boot process and enter BIOS setup to re-enter data.



If the steps above do not help, remove the onboard battery and short the two pins again to clear the CMOS RTC RAM data. After clearing the CMOS, reinstall the battery.

## 2. AURA RGB header (4-pin RGB\_HEADER1/2)

These connectors are for RGB LED strips.

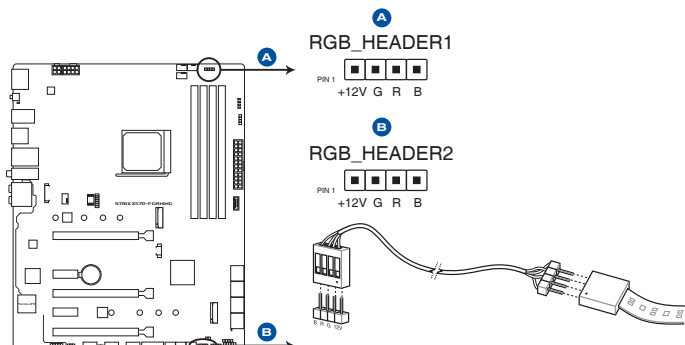

**ROG STRIX X570-F GAMING RGB\_HEADER connectors**



The RGB header supports 5050 RGB multi-color LED strips (12V/G/R/B), with a maximum power rating of 3A (12V), and no longer than 3 m.



Before you install or remove any component, ensure that the ATX power supply is switched off or the power cord is detached from the power supply. Failure to do so may cause severe damage to the motherboard, peripherals, or components.



- Actual lighting and color will vary with LED strip.
- If your LED strip does not light up, check if the RGB LED extension cable and the RGB LED strip is connected in the correct orientation, and the 12V connector is aligned with the 12V header on the motherboard.
- The LED strip will only light up when the system is operating.
- The LED strip is purchased separately.



### 3. Addressable RGB header (4-1 pin ADD\_GEN2\_1/2)

These connectors are for individually addressable RGB WS2812B LED strips with embedded WS2811 LED driver ICs.

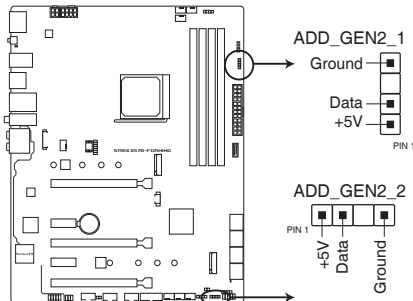

**ROG STRIX X570-F GAMING ADD\_HEADER headers**



The addressable RGB header supports WS2812B addressable RGB LED strips (5V/Data/Ground), with a maximum power rating of 3A (5V) and a maximum of 120 LEDs.



Before you install or remove any component, ensure that the ATX power supply is switched off or the power cord is detached from the power supply. Failure to do so may cause severe damage to the motherboard, peripherals, or components.



- Actual lighting and color will vary with LED strip.
- If your LED strip does not light up, check if the addressable RGB LED strip is connected in the correct orientation, and the 5V connector is aligned with the 5V header on the motherboard.
- The addressable RGB LED strip will only light up under the operating system.
- The addressable RGB LED strip is purchased separately.

#### 4. Thermal sensor connector (2-pin T\_SENSOR)

This connector is for the thermistor cable that monitors the temperature of the devices and the critical components inside the motherboard.

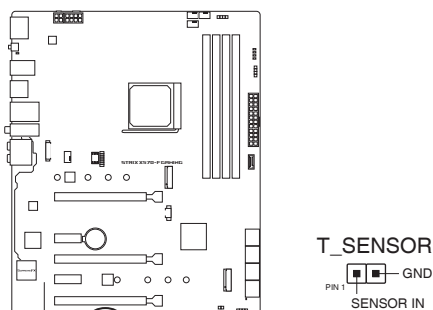

**ROG STRIX X570-F GAMING T\_SENSOR connector**

### 1.1.8 Internal connectors

#### 1. Front panel audio connector (10-1 pin AAFP)

This connector is for a chassis-mounted front panel audio I/O module that supports HD Audio. Connect one end of the front panel audio I/O module cable to this connector.

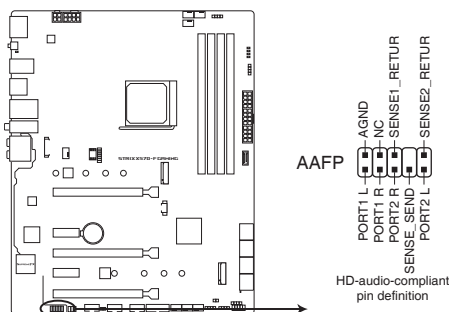

**ROG STRIX X570-F GAMING Analog front panel connector**



We recommend that you connect a high-definition front panel audio module to this connector to avail of the motherboard's high-definition audio capability.

## 2. AMD Serial ATA 6 Gb/s connectors (7-pin SATA6G\_1-8)

These connectors connect to Serial ATA 6 Gb/s hard disk drives via Serial ATA 6 Gb/s signal cables.

If you installed Serial ATA hard disk drives, you can create a RAID 0, RAID 1, and RAID 10 configuration through the onboard AMD X570 chipset.

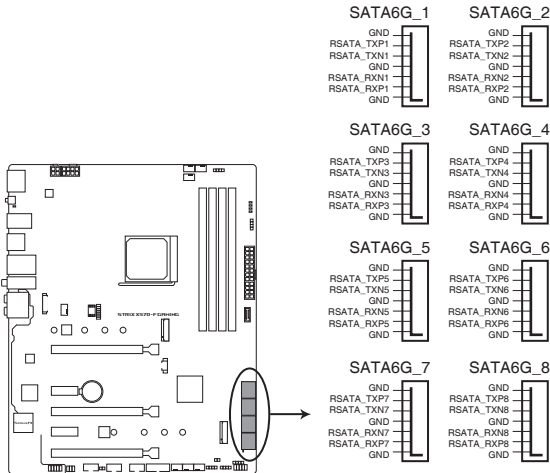

**ROG STRIX X570-F GAMING SATA 6 Gb/s connectors**

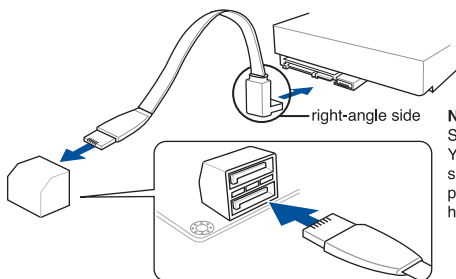

**NOTE:** Connect the right-angle side of SATA signal cable to SATA device. You may also connect the right-angle side of SATA cable to the onboard SATA port to avoid mechanical conflict with huge graphics cards.



- These connectors are set to **[AHCI]** by default. If you intend to create a Serial ATA RAID set using these connectors, set the SATA Mode Selection item in the BIOS to **[RAID]**.
- Before creating a RAID set, refer to section **RAID configurations** or the manual bundled in the motherboard support DVD.
- When using NCQ, set the SATA Mode in the BIOS to **[AHCI]**. Refer to section **SATA Configuration** for details.



## 5. USB 2.0 connectors (10-1 pin USB12; USB34)

These connectors are for USB 2.0 ports. Connect the USB module cable to any of these connectors, then install the module to a slot opening at the back of the system chassis. These USB connectors comply with USB 2.0 specification that supports up to 480 Mb/s connection speed.

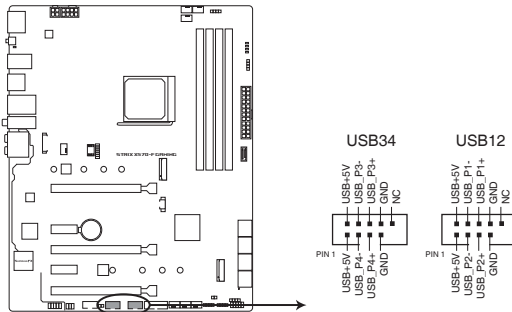

**ROG STRIX X570-F GAMING USB2.0 connectors**



Never connect a 1394 cable to the USB connectors. Doing so will damage the motherboard!

## 6. LED connector (13-pin LED1\_CON1)

This connector is for connecting the LED strip on your back I/O cover.

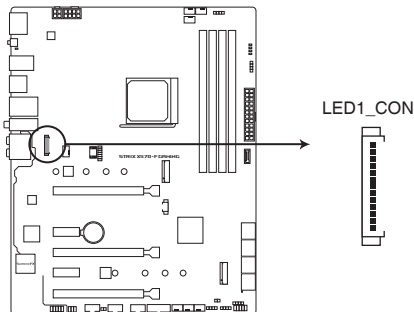

**ROG STRIX X570-F GAMING LED\_CON**

## 7. System panel connectors (10-1 pin F\_PANEL; 4-pin SPEAKER)

These connectors supports several chassis-mounted functions.

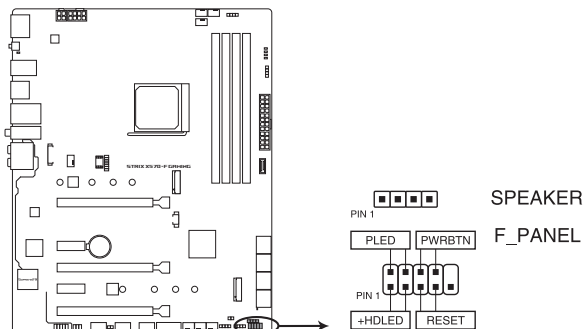

**ROG STRIX X570-F GAMING System panel connector**

- **System power LED (2-pin PLED)**

This 2-pin connector is for the system power LED. Connect the chassis power LED cable to this connector. The system power LED lights up when you turn on the system power, and blinks when the system is in sleep mode.

- **Hard disk drive activity LED (2-pin +HDLED\_LED)**

This 2-pin connector is for the HDD Activity LED. Connect the HDD Activity LED cable to this connector. The HDD LED lights up or flashes when data is read from or written to the HDD.

- **System warning speaker (4-pin SPEAKER)**

This 4-pin connector is for the chassis-mounted system warning speaker. The speaker allows you to hear system beeps and warnings.

- **ATX power button/soft-off button (2-pin PWRBTN)**

This connector is for the system power button. Pressing the power button turns the system on or puts the system in sleep or soft-off mode depending on the BIOS settings. Pressing the power button for more than four seconds while the system is ON turns the system OFF.

- **Reset button (2-pin RESET)**

This 2-pin connector is for the chassis-mounted reset button for system reboot without turning off the system power.

## 8. CPU, CPU optional, and chassis fan connectors; M.2 fan connector, water pump+, and AIO pump connectors (4-pin CPU\_FAN, 4-pin CPU\_OPT, 4-pin CHA\_FAN1-3; 4-pin M.2\_FAN, 4-pin W\_PUMP+, 4-pin AIO\_PUMP)

Connect the fan cables to the fan connectors on the motherboard, ensuring that the black wire of each cable matches the ground pin of the connector.

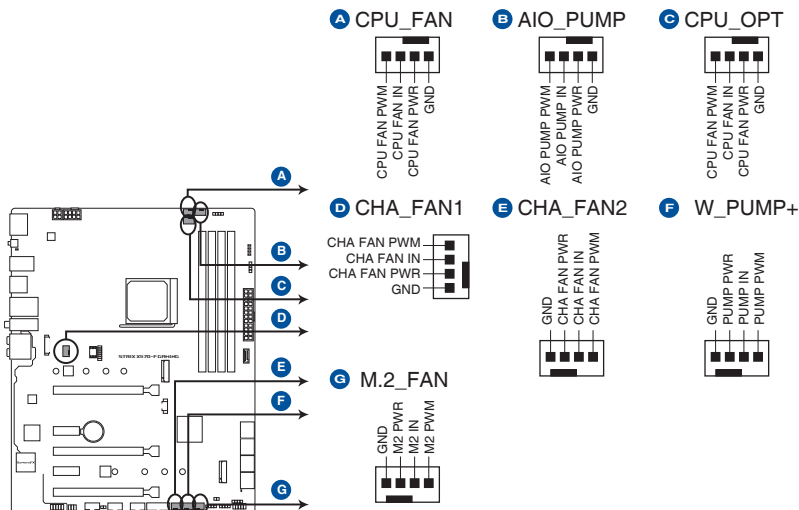

**ROG STRIX X570-F GAMING Fan connectors**



- DO NOT forget to connect the fan cables to the fan connectors. Insufficient air flow inside the system may damage the motherboard components. These are not jumpers! Do not place jumper caps on the fan connectors!
- Ensure to fully insert the 4-pin CPU fan cable to the CPU fan connector.



- Connect the pump cable from the all-in-one cooler (AIO cooler) to the AIO\_PUMP header, and connect the fan cables to the CPU\_FAN and/or CPU\_OPT header(s).
- W\_PUMP+ function support depends on water cooling device.

Header	Max. Current	Max. Power	Default Speed	Shared Control
CPU_FAN	1A	12W	Q-Fan Controlled	A
CPU_OPT	1A	12W	Q-Fan Controlled	A
CHA_FAN1	1A	12W	Q-Fan Controlled	-
CHA_FAN2	1A	12W	Q-Fan Controlled	-
AIO_PUMP	1A	12W	Full Speed	-
W_PUMP+	3A	36W	Full Speed	-
M.2_FAN	1A	12W	Q-Fan Controlled	-

## 9. ATX power connectors (24-pin EATXPWR; 8-pin EATX12V\_1; 4-pin EATX12V\_2)

These connectors are for ATX power supply plugs. The power supply plugs are designed to fit these connectors in only one orientation. Find the proper orientation and push down firmly until the connectors completely fit.

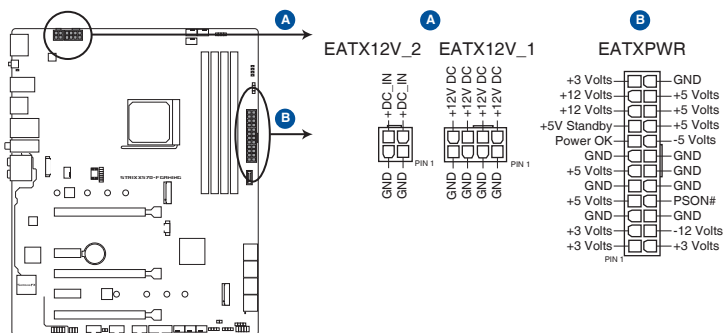

### ROG STRIX X570-F GAMING power connectors



- DO NOT connect the 4-pin power plug only, the motherboard may overheat under heavy usage.
- Ensure to connect the 8-pin power plug, or connect both the 8-pin and 4-pin power plugs.



- For a fully configured system, we recommend that you use a power supply unit (PSU) that complies with ATX 12 V Specification 2.0 (or later version) and provides a minimum power of 350 W.
- We recommend that you use a PSU with a higher power output when configuring a system with more power-consuming devices. The system may become unstable or may not boot up if the power is inadequate.
- If you want to use two or more high-end PCIe x16 cards, use a PSU with 1000W power or above to ensure the system stability.



## 10. M.2 sockets (M.2\_1; M.2\_2)

These sockets allow you to install M.2 SSD modules.

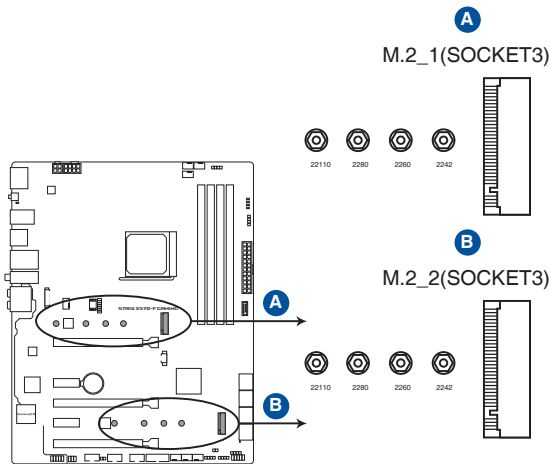

**ROG STRIX X570-F GAMING M.2 sockets**



- For 3<sup>rd</sup> Generation AMD Ryzen™ processors, the M.2 socket 3 supports PCIe 4.0 x4 mode and SATA mode M Key design and type 2242 / 2260 / 2280 / 22110 storage devices.
- For 2<sup>nd</sup> Generation AMD Ryzen™ / 2<sup>nd</sup> and 1<sup>st</sup> Generation AMD Ryzen™ with Radeon™ Vega Graphics processors, the M.2 socket 3 supports PCIe 3.0 x4 mode and SATA mode M Key design and type 2242 / 2260 / 2280 / 22110 storage devices.
- For AMD X570 chipset, the M.2 socket 3 supports PCIe 4.0 x4 mode and SATA mode M Key design and type 2242/ 2260/ 2280 / 22110 storage devices.



The M.2 SSD module is purchased separately.

## 11. SPI TPM connector (14-1 pin SPI\_TPM)

This connector supports a Trusted Platform Module (TPM) system, which securely stores keys, digital certificates, passwords and data. A TPM system also helps enhance network security, protect digital identities, and ensures platform integrity.

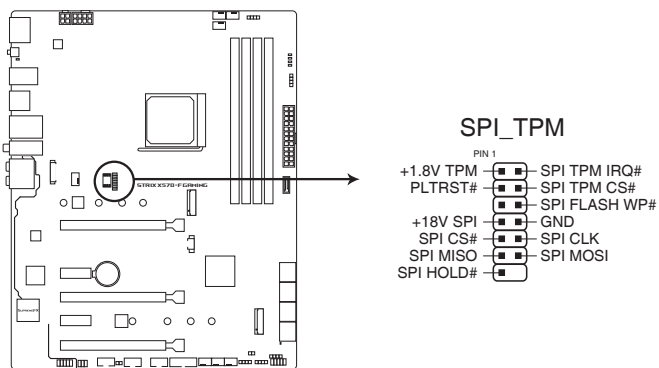

**ROG STRIX X570-F GAMING SPI TPM connector**



The SPI TPM module is purchased separately.

## 12. NODE connector (12-1 pin NODE)

This connector allows you to connect a compatible PSU or control a compatible fan extension card.

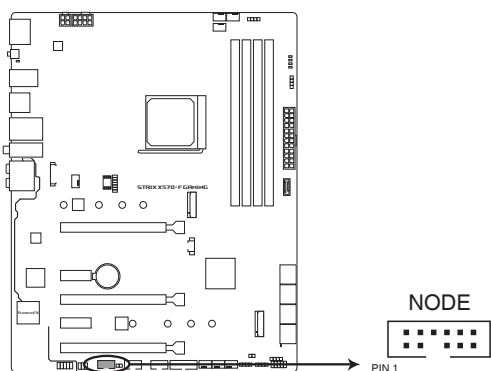

**ROG STRIX X570-F GAMING Node connector**

### 13. PCH fan connector (4 pin PCH\_FAN)

The PCH Fan connector is for connecting the PCH fan on your PCH cover.

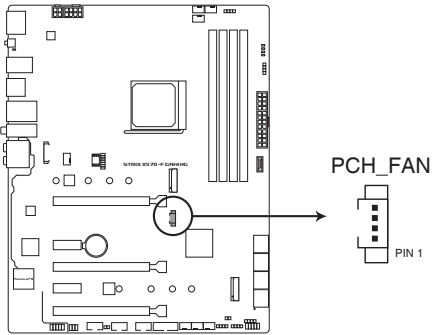

**ROG STRIX X570-F GAMING PCH FAN header**



# Basic Installation

# 2

## 2.1 Building your PC system



The diagrams in this section are for reference only. The motherboard layout may vary with models, but the installation steps are the same for all models.

### 2.1.1 Motherboard installation

1. Place the motherboard into the chassis, ensuring that its rear I/O ports are aligned to the chassis' rear I/O panel.

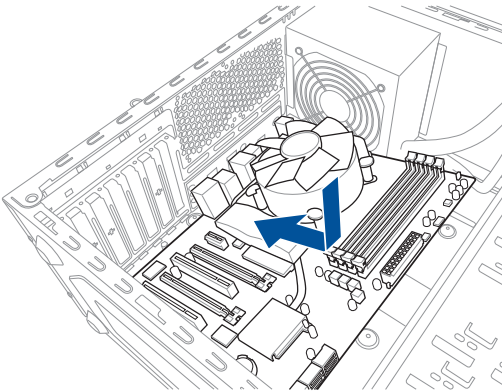

2. Remove the screws that secure the PCH cover (A), then remove the PCH cover (B).

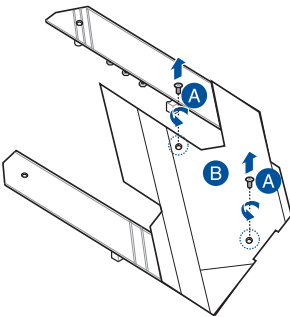

3. Remove the screws that secure the M.2 heatsink (A), then remove the M.2 heatsink (B).

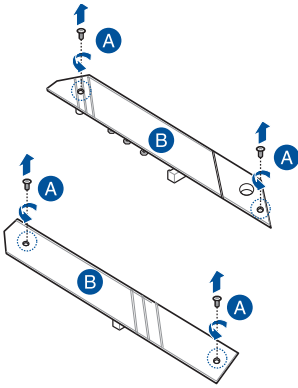

4. Place nine (9) screws into the holes indicated by circles to secure the motherboard to the chassis.

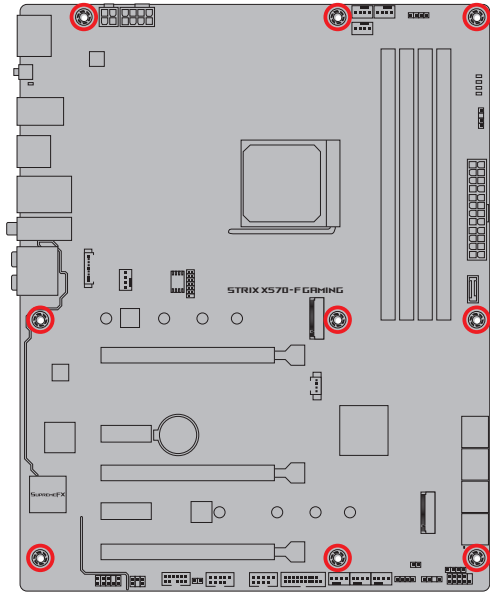
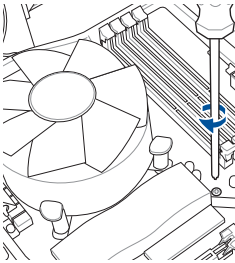

DO NOT over tighten the screws! Doing so can damage the motherboard.

## 2.1.2 CPU installation



The AMD AM4 socket is compatible with AMD AM4 processors. Ensure you use a CPU designed for the AM4 socket. The CPU fits in only one correct orientation. **DO NOT** force the CPU into the socket to prevent bending the connectors on the socket and damaging the CPU!

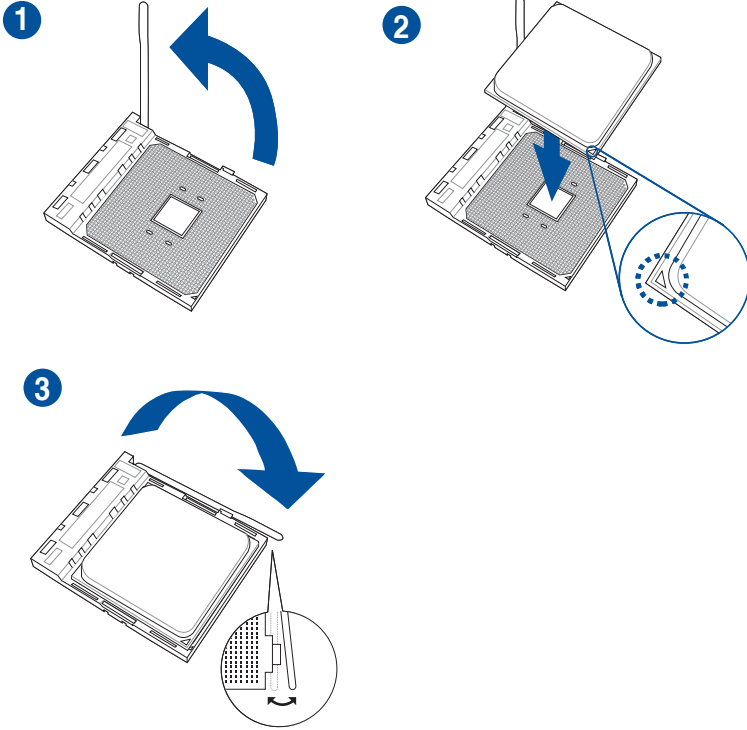

## 2.1.3 CPU heatsink and fan assembly installation



Apply the Thermal Interface Material to the CPU heatsink and CPU before you install the heatsink and fan if necessary.

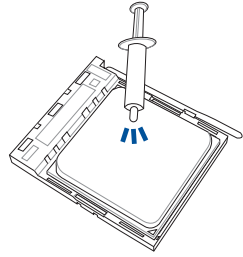

### CPU Heatsink and fan assembly Type 1

1

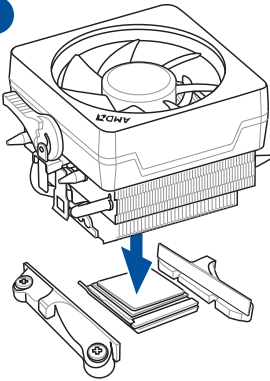

2

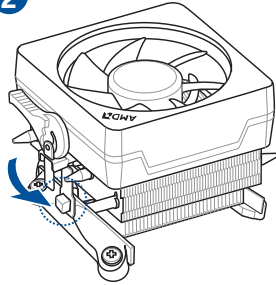

3

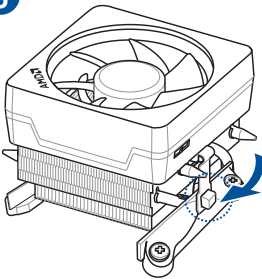

4

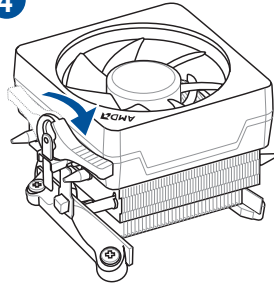

5

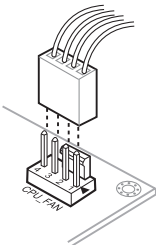



## CPU Heatsink and fan assembly Type 2

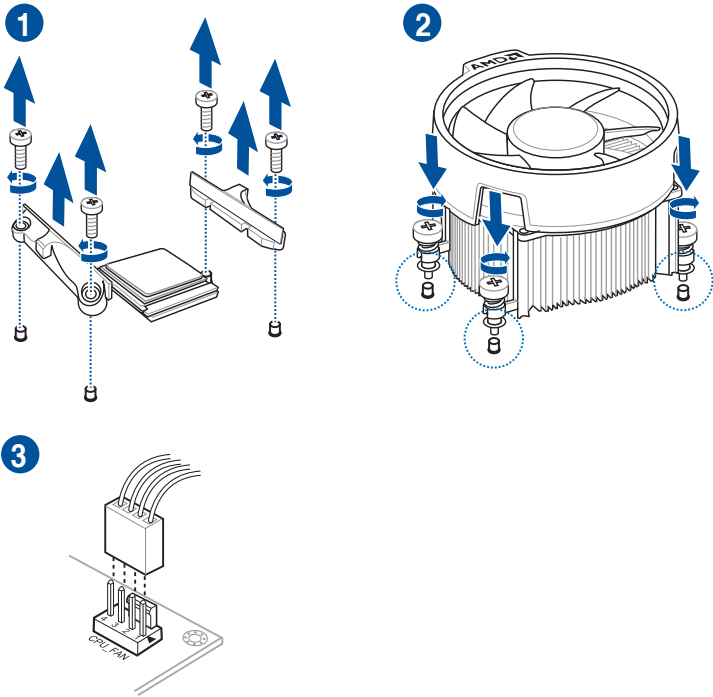

When using this type of CPU fan, remove the screws and the retention module only. Do not remove the plate on the bottom.

## To install an AIO cooler

1

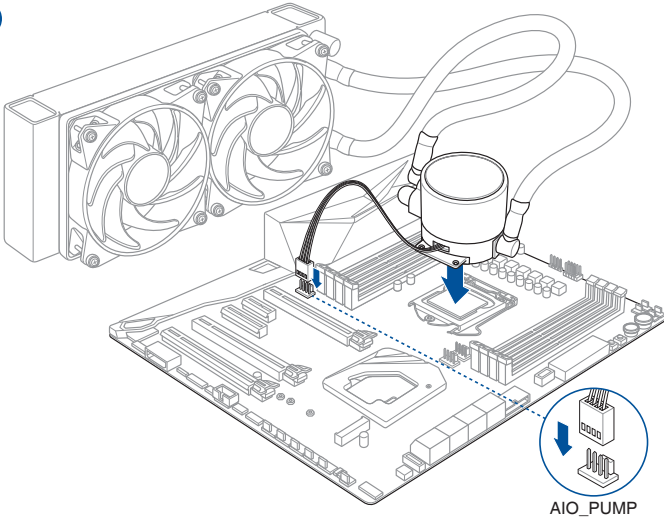

2

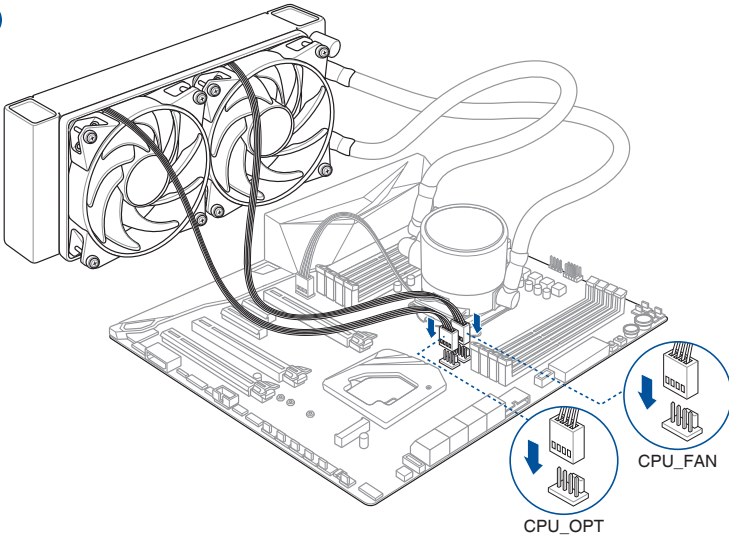

## 2.1.4 DIMM installation

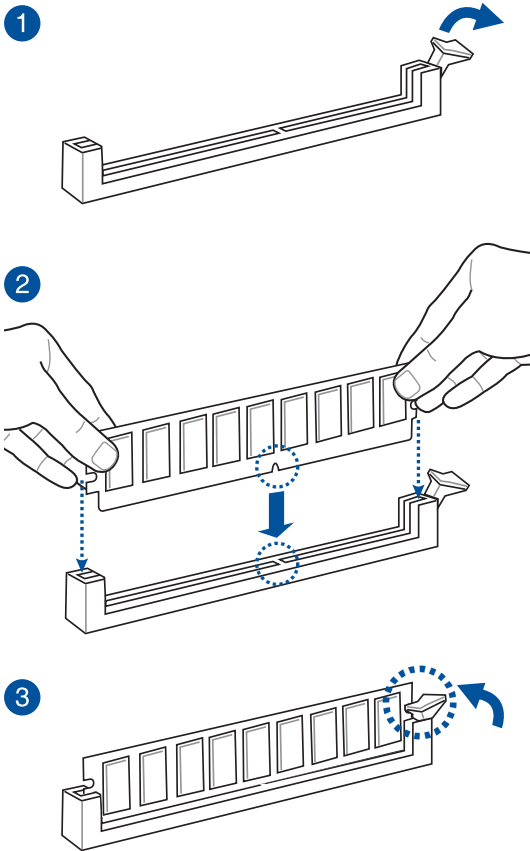

To remove a DIMM

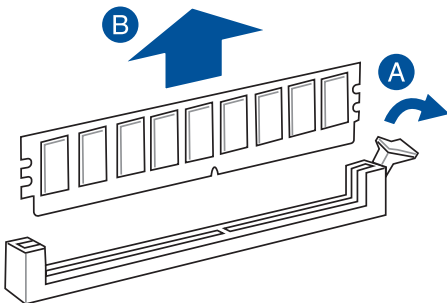

## 2.1.5 ATX power connection

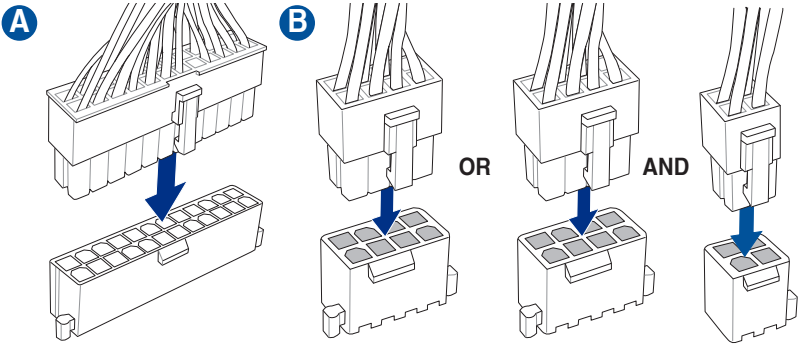

- DO NOT connect the 4-pin power plug only, the motherboard may overheat under heavy usage.
- Ensure to connect the 8-pin power plug, or connect both the 8-pin and 4-pin power plugs.

## 2.1.6 SATA device connection

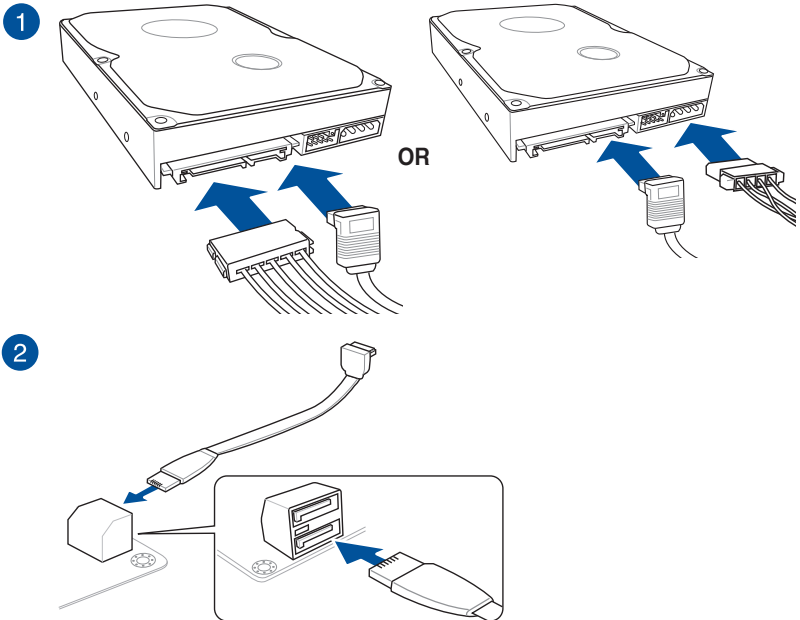

## 2.1.7 Front I/O connector

To install the front panel connector

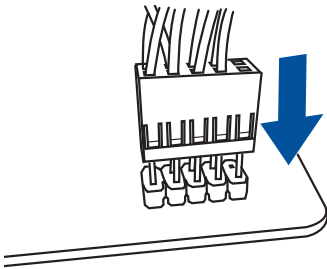

To install USB 3.2 Gen2 connector

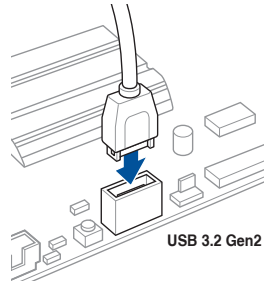

This connector will only fit in one orientation. Push the connector until it clicks into place.

To install USB 2.0 connector

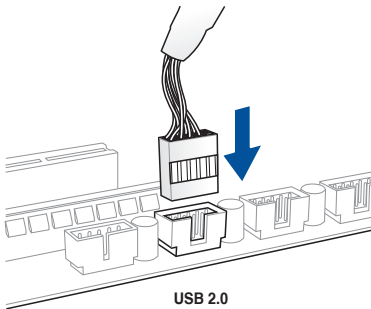

To install front panel audio connector

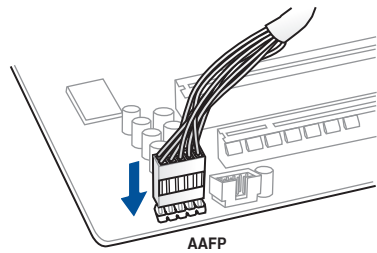

To install system speaker connector

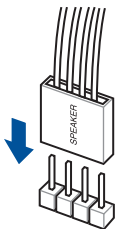

## 2.1.8 Expansion card installation

To install PCIe x16 cards

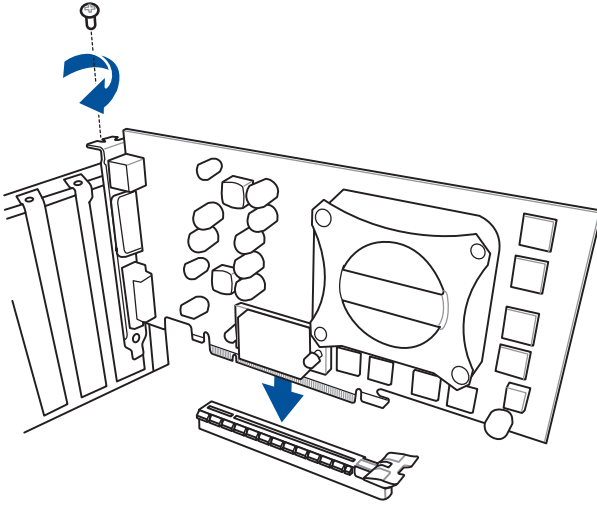

To install PCIe x1 cards

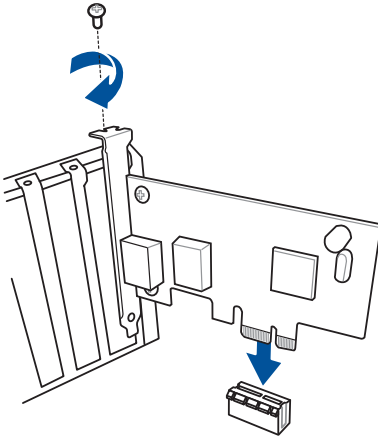

## 2.1.9 M.2 installation



Supported M.2 type varies per motherboard.

### M.2 installation

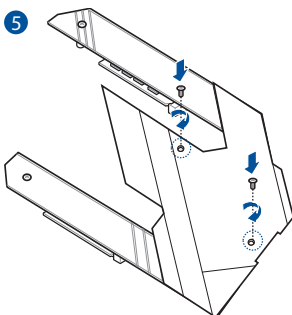
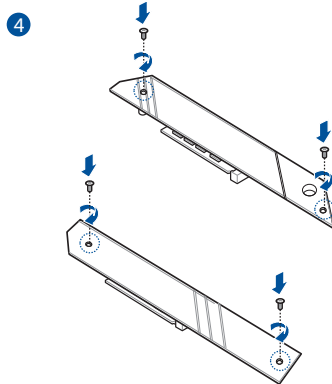
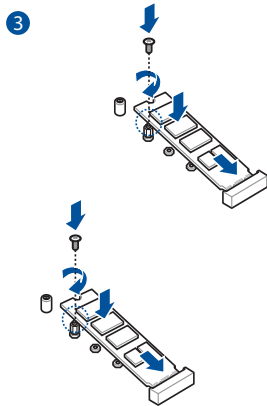
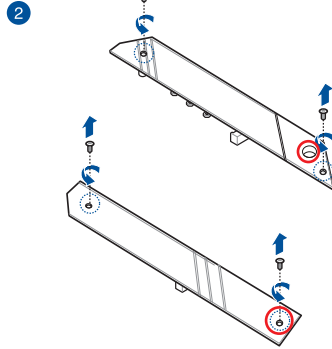
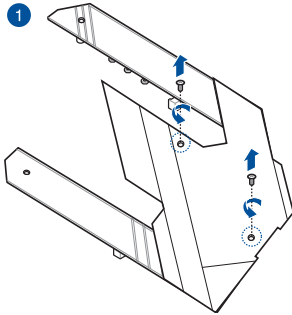

Before securing the motherboard to the chassis, please remove the PCH cover first and then the M.2 heatsink.

## 2.2 BIOS update utility

### USB BIOS Flashback

USB BIOS Flashback allows you to easily update the BIOS without entering the existing BIOS or operating system. Simply insert a USB storage device to the USB port, press the USB BIOS Flashback button for three seconds, and the BIOS is updated automatically.

#### To use USB BIOS Flashback:

1. Insert a USB storage device to the USB Flashback port.



---

We recommend you to use a USB 2.0 storage device to save the latest BIOS version for better compatibility and stability.

---

2. Visit <https://www.asus.com/support/> and download the latest BIOS version for this motherboard.
3. Rename the file as **SX570FG.CAP**, then copy it to your USB storage device.
4. Shut down your computer.
5. Press the BIOS Flashback button for three seconds until the Flashback LED blinks three times, indicating that the BIOS Flashback function is enabled.

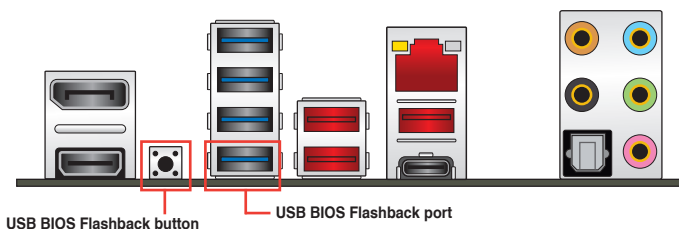

6. Wait until the light goes out, indicating that the BIOS updating process is completed.



---

For more BIOS update utilities in BIOS setup, refer to the section **Updating BIOS** in Chapter 3.

---



- Do not unplug portable disk or power system while BIOS update is ongoing, otherwise update will be interrupted. In case of interruption, please follow the steps again.
  - If the light flashes for five seconds and turns into a solid light, this means that the BIOS Flashback is not operating properly. This may be caused by improper installation of the USB storage device and filename/file format error. If this scenario happens, please restart the system to turn off the light.
  - Updating BIOS may have risks. If the BIOS program is damaged during the process and results to the system's failure to boot up, please contact your local ASUS Service Center.
-



## 2.3 Motherboard rear and audio connections

### 2.3.1 Rear I/O connection

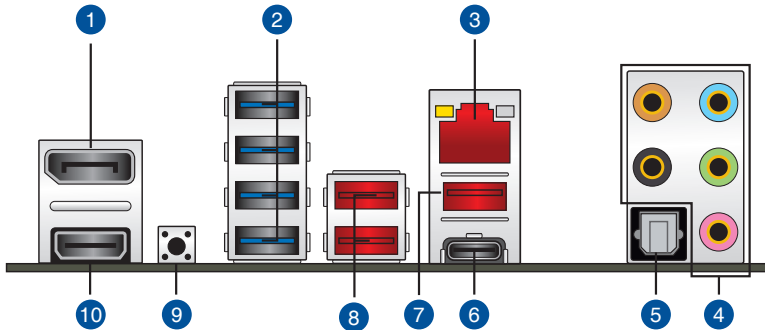

#### Rear panel connectors

1.	DisplayPort
2.	USB 3.2 Gen1 ports 7~10
3.	LAN (RJ-45) port*
4.	Audio I/O ports**
5.	Optical S/PDIF OUT port
6.	USB 3.2 Gen2 Type-C™ port C4
7.	USB 3.2 Gen2 port 3
8.	USB 3.2 Gen2 ports 5 and 6
9.	USB BIOS Flashback™ button
10.	HDMI port

\* and \*\*: Refer to the tables on the next page for LAN port LEDs, and audio port definitions.



- USB 3.2 Gen2 / Gen1 devices can only be used for data storage.
- We strongly recommend that you connect your devices to ports with matching data transfer rate. Please connect your USB 3.2 Gen2 devices to USB 3.2 Gen2 ports and your USB 3.2 Gen1 devices to USB 3.2 Gen1 ports for faster and better performance for your devices.

**\* LAN port LED indications**

Activity Link LED		Speed LED	
Status	Description	Status	Description
OFF	No link	OFF	10 Mbps connection
ORANGE	Linked	ORANGE	100 Mbps connection
BLINKING	Data activity	GREEN	1 Gbps connection

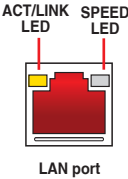

**\*\* Audio 2, 4, 5.1 or 7.1-channel configuration**

Port	Headset 2-channel	4-channel	5.1-channel	7.1-channel
Light Blue	Line In	Line In	Line In	Side Speaker Out
Lime	Line Out	Front Speaker Out	Front Speaker Out	Front Speaker Out
Pink	Mic In	Mic In	Mic In	Mic In
Orange	–	–	Center/Sub woofer	Center/Sub woofer
Black	–	Rear Speaker Out	Rear Speaker Out	Rear Speaker Out

## 2.3.2 Audio I/O connections

### Audio I/O ports

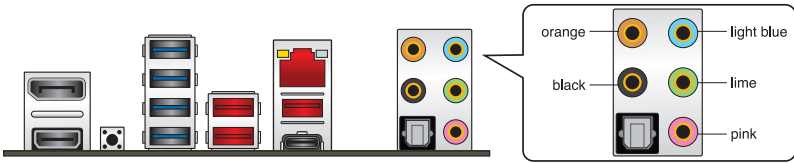

### Connect to Headphone and Mic



### Connect to Stereo Speakers

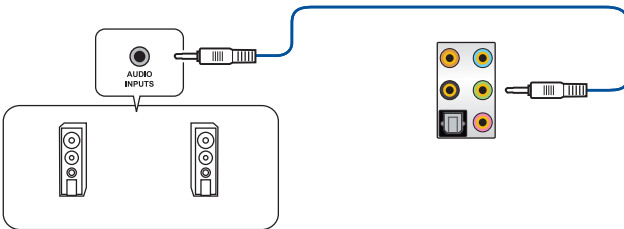

### Connect to 2-channel Speakers

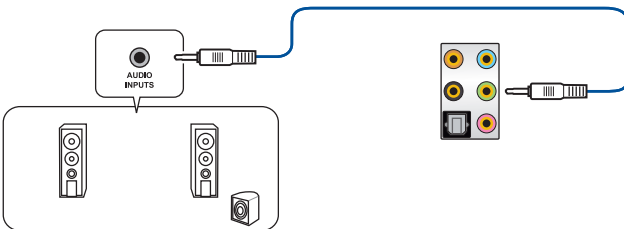

## Connect to 4-channel Speakers

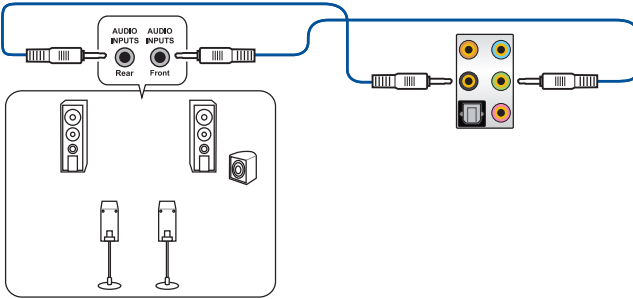

## Connect to 5.1-channel Speakers

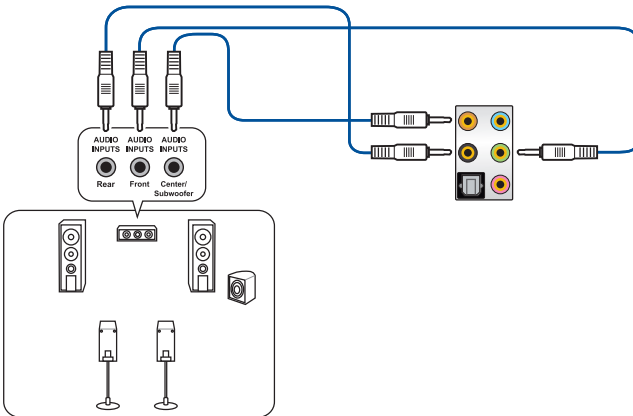

## Connect to 7.1-channel Speakers

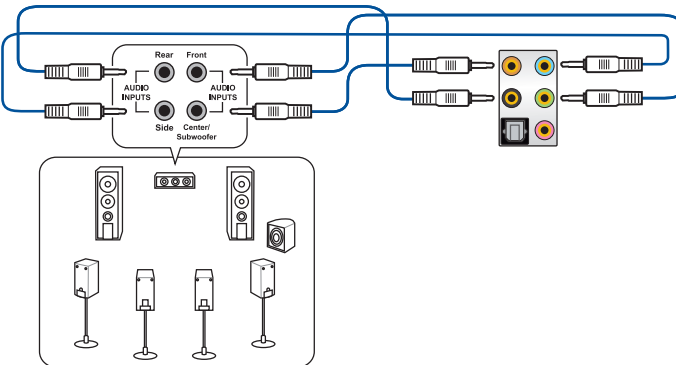

## 2.3 Starting up for the first time

1. After making all the connections, replace the system case cover.
2. Ensure that all switches are off.
3. Connect the power cord to the power connector at the back of the system chassis.
4. Connect the power cord to a power outlet that is equipped with a surge protector.
5. Turn on the devices in the following order:
  - a. Monitor
  - b. External SCSI devices (starting with the last device on the chain)
  - c. System power
6. After applying power, the system power LED on the system front panel case lights up. For systems with ATX power supplies, the system LED lights up when you press the ATX power button. If your monitor complies with the “green” standards or if it has a “power standby” feature, the monitor LED may light up or change from orange to green after the system LED turns on.

The system then runs the power-on self tests (POST). While the tests are running, the BIOS beeps (refer to the BIOS beep codes table) or additional messages appear on the screen. If you do not see anything within 30 seconds from the time you turned on the power, the system may have failed a power-on test. Check the jumper settings and connections or call your retailer for assistance.

BIOS Beep	Description
One short beep	VGA detected Quick boot set to disabled No keyboard detected
One continuous beep followed by two short beeps then a pause (repeated)	No memory detected
One continuous beep followed by three short beeps	No VGA detected
One continuous beep followed by four short beeps	Hardware component failure

7. At power on, hold down the <Delete> key to enter the BIOS Setup. Follow the instructions in Chapter 3.

## 2.4 Turning off the computer

While the system is ON, press the power button for less than four seconds to put the system on sleep mode or soft-off mode, depending on the BIOS setting. Press the power button for more than four seconds to let the system enter the soft-off mode regardless of the BIOS setting.



# BIOS Setup

# 3

## 3.1 Knowing BIOS

---



The new ASUS UEFI BIOS is a Unified Extensible Interface that complies with UEFI architecture, offering a user-friendly interface that goes beyond the traditional keyboard-only BIOS controls to enable a more flexible and convenient mouse input. You can easily navigate the new UEFI BIOS with the same smoothness as your operating system. The term “BIOS” in this user manual refers to “UEFI BIOS” unless otherwise specified.

---

BIOS (Basic Input and Output System) stores system hardware settings such as storage device configuration, overclocking settings, advanced power management, and boot device configuration that are needed for system startup in the motherboard CMOS. In normal circumstances, the default BIOS settings apply to most conditions to ensure optimal performance. **DO NOT change the default BIOS settings** except in the following circumstances:

- An error message appears on the screen during the system bootup and requests you to run the BIOS Setup.
- You have installed a new system component that requires further BIOS settings or update.



Inappropriate BIOS settings may result to instability or boot failure. **We strongly recommend that you change the BIOS settings only with the help of a trained service personnel.**

---



When downloading or updating the BIOS file, rename it as **SX570FG.CAP** for this motherboard.

---

## 3.2 BIOS setup program

Use the BIOS Setup to update the BIOS or configure its parameters. The BIOS screen include navigation keys and brief onscreen help to guide you in using the BIOS Setup program.

### Entering BIOS at startup

To enter BIOS Setup at startup, press <Delete> or <F2> during the Power-On Self Test (POST). If you do not press <Delete> or <F2>, POST continues with its routines.

### Entering BIOS Setup after POST

To enter BIOS Setup after POST:

- Press <Ctrl>+<Alt>+<Delete> simultaneously.
- Press the reset button on the system chassis.
- Press the power button to turn the system off then back on. Do this option only if you failed to enter BIOS Setup using the first two options.

After doing either of the three options, press <Delete> key to enter BIOS.



- 
- The BIOS setup screens shown in this section are for reference purposes only, and may not exactly match what you see on your screen.
  - Ensure that a USB mouse is connected to your motherboard if you want to use the mouse to control the BIOS setup program.
  - If the system becomes unstable after changing any BIOS setting, load the default settings to ensure system compatibility and stability. Select the **Load Optimized Defaults** item under the **Exit** menu or press hotkey <F5>. See section 3.10 **Exit Menu** for details.
  - If the system fails to boot after changing any BIOS setting, try to clear the CMOS and reset the motherboard to the default value. See section 1.1.7 **Headers** for information on how to erase the RTC RAM via the Clear CMOS button.
  - The BIOS setup program does not support the Bluetooth devices.
- 



---

Please visit ASUS website for the detailed BIOS content manual.

---

### BIOS menu screen

The BIOS Setup program can be used under two modes: **EZ Mode** and **Advanced Mode**. You can change modes from **Setup Mode** in **Boot menu** or by pressing the <F7> hotkey.



### 3.2.1 Advanced Mode

By default, the Advanced Mode screen appears when you enter the BIOS setup program. The Advanced Mode provides advanced options for experienced end-users to configure the BIOS settings. The figure below shows an example of the Advanced Mode. Refer to the following sections for the detailed configurations. To access the EZ Mode, click **EzMode(F7)** or press <F7>.



The default screen for entering the BIOS setup program can be changed. Refer to the **Setup Mode** item in section **Boot menu** for details.

The screenshot shows the BIOS Advanced Mode interface with the following components labeled:

- Menu items:** Language, MyFavorite(F3), Qfan Control(F6), Search(F9), AURA ON/OFF(F4), Scroll bar.
- Menu bar:** My Favorites, Main, Ai Tweaker, Advanced, Monitor, Boot, Tool, Exit.
- Submenu items:** AI Overclock Tuner, Memory Frequency, Custom CPU Core Ratio, > CPU Core Ratio, EPU Power Saving Mode, TPU, Performance Bias, > DRAM Timing Control, > DIGI+ VRM, VDDCR CPU Voltage.
- Configuration fields:** Target CPU Speed : 3400MHz, Target DRAM Frequency : 2133MHz, VDDCR CPU Voltage (1.100V).
- Pop-up Menu:** Auto, Auto, Auto, Auto, Disabled, Keep Current Settings, Auto, None, CB15, Aida/Geekbench, CB11.5.
- Hardware Monitor:** CPU (Frequency: 3400 MHz, Temperature: 51°C, APU Freq: 100.0 MHz, Core Voltage: 1.224 V, Ratio: 34x), Memory (Frequency: 2133 MHz, Capacity: 8192 MB), Voltage (+12V: +5V, 11.980 V, 5.060 V; +3.3V: 3.232 V).
- General help:** Different Values may help different Software's performance.
- Last modified settings:** Last Modified, EzMode(F7) [-], Hot Keys [7], Search on FAQ.
- Go back to EZ Mode:** EzMode(F7) [-].
- Hot Keys:** Hot Keys [7].
- Search on the FAQ:** Search on FAQ.

## Menu bar

The menu bar on top of the screen has the following main items:

<b>My Favorites</b>	For saving the frequently-used system settings and configuration.
<b>Main</b>	For changing the basic system configuration
<b>Ai Tweaker</b>	For changing the overclocking settings
<b>Advanced</b>	For changing the advanced system settings
<b>Monitor</b>	For displaying the system temperature, power status, and changing the fan settings.
<b>Boot</b>	For changing the system boot configuration
<b>Tool</b>	For configuring options for special functions
<b>Exit</b>	For selecting the exit options and loading default settings

## Menu items

The highlighted item on the menu bar displays the specific items for that menu. For example, selecting **Main** shows the Main menu items.

The other items (My Favorites, Ai Tweaker, Advanced, Monitor, Boot, Tool, and Exit) on the menu bar have their respective menu items.

## Submenu items

A greater than sign (>) before each item on any menu screen means that the item has a submenu. To display the submenu, select the item and press <Enter>.

## Language

This button above the menu bar contains the languages that you can select for your BIOS. Click this button to select the language that you want to display in your BIOS screen.

## My Favorites(F3)

This button above the menu bar shows all BIOS items in a Tree Map setup. Select frequently-used BIOS settings and save it to MyFavorites menu.



---

Refer to section **3.3 My Favorites** for more information.

---

## Q-Fan Control(F6)

This button above the menu bar displays the current settings of your fans. Use this button to manually tweak the fans to your desired settings.



---

Refer to section **3.2.3 QFan Control** for more information.

---

## EZ Tuning Wizard(F11)

This button above the menu bar allows you to view and tweak the overclocking settings of your system.



---

Refer to section **3.2.4 EZ Tuning Wizard** for more information.

---

## Search (F9)

This button allows you to search by BIOS item name, enter the item name to find the related item listing.

## AURA (F4)

This button allows you to turn the RGB LED lighting on or off.

[All On] All AURA effects will be enabled. (Default mode)

[Stealth Mode] All LEDs (Aura and Functional) will be disabled.

[Aura Only] AURA LEDs will be enabled and functional LEDs will be disabled.

[Aura Off] AURA LEDs will be disabled and functional LEDs will be enabled.

## Search on FAQ

Move your mouse over this button to show a QR code, scan this QR code on your mobile device to connect to the BIOS FAQ web page of the ASUS support website. You can also scan the following QR code:



## Hot keys

This button above the menu bar contains the navigation keys for the BIOS setup program. Use the navigation keys to select items in the menu and change the settings.

## Scroll bar

A scroll bar appears on the right side of a menu screen when there are items that do not fit on the screen. Press the Up/Down arrow keys or <Page Up> / <Page Down> keys to display the other items on the screen.

## General help

At the bottom of the menu screen is a brief description of the selected item. Use <F12> key to capture the BIOS screen and save it to the removable storage device.

## Configuration fields

These fields show the values for the menu items. If an item is user-configurable, you can change the value of the field opposite the item. You cannot select an item that is not user-configurable.

A configurable field is highlighted when selected. To change the value of a field, select it and press <Enter> to display a list of options.

## Last Modified button

This button shows the items that you last modified and saved in BIOS Setup.

### 3.2.2 EZ Mode

The EZ Mode provides you an overview of the basic system information, and allows you to select the display language, system performance, mode and boot device priority.



To switch from Advanced Mode to EZ Mode, click **EZ Mode(F7)** or press the <F7> hotkey.

Displays the CPU/motherboard temperature, CPU voltage output, CPU/chassis fan speed, and SATA information

Displays the system properties of the selected mode. Click < > to switch EZ System Tuning modes

Selects the display language of the BIOS setup program

Creates storage RAID and configures system overclocking

Searches by BIOS item name, enter the item name to find the related item listing

Turns the RGB LED lighting or functional LED on or off

Displays the CPU Fan's speed. Click the button to manually tune the fans

Saves the changes and resets the system

Loads optimized default settings

Click to go to Advanced mode

Search on the FAQ

Click to display boot devices

Selects the boot device priority



The boot device options vary depending on the devices you installed to the system.

### 3.2.3 Q-Fan Control

The QFan Control allows you to set a fan profile or manually configure the operating speed of your CPU and chassis fans.

The screenshot shows the Q-Fan Control interface. At the top, there is a title "Q-Fan Control" and a descriptive paragraph: "Select your target fan and then move the slider to select any of these profiles: Standard, Silent, Turbo and Full Speed). You can also move the slider to Manual and manually configure the fan's operating speed." Below this, there are two tabs: "PWM" and "DC". A line graph shows fan speed (%) on the y-axis (0 to 100) and temperature (°C) on the x-axis (0 to 100). The graph shows a yellow line that starts at 50% at 0°C, remains constant until 30°C, then rises to 100% at 70°C, and remains constant until 100°C. Below the graph, there are five radio buttons for fan profiles: "Standard" (selected), "Silent", "Turbo", "Full Speed", and "Manual". At the bottom, there are three buttons: "Undo", "Apply", and "Exit (ESC)".

Annotations with red lines pointing to specific elements:

- Click to select a fan to be configured (points to the fan list)
- Click to activate PWM Mode (points to the PWM tab)
- Click to activate DC Mode (points to the DC tab)
- Select a profile to apply to your fans (points to the Standard radio button)
- Click to apply the fan setting (points to the Apply button)
- Click to go back to main menu (points to the Exit (ESC) button)
- Click to undo the changes (points to the Undo button)
- Select to manually configure your fans (points to the Manual radio button)

## Configuring fans manually

Select **Manual** from the list of profiles to manually configure your fans' operating speed.

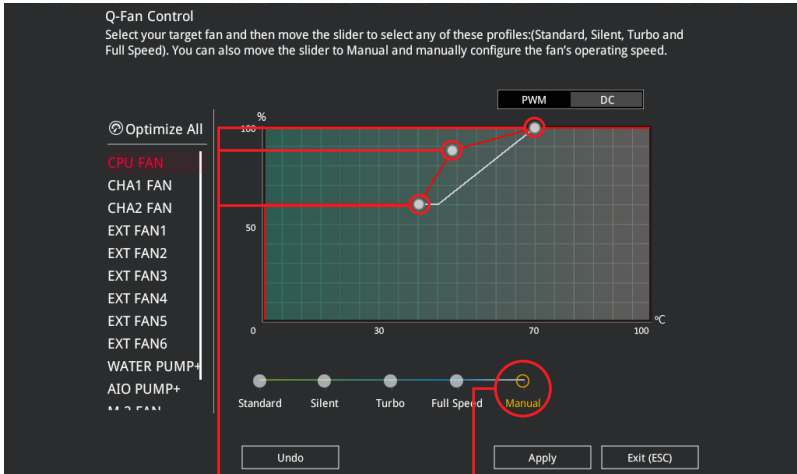

Speed points

Select to manually  
configure your fans

To configure your fans:

1. Select the fan that you want to configure and to view its current status.
2. Click and drag the speed points to adjust the fans' operating speed.
3. Click **Apply** to save the changes then click **Exit (ESC)**.

### 3.2.4 EZ Tuning Wizard

EZ Tuning Wizard allows you to easily overclock your CPU and DRAM, computer usage, and CPU fan to their best settings.

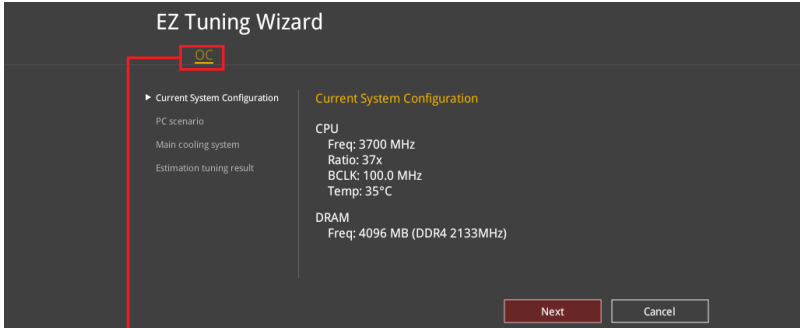

OC setup

### OC Tuning

To start OC Tuning:

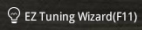
1. Press <F11> on your keyboard or click  from the BIOS screen to open EZ Tuning Wizard screen, and then click **Next**.
2. Select a PC scenario **Daily Computing** or **Gaming/Media Editing**, and then click **Next**.

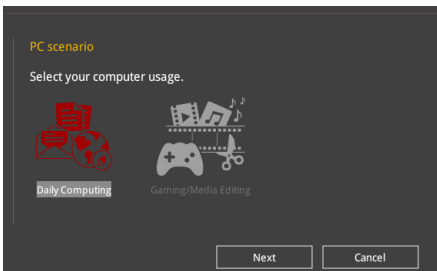

3. Select a Main Cooling System **BOX cooler**, **Tower cooler**, **Water cooler**, or **I'm not sure**, and then click **Next**.

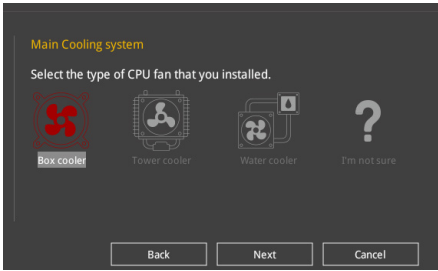

4. After selecting the Main Cooling System, click **Next** then click **Yes** to start the OC Tuning.

### 3.3 My Favorites

My Favorites is your personal space where you can easily save and access your favorite BIOS items.

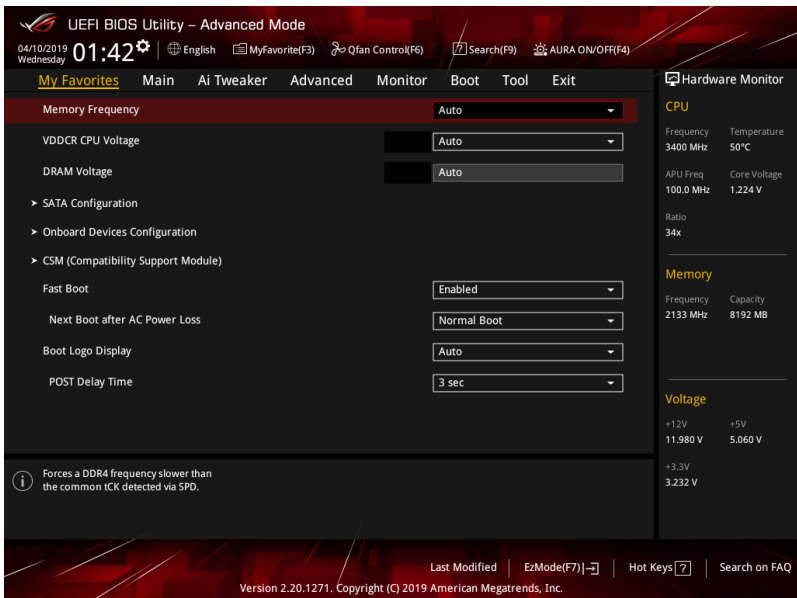

My Favorites comes with several performance, power saving, and fast boot related items by default. You can personalize this screen by adding or removing items.



## Adding items to My Favorites

To add BIOS items:

1. Press <F3> on your keyboard or click  (F3)MyFavorite from the BIOS screen to open Setup Tree Map screen.
2. On the Setup Tree Map screen, select the BIOS items that you want to save in My Favorites screen.

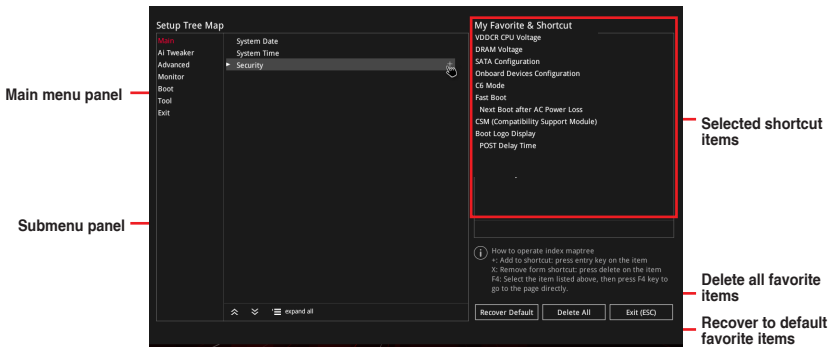

3. Select an item from main menu panel, then click the submenu that you want to save as favorite from the submenu panel and click  or press <Enter> on your keyboard.



You cannot add user-managed items such as language and boot order to My Favorites.

4. Click **Exit (ESC)** or press <Esc> key to close Setup Tree Map screen.
5. Go to My Favorites menu to view the saved BIOS items.

## 3.4 Main menu

The Main menu screen appears when you enter the Advanced Mode of the BIOS Setup program. The Main menu provides you an overview of the basic system information, and allows you to set the system date, time, language, and security settings.

### Security

The Security menu items allow you to change the system security settings.



- If you have forgotten your BIOS password, erase the CMOS Real Time Clock (RTC) RAM to clear the BIOS password. See section 1.1.7 **Headers** for information on how to erase the RTC RAM via the Clear CMOS button.
- The Administrator or User Password items on top of the screen show the default **[Not Installed]**. After you set a password, these items show **[Installed]**.

## 3.5 Ai Tweaker menu

The Ai Tweaker menu items allow you to configure overclocking-related items.



Be cautious when changing the settings of the Ai Tweaker menu items. Incorrect field values can cause the system to malfunction



The configuration options for this section vary depending on the CPU and DIMM model you installed on the motherboard.

### Ai Overclock Tuner

Allows you to select the CPU overclocking options to achieve the desired CPU internal frequency. Configuration options:

- [Auto] Loads the optimal settings for the system.  
[Manual] Allows you to individually set overclocking parameters.



The following item appears only when you set the Ai Overclock Tuner to **[Manual]**.

#### APU Frequency

This item allows you to set the APU frequency to enhance the system performance. Use the <+> or <-> to adjust the value. The values range from 96.0 MHz to 118.0 MHz.

#### Memory Frequency

This item allows you to set the memory operating frequency. The configurable options vary with the BCLK (base clock) frequency setting. Select the auto mode to apply the optimized setting. Configuration options: [Auto] [DDR4-1333MHz] - [DDR4-4200MHz]



Selecting a very high memory frequency may cause the system to become unstable! If this happens, revert to the default setting.

## Custom CPU Core Ratio

This item allows you to set a custom CPU core ratio. The CPU core ratio is calculated with the formula:  $2 * \text{FID}/\text{DID}$ . Configuration options: [Auto] [Manual]



---

The following items appear only when you set the **Custom CPU Core Ratio** to [Manual].

---

### FID

This item allows you to set the core frequency multiplier. Use the <+> or <-> to adjust the value.

### DID

This item allows you to set the core frequency divisor. Use the <+> or <-> to adjust the value.

## EPU Power Saving Mode

The ASUS EPU (Energy Processing Unit) sets the CPU in its minimum power consumption settings. Enable this item to set lower CPU core/cache voltage and achieve the best energy saving condition. Configuration options: [Disabled] [Enabled]

### TPU

This item allows you to automatically overclock the CPU and DRAM frequencies and voltage for an enhanced system performance.

[Keep Current Settings] Keep the current settings without changing anything.

[TPU I] Applies air cooling overclocking conditions.

[TPU II] Applies water cooling overclocking conditions.



---

Ensure to use water cooling device before selecting [TPU II].

---

## 3.6 Advanced menu

The Advanced menu items allow you to change the settings for the CPU and other system devices.



---

Be cautious when changing the settings of the Advanced menu items. Incorrect field values can cause the system to malfunction.

---

### 3.6.1 AMD fTPM Configuration

The items in this menu allow you to configure the AMD fTPM settings.

### 3.6.2 CPU Configuration

The items in this menu show the CPU-related information that the BIOS automatically detects.



---

The items in this menu may vary based on the CPU installed.

---

## PSS Support

This item allows you enable or disable the generation of ACPI\_PPC, \_PSS, and \_PCT objects. Configuration options: [Disabled] [Enabled]

## NX Mode

This item allows you enable or disable no-execute page protection function.

Configuration options: [Disabled] [Enabled]

## SVM Mode

This item allows you enable or disable CPU Virtualization.

Configuration options: [Disabled] [Enabled]

## Core Leveling Mode

This item allows you to change the number of compute unit in the system.

Configuration options: [Automatic mode] [One Computer Unit]

### 3.6.3 Bixby IDE Configuration

The items in this menu allow you to configure Bixby IDE devices.

### 3.6.4 SATA Configuration

While entering Setup, the BIOS automatically detects the presence of SATA devices. The SATA Port items show **Empty** if no SATA device is installed to the corresponding SATA port.

#### SATA 0/1 Enable

This item allows you to enable or disable the SATA Device. Configuration options: [Disabled] [Enabled]

#### SATA Mode

This item allows you to set the SATA configuration.

[AHCI] Set to [AHCI] when you want the SATA hard disk drives to use the AHCI (Advanced Host Controller Interface). The AHCI allows the onboard storage driver to enable advanced Serial ATA features that increases storage performance on random workloads by allowing the drive to internally optimize the order of commands.

[RAID] Set to [RAID] when you want to create a RAID configuration from the SATA hard disk drives.

#### SMART Self Test

S.M.A.R.T. (Self-Monitoring, Analysis and Reporting Technology) is a monitoring system that shows a warning message during POST (Power-on Self Test) when an error occurs in the hard disks. Configuration options: [On] [Off]

#### SATA6G\_1(Gray) - SATA6G\_8(Gray)

##### SATA6G\_1(Gray) - SATA6G\_8(Gray)

This item allows you to enable or disable the selected SATA port. Configuration options: [Disabled] [Enabled]

### Hot Plug

These items appear only when the SATA Mode Selection is set to **[AHCI]** and allows you to enable or disable SATA Hot Plug Support. Configuration options: [Disabled] [Enabled]

## 3.6.5 Onboard Devices Configuration

The items in this menu allow you to switch between PCIe Lanes and configure onboard devices.

### HD Audio Controller

This item allows you to use the Azalia High Definition Audio Controller. Configuration options: [Disabled] [Enabled]

### PCIEX16\_2 Bandwidth

This item allows you to set the PCIEX16\_2 Mode. Configuration options: [X8 Mode] [PCIe RAID Mode]

[X8 Mode] The PCIe x16\_2 slot runs at x8 mode.

[PCIe RAID Mode] The PCIe x16\_2 slot runs at x4 + x4 mode, which allows you to create a RAID array for up to two PCIe devices.



---

Set to **PCIe RAID Mode** when installing a Hyper M.2 x16 card or M.2 adapter cards. Installing other devices when selecting PCIe RAID Mode may cause your PC to fail to boot.

---

### RGB LED lighting

#### When system is in working state

This item allows you to turn the RGB LED lighting on or off when the system is in the working state. Configuration options: [All On] [Stealth] [Aura Only] [Aura Off]

#### When system is in sleep, hibernate or soft off states

This item allows you to turn the RGB LED lighting on or off when the system is in the sleep, hibernate or soft off states. Configuration options: [All On] [Stealth] [Aura Only] [Aura Off]

### Intel LAN Controller

This item allows you to enable or disable the Intel LAN controllers. Configuration options: [On] [Off]

### Intel LAN OPROM

This item allows you to enable or disable the Intel PXE OPROM. Configuration options: [On] [Off]

### USB power delivery in Soft Off state (S5)

This item allows you to enable or disable USB power delivery when the system is at Power State S5. Configuration options: [Disabled] [Enabled]

## 3.6.6 APM Configuration

The items in this menu allow you to set system wake and sleep settings.

### ErP Ready [Disabled]

This item allows you to switch off some power at S4+S5 or S5 to get the system ready for ErP requirement. When set to **[Enabled]**, all other PME options are switched off. Configuration options: [Disabled] [Enable(S4+S5)] [Enable(S5)]

### Restore AC Power Loss

This item allows your system to go to ON state, OFF state, or both states after an AC power loss. When setting your system to [Last State], it goes to the previous state before the AC power loss. Configuration options: [Power Off] [Power On] [Last State]

### Power On By PCI-E

This item allows you to enable or disable the Wake-on-LAN function of the onboard LAN controller or other installed PCI-E LAN cards. Configuration options: [Disabled] [Enabled]

### Power On By RTC

This item allows you to enable or disable the RTC (Real-Time Clock) to generate a wake event and configure the RTC alarm date. When enabled, you can set the days, hours, minutes, or seconds to schedule an RTC alarm date. Configuration options: [Disabled] [Enabled]

## 3.6.7 PCI Subsystem Settings

### SR-IOV Support

This item allows you to enable or disable the Single Root IO Virtualization support if your system has SR-IOV capable PCIe devices. Configuration options: [Disabled] [Enabled]

## 3.6.8 USB Configuration

The items in this menu allow you to change the USB-related features.



---

The **Mass Storage Devices** item shows the auto-detected values. If no USB device is detected, the item shows **None**.

---

### Legacy USB Support

- [Enabled] Your system supports the USB devices in legacy operating systems.
- [Disabled] Your USB devices can be used for BIOS setup only and cannot be recognized in the boot devices list.
- [Auto] Your system automatically detects the presence of USB devices at startup. If any USB devices are detected, the legacy USB support is enabled.

### XHCI Hand-off

- [Enabled] Enables the support for operating systems without an XHCI hand-off feature.
- [Disabled] Disables the XHCI Hand-off support.

## USB Device Enable

This item allows you to enable or disable the USB device. Configuration options: [Disabled] [Enabled]

## USB Single Port Control

This item allows you to enable or disable the individual USB ports.



---

Refer to section 1.1.2 **Motherboard layout** for the location of the USB ports.

---

## 3.6.9 HDD/SSD SMART Information

This menu displays the SMART information of the connected devices.



---

NVM Express devices do not support SMART information.

---

## 3.6.10 NVMe Configuration

The items in this menu allow you to configure the NVMe device options.

## 3.6.11 Network Stack Configuration

The items in this menu allow you to enable or disable the UEFI network stack.

## 3.6.12 AMD CBS

The items in this menu allow you to configure the AMD CBS Setup page.

## 3.7 Monitor menu

The Monitor menu displays the system temperature/power status, and allows you to change the fan settings.

### Q-Fan Configuration

The subitems in this menu allow you to configure the Q-Fan features.

#### Qfan Tuning

Click this item to automatically detect the lowest speed and configure the minimum duty cycle for each fan.

## 3.8 Boot menu

The Boot menu items allow you to change the system boot options.

### Fast Boot

[Disabled]

Allows your system to go back to its normal boot speed.

[Enabled]

Allows your system to accelerate the boot speed.



---

The following items appear only when you set the Fast Boot to **[Enabled]**.

---

### Next Boot after AC Power Loss

[Normal Boot] Returns to normal boot on the next boot after an AC power loss.

[Fast Boot] Accelerates the boot speed on the next boot after an AC power loss.

## CSM (Compatibility Support Module)

This item allows you to configure the CSM (Compatibility Support Module) items to fully support the various VGA, bootable devices and add-on devices for better compatibility.

### Launch CSM

[Enabled] For better compatibility, enable the CSM to fully support the non-UEFI driver add-on devices or the Windows® UEFI mode.

[Disabled] Disable the CSM to fully support the Windows® the Windows secure update and secure boot.



---

The following items appear only when you set the Launch CSM to **[Enabled]**.

---

#### ***Boot Device Control [UEFI and Legacy OPROM]***

This item allows you to select the type of devices that you want to boot. Configuration options: [UEFI and Legacy OPROM] [Legacy OPROM only] [UEFI only]

#### ***Boot from Network Devices [Legacy only]***

This item allows you to select the type of network devices that you want to launch. Configuration options: [Ignore] [Legacy only] [UEFI only]

#### ***Boot from Storage Devices [Legacy only]***

This item allows you to select the type of storage devices that you want to launch. Configuration options: [Ignore] [Legacy only] [UEFI only]

#### ***Boot from PCI-E/PCI Expansion Devices [Legacy only]***

This item allows you to select the type of PCI-E/PCI expansion devices that you want to launch. Configuration options: [Ignore] [Legacy only] [UEFI only]

## Secure Boot

This item allows you to configure the Windows® Secure Boot settings and manage its keys to protect the system from unauthorized access and malwares during POST.

## Boot Option Priorities

These items specify the boot device priority sequence from the available devices. The number of device items that appears on the screen depends on the number of devices installed in the system.



- 
- To access Windows® OS in Safe Mode, press <F8> after POST.
  - To select the boot device during system startup, press <F8> when the ASUS Logo appears.
- 

## Boot Override

These items displays the available devices. The number of device items that appears on the screen depends on the number of devices installed in the system. Click an item to start booting from the selected device.



## 3.9 Tool menu

The Tool menu items allow you to configure options for special functions. Select an item then press <Enter> to display the submenu.

### 3.9.1 ASUS EZ Flash 3 Utility

This item allows you to run ASUS EZ Flash 3. When you press <Enter>, a confirmation message appears. Use the left/right arrow key to select between [Yes] or [No], then press <Enter> to confirm your choice.



For more details, refer to section 3.11.2 ASUS EZ Flash 3.

### 3.9.2 ASUS Secure Erase

SSD speeds may lower over time as with any storage medium due to data processing. Secure Erase completely and safely cleans your SSD, restoring it to factory performance levels.

To launch ASUS Secure Erase, click **Tool > ASUS Secure Erase** on the Advanced mode menu.



Check the ASUS support site for a full list of SSDs tested with ASUS Secure Erase. The drive may become unstable if you run ASUS Secure Erase on an incompatible SSD.



The time to erase the contents of your SSD may take a while depending on its size. Do not turn off the system during the process.

Displays the available SSDs

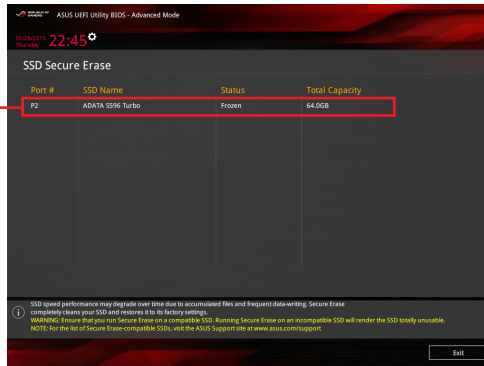



---

**Status definition:**

- **Frozen.** The frozen state is the result of a BIOS protective measure. The BIOS guards drives that do not have password protection by freezing them prior to booting. If the drive is frozen, a power off or hard reset of your PC must be performed to proceed with the ASUS Secure Erase.
  - **Locked.** SSDs might be locked if the Secure Erase process is either incomplete or was stopped. This may be due to a third party software that uses a different password defined by ASUS. You have to unlock the SSD in the software before proceeding with ASUS Secure Erase.
- 

### 3.9.3 ASUS User profile

This item allows you to store or load multiple BIOS settings.

#### Load from Profile

This item allows you to load the previous BIOS settings saved in the BIOS Flash. Key in the profile number that saved your BIOS settings, press <Enter>, and then select **Yes**.



- DO NOT shut down or reset the system while updating the BIOS to prevent the system boot failure!
  - We recommend that you update the BIOS file only coming from the same memory/CPU configuration and BIOS version.
- 

#### Profile Name

This item allows you to key in a profile name.

#### Save to Profile

This item allows you to save the current BIOS settings to the BIOS Flash, and create a profile. Key in a profile number from one to eight, press <Enter>, and then select **Yes**.

#### Load/Save Profile from/to USB Drive

This item allows you to load or save profile from your USB drive, load and save profile to your USB drive.

### 3.9.4 ASUS SPD Information

This item allows you to view the DRAM SPD information.

### 3.9.5 Graphics Card Information

This item displays the information about the graphics card installed in your system.

#### GPU Post

This item displays the information and recommended configuration for the PCIE slots that the graphics card is installed in your system.



---

This feature is only supported on selected ASUS graphics cards.

---

### 3.9.6 ASUS Armoury Crate

This item allows you to enable Armoury Crate download process. Armoury Crate app can help you manage and download the latest ROG drivers and utilities updates for your motherboard.

## 3.10 Exit menu

The Exit menu items allow you to load the optimal default values for the BIOS items, and save or discard your changes to the BIOS items. You can access the EZ Mode from the Exit menu.

### Load Optimized Defaults

This option allows you to load the default values for each of the parameters on the Setup menus. When you select this option or if you press <F5>, a confirmation window appears. Select **OK** to load the default values.

### Save Changes & Reset

Once you are finished making your selections, choose this option from the Exit menu to ensure the values you selected are saved. When you select this option or if you press <F10>, a confirmation window appears. Select **OK** to save changes and exit.

### Discard Changes & Exit

This option allows you to exit the Setup program without saving your changes. When you select this option or if you press <Esc>, a confirmation window appears. Select **Yes** to discard changes and exit.

### Launch EFI Shell from USB drives

This item allows you to attempt to launch the EFI Shell application (shellx64.efi) from one of the available filesystem devices.

## 3.11 Updating BIOS

The ASUS website publishes the latest BIOS versions to provide enhancements on system stability, compatibility, and performance. However, BIOS updating is potentially risky. If there is no problem using the current version of BIOS, DO NOT manually update the BIOS. Inappropriate BIOS updating may result to system's failure to boot. Carefully follow the instructions in this chapter to update your BIOS when necessary.



---

Visit <http://www.asus.com> to download the latest BIOS file for this motherboard.

---

The following utilities allow you to manage and update the motherboard BIOS setup program.

1. **EZ Update:** Updates the BIOS in Windows® environment.
2. **ASUS EZ Flash 3:** Updates the BIOS using a USB flash drive.
3. **ASUS CrashFree BIOS 3:** Restores the BIOS using the motherboard support DVD or a USB flash drive when the BIOS file fails or gets corrupted.

### 3.11.1 EZ Update

The EZ Update is a utility that allows you to update the motherboard BIOS in Windows® environment.



- EZ Update requires an Internet connection either through a network or an ISP (Internet Service Provider).
- This utility is available in the support DVD that comes with the motherboard package.

### 3.11.2 ASUS EZ Flash 3

ASUS EZ Flash 3 allows you to download and update to the latest BIOS through the Internet without having to use a bootable floppy disk or an OS-based utility.



Updating through the Internet varies per region and Internet conditions. Check your local Internet connection before updating through the Internet.

#### To update the BIOS by USB:

1. Enter the Advanced Mode of the BIOS setup program. Go to the Tool menu to select **ASUS EZ Flash Utility** and press <Enter>.
2. Insert the USB flash disk that contains the latest BIOS file to the USB port.
3. Select **via Storage Devices**.

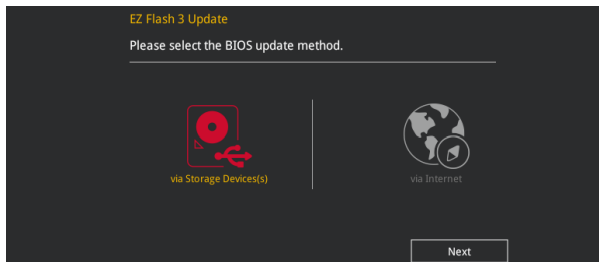

4. Press <Tab> to switch to the Drive field.
5. Press the Up/Down arrow keys to find the USB flash disk that contains the latest BIOS, and then press <Enter>.
6. Press <Tab> to switch to the Folder Info field.
7. Press the Up/Down arrow keys to find the BIOS file, and then press <Enter> to perform the BIOS update process. Reboot the system when the update process is done.

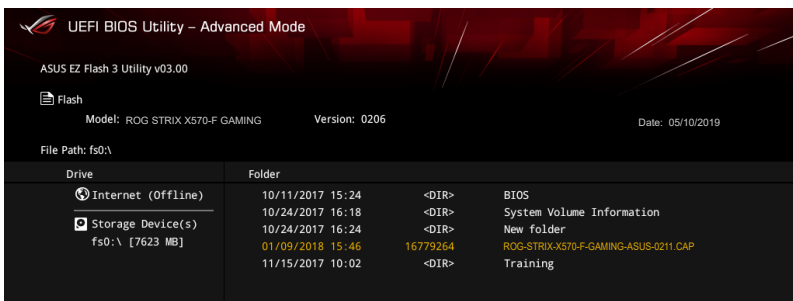

- This function can support devices such as a USB flash disk with FAT 32/16 format and single partition only.
- DO NOT shut down or reset the system while updating the BIOS to prevent system boot failure!



Ensure to load the BIOS default settings to ensure system compatibility and stability. Select the Load Optimized Defaults item under the Exit menu. See section 3.10 **Exit Menu** for details.

### To update the BIOS by Internet:

1. Enter the Advanced Mode of the BIOS setup program. Go to the Tool menu to select **ASUS EZ Flash Utility** and press <Enter>.
2. Select **via Internet**.

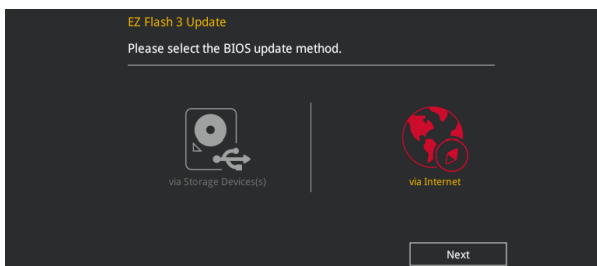

3. Press the Left/Right arrow keys to select an Internet connection method, and then press <Enter>.

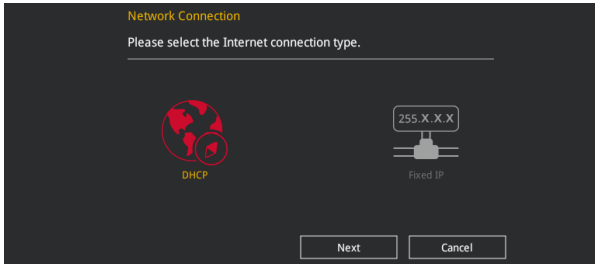

4. Follow the onscreen instructions to complete the update.
5. Reboot the system when the update process is done.



---

Ensure to load the BIOS default settings to ensure system compatibility and stability. Select the Load Optimized Defaults item under the Exit menu. See section 3.10 **Exit Menu** for details.

---

### 3.11.3 ASUS CrashFree BIOS 3

The ASUS CrashFree BIOS 3 utility is an auto recovery tool that allows you to restore the BIOS file when it fails or gets corrupted during the updating process. You can restore a corrupted BIOS file using the motherboard support DVD or a USB flash drive that contains the BIOS file.



---

The BIOS file in the motherboard support DVD may be older than the BIOS file published on the ASUS official website. If you want to use the newer BIOS file, download the file at <https://www.asus.com/support/> and save it to a USB flash drive.

---

## Recovering the BIOS

### To recover the BIOS:

1. Turn on the system.
2. Insert the motherboard support DVD to the optical drive, or the USB flash drive containing the BIOS file to the USB port.
3. The utility automatically checks the devices for the BIOS file. When found, the utility reads the BIOS file and enters ASUS EZ Flash 3 automatically.
4. The system requires you to enter BIOS Setup to recover the BIOS setting. To ensure system compatibility and stability, we recommend that you press <F5> to load default BIOS values.



---

**DO NOT** shut down or reset the system while updating the BIOS! Doing so can cause system boot failure!

---

# RAID Support

# 4

## 4.1 AMD RAID Array configurations

The motherboard comes with the RaidXpert2 Configuration Utility that supports Volume, RAIDABLE, RAID 0, RAID 1, and RAID 10 (depends on system licensing) configurations.



For more information on configuring your RAID sets, please refer to the RAID Configuration Guide which you can find at <https://www.asus.com/support>.

### 4.1.1 RAID definitions

**Volume** provides the ability to link-together storage from one or several disks, regardless of the size of the space on those disks. This configuration is useful in scavenging space on disks unused by other disks in the array. This configuration does not provide performance benefits or data redundancy, disk failure will result in data loss.

**RAIDABLE** arrays (also known as RAID Ready) are a special type of Volume (JBOD) that allows the user to add more storage space or create a redundant array after a system is installed. RAIDABLE arrays are created using Option ROM, UEFI, or roadm.



The ability to create RAIDABLE arrays may vary per system.

**RAID 0 (Data striping)** optimizes two identical hard disk drives to read and write data in parallel, interleaved stacks. Two hard disks perform the same work as a single drive but at a sustained data transfer rate, double that of a single disk alone, thus improving data access and storage. Use of two new identical hard disk drives is required for this setup.

**RAID 1 (Data mirroring)** copies and maintains an identical image of data from one drive to a second drive. If one drive fails, the disk array management software directs all applications to the surviving drive as it contains a complete copy of the data in the other drive. This RAID configuration provides data protection and increases fault tolerance to the entire system. Use two new drives or use an existing drive and a new drive for this setup. The new drive must be of the same size or larger than the existing drive.

**RAID 10** is data striping and data mirroring combined without parity (redundancy data) having to be calculated and written. With the RAID 10 configuration you get all the benefits of both RAID 0 and RAID 1 configurations. Use four new hard disk drives or use an existing drive and three new drives for this setup.





# Appendix

## Notices

### FCC Compliance Information

Responsible Party: Asus Computer International  
Address: 48720 Kato Rd., Fremont, CA 94538, USA  
Phone / Fax No: (510)739-3777 / (510)608-4555

This device complies with part 15 of the FCC Rules. Operation is subject to the following two conditions: (1) This device may not cause harmful interference, and (2) this device must accept any interference received, including interference that may cause undesired operation.

This equipment has been tested and found to comply with the limits for a Class B digital device, pursuant to part 15 of the FCC Rules. These limits are designed to provide reasonable protection against harmful interference in a residential installation. This equipment generates, uses and can radiate radio frequency energy and, if not installed and used in accordance with the instructions, may cause harmful interference to radio communications. However, there is no guarantee that interference will not occur in a particular installation. If this equipment does cause harmful interference to radio or television reception, which can be determined by turning the equipment off and on, the user is encouraged to try to correct the interference by one or more of the following measures:

- Reorient or relocate the receiving antenna.
- Increase the separation between the equipment and receiver.
- Connect the equipment into an outlet on a circuit different from that to which the receiver is connected.
- Consult the dealer or an experienced radio/TV technician for help.

## Compliance Statement of Innovation, Science and Economic Development Canada (ISED)

This device complies with Innovation, Science and Economic Development Canada licence exempt RSS standard(s). Operation is subject to the following two conditions: (1) this device may not cause interference, and (2) this device must accept any interference, including interference that may cause undesired operation of the device.

CAN ICES-3(B)/NMB-3(B)

## Déclaration de conformité de Innovation, Sciences et Développement économique Canada (ISED)

Le présent appareil est conforme aux CNR d'Innovation, Sciences et Développement économique Canada applicables aux appareils radio exempts de licence. L'exploitation est autorisée aux deux conditions suivantes : (1) l'appareil ne doit pas produire de brouillage, et (2) l'utilisateur de l'appareil doit accepter tout brouillage radioélectrique subi, même si le brouillage est susceptible d'en compromettre le fonctionnement.

CAN ICES-3(B)/NMB-3(B)

## VCCI: Japan Compliance Statement

### Class B ITE

この装置は、クラスB情報技術装置です。この装置は、家庭環境で使用することを目的としています。この装置がラジオやテレビジョン受信機に近接して使用されると、受信障害を引き起こすことがあります。

取扱説明書に従って正しい取り扱いをして下さい。

VCCI-B

## KC: Korea Warning Statement

B급 기기 (가정용 방송통신기자재)

이 기기는 가정용(B급) 전자파적합기기로서 주로 가정에서 사용하는 것을 목적으로 하며, 모든 지역에서 사용할 수 있습니다.

## REACH

Complying with the REACH (Registration, Evaluation, Authorisation, and Restriction of Chemicals) regulatory framework, we published the chemical substances in our products at ASUS REACH website at <http://csr.asus.com/english/REACH.htm>.



DO NOT throw the motherboard in municipal waste. This product has been designed to enable proper reuse of parts and recycling. This symbol of the crossed out wheeled bin indicates that the product (electrical and electronic equipment) should not be placed in municipal waste. Check local regulations for disposal of electronic products.



DO NOT throw the mercury-containing button cell battery in municipal waste. This symbol of the crossed out wheeled bin indicates that the battery should not be placed in municipal waste.

## ASUS Recycling/Takeback Services

ASUS recycling and takeback programs come from our commitment to the highest standards for protecting our environment. We believe in providing solutions for you to be able to responsibly recycle our products, batteries, other components as well as the packaging materials. Please go to <http://csr.asus.com/english/Takeback.htm> for detailed recycling information in different regions.

## Regional notice for California



### WARNING

Cancer and Reproductive Harm -  
[www.P65Warnings.ca.gov](http://www.P65Warnings.ca.gov)

## Google™ License Terms

Copyright© 2019 Google Inc. All Rights Reserved.

Licensed under the Apache License, Version 2.0 (the "License"); you may not use this file except in compliance with the License. You may obtain a copy of the License at:

<http://www.apache.org/licenses/LICENSE-2.0>

Unless required by applicable law or agreed to in writing, software distributed under the License is distributed on an "AS IS" BASIS, WITHOUT WARRANTIES OR CONDITIONS OF ANY KIND, either express or implied.

See the License for the specific language governing permissions and limitations under the License.

**English** ASUSTeK Computer Inc. hereby declares that this device is in compliance with the essential requirements and other relevant provisions of related Directives. Full text of EU declaration of conformity is available at: [www.asus.com/support](http://www.asus.com/support)

**Français** AsusTek Computer Inc. déclare par la présente que cet appareil est conforme aux critères essentiels et autres clauses pertinentes des directives concernées. La déclaration de conformité de l'UE peut être téléchargée à partir du site Internet suivant: [www.asus.com/support](http://www.asus.com/support)

**Deutsch** ASUSTeK Computer Inc. erklärt hiermit, dass dieses Gerät mit den wesentlichen Anforderungen und anderen relevanten Bestimmungen der zugehörigen Richtlinien übereinstimmt. Der gesamte Text der EU-Konformitätserklärung ist verfügbar unter: [www.asus.com/support](http://www.asus.com/support)

**Italiano** ASUSTeK Computer Inc. con la presente dichiara che questo dispositivo è conforme ai requisiti essenziali e alle altre disposizioni pertinenti con le direttive correlate. Il testo completo della dichiarazione di conformità UE è disponibile all'indirizzo: [www.asus.com/support](http://www.asus.com/support)

**Русский** Компания ASUS заявляет, что это устройство соответствует основным требованиям и другим соответствующим условиям соответствующих директив. Подробную информацию, пожалуйста, смотрите на [www.asus.com/support](http://www.asus.com/support)

**Български** С настоящото ASUSTeK Computer Inc. декларира, че това устройство е в съответствие със съществените изисквания и другите приложими постановления на свързаните директиви. Пълният текст на декларацията за съответствие на ЕС е достъпен на адрес: [www.asus.com/support](http://www.asus.com/support)

**Hrvatski** ASUSTeK Computer Inc. ovim izjavljuje da je ovaj uređaj sukladan s bitnim zahtjevima i ostalim odgovarajućim odredbama vezanih direktiva. Cijeli tekst EU izjave o sukladnosti dostupan je na: [www.asus.com/support](http://www.asus.com/support)

**Čeština** Společnost ASUSTeK Computer Inc. tímto prohlašuje, že toto zařízení splňuje základní požadavky a další příslušná ustanovení souvisejících směrnic. Plné znění prohlášení o shodě EU je k dispozici na adrese: [www.asus.com/support](http://www.asus.com/support)

**Dansk** ASUSTeK Computer Inc. erklærer hermed, at denne enhed er i overensstemmelse med hovedkravene og andre relevante bestemmelser i de relaterede direktiver. Hele EU-overensstemmelseserklæringen kan findes på: [www.asus.com/support](http://www.asus.com/support)

**Nederlands** ASUSTeK Computer Inc. verklaart hierbij dat dit apparaat voldoet aan de essentiële vereisten en andere relevante bepalingen van de verwante richtlijnen. De volledige tekst van de EU-verklaring van conformiteit is beschikbaar op: [www.asus.com/support](http://www.asus.com/support)

**Eesti** Käesolevaga kinnitab ASUSTeK Computer Inc, et see seade vastab asjakohaste direktiivide olulistele nõuetele ja teisteles asjassepuutuvatele sätetele. El vastavusdeklaratsiooni täielik tekst on saadaval järgmisel aadressil: [www.asus.com/support](http://www.asus.com/support)

**Suomi** ASUSTeK Computer Inc. ilmoittaa täten, että tämä laite on asiaankuuluvien direktiivien olennaisten vaatimusten ja muiden tätä koskevien säädösten mukainen. EU-yhdenmukaisuusilmoituksen koko teksti on luettavissa osoitteessa: [www.asus.com/support](http://www.asus.com/support)

**Ελληνικά** Με το παρόν, η ASUSTeK Computer Inc. δηλώνει ότι αυτή η συσκευή συμμορφώνεται με τις θεμελιώδεις απαιτήσεις και άλλες σχετικές διατάξεις των Οδηγιών της ΕΕ. Το πλήρες κείμενο της δήλωσης συμμόρφωσης είναι διαθέσιμο στη διεύθυνση: [www.asus.com/support](http://www.asus.com/support)

**Magyar** Az ASUSTeK Computer Inc. ezennel kijelenti, hogy ez az eszköz megfelel a kapcsolódó irányelvek lényeges követelményeinek és egyéb vonatkozó rendelkezéseinek. Az EU megfélelősegi nyilatkozat teljes szövege innen letölthető: [www.asus.com/support](http://www.asus.com/support)

**Latviski** ASUSTeK Computer Inc. ar šo paziņo, ka šī ierīce atbilst saistošo Direktīvu būtiskajām prasībām un citiem citiem saistošajiem nosacījumiem. Pilns ES atbilstības paziņojuma teksts pieejams šeit: [www.asus.com/support](http://www.asus.com/support)

**Lietuvių** „ASUSTeK Computer Inc.“ šiuo tvirtina, kad šis įrenginys atitinka pagrindinius reikalavimus ir kitas svarbias susijusių direktyvų nuostatas. Visą ES atitikties deklaracijos tekstą galima rasti: [www.asus.com/support](http://www.asus.com/support)

**Norsk** ASUSTeK Computer Inc. erklærer herved at denne enheten er i samsvar med hovedsaklige krav og andre relevante forskrifter i relaterede direktiver. Fullstendig tekst for EU-samsvarserklæringen finnes på: [www.asus.com/support](http://www.asus.com/support)

**Polski** Firma ASUSTeK Computer Inc. niniejszym oświadcza, że urządzenie to jest zgodne z zasadniczymi wymogami i innymi właściwymi postanowieniami powiązanych dyrektyw. Pełny tekst deklaracji zgodności UE jest dostępny pod adresem: [www.asus.com/support](http://www.asus.com/support)

**Português** A ASUSTeK Computer Inc. declara que este dispositivo está em conformidade com os requisitos essenciais e outras disposições relevantes das Diretivas relacionadas. Texto integral da declaração da UE disponível em: [www.asus.com/support](http://www.asus.com/support)

**Română** ASUSTeK Computer Inc. declară că acest dispozitiv se conformează cerințelor esențiale și altor prevederi relevante ale directivelor conexe. Textul complet al declarației de conformitate a Uniunii Europene se găsește la: [www.asus.com/support](http://www.asus.com/support)

**Srpski** ASUSTeK Computer Inc. ovim izjavljuje da je ovaj uređaj u saglasnosti sa osnovnim zahtevima i drugim relevantnijim odredbama povezanih Direktiva. Pun tekst EU deklaracije o usaglasjenosti je dostupan da adres: [www.asus.com/support](http://www.asus.com/support)

**Slovensky** Spoločnosť ASUSTeK Computer Inc. týmto vyhlasuje, že toto zariadenie vyhovuje základným požiadavkám a ostatým príslušným ustanoveniam príslušných smerníc. Celý text vyhlásenia o zhode pre štáty EÚ je dostupný na adrese: [www.asus.com/support](http://www.asus.com/support)

**Slovenščina** ASUSTeK Computer Inc. izjavlja, da je ta naprava skladna z bistvenimi zahtevami in drugimi ustreznimi določbami povezanih direktiv. Celotno besedilo EU-izjave o skladnosti je na voljo na spletnem mestu: [www.asus.com/support](http://www.asus.com/support)

**Español** Por la presente, ASUSTeK Computer Inc. declara que este dispositivo cumple los requisitos básicos y otras disposiciones pertinentes de las directivas relacionadas. El texto completo de la declaración de la UE de conformidad está disponible en: [www.asus.com/support](http://www.asus.com/support)

**Svenska** ASUSTeK Computer Inc. förklarar härmed att denna enhet överensstämmer med de grundläggande kraven och andra relevanta föreskrifter i relaterade direktiv. Fulltext av EU-försäkran om överensstämmelse finns på: [www.asus.com/support](http://www.asus.com/support)

**Українська** ASUSTeK Computer Inc. заявляє, що цей пристрій відповідає основним вимогам та іншим відповідним положенням відповідних Директив. Повний текст декларації відповідності стандартам ЄС доступний на: [www.asus.com/support](http://www.asus.com/support)

**Türkçe** ASUSTeK Computer Inc., bu aygıtın temel gereksinimlerle ve ilişkili Yönergelerin diğer ilgili kullarıyla uyumlu olduğunu beyan eder. AB uygunluk bildirimini tam metni şu adreste bulunabilir: [www.asus.com/support](http://www.asus.com/support)

**Bosanski** ASUSTeK Computer Inc. ovim izjavljuje da je ovaj uređaj uskladen sa bitnim zahtjevima i ostalim odgovarajućim odredbama vezanih direktiva. Cijeli tekst EU izjave o uskladenosti dostupan je na: [www.asus.com/support](http://www.asus.com/support)

## ASUS contact information

### ASUSTeK COMPUTER INC.

Address 4F, No. 150, Li-Te Road, Peitou, Taipei 112, Taiwan  
Telephone +886-2-2894-3447  
Fax +886-2-2890-7798  
Web site [www.asus.com](http://www.asus.com)

#### **Technical Support**

Telephone +86-21-38429911  
Fax +86-21-5866-8722, ext. 9101#  
Online support <http://qr.asus.com/techserv>

### ASUS COMPUTER INTERNATIONAL (America)

Address 48720 Kato Rd., Fremont, CA 94538, USA  
Telephone +1-510-739-3777  
Fax +1-510-608-4555  
Web site <http://www.asus.com/us/>

#### **Technical Support**

Support fax +1-812-284-0883  
Telephone +1-812-282-2787  
Online support <http://qr.asus.com/techserv>

### ASUS COMPUTER GmbH (Germany and Austria)

Address Harkort Str. 21-23, 40880 Ratingen, Germany  
Fax +49-2102-959931  
Web site <http://www.asus.com/de>  
Online contact <http://eu-rma.asus.com/sales>

#### **Technical Support**

Telephone +49-2102-5789555  
Support Fax +49-2102-959911  
Online support <http://qr.asus.com/techserv>

