

# E79

## 5MP Outdoor Dome with D/N, Adaptive IR, Extreme WDR, SLLS, Fixed Lens



- 5 Megapixel
- Day & Night with Superior Low Light Sensitivity and Adaptive IR LED
- Fixed Lens with f2.1mm / F1.8
- Extreme WDR (116 dB)
- 30 fps at 2592 x 1944
- Wide Angle
- Weatherproof (IP68) and Vandal Proof (IK10)
- Built-in Analytics



### PHOTO INDICATION

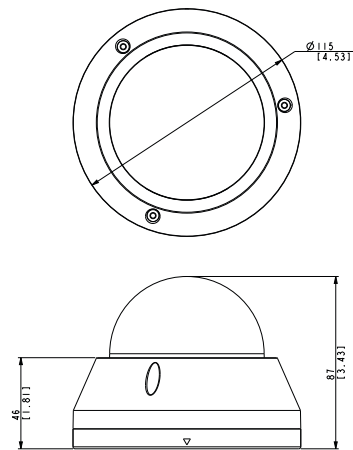
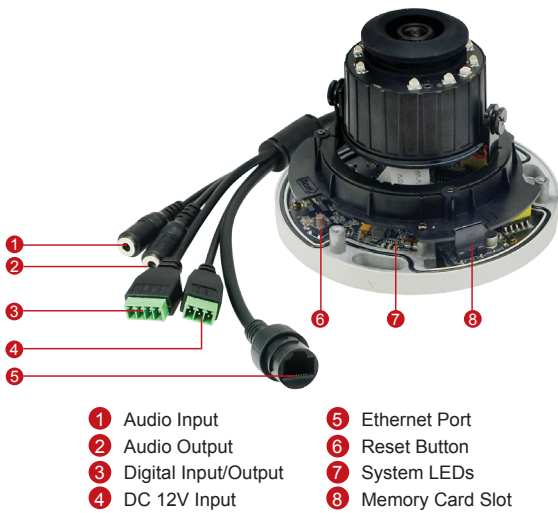







### DIMENSION DIAGRAM



Unit: mm [inch]

### ACCESSORY OPTIONS

Dome Cover		
PDCX-1113		Vandal Proof Smoked Dome Cover
Power Supply		
PPOE-0001		IEEE 802.3af PoE Injector for Class 1, 2 or 3 devices, with universal adapter
PPBX-0011		AC 100-240V to DC 12V power adapter with universal connector

Popular Mounting Solutions	
Surface	Accessories not required
Wall	PMAX-0316 
Pendant	PMAX-0111  + PMAX-1400 
Pole	PMAX-0316  + PMAX-0506 
Flush	PMAX-1021 
Gang Box	PMAX-0805 
NPT Standard Mounts	PMAX-0809  + PMAX-1400 

\* For more mounting solutions, please refer to the Mounting Accessory Selector on [www.acti.com/mountingselector/](http://www.acti.com/mountingselector/)

## PRODUCT SPECIFICATION

### • Device

Device Type	Outdoor Dome Camera
Image Sensor	Progressive Scan CMOS
Sensor Size	1/2.9"
Effective Pixels	3096 (H) x 2209 (V) (6.82 MP)
Horizontal Resolution	1650 TVL
Day / Night	Yes
Low Light Sensitivity	Superior
Minimum Illumination	Color: 0.1 lux at F1.8 (30 IRE, 2400°K) B/W: 0 lux at F1.8 (IR LED on)
Color to B/W Switch	ISP based switch, configurable
Mechanical IR Cut Filter	Yes
IR Sensitivity Range	700~1100nm
IR LED	Adaptive IR LED x 10 (850nm)
IR Working Distance	30 m
Electronic Shutter	1/5" ~ 1/64000" (manual mode, 60 Hz) 1/5" ~ 1/64000" (auto mode, 60 Hz)
S/N Ratio	56 dB

### • Lens

Focal Length / Aperture	Fixed focal, f2.1mm / F1.8
Iris	Fixed iris
Focus	Fixed focus
Mount Type	Board mount
Horizontal Viewing Angle	120°
Viewing Angle Adjustment	Pan: -175 ~ 175° Tilt: 5° ~ 175° Rotation: -175 ~ 175°

### • Video

Compression	H.265, H.264 (Baseline / Main / High profile), MJPEG
Max. Frame Rate vs. Resolution	30 fps at 2592 x 1944 30 fps at 2048 x 1536 30 fps at 1920 x 1080 30 fps at 1280 x 960 30 fps at 1280 x 720 30 fps at 800 x 600 30 fps at 640 x 480 30 fps at 320 x 240
Multi-Streaming	Simultaneous triple streams based on three configurations
Bit Rate	128 Kbps ~ 12 Mbps (per stream)
Bit Rate Mode	Constant, Variable
Image Enhancement	Extreme WDR (116 dB), Digital Image Stabilizer, Defogging, White Balance, Brightness, Contrast, Saturation, Sharpness, Automatic gain control, Flickerless
Privacy Mask	4 configurable regions
Text Overlay	User defined text on video
Built-in Analytics	Object Based Motion Detection, Tampering Detection, Shock Detection
Image Orientation	Flip, Mirror, Rotation

### • Audio

Compression	8kHz, Mono, PCM, 16 bit encoding, G.711
Audio Type	2-way, Built-in Microphone, Mic-in, Line-in, Line-out
Audio-In	Cable with 3.5mm phone jack
Audio-Out	Cable with 3.5mm phone jack

### • Network

Protocol & Service	IPv4/v6, TCP, UDP, DHCP, PPPoE, HTTP, HTTPS, DNS, DDNS, NTP, RTP, RTSP, RTCP, SMTP, FTP, IGMP, ICMP, ARP, Bonjour, UPnP, QoS, SNMP, IEEE 802.1xx
Ethernet Port	1 x RJ-45 connector
Security	IP Address Filtering, HTTPS Encryption, Password Protected User Level, Anonymous Login, IEEE 802.1x Network Access Control

### • Alarm

Alarm Trigger	Video Motion Detection (10 Regions), External Device through Digital Input, Sound Detection
Alarm Response	Notify Control Center, Change Camera Settings, Command other Devices, E-mail Notification with Snapshots, Push Notification to Mobile Device, Save Video to Local Storage, Upload Video to NVR Server, Upload Video or Snapshot to FTP Server

### • Interface

Digital Input	1, Cable with Terminal Block
Digital Output	1, Cable with Terminal Block
Local Storage	MicroSDHC memory card slot (card not included)

### • General

Power Source / Consumption	PoE Class 2 (IEEE802.3af) / 5.04W DC 12V (adapter not included) / 3.96W
Weight	551g (1.21lb)
Dimensions (Ø x H)	115 x 87 mm (5.53" x 3.43")
Environmental Casing	Weatherproof (IP68 rated) Vandal proof (IK10 rated) Transparent dome cover
Mount Type	Surface, Gang Box, Flush, Pendant, Converter for NPT Standard Mounts, Wall Mount, Pole Mount, Corner Mount
Starting Temperature	-40°C ~ 50°C (-40°F ~ 122°F)
Operating Temperature	-40°C ~ 50°C (-40°F ~ 122°F)
Operating Humidity	10% ~ 85% RH
Approvals	CE (EN 55022 Class B, EN 55024), FCC (Part15 Subpart B Class B); IP68, IK10, NEMA 4X, UL (for optional power adapter and PoE injector)

### • Integration

Unified Solution	Fully compatible with ACTi software
ISV Integration	Software Development Kit (SDK) available; ONVIF compliant; GB28181 compliant
Firmware Access Browser	IE 11
Auto Firmware Upgrade	Yes
GPS Position	Manual Setting