

NEC

Desktop Monitor

MultiSync EA271Q

User's Manual

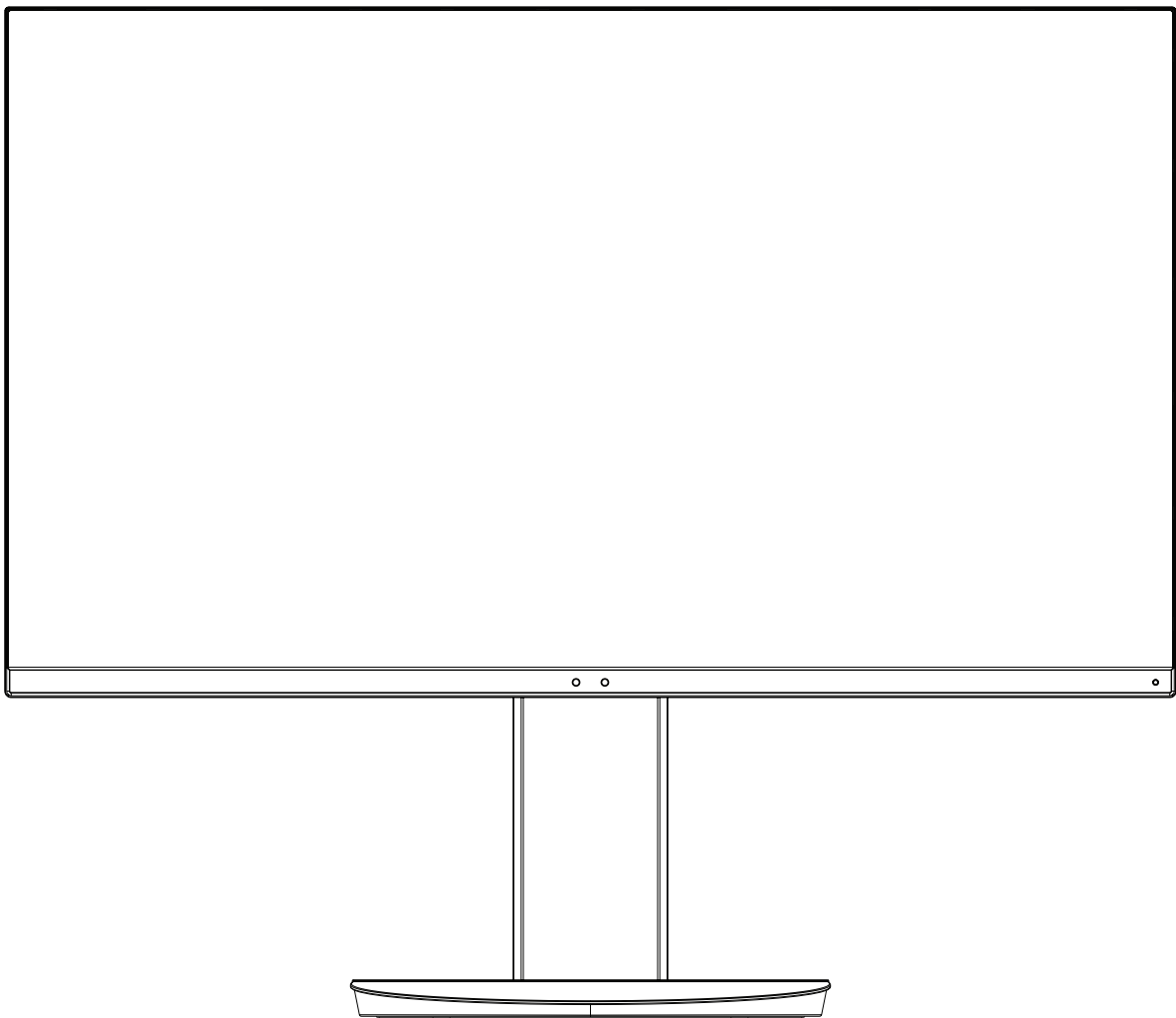

MODEL: EA271Q, EA271Q-BK

The regulations for this monitor applied to one of model names listed above.

Please find your model name in the label on the rear side of the monitor.

Index

WARNING	English-1
CAUTION	English-1
Registration Information	English-2
Recommended use	English-3
Safety Precautions and Maintenance	English-3
Ergonomics	English-4
Cleaning the LCD Panel.....	English-4
Cleaning the Cabinet.....	English-4
Parts Name and Functions	English-5
Quick Start.....	English-6
ControlSync.....	English-11
Multiple monitors connection using DisplayPort.....	English-13
Controls	English-14
Using the PICTURE MODE function	English-24
Specifications	English-25
Features	English-27
Troubleshooting.....	English-28
Human sensing function.....	English-30
Multi Display setting	English-31
Using the Auto Brightness function	English-33
Using the MULTI PICTURE function	English-34
Using the Zoom function	English-35
Manufacturer's Recycling and Energy Information.....	English-37

WARNING





TO PREVENT FIRE OR SHOCK HAZARDS, DO NOT EXPOSE THIS UNIT TO RAIN OR MOISTURE. ALSO, DO NOT USE THIS UNIT'S POLARIZED PLUG WITH AN EXTENSION CORD RECEPTACLE OR OTHER OUTLETS UNLESS THE PRONGS CAN BE FULLY INSERTED.

REFRAIN FROM OPENING THE CABINET AS THERE ARE HIGH VOLTAGE COMPONENTS INSIDE. REFER SERVICING TO QUALIFIED SERVICE PERSONNEL.

CAUTION





TO REDUCE THE RISK OF ELECTRIC SHOCK, MAKE SURE POWER CORD IS UNPLUGGED FROM WALL SOCKET. TO FULLY DISENGAGE THE POWER TO THE UNIT, PLEASE DISCONNECT THE POWER CORD FROM THE AC OUTLET. DO NOT REMOVE COVER (OR BACK). NO USER SERVICEABLE PARTS INSIDE. REFER SERVICING TO QUALIFIED SERVICE PERSONNEL.

-  This symbol warns user that uninsulated voltage within the unit may have sufficient magnitude to cause electric shock. Therefore, it is dangerous to make any kind of contact with any part inside this unit.
-  This symbol alerts the user that important literature concerning the operation and maintenance of this unit has been included. Therefore, it should be read carefully in order to avoid any problems.

CAUTION: Please use the power cord provided with this display in accordance with the table below. If a power cord is not supplied with this equipment, please contact NEC. For all other cases, please use the power cord with the plug style that matches the power socket where the monitor is located. The compatible power cord corresponds to the AC voltage of the power outlet and has been approved by, and complies with, the safety standards in the country of purchase.

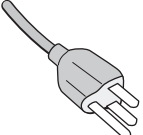
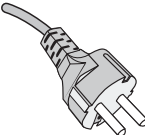
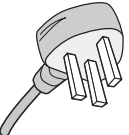
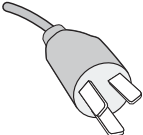
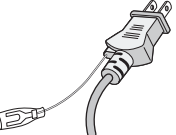
This equipment is designed to be used in the condition of the power cord connected to earth. If the power cord is not connected to the earth, it may cause electric shock. Please make sure the power cord is earthed properly.

Plug Type	North America	European Continental	U.K.	Chinese	Japanese
Plug Shape					
Region	U.S.A./Canada	EU	U.K.	China	Japan
Voltage	120*	230	230	220	100

*When operating the monitor with its AC 125-240V power supply, use a power supply cord that matches the power supply voltage of the AC power outlet being used.

NOTE: This product can only be serviced in the country where it was purchased.

Windows is a registered trademark of Microsoft Corporation. NEC is a registered trademark of NEC Corporation. ErgoDesign is a registered trademark of NEC Display Solutions, Ltd. in Austria, Benelux, Denmark, France, Germany, Italy, Norway, Spain, Sweden, U.K.

ENERGY STAR is a U.S. registered trademark. All other brands and product names are trademarks or registered trademarks of their respective owners. As an ENERGY STAR® Partner, NEC Display Solutions of America, Inc. has determined that this product meets the ENERGY STAR guidelines for energy efficiency. The ENERGY STAR emblem does not represent EPA endorsement of any product or service.

DisplayPort and DisplayPort Compliance Logo are trademarks owned by Video Electronics Standards Association in the United States and other countries.



HDCP (High-bandwidth Digital Content Protection): HDCP is a system for preventing illegal copying of video data sent over a digital signal. If you are unable to view material via the digital signal input, this does not necessarily mean the display is not functioning properly. With the implementation of HDCP, there may be cases in which certain content is protected with HDCP and might not be displayed due to the decision/intention of the HDCP community (Digital Content Protection, LLC).

The terms HDMI and HDMI High-Definition Multimedia Interface, and the HDMI Logo are trademarks or registered trademarks of HDMI Licensing Administrator, Inc. in the United States and other countries.



- The intended primary use of this product is as an Information Technical Equipment in an office or domestic environment.
- The product is intended to be connected to a computer and is not intended for the display of television broadcast signals.



Registration Information

Cable information

- ⚠ CAUTION:** Use the attached specified cables with this monitor so as not to interfere with radio and television reception. For DVI, please use a shielded signal cable with ferrite core. For HDMI, DisplayPort, USB and USB-C, please use a shielded signal cable. Use of other cables and adapters may cause interference with radio and television reception.

FCC Information

- ⚠ WARNING:** The Federal Communications Commission does not allow any modifications or changes to the unit EXCEPT those specified by NEC Display Solutions of America, Inc. in this manual. Failure to comply with this government regulation could void your right to operate this equipment.

1. The power supply cord you use must have been approved by and comply with the safety standards of U.S.A., and meet the following condition.

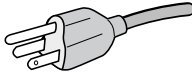
Power supply cord Plug shape	Non shield type, 3-conductor  U.S.A
---------------------------------	--

2. This equipment has been tested and found to comply with the limits for a Class B digital device, pursuant to part 15 of the FCC Rules. These limits are designed to provide reasonable protection against harmful interference in a residential installation. This equipment generates, uses and can radiate radio frequency energy, and, if not installed and used in accordance with the instructions, may cause harmful interference to radio communications. However, there is no guarantee that interference will not occur in a particular installation. If this equipment does cause harmful interference to radio or television reception, which can be determined by turning the equipment off and on, the user is encouraged to try to correct the interference by one or more of the following measures:
 - Reorient or relocate the receiving antenna.
 - Increase the separation between the equipment and receiver.
 - Connect the equipment into an outlet on a circuit different from that to which the receiver is connected.
 - Consult the dealer or an experienced radio/TV technician for help.

If necessary, the user should contact the dealer or an experienced radio/television technician for additional suggestions. The user may find the following booklet, prepared by the Federal Communications Commission, helpful: "How to Identify and Resolve Radio-TV Interference Problems." This booklet is available from the U.S. Government Printing Office, Washington, D.C., 20402, Stock No. 004-000-00345-4.

Declaration of Conformity

This device complies with Part 15 of FCC Rules. Operation is subject to the following two conditions. (1) This device may not cause harmful interference, and (2) this device must accept any interference received, including interference that may cause undesired operation.

U.S. Responsible Party:	NEC Display Solutions of America, Inc.
Address:	3250 Lacey Road Downers Grove, Illinois 60515
Tel. No.:	(630) 467-3000

Type of Product: Display Monitor
Equipment Classification: Class B Peripheral
Model: MultiSync EA271Q (EA271Q, EA271Q-BK)



We hereby declare that the equipment specified above conforms to the technical standards as specified in the FCC Rules.

To see a list of our TCO certified monitors and their TCO Certification (in English only), visit our website at

https://www.nec-display.com/global/about/legal_regulation/TCO_mn/index.html

- ⚠ CAUTION:** Please confirm the distribution system in building installation shall provide the circuit breaker rated 120/240V, 20A (maximum).

Recommended use

Safety Precautions and Maintenance



WARNING

FOR OPTIMUM PERFORMANCE, PLEASE NOTE
THE FOLLOWING WHEN SETTING UP AND
USING THE LCD COLOR MONITOR:

- **DO NOT OPEN THE MONITOR.** There are no user serviceable parts inside and opening or removing covers may expose you to dangerous shock hazards or other risks. Refer all servicing to qualified service personnel.
- Do not spill any liquids into the cabinet or use your monitor near water.
- Do not insert objects of any kind into the cabinet slots as they may touch dangerous voltage points, which can be harmful or fatal, or may cause electric shock, fire or equipment failure.
- Do not place any heavy objects on the power cord. Damage to the cord may cause shock or fire.
- Do not place this product on a sloping or unstable cart, stand or table, as the monitor may fall, causing serious damage to the monitor.
- The power supply cord you use must have been approved by and comply with the safety standards of your country. (e.g. Type H05VV-F 3G 0.75 mm² should be used in Europe).
- In the UK use a BS-approved power cord with a molded plug having a black (5A) fuse installed for use with this monitor.
- Do not use the monitor outdoors.
- Do not bend, crimp or otherwise damage the power cord.
- Do not use the monitor in high temperature, humid, dusty, or oily areas.
- Do not cover the vent on the monitor.
- Vibration can damage the backlight. Do not install in areas where the monitor will be exposed to continual vibration.
- If monitor or glass is broken, do not come in contact with the liquid crystal and handle with care.
- To prevent damage to the LCD monitor caused by tipping over due to earthquakes or other shocks, make sure to install the monitor in a stable location and take measures to prevent falling.
- Immediately turn off the power, unplug your monitor from the wall outlet and move to a safe location, then refer servicing to qualified service personnel under the following conditions. If the monitor is used in this condition, the monitor may cause fall, fire and electric shock:
 - If the monitor stand has been cracked or peeled.
 - If you notice any structural damage such as cracks or unnatural wobbling.
 - If the monitor has an unusual odor.
 - If the power supply cord or plug is damaged.
 - If liquid has spilled or objects have fallen into the monitor.
 - If the monitor has been exposed to rain or water.
 - If the monitor has been dropped or the cabinet has been damaged.
 - If the monitor does not operate normally by following operating instructions.



CAUTION

- Allow adequate ventilation around the monitor so that heat can properly dissipate. Do not block ventilated openings or place the monitor near a radiator or other heat sources.
- Do not put anything on top of the monitor.
- The power cable connector is the primary means of detaching the system from the power supply. The monitor should be installed close to a power outlet which is easily accessible.
- Handle with care when transporting. Save packaging for transporting.
- Handle with care during installation and adjustment to prevent personal injury and damage to the monitor.
- Do not connect headphones to the monitor while you are wearing them. Depending on the volume level, it may damage your ears and cause loss of hearing.
- Please tighten all screws. A loose screw may cause the monitor to fall off the arm or stand.
- Do not touch the LCD panel surface while transporting, mounting and setting. Applying pressure on the LCD panel can cause serious damage.

Image Persistence: Image persistence occurs when a residual or “ghost” image of a previous image remains visible on the screen. Unlike CRT monitors, LCD monitors’ image persistence is not permanent, but a still image being displayed for a long period of time should be avoided.

To alleviate image persistence, turn off the monitor for as long as the previous image was displayed. For example, if an image was on the monitor for one hour and a residual image remains, the monitor should be turned off for one hour to erase the image.

NOTE: As with all personal display devices, NEC DISPLAY SOLUTIONS recommends using a moving screen saver at regular intervals whenever the screen is idle, or turn off the monitor when not in use.

**CORRECT PLACEMENT AND ADJUSTMENT OF THE MONITOR CAN
REDUCE EYE, SHOULDER, AND NECK FATIGUE. CHECK THE
FOLLOWING WHEN YOU POSITION THE MONITOR:**

Ergonomics

To realize the maximum ergonomics benefits, we recommend the following:

- For optimum performance of the monitor, allow 20 minutes for warming up. Avoid reproduction of still patterns on the monitor for long periods of time to avoid image persistence (after image effects).
- Adjust the monitor height so that the top of the screen is at or slightly below eye level. Your eyes should look slightly downward when viewing the middle of the screen.
- Position your monitor no closer than 40 cm (15.75 inches) and no further away than 70 cm (27.56 inches) from your eyes. The optimal distance is 50 cm (19.69 inches).
- Rest your eyes periodically for 5 to 10 minutes for every 1 hour by focusing on an object at least 20 feet away.
- Position the monitor at a 90° angle to windows and other light sources to minimize glare and reflections. Adjust the monitor tilt so that ceiling lights do not reflect on your screen.
- If reflected light makes it hard for you to see your screen, use an anti-glare filter.
- Adjust the monitor's brightness and contrast controls to enhance readability.
- Use a document holder placed close to the screen.
- Position whatever you are looking at most of the time (the screen or reference material) directly in front of you to minimize turning your head while you are typing.
- Blink often. Eye exercise helps to reduce eye strain. Please contact your ophthalmologist. Get regular eye checkups.
- To avoid eye fatigue, adjust the brightness to a moderate setting. Place a sheet of white paper next to the LCD screen for luminance reference.
- Do not position the Contrast control to its maximum setting.
- Use the preset Size and Position controls with standard signals.
- Use the preset Color Setting.
- Use non-interlaced signals.
- Do not use primary color blue on a dark background, as it is difficult to see and may produce eye fatigue due to insufficient contrast.
- Suitable for entertainment purposes at controlled luminous environments, to avoid disturbing reflections from the screen.

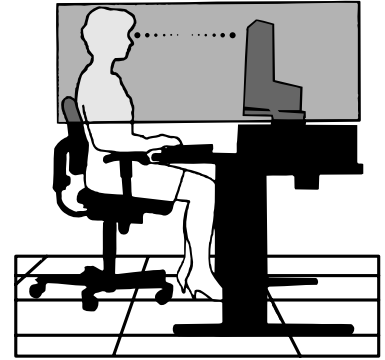

Cleaning the LCD Panel

- When the LCD is dusty, please gently wipe with a soft cloth.
- Clean the LCD monitor surface with a lint-free, non-abrasive cloth. Avoid using any cleaning solution or glass cleaner!
- Please do not rub the LCD panel with hard or coarse material.
- Please do not apply pressure to the LCD surface.
- Please do not use OA cleaner as it will cause deterioration or discoloration on the LCD panel surface.

Cleaning the Cabinet

- Unplug the power supply
- Gently wipe the cabinet with a soft cloth
- To clean the cabinet, dampen the cloth with a neutral detergent and water, wipe the cabinet and follow with a dry cloth.

NOTE: DO NOT clean with benzene thinner, alkaline detergent, alcoholic system detergent, glass cleaner, wax, polish cleaner, soap powder, or insecticide. Rubber or vinyl should not be in contact with the cabinet for an extended period of time. These types of fluids and materials can cause the paint to deteriorate, crack or peel.

For more detailed information on setting up a healthy work environment, write to the American National Standard for Human Factors Engineering of Computer Workstations - ANSI/HFES 100-2007 - The Human Factors Society, Inc. P.O. Box 1369, Santa Monica, California 90406.

Parts Name and Functions

Control Panel

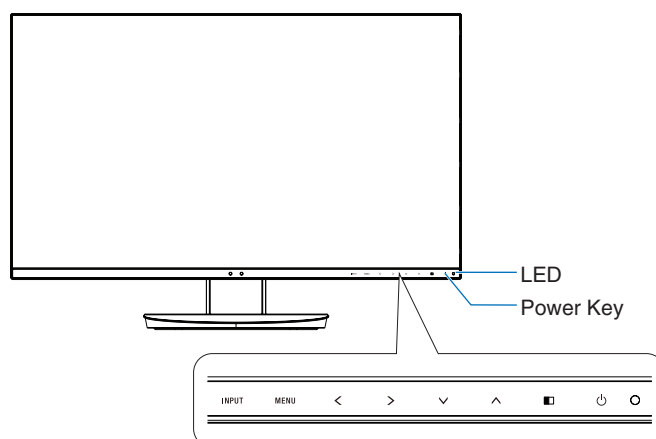

Control buttons

Refer to the **Controls** section. See [page 14](#).

Terminal Panel

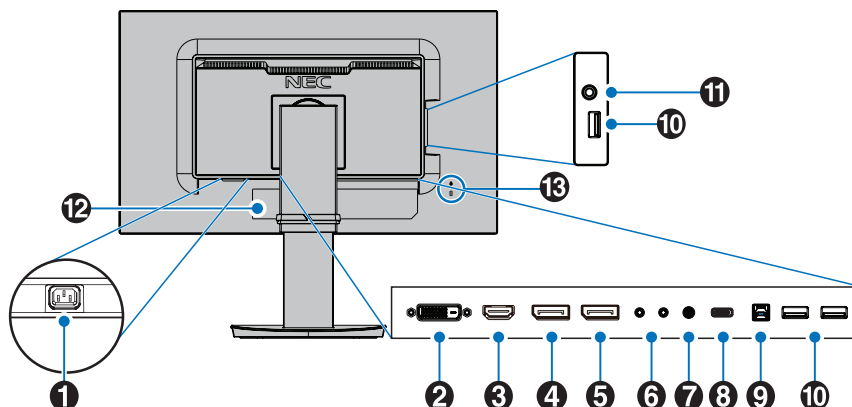

1 AC IN Connector

Connects with the supplied power cord.

2 DVI IN

DVI signals input.

3 HDMI IN

HDMI signals input.

4 DisplayPort IN

DisplayPort signals input.

5 DisplayPort OUT

DisplayPort signals outputs.

Connects with DisplayPort input of another monitor.

6 ControlSync IN/OUT

Connects with the supplied ControlSync cable. See [page 11](#).

7 Audio IN

Audio signal input from external equipment such as a computer or player.

8 USB-C Port

Connects with USB Type-C compliant external equipment such as a computer.

9 USB Upstream Port (Type-B)

Connects with external equipment such as a computer. Please use this port to control the monitor from connected external equipment.

10 USB Downstream Port (Type-A)

Connects with USB devices.

Connects with external equipment such as a computer compliant with USB.

11 Headphone Jack

Connects with headphones.

⚠ CAUTION: Do not connect headphones to the monitor while you are wearing them. Depending on the volume level, it may damage your ears and cause loss of hearing.

12 Rating Label

13 Security Slot

Security and theft protection lock slot compatible with Kensington security cables/equipment. For products visit Kensington's website.

Quick Start

For box contents, please refer to the printed contents sheet provided in the box.

To attach the base to the LCD monitor stand:

1. Place the monitor face down on a non-abrasive surface (**Figure 1**)
2. Please rotate the stand 90 degrees as shown in **Figure 1**.

CAUTION: Handle with care when pulling the stand. It may pinch your fingers.

3. Attach the base to the stand, then tighten the screw at the base's bottom (**Figure 2**).

NOTE: Reverse this procedure if you need to re-pack the monitor.

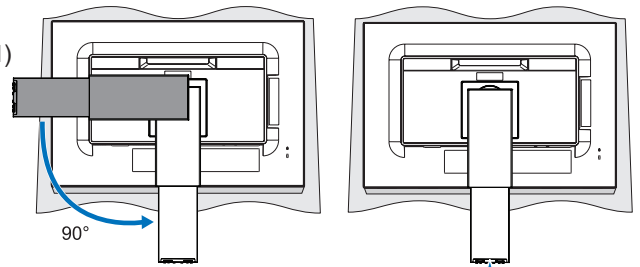

Figure 1

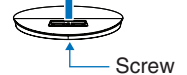

Figure 2

To connect the LCD monitor to your system, follow these instructions:

NOTE: Make sure to read "Recommended Use" ([page 3](#)) before installation.

CAUTION: Please tighten all screws.

NOTE: The accessories included will depend on the location where the LCD monitor was shipped.

1. Turn off the power for your computer.
2. **For a PC with DisplayPort output:** Connect the DisplayPort cable to the connector of the display card in your system (**Figure A.1**).

For a PC with HDMI output: Connect the HDMI cable to the connector of the display card in your system (**Figure A.2**).

For a Mac or PC with Thunderbolt or Mini DisplayPort output: Connect a Mini DisplayPort to DisplayPort cable to the video output connector on your system (**Figure A.3**).

For a PC or MAC with DVI digital output: Connect the DVI signal cable to the connector of the display card in your system (**Figure A.4**). Tighten all screws.

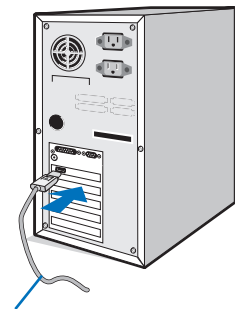

DisplayPort cable

Figure A.1

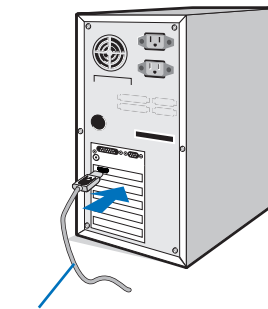

HDMI cable

Figure A.2

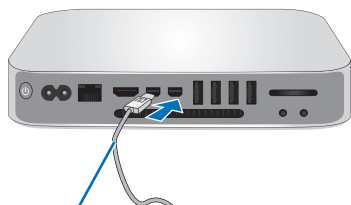

Mini DisplayPort to DisplayPort cable

Figure A.3

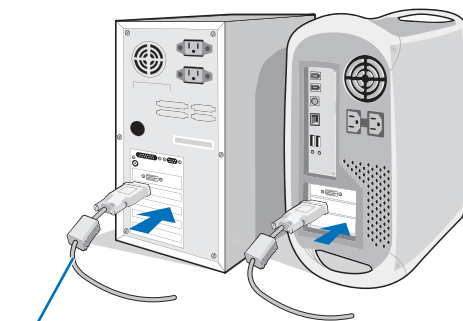

DVI cable

Figure A.4

- NOTE:**
- When removing the DisplayPort cable, hold down the top button to release the lock.
 - Please use a High Speed HDMI cable with the HDMI logo.
 - Please use a certified DisplayPort cable.

- Place your hands on each side of the monitor to tilt the LCD panel to the maximum tilt angle and lift up to the highest position.
- Connect all cables to the appropriate connectors (**Figure C.1**). When using the USB cable, connect the B type connector to the USB upstream port on the rear side of the monitor and the A type connector to the downstream port on the computer (**Figure C.1a**). If using the cord from a USB device, plug into the downstream port of the monitor.

NOTE: Incorrect cable connections may cause abnormal operation, damage display quality/components of the LCD module and/or shorten the module's life.

CAUTION: Do not bind the USB cable. It may trap heat and start a fire.

NOTE: Do not use an attenuating (built-in resistor) audio cable. Using an audio cable with a built-in resistor will lower the sound level.

NOTE: Adjustment of the volume control as well as the equalizer to settings other than the center position may increase the ear-/headphones output voltage and therefore the sound pressure level.

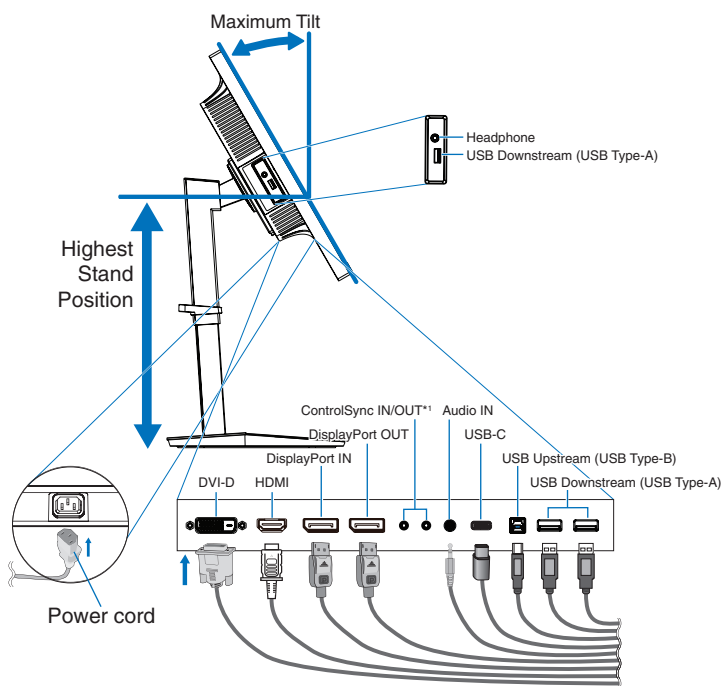

Figure C.1

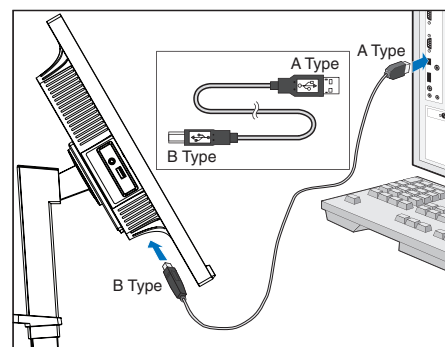

Figure C.1a

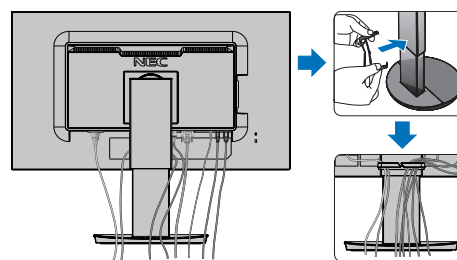

Figure C.2

*1: See [page 11](#).

CAUTION: Do not connect headphones to the monitor while you are wearing them. Depending on the volume level, it may damage your ears and cause loss of hearing.

- Place the cable holder onto the stand (**Figure C.2**). Place the cables in the cable holder firmly and evenly (**Figure C.3** and **Figure C.4**).
- Please check that you can still, raise and lower the monitor screen after you have installed the cables.

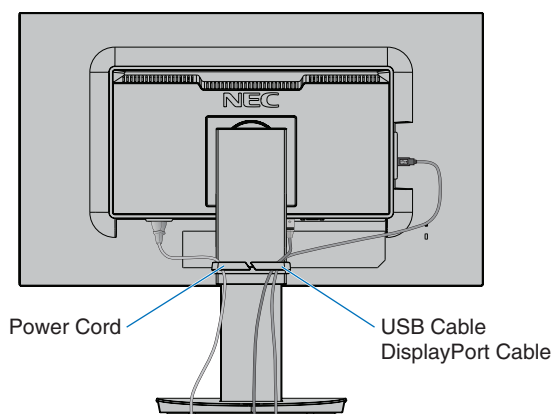

Figure C.3

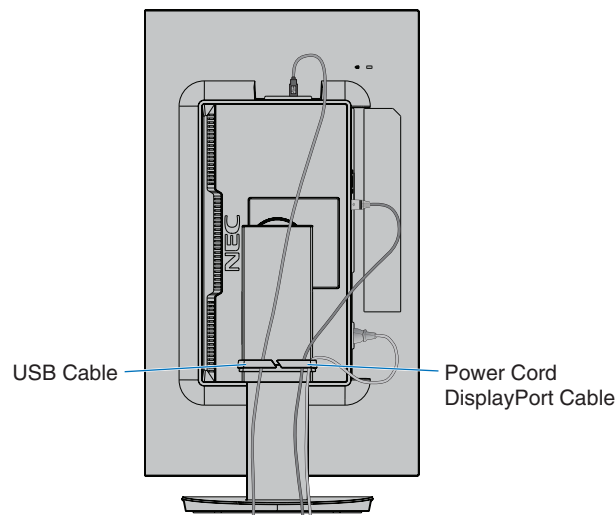

Figure C.4

7. Connect the power cord to the power outlet.

NOTE: Please refer to the **CAUTION** section of this manual for proper selection of the AC power cord.

8. Turn on the monitor by touching the power key on the front bezel and then turn on the computer (**Figure E.1**).

NOTE: If you have any problems, please refer to the **Troubleshooting** section of this User's Manual.

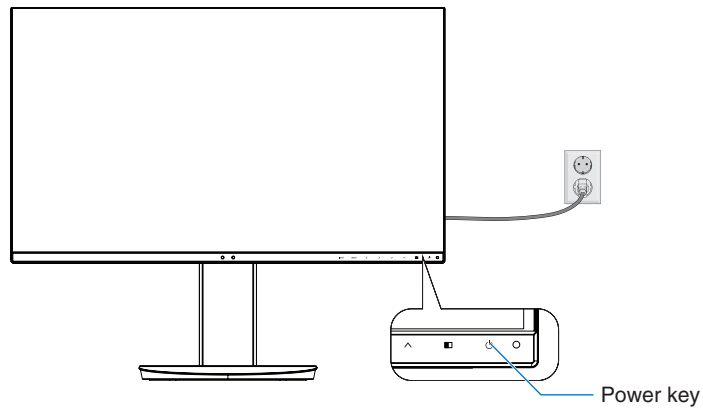

Figure E.1

Adjustable stand with pivot capability

Raise and Lower: Hold the monitor on each side and lift or lower to the desired height.

Tilt and Swivel: Hold the top and bottom sides of the monitor screen with your hands and adjust the tilt and swivel as desired.

Screen Rotation (Pivot): Hold the monitor on each side and turn it from landscape to portrait.

You can adjust the OSD (On-Screen Display) menu rotation to match the screen rotation. Refer to the OSD ROTATION instructions (see [page 20](#)).

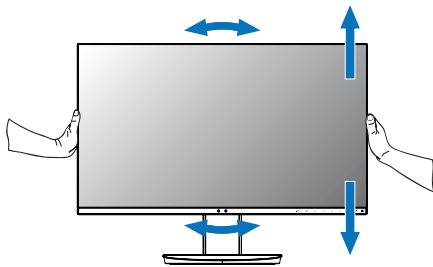

Rotation, Raise and Lower

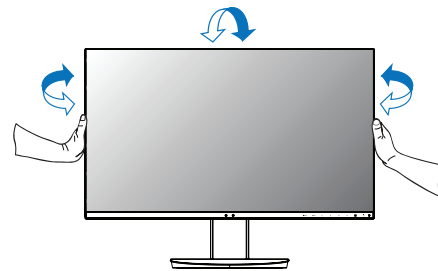

Tilt and Swivel

⚠ CAUTION: Handle with care when adjusting the monitor screen. Do not apply pressure to the LCD when adjusting the height and rotating the monitor screen.
Before rotating, disconnect the power cord and all cables from the display. The screen must be raised to the highest level and tilt to avoid knocking the screen on the desk or pinching your fingers.

Flexible Arm Installation

This LCD monitor is designed for use with a flexible arm. Contact NEC for more information.

To prepare the monitor for alternate mounting purposes:

- Follow the instructions provided by the manufacturer of the display mount.
 - ▲ **CAUTION:** To meet the safety requirements, the monitor must be mounted to an arm that supports the weight of the monitor. See the [Specifications](#) page for details. Remove the monitor stand before mounting.

Remove Monitor Stand for Mounting

To prepare the monitor for alternate mounting purposes:

1. Disconnect all cables.
2. Place your hands on each side of the monitor screen and lift up to the highest position.
3. Place the monitor face down on a non-abrasive surface (**Figure S.1**).
4. Place one hand around the base and one hand on the Quick Release Lever. Push and hold the Quick Release Lever in the direction indicated by the arrow (**Figure S.1**).
5. Lift up the stand to unhook it from the monitor (**Figure S.1**). The monitor can now be mounted using an alternate method. Reverse the process to reattach stand.

NOTE: Handle with care when removing the monitor stand.

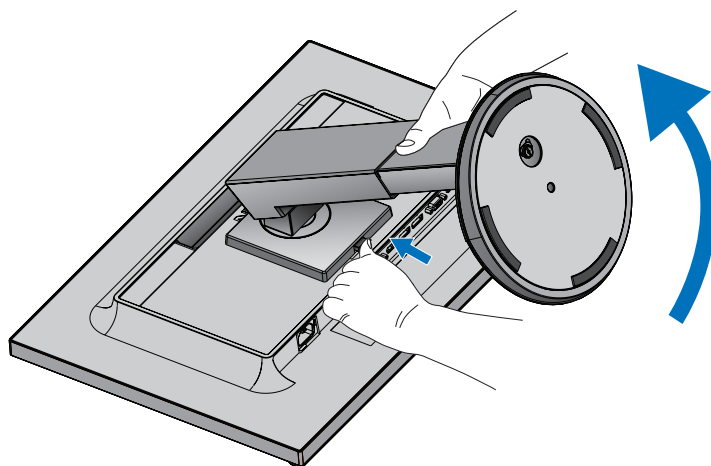

Figure S.1

Mount Flexible Arm

This LCD monitor is designed for use with a flexible arm.

1. Follow the instructions in how to **Remove Monitor Stand for Mounting**.
2. Using 4 screws that meet the specifications listed below, attach the arm to the monitor (**Figure F.1**).

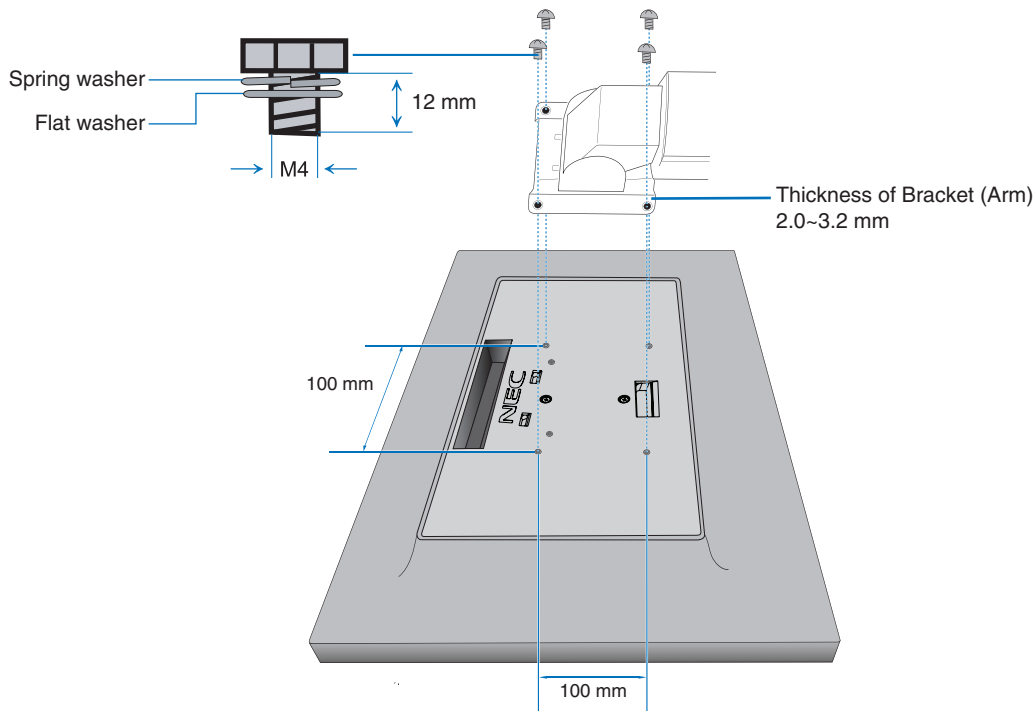

Figure F.1

- ⚠ CAUTION:**
- Only use 4 M4 sized screws when mounting to avoid damage to the monitor and stand.
 - To fulfill the safety requirements, the monitor must be mounted to an arm, which guarantees the necessary stability under consideration for the weight of the monitor. The LCD monitor should only be used with an approved arm (e.g. TUEV GS mark).
 - Tighten all screws (recommended Fasten Force: 98 - 137N•cm).
A loose screw may cause the monitor to fall off the arm.
 - Attaching the flexible arm should be done by two or more people if the monitor cannot be placed face down on a flat surface for installation.

ControlSync

ControlSync simultaneously controls all sub monitors connected to a master monitor. It can also individually control a single sub monitor using the INDIVIDUAL ADJUST function (see [page 22](#)).

Controlling all connected sub monitors (Synchronized control):

- Connect a ControlSync cable (ø 2.5) to the master monitor's ControlSync OUT port and into a sub monitor's ControlSync IN port. Up to 8 monitors can be daisy-chained together by connecting the monitors to each other via the ControlSync OUT to IN ports on the monitors.
- Follow the steps for DATA COPY (see [page 21](#)). When a setting for the master monitor is adjusted, it will be copied and sent to the connected sub monitor(s) automatically.

NOTE: The ControlSync icon will appear on the upper left of the OSD menu in the sub monitors. Do not connect the ControlSync ports IN-to-IN or OUT-to-OUT. The monitors' ControlSync ports must be connected OUT-to-IN.

Do not make a "loop" connection by connecting the last monitor in the chain back to the master monitor.

Turn off the power and disconnect the power cables for all monitors. Connect the ControlSync cables, then connect the power cables, and then turn on the power for each monitor.

If the monitors' video connections are also daisy-chained together via DisplayPort cables, please connect the master monitor to the computer.

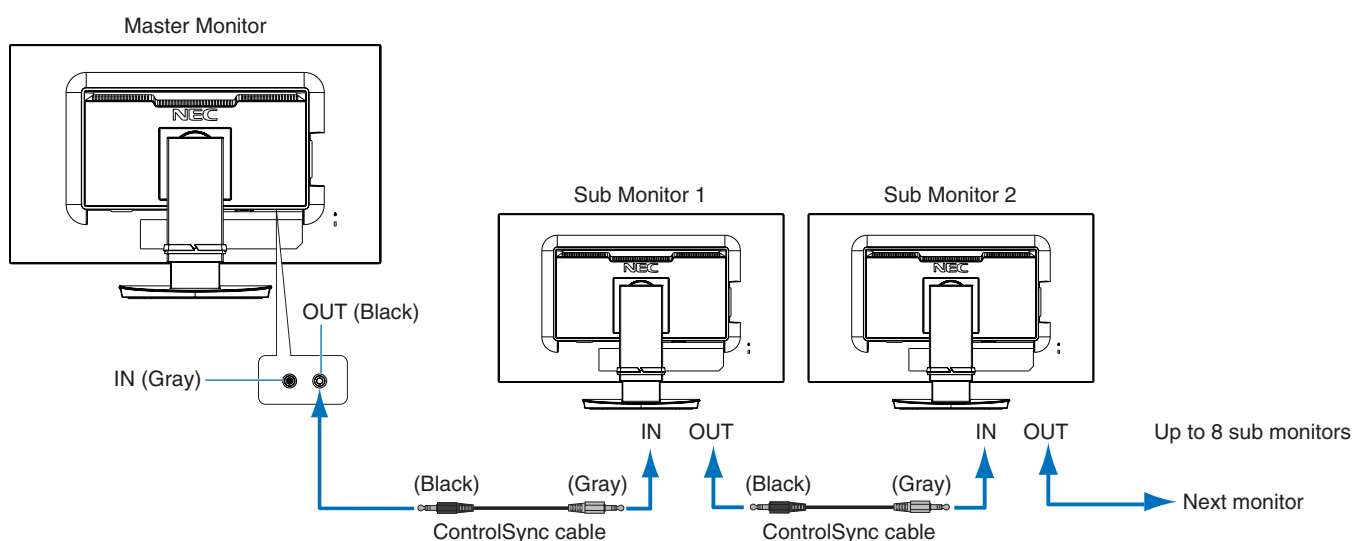
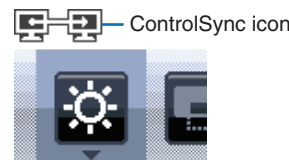

Controlling a target monitor (Individual Adjust)

1. Touch the MENU/EXIT key to show the OSD menu on the master monitor.
2. Touch the DOWN/UP key to select TARGET MONITOR NO. When the cursor is on "TARGET MONITOR NO.," a sub monitor number menu opens. Use the LEFT/RIGHT keys to select the sub monitor number. If you touch the INPUT/SELECT key, each sub monitor displays its monitor number.

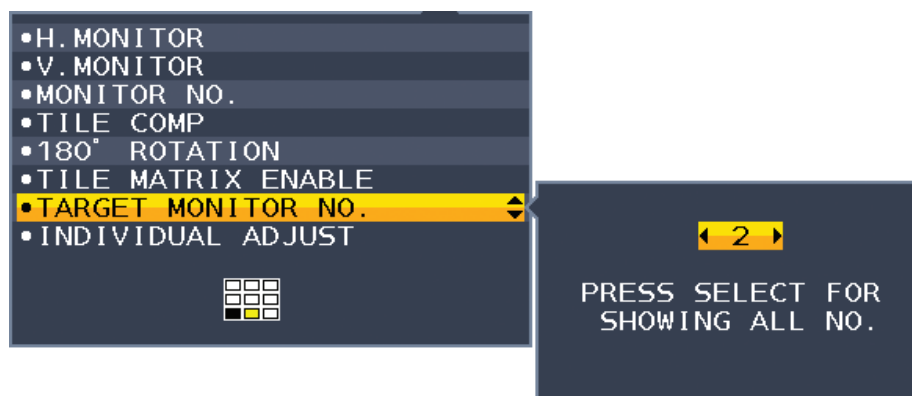

3. Touch the DOWN/UP key to select INDIVIDUAL ADJUST and then set it to ON. Control the sub monitor's OSD using the master monitor's control keys.

NOTE: To disable INDIVIDUAL ADJUST, touch the SELECT and EXIT keys simultaneously.

The following settings can be controlled by ControlSync:

		Synchronized control	Individual adjust
ECO TOOLS	BRIGHTNESS*	Yes	Yes
	CONTRAST	No	Yes
	ECO MODE	Yes	Yes
	AUTO BRIGHTNESS	Yes	Yes
	BLACK LEVEL	No	Yes
	OFF MODE SETTING	Yes	Yes
	OFF MODE SENSOR SETTING	Yes	Yes
	OFF MODE START TIME	Yes	Yes
	HUMAN SENSING	Yes	Yes
	HUMAN SENSOR SETTING	Yes	Yes
	HUMAN SENSOR START TIME	Yes	Yes
DV MODE	Yes	Yes	
SCREEN	LEFT/RIGHT	No	Yes
	DOWN/UP	No	Yes
	H.RESOLUTION	No	Yes
	V.RESOLUTION	No	Yes
	VIDEO LEVEL	No	Yes
	OVER SCAN	No	Yes
	EXPANSION	Yes	Yes
	RESPONSE IMPROVE	No	Yes
	UNIFORMITY	No	Yes
	SHARPNESS	No	Yes
	COLOR	PICTURE MODE	No
WHITE		No	Yes
ADJUST		No	Yes
TOOLS	VOLUME	Yes	Yes
	SOUND INPUT	No	Yes
	VIDEO DETECT	No	Yes
	DP OUT MULTISTREAM	No	Yes
	MULTI PICTURE	No	Yes
	PICTURE PATTERN	No	Yes
	PICTURE SIZE	No	Yes
	PICTURE POSITION	No	Yes
	OFF TIMER	Yes	Yes
	POWER SAVE TIMER	No	Yes
	LED BRIGHTNESS	Yes	Yes
	DDC/CI	Yes	Yes
	USB FUNCTIONALITY	No	Yes
	USB SELECTION	No	Yes
FACTORY PRESET	No	Yes	
MENU TOOLS	LANGUAGE	Yes	Yes
	OSD TURN OFF	Yes	Yes
	OSD LOCK OUT	Yes	Yes
	OSD ROTATION	No	Yes
	HOT KEY	Yes	Yes
	SIGNAL INFORMATION	Yes	Yes
	SENSOR INFORMATION	Yes	Yes
	KEY GUIDE	Yes	Yes
	DATA COPY	No	No
	CUSTOMIZE SETTING	No	Yes
MULTI DISPLAY	H.MONITOR	No	Yes
	V.MONITOR	No	Yes
	MONITOR NO.	No	No
	TILE COMP	Yes	Yes
	180° ROTATE	No	Yes
	TILE MATRIX ENABLE	Yes	Yes
	TARGET MONITOR NO.	No	No
	INDIVIDUAL ADJUST	No	No
ECO INFORMATION	CARBON SAVINGS	No	No
	CARBON USAGE	No	No
	COST SAVINGS	No	No
	CARBON CONVERT SETTING	Yes	Yes
	CURRENCY SETTING	Yes	Yes
	CURRENCY CONVERT SETTING	Yes	Yes

Other settings:

- Power Control (DC switch)
- Ambient Light Sensor
- Human Sensor Result
- Audio Mute

NOTE: Only the master monitor's human sensor and ambient light sensor are active. Please do not cover these sensors (See [page 14](#)).
 After connecting all power cables and ControlSync cables, check that ControlSync operates correctly by turning the master monitor's power off then back on.
 Do not use the ControlSync connectors for any purpose other than specified.

* This value is not a directly adjusted output value. This is adjusted relatively.

Multiple monitors connection using DisplayPort

You can daisy-chain monitors to each other using the DisplayPort OUT/IN connections on the monitors. For using connected monitors in MST (multi-stream transport) mode, the setting should be DP OUT MULTISTREAM "AUTO" for each monitor. Please change the setting for the monitor that connects to the computer last. If the monitors do not display an image, turn off the monitor connected to the computer then turn it back on. Configuring the DisplayPort connections may be necessary. Please refer to the table below and change the settings as needed.

OSD (See page 18)	
DP OUT MULTISTREAM "CLONE"	Factory setting. DisplayPort 1.1a setting with: – SST (single-stream transport).
DP OUT MULTISTREAM "AUTO"	DisplayPort 1.2 setting with: – SST (single-stream transport) and MST (multi-stream transport).

Depending on the display adapter settings in the operating system for the connected computer, the image may not extend. Please refer to the user instructions for the computer to change the settings.

NOTE: Use the DisplayPort cables included with the monitors to connect the monitors to each other. We strongly recommend using the same monitor model for all monitors in the connected daisy-chain. Remove the cap from the DisplayPort OUT connector on the monitor. Please contact your display adapter supplier for detailed information.

	BIT RATE	Maximum number of connectable monitors
MST (multi-stream transport)	HBR2 (Default setting)	2 units (HDCP contents: 2 units)
	HBR	1 unit (HDCP contents: 1 unit)

NOTE: The number of monitors that can daisy-chain, from a single connection to the computer, depends on the display adapter capabilities and its settings. Please refer to the user instructions for the computer or display adapter.

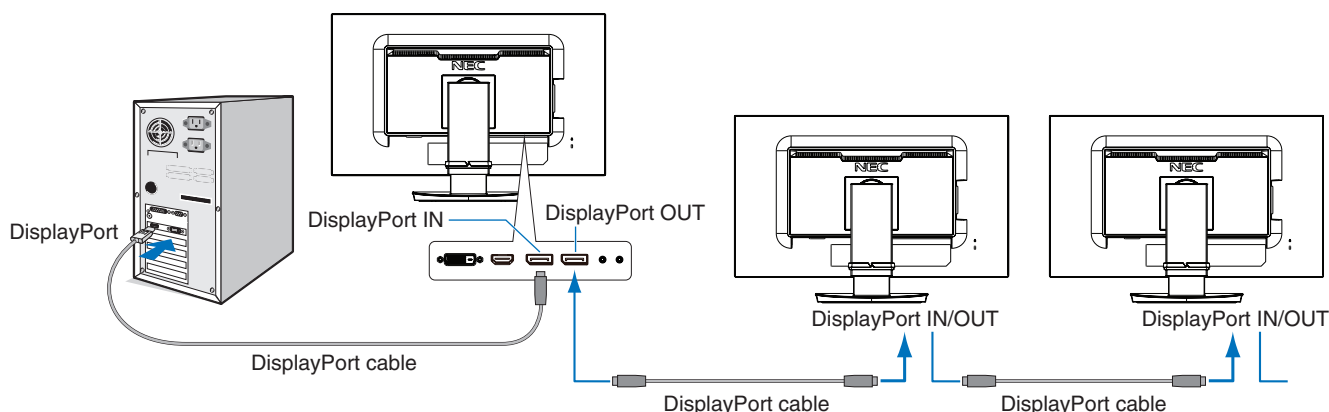

NOTE: When the monitor has no image, follow the troubleshooting step **Recovering from no image** and select DP VER "1.1" (below). When set the MST function is selected, the power management function according to the ErP directive doesn't work.

Recovering from no image

If the monitors do not display an image after configuring DP OUT MULTISTREAM, please follow the instructions below:

1. Turn off the computer.
2. Touch the "MENU" key to show the No Signal OSD menu.
3. Touch the "Λ" key to show the VIDEO INPUT menu.
4. Touch "Λ" or "∨" to show the DisplayPort switch menu.
5. Select DP VER "1.1" to switch the DisplayPort setting.
6. Touch MENU to close the OSD menu.
7. Turn on the computer.

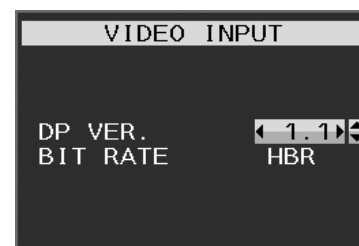

NOTE: MST (multi-stream transport) and SST (single-stream transport) requires a corresponding display adapter. Check to make sure that the display adapter supports MST (multi-stream transport). Please refer to the user instructions for the computer to change the settings.

NOTE: Use the DisplayPort cables included with the monitors to connect the monitors to each other.

Controls

OSD (On-Screen Display) control keys on the front of the monitor function as follows:

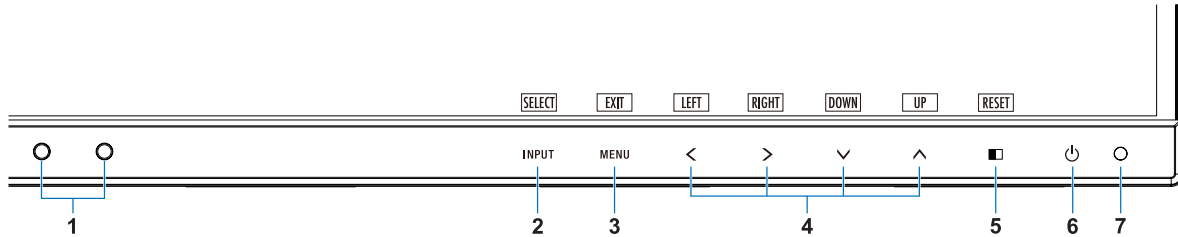

1 Ambient Light Sensor Human Sensor	Detects the level of ambient lighting and the presence of a user, allowing the monitor to make adjustments to various settings resulting in a more comfortable viewing experience. Do not cover this sensor.
2 INPUT/SELECT	Changes the input source when not in the OSD menu. Enters sub menus when in the OSD menu. You can directly change to L/B (LOW BLUE LIGHT) mode by touching the INPUT key for 3 seconds or more.
3 MENU/EXIT	Opens the OSD menu. Exits the OSD sub menus and main menu.
4 LEFT/RIGHT/ UP/DOWN*2	Navigates through the OSD menu. When the OSD menu is off, touch one of the following keys to open the menu for the function indicated:*1 UP key: BRIGHTNESS DOWN key: VOLUME RIGHT key: USB SELECTION
5 ■ /RESET	When the OSD menu is displayed on the screen, this button works as a reset command for the OSD settings. When the OSD menu is not displayed on the screen, this button works as a select function for the MULTI PICTURE settings.*3 You can swap pictures between a main screen and a sub screen by touching the ■ /RESET key for 3 seconds or more while Main or Sub is set in MULTI PICTURE.*1, *4
6 Power	Turns the monitor on and off.
7 Power LED	Indicates that the power is on or off.

*1 When the Hot Key function is OFF, this function is disabled.

*2 Depending on the OSD ROTATION setting, LEFT, RIGHT, UP and DOWN key guides are displayed at the <, >, v, ^ keys differently (See [page 20](#)).

*3 MULTI PICTURE menu.

Touch the LEFT/RIGHT to select a priority (adjustable) screen. When MULTI PICTURE is OFF, a single screen will be displayed.



*4 Swapping of picture by picture is not supported. The sound keeps the value of SOUND INPUT setting. The expansion keeps the values of EXPANSION setting of each input.



ECO TOOLS

BRIGHTNESS

Adjusts the overall image and background screen brightness.
If ECO MODE is set to 1 or 2, a bar for CARBON FOOTPRINT will appear.

CONTRAST

Adjusts the overall image and background screen brightness by input signal level.

NOTE: CONTRAST and DV MODE can be adjusted for all COLOR CONTROLS except L/B.

ECO MODE

Decreases the amount of power consumption by reducing the brightness level.

OFF: Does not function.

1: Sets the brightness variable range from 0% to 70%.

This setting can adjust brightness to a range in which power is reduced by 10% compared to the maximum brightness setting.

2: Sets the brightness variable range from 0% to 30%.

This setting can adjust brightness to a range in which power is reduced by 30% compared to the maximum brightness setting.

When this function is set to ON, a CARBON FOOTPRINT bar will appear alongside the brightness adjustment bar.

NOTE: This function is disabled when DV MODE is set to DYNAMIC.

This function is disabled when Color Control System is set to DICOM SIM.

This function works only when MULTI PICTURE is off.

AUTO BRIGHTNESS

OFF: Does not function.

ON (AMBIENT LIGHT): Automatically adjusts the brightness to the optimal setting by detecting the brightness level of the environment*1.

*1: Please refer to [page 33](#) for full "Auto Brightness" information.

NOTE: This function is disabled when DV MODE is set to DYNAMIC.

This function is disabled when Color Control System is set to DICOM SIM.

This function works only when MULTI PICTURE is off.

BLACK LEVEL

Adjusts the brightness level of black when displayed on screen.

OFF MODE SETTING

The Intelligent Power Manager allows the monitor to enter into power saving mode after a period of inactivity.

The OFF MODE has two settings:

OFF: The monitor enters into power saving mode automatically when the input signal is lost.

ON: The monitor enters into power saving mode automatically when the amount of surrounding light goes below the level determined by you. The level can be adjusted in the OFF MODE sensor setting.

When in power saving mode, the LED on the front of the monitor becomes dark blue. When in power saving mode, touch any of the front keys, except for POWER and INPUT/SELECT key, to return to normal mode.

When the amount of surrounding light returns to normal levels, the monitor will automatically return to normal mode.

SENSOR SETTING (OFF MODE SETTING)

Adjusts the threshold level for the ambient light sensor for detecting low light conditions and shows the current sensor measurement result.

START TIME (OFF MODE SETTING)

Adjusts the wait time to enter into to a lower power consumption level when the ambient light sensor detects low light conditions.

HUMAN SENSING

The sensor detects the movement of a person by using the HUMAN SENSING function. The HUMAN SENSING function has three settings:

OFF: Does not function.

1 (LIGHT): After it detects that there is no person after a period of time, the monitor shifts to low brightness mode automatically to reduce the power consumption. When a person comes near the monitor again, the monitor will automatically return to normal mode. START TIME adjusts the wait time before entering the low brightness mode.

2 (DEEP): After it detects that there is no person, the monitor shifts to power saving mode automatically to reduce the power consumption. When a person comes near the monitor again, it resumes from the power saving mode.

NOTE: Detects a person within about 1.5 m from the monitor.

SENSOR SETTING (HUMAN SENSING)

Adjusts the threshold level of human sensing.

When the human icon is located on the right side of the white color bar or vermilion color wave, a person is not detected.

NOTE: The human sensing function starts after the OSD menu is closed.

START TIME (HUMAN SENSING)

Adjusts the wait time before entering to low brightness mode or power saving mode when Human Sensor detects no person.

DV MODE

Dynamic Visual Mode allows you to select from the following settings:

STANDARD: Standard setting.

TEXT: Setting that makes letters and lines crisp; best suited for basic word processing and spreadsheets.

MOVIE: Setting that boosts dark tones; best suited for movies.

GAMING: Setting that boosts whole tones; best suited for games that use vivid, colorful images.

PHOTO: Setting that optimizes contrast; best suited for still images.

DYNAMIC: Setting that adjusts the brightness by detecting the screen's black areas and optimizes it.

NOTE: This function is disabled when Color Control System is set to L/B, PROGRAMMABLE or DICOM SIM.
STANDARD is used for TCO Certificate compliance.
DYNAMIC works only when MULTI PICTURE is off.



SCREEN

LEFT / RIGHT

Controls horizontal image position within the display area of the LCD.

NOTE: If this function does not work correctly, reduce the H. RESOLUTION level.

DOWN / UP

Controls vertical image position within the display area of the LCD.

NOTE: If this function does not work correctly, reduce the V. RESOLUTION level.

H.RESOLUTION

Adjusts the horizontal size by increasing or decreasing the resolution.

Touch the "RIGHT" key to reduce the width of the image on the screen.

Touch the "LEFT" key to expand the width of the image on the screen.

V.RESOLUTION

Adjusts the vertical size by increasing or decreasing the resolution.

Touch the "RIGHT" key to reduce the height of the image on the screen.

Touch the "LEFT" key to expand the height of the image on the screen.

VIDEO LEVEL (HDMI input only)

NORMAL: Setting for use with a computer. Displays all input signals of 0-255 steps.

EXPAND: Setting for use with audio visual equipment. Expands input signals of 16-235 steps to 0-255 steps.

OVER SCAN (HDMI input only)

Some video formats may require different scanning modes in order to best display the image.

ON: Image size is larger than what can be displayed. The image edge will appear cropped. Approximately 95% of the image will be shown on the screen.

OFF: Image size stays within the display area. The whole image is displayed on the screen.

EXPANSION

Sets the Zoom method.

FULL: The image is expanded to full screen regardless of the resolution.

ASPECT: The image is expanded without changing the aspect ratio.

OFF: The image is not expanded.

NOTE: FULL does not work when MULTI PICTURE is OFF.

RESPONSE IMPROVE

Turns the Response Improve function on or off. Response Improve may reduce blurring that occurs in some moving images.

UNIFORMITY

This function electronically compensates for the slight variations in the white uniformity level as well as for deviations in color that may occur throughout the display area of the screen. These variations are characteristic of LCD panel technology. This function improves the color and evens out the luminance uniformity of the display.

NOTE: Using the UNIFORMITY feature does reduce the overall peak luminance of the display. If greater luminance is desired over the uniform performance of the display, then UNIFORMITY should be turned off. "ON" produces a better effect, but may also reduce the CONTRAST RATIO.

SHARPNESS

Adjusts the crispness of the image.



Color

PICTURE MODE

Select the Picture mode that is most suitable for the type of content that is shown. You can change up to 5 types. See "Using the PICTURE MODE function" ([page 24](#)) for more information.

WHITE

Adjust the color temperature by NATIVE or increasing or decreasing this setting. A lower color temperature will make the screen reddish and a higher color temperature will make the screen bluish. NATIVE is a default color temperature of LCD panel. 6500K is recommended for general graphic design and 5000K is recommended for print matching.

NOTE: It is automatically set to NATIVE when decreasing WHITE level below 3000K.

ADJUST

WHITE (White Balance): If WHITE needs further adjustment, the individual R/G/B levels of the white point can be adjusted. To adjust the R/G/B levels, CUSTOM must be showing as the color temperature selection.

HUE: Adjusts the hue of each color*¹. The change in color will appear on screen and the menu color bars will show the amount of adjustment.

OFFSET: Adjusts the color brightness of each color*¹. Touch the "RIGHT" key to increase the color brightness.

SATURATION: Adjusts the color depth of each color*¹. Touch the "RIGHT" key to increase the color vividness.

*1: RED, YELLOW, GREEN, CYAN, BLUE and MAGENTA.



Tools

VOLUME

Controls the volume of the speakers or headphones.
To mute the speaker output touch the “/RESET” key.

SOUND INPUT

Selects audio source.

When MULTI PICTURE is OFF:

This function selects AUDIO INPUT, HDMI, DISPLAYPORT or USB-C.

When MULTI PICTURE is LEFT or RIGHT:

LEFT: Outputs the audio that is associated with the left video signal (HDMI, DISPLAYPORT or USB-C only).

RIGHT: Outputs the audio that is associated with the right video signal (HDMI, DISPLAYPORT or USB-C only).

AUDIO INPUT: Outputs the audio from the input audio jack on the back of the monitor.

When MULTI PICTURE is MAIN or SUB:

MAIN: Outputs the audio that is associated with the main video signal (HDMI, DISPLAYPORT or USB-C only).

SUB: Outputs the audio that is associated with the sub video signal (HDMI, DISPLAYPORT or USB-C only).

AUDIO INPUT: Outputs the audio from the input audio jack on the back of the monitor.

NOTE: When using split screen, the SOUND INPUT setting can change which audio input signal is routed through the built-in speakers.

VIDEO DETECT

Selects the method of video detection when more than one video input is connected.

FIRST: When the current video input signal is not present, the monitor searches for a video signal from the other video input ports. If the video signal is present in another port, the monitor switches the video source input to the detected video source automatically. The monitor will not look for other video signals while the current video source is present.

NONE: Video input signal detection is not enabled.

LAST: When the monitor is displaying a signal from the current source and a new secondary source is supplied to the monitor, the monitor will automatically switch to the new video source. When the current video input signal is not present, the monitor searches for a video signal from the other video input ports. If the video signal is present in another port, the monitor switches the video source input port to the detected video source automatically.

DP OUT MULTISTREAM

Selects the DisplayPort mode.

CLONE: Sets SST (single-stream transport). Default is “CLONE”.

AUTO: Displays in SST (single-stream transport) or MST (multi-stream transport) mode. “AUTO” should be selected when using MST (multi-stream transport).*





If multiple monitors are set to SST (single-stream transport), an individual image is displayed at each monitor.

NOTE: When the monitor has no image, refer to **Multiple monitors connection using DisplayPort** (see [page 13](#)).

*: MST (multi-stream transport) and SST (single-stream transport) require the computer display adapter supports the feature. Please refer to the user instructions for the computer or display adapter.

MULTI PICTURE

Activates the MULTI PICTURE function and selects the priority (adjustable) screen.

Icon	Name	
	Off	Multi Picture is Off.
	Left	2 split screen (Picture by Picture). Left hand side screen is selected.
	Right	2 split screen (Picture by Picture). Right hand side screen is selected.
	Main	Picture in Picture. Main screen is selected.
	Sub	Picture in Picture. Sub screen is selected.

NOTE: When “Left”, “Right”, “Main” or “Sub” is selected, only the selected screen can be adjusted.

PICTURE PATTERN

When “Left” or “Right” is selected in MUTI PICTURE, this selects the size of the picture.

AUTO: Shows 2 screens based on the INPUT RESOLUTION and EXPANSION settings for the priority (adjustable) screen selected in MULTI PICTURE.

CENTER: Splits 2 screens divided evenly from the center.

When “Main” or “Sub” is selected in MUTI PICTURE, this selects the position of the sub screen.

LEFT: The sub screen’s start position is bottom-left side of the screen.

RIGHT: The sub screen’s start position is bottom-right side of the screen.

PICTURE SIZE

Selects SMALL, MIDDLE or LARGE for the size of the sub-picture used in Picture in Picture mode.

PICTURE POSITION

Determines where the sub screen appears on the screen.

Touch the SELECT key to enter the PICTURE POSITION mode (**Figure 1**).

Using LEFT, RIGHT, UP and DOWN keys controls the horizontal and vertical position of the sub screen within the boundaries of the side where the sub screen is located (**Figure 2**).

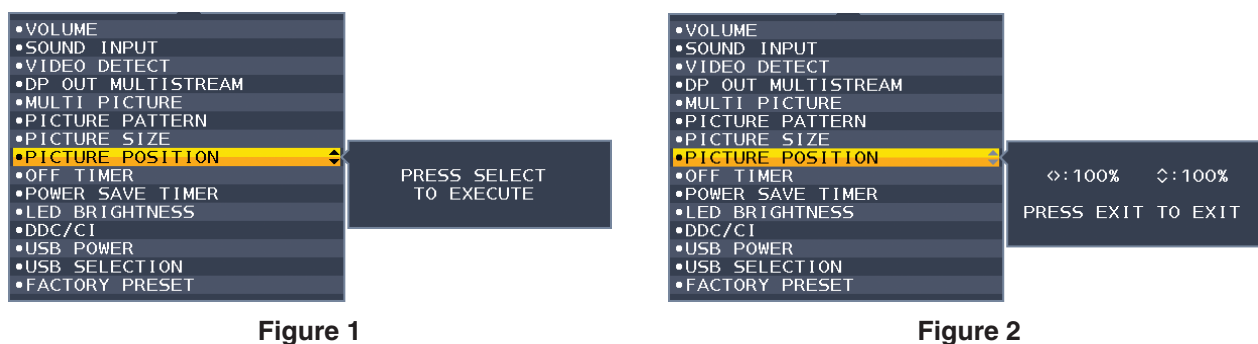

Figure 1

Figure 2

OFF TIMER

The monitor will automatically power off after a period of time has passed, which you can set.

Before powering off, a message will appear on the screen asking if you want to delay the turn off time by 60 minutes. Touch any OSD key to delay the power-down time.

POWER SAVE TIMER

POWER SAVE TIMER allows the monitor to turn off automatically after 2 consecutive hours in power save mode.

LED BRIGHTNESS

Adjusts the blue LED brightness.

DDC/CI

This function turns the DDC/CI function ON or OFF.

USB FUNCTIONALITY

Selects how power through the USB type A port and USB type C port is enabled in relation to the Monitor’s power status.

AUTO: Power is supplied to the USB downstream port depending on the monitor’s power condition.

ON: Power is always supplied to the USB downstream port even when the monitor is in power save mode or power OFF.

OFF: All USB functions (include USB Type-C video signal) are disabled.

NOTE: Actual power consumption depends on the connected USB device even when the monitor’s power is off.

USB SELECTION

Change the USB upstream input (USB or USB-C) associated with the current display input. When connecting a computer to each of the upstream ports, the monitor’s USB downstream ports can be used by selecting this setting for the current input signal.

You can change the active display and upstream USB port combination by using the Input key (see [page 14](#)).

When using only one upstream port, the connected upstream port is used by default.

NOTE: To avoid data loss, before changing USB upstream ports, ensure that no USB storage devices are in use by the operating system of the computer attached to the USB upstream port.

FACTORY PRESET

Selecting Factory Preset allows you to reset all OSD control settings back to the factory settings except Language, OSD Lock Out and items in Multi Display tag. Individual settings can be reset by touching the “/RESET” key.



MENU Tools

LANGUAGE

Selects the language used by the OSD.

OSD TURN OFF

The OSD menu will stay on as long as it is in use. You can select how long the monitor waits after the last key touch to shut off the OSD menu. The preset choices are 10-120 seconds by 5-second increments.

OSD LOCK OUT

This control completely locks out access to all OSD control functions except for Brightness, Contrast and Volume.

To activate the OSD Lock Out function, enter the OSD menu, select OSD LOCK OUT, then touch “SELECT” and RIGHT simultaneously. To deactivate, touch “SELECT” and LEFT simultaneously.

OSD ROTATION

This controls the OSD menu rotation.

Depending on the image angle (monitor rotation), select a suitable OSD rotation setting.

NOTE: Please set the KEY GUIDE to “ON” to display the key guide.

Setting (Angle)	Image	Key guide
0		<: LEFT >: RIGHT ∨: DOWN ∧: UP
90		
180		
270		

HOT KEY



When this function is ON, BRIGHTNESS, VOLUME, USB SELECTION and MULTI PICTURE settings can be changed without entering the OSD menu.

ON:

BRIGHTNESS: Touch the UP key, then adjust the brightness level in the sub menu that opens.

VOLUME: Touch the DOWN key, then adjust the volume level in the sub menu that opens.

USB SELECTION: Touch the RIGHT key to open the USB SELECTION sub menu.

MULTI PICTURE: Touch the  /RESET key to open the MULTI PICTURE sub menu. You can swap pictures between a main screen and a sub screen by touching the  /RESET key for 3 seconds or more while Main or Sub is set in MULTI PICTURE.

OFF: The HOT KEY function for the “ /RESET” key, “LEFT/RIGHT” key and “DOWN/UP” key functions are disabled.

SIGNAL INFORMATION

If you select “ON”, the monitor displays “VIDEO INPUT MENU” after changing the input.

If you select “OFF”, the monitor doesn’t display “VIDEO INPUT MENU” after changing the input.

SENSOR INFORMATION

If you select “ON”, the monitor displays a “HUMAN SENSOR ON” message. If you select “OFF”, the monitor doesn’t display the “HUMAN SENSOR ON” message.

KEY GUIDE

If you select “ON”, the Key Guide appears on screen when the OSD menu is accessed.

DATA COPY

To initiate data copy from the master monitor to the sub monitor(s), select “DATA COPY” and touch “SELECT”. A “PROCEEDING...” indicator will appear on the screen.

NOTE: This function is only intended for the master monitor in ControlSync.

All of the settings specified in the ControlSync chart (see [page 12](#)) will be copied from the master monitor to the sub monitor(s).

CUSTOMIZE SETTING

Store the current settings for easy recovery.

To store current settings: Touch “SELECT”. After a warning message appears, touch “RESET” and the current settings are stored.

To restore settings: Hold “MENU” for 3 seconds or more while the OSD menu is off.



MULTI DISPLAY

H MONITOR

Selects the number of horizontal displays.

V MONITOR

Selects the number of vertical displays.

MONITOR NO.

This function is for image expansion with multi screen but also used for INDIVIDUAL ADJUST.

Image expansion with multi screen:

To set the monitor number to each monitors, please refer to “[Example of installation and monitor number](#)”. When H.MONITOR and V.MONITOR are set, an assumed installation figure is shown under the OSD menu. When you set monitor number to a monitor, please install the monitor at the same spot where assumed installation figure is shown as black.

Control a sub monitor from the master monitor by INDIVIDUAL ADJUST:

This function is for controlling a sub monitor from the master monitor. It is useful if the sub monitor is located at an unreachable spot.

Please set the monitor number for each monitor. If you set a unique number to each of the monitors, you can control a specific monitor. If you set duplicate numbers to some of the monitors, you can control the monitors that have the same number simultaneously.

NOTE: A master monitor should be connected only with ControlSync OUT. Do not connect a master monitor with ControlSync IN. For information about master and sub monitors, see ControlSync ([page 11](#)).



Sets master monitor to 1 then sets the other monitors (sub monitors) by following below order.

Example of installation and monitor number

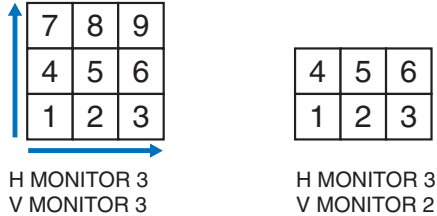

TILE COMP

Works in tandem with TILE MATRIX to compensate for the width of the tile bezels in order to accurately display the image.

TILE COMP with 4 monitors (black area shows monitor frames):

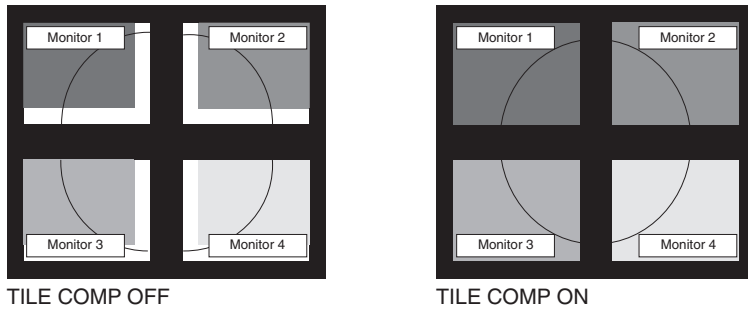

180° ROTATE

Rotates the image.

NOTE: When installing monitors in two stages, upper monitors can be installed upside down.

The installation method can minimize bezel distance between upper monitors and bottom monitors.



TILE MATRIX ENABLE

Allows one image to be displayed over multiple screens. This feature can be used with up to 9 monitors (3 vertical and 3 horizontal). Using TILE MATRIX ENABLE requires the PC output signal be sent through a distribution amplifier to each individual monitor.

TARGET MONITOR NO.

Controls a sub monitor's OSD by using the master monitor's control keys.

Sets the sub monitor number that is set at MONITOR NO. By touching the INPUT (SELECT) key, each sub monitor displays its monitor number.

INDIVIDUAL ADJUST

ON: Controls an individual sub monitor from the master monitor.

Once ON is set, operation at the master monitor reflects to the sub monitor OSD.

To disable INDIVIDUAL ADJUST, please touch SELECT and EXIT keys simultaneously.

NOTE: Please connect monitors with the ControlSync cables.



ECO Information

CARBON SAVINGS: Displays the estimated carbon savings information in kg.

CARBON USAGE: Displays the estimated carbon usage information in kg. This is the arithmetic estimation, not actual measurement value.

COST SAVINGS: Displays the electricity cost savings in balance.

CARBON CONVERT SETTING: Adjusts the carbon footprint factor in the carbon saving calculation. This initial setting is based on the OECD (2008 Edition).

CURRENCY SETTING: Displays electricity pricing in 6 currency units.

CURRENCY CONVERT SETTING: Displays electricity savings in kW/hour (US Currency is default).

NOTE: This model's initial setting is "Currency = US\$" and its Currency Convert setting = \$0.11.

This setting can be changed by using the ECO information menu.

If you want to use the French setting, please refer to the steps below:

1. Touch the Menu key and select the ECO information menu using the "LEFT" or "RIGHT" key.
2. Select the CURRENCY SETTING item by touching the "UP" or "DOWN" key.
3. The French currency unit is Euro (€). You can adjust currency setting to Euro icon (€) from US dollar (\$) by touching the "LEFT" or "RIGHT" key in Current setting item.
4. Select CURRENCY CONVERT SETTING by touching the "UP" or "DOWN" key*.
5. Adjust CURRENCY CONVERT SETTING by touching the "LEFT" or "RIGHT" key.

* This initial Euro (€) setting is based on the OECD data for Germany (2007 Edition).

Please check the receipt of electricity prices for France or OECD data for France.

The French value according to the OECD data (2007 Edition) was €0.12.



Information

Provides information about the current display resolution and technical data. Indicates the model and serial numbers of your monitor.

OSD Warning

OSD warning menus disappear when EXIT is selected.

NO SIGNAL: This function gives a warning when there is no horizontal or vertical sync. After power is turned on or when there is a change of input signal, the **No Signal** window will appear.

OUT OF RANGE: This function gives a recommendation of the optimized resolution and refresh rate. After the power is turned on or there is a change of input signal or if the video signal doesn't have proper timing, the **Out Of Range** menu will appear.

Using the PICTURE MODE function

Choose the Picture Mode that is most suitable for the type of content that is shown.
There are several Picture Mode types (FULL, sRGB, Low Blue Light, DICOM SIM., PROGRAMMABLE).

- Each PICTURE MODE includes WHITE, HUE, OFFSET and SATURATION settings.



The type of PRESET

PRESET	PURPOSE
FULL	Native display color gamut. Suitable for use with color managed applications.
sRGB	Standard color space used for the Internet, Windows operating systems and digital cameras. Recommended setting for general color management.
Low Blue Light	Reduces blue light emitted from the monitor.
DICOM SIM.	Medical settings for X-ray imaging view. Setting that conforms to the DICOM simulation for the Grayscale Standard Display Function.
PROGRAMMABLE	For the Hardware Calibration settings by NEC Display Solutions software (some OSD settings are disabled).

Specifications

Monitor Specifications		MultiSync EA271Q	Notes
LCD Module	Diagonal: Viewable Image Size: Native Resolution (Pixel Count):	68.47 cm/27 inches 68.47 cm/27 inches 2560 x 1440	Active matrix; thin film transistor (TFT) liquid crystal display (LCD); 0.233 mm dot pitch; 350 cd/m ² white luminance; 1000:1 contrast ratio (typical), (7000:1 Contrast ratio, Dynamic).
Input Signal			
DisplayPort:	DisplayPort Connector: USB-C Port:	Digital RGB Digital RGB	DisplayPort V1.2 (HDCP1.3) DisplayPort V1.2 (HDCP1.3)
DVI:	DVI-D 24pin:	Digital RGB	DVI (HDCP1.3)
HDMI:	HDMI Connector:	Digital YUV Digital RGB	HDMI (HDCP1.4)
Output Signal			
DisplayPort:	DisplayPort Connector:	Digital RGB	DisplayPort Complies with Standard V1.2, applicable to HDCP
Display Colors		16,777,216	
Synchronization Range	Horizontal: Vertical:	31.5 kHz to 94.0 kHz 56 Hz to 75 Hz	Automatically Automatically
Viewing Angle	Left/Right: Up/Down:	±89° (CR > 10) ±89° (CR > 10)	
Response Time		6 ms (Gray to gray Typ.)	
Active Display Area	Landscape: Horiz.: Vert.: Portrait: Horiz.: Vert.:	596.7 mm/23.5 inches 335.7 mm/13.2 inches 335.7 mm/13.2 inches 596.7 mm/23.5 inches	
USB Hub	I/F: Port: Load Current:	USB Specification Revision USB 3.1 Gen 1 Upstream 2 (incl. 1 x USB-C Port) Downstream 3 Downstream Port: 5V/0.9 A (Max.) USB-C Port: 60 W (Max.)	Upstream port applicable to USB monitor control.
AUDIO			
Audio Input:	STEREO Mini Jack: DisplayPort Connector: HDMI Connector:	Analog Audio Digital Audio Digital Audio	Stereo L/R 500mV rms 20 Kohm PCM 2ch 32, 44.1, 48 kHz (16/20/24bit) PCM 2ch 32, 44.1, 48 kHz (16/20/24bit)
Headphone Output:	STEREO Mini Jack:		Headphone Impedance 32 Ohm
Speakers	Practical Audio Output:	1.0 W + 1.0 W	
ControlSync (available up to 8 sub monitors)	IN: OUT:	Stereo Micro jack 2.5 φ Stereo Micro jack 2.5 φ	
Power Supply		AC 100-240 V, 50/60 Hz	
Current Rating		1.60 - 0.75 A	
Dimensions	Landscape: Portrait:	611.8 mm (W) x 378.0 - 528.0 mm (H) x 250.0 mm (D) 24.1 inches (W) x 14.9 - 20.8 inches (H) x 9.8 inches (D) 361.9 mm (W) x 628.6 - 652.1 mm (H) x 250.0 mm (D) 14.2 inches (W) x 24.7 - 25.7 inches (H) x 9.8 inches (D)	
Stand adjustable range	Height Adjustment: Tilt / Pivot / Swivel:	150 mm/5.9 inches (Landscape orientation) 23.5 mm/0.9 inches (Portrait orientation) Up 35° Down 5° / ± 90° / 340°	
Weight		9.1 kg (20.1 lbs)/Without stand: 5.7 kg (12.6 lbs)	
Environmental Considerations			
	Operating Temperature: Humidity: Altitude:	5°C to 35°C/41°F to 95°F 20% to 80% 0 to 16,404 Feet/0 to 5,000 m	
	Storage Temperature: Humidity: Altitude:	-10°C to 60°C/14°F to 140°F 10% to 85% 0 to 40,000 Feet/0 to 12,192 m	

NOTE: Technical specifications are subject to change without notice.

Major supported timings

Resolution		Vertical Frequency	Notes
H	V		
720	x 400	70 Hz	
640	x 480	60/67/72/75 Hz	
720	x 480	60 Hz	
720	x 576	50 Hz	
800	x 600	56/60/72/75 Hz	
1024	x 768	60/70/75 Hz	
1280	x 720	50/60 Hz	
1280	x 960	60/75 Hz	
1280	x 1024	60/75 Hz	
1440	x 900	60 Hz	
1600	x 1200	60 Hz	
1680	x 1050	60 Hz	
1920	x 1080	50/60 Hz	
2560	x 1440	60 Hz	Recommended

NOTE: When the selected monitor resolution is not a native panel resolution, the text contents appearance in the monitor screen is expanded in a horizontal or vertical direction to show the non-native resolution to full screen. This expansion is done by interpolated resolution technologies, which are normal and widely used in flat panel devices.

Features

USB Type-C With Power Delivery: Supports video & audio input, USB hub function and supplies power to connected devices by a single cable, which provides flexible connectivity and tidy work environment.

3-side Narrow Bezel: Stylish appearance and less distance between adjacent multi-screens.

Fully Ergonomic Stand: Provides viewing flexibility with 150mm height adjustment, -5 ~ 35-degree tilt, 170-degree swivel to both right/left directions with cable management function and small footprint. Monitor head (display part) can touch the stand base for lower position requirement.

ErgoDesign Features: Enhance human ergonomics to improve the working environment, protect the health of the user and save money. In addition to the fully ergonomic stand, examples include OSD controls for quick and easy image adjustment and lower emissions.

VESA Standard Mounting Interface: Allows you to connect your MultiSync monitor to any VESA standard third party mounting arm or bracket.

OSD Rotation: Supports better intuitive OSD operation when the monitor is set in pivot (90/270 degrees) or inverted (180 degrees).

DisplayPort Out: This monitor has a DisplayPort out connector for daisy-chain connection. Multiple monitors can be connected without complicated cable management.

Plug and Play: The Microsoft® solution with the Windows® operating system facilitates setup and installation by allowing the monitor to send its capabilities (such as screen size and resolutions supported) directly to your computer, automatically optimizing display performance.

USB Hub 3.1 Gen.1: The USB hub adds flexibility to your computing by providing easy access to USB SuperSpeed data transfer and charging via USB. For more details, please see [page 7](#).

Picture By Picture/Picture In Picture: Two different input sources can simultaneously be viewed side by side (Picture By Picture) or a small sub screen on a large main screen (Picture In Picture), which increases job productivity.

Hardware Calibration: Adjusts brightness, colors and gamma curve for your preference with software and color sensor.

USB Monitor Control: Allows you to adjust each item through application software by connecting a USB cable.

6-Axis Color Control: In addition to RGB (Red/Green/Blue) colors, CMY (Cyan/Magenta/Yellow) colors can be adjusted for better color reproduction such as matching print images.

UNIFORMITY: This feature compensates for slight variations in the white uniformity level that may occur on the screen and improves the color and evens out the luminance uniformity of the display.

Human/Ambient Sensors: Controls screen brightness according to user presence and ambient light status for less power consumption.

RESPONSE IMPROVE: Improves gray to gray response.

Intelligent Power Manager System: Provides innovative power-saving methods that allow the monitor to shift to a lower power consumption level when on but not in use, saving two-thirds of your monitor energy costs, reducing emissions and lowering the air conditioning costs of the workplace.

ControlSync: Provides control and synchronization of settings for up to eight MultiSync EA series displays from a single master monitor (see [page 11](#)).

INDIVIDUAL ADJUST: A designated main monitor can adjust an individual sub monitor(s) by the OSD. It is good for multi-setting monitors which are positioned far from the user.

TILE MATRIX, TILE COMP: Expands one image over multiple screens with accuracy while compensating for bezel width.

180-Degree Image Rotation: When multiple monitors are set in a vertical direction, for optimizing narrower bezel of the top side, upper monitors can be inverted. This function can correct the screen rotation image without using an OS function, which supports, for example, easier Tile Matrix setting.

CUSTOMIZE SETTING: Allows to store the current settings and recover stored settings.

Low Blue Light: Low Blue Light function substantially reduces blue light and helps to alleviate eye-strain (see [page 24](#)).

Flicker Free: Special backlight system reduces flicker for less eyestrain.

NaViSet Administrator 2 Software: Offers an expanded and intuitive graphical interface, allowing you to more easily adjust OSD display settings from network PC.

Environmental Impact: Annual typical maximum operating carbon footprint of this monitor (world-wide average) is approximately 136.4 kg (calculated by: rated wattage x 8 hours per day x 5 days a week x 45 weeks per year x Power-to-Carbon conversion factor - conversion factor is based on OECD publication of global CO2 emissions 2008 Edition). This monitor has a manufacturing carbon footprint of approximately 63.2 kg.

Note: The manufacturing and operating carbon footprints are calculated by a unique algorithm developed exclusively by NEC for its monitors and are accurate at the time of printing. NEC reserves the right to publish updated carbon footprint values.

Troubleshooting

No picture

- Make sure the signal cable is fully connected to both the monitor and the computer.
- Make sure the computer's display card is fully seated in its slot.
- Do not use a DisplayPort converter adapter. This device is not supported.
- Make sure both the computer and monitor power switches are in the ON position.
- The monitor will automatically turn off by the "POWER SAVE TIMER" function when the "POWER SAVE TIMER" setting is "ON" and continues in power save mode for 2 hours. Please touch the power key.
- Make sure that a Major Supported Timings has been selected for the display card in the system being used. (Please consult the manual for the system or display card for supported resolution and changing the settings).
- Check the monitor and your display card with respect to compatibility and recommended settings.
- Check the signal cable connector for bent or pushed-in pins.
- Make sure the connected device outputs a signal to the monitor.
- If the front LED is dark blue, check the status of the OFF MODE SETTING mode (see [page 15](#)) or HUMAN SENSING (see [page 16](#)).

Power Key does not respond

- Unplug the monitor power cable from the AC outlet to turn off and reset the monitor.

Image Persistence

- Image persistence is when a residual or "ghost" image of a previous image remains visible on the screen. Unlike CRT monitors, LCD monitors' image persistence is not permanent, but constant images being displayed for a long period of time should be avoided. To alleviate image persistence, turn off the monitor for as long as the previous image was displayed. For example, if an image was on the monitor for one hour and a residual image remains, the monitor should be turned off for one hour to erase the image.

NOTE: As with all personal display devices, NEC DISPLAY SOLUTIONS recommends using a moving screen saver at regular intervals whenever the screen is idle or turning off the monitor when not in use.

Message "OUT OF RANGE" is displayed (screen is either blank or shows rough images only)

- OSD warning "OUT OF RANGE" is displayed on a rough image (pixels are missing): Either the signal clock or resolution is too high. Change the settings to a supported mode.
- OSD warning "OUT OF RANGE" is displayed on a blank screen: The signal frequency is out of range. Change the settings to a supported mode.

Image is unstable, unfocused or swimming is apparent

- Signal cable should be completely attached to the computer.
- Use the OSD Image Adjust controls to focus and adjust the display by increasing or decreasing the fine adjustment. When the display mode is changed, the OSD Image Adjust settings may need to be readjusted.
- Check the monitor and your display card with respect to compatibility and recommended signal timings.
- If your text is garbled, change the video mode to non-interlace and use 60Hz refresh rate.

LED on monitor is not lit (*no blue or amber color can be seen*)

- Power Switch should be in the ON position and power cord should be connected.
- Increase LED BRIGHTNESS adjustment.

Picture is not bright

- Make sure ECO MODE and AUTO BRIGHTNESS are turned off.
- If the brightness fluctuates, make sure AUTO BRIGHTNESS is turned off.
- Signal cable should be completely attached.
- LCD brightness degradation occurs due to long-term usage or extreme cold conditions.
- When using an HDMI input, please change "VIDEO LEVEL".
- If the brightness fluctuates, make sure DV MODE is set to STANDARD.

Display image is not sized properly

- Use the OSD Image Adjust controls to increase or decrease the Coarse adjustment.
- Make sure that a Major Supported Timings has been selected for the display card in the system being used. (Please consult the manual for the system or display card for supported resolution and changing the settings.)
- When using an HDMI input, please change "OVER SCAN".
- Please check "TILE MATRIX" and "180° ROTATE" settings.

No Video

- If no video is present on the screen, turn the Power key off and on again.
- Make sure the computer is not in a power-saving mode (touch the keyboard or mouse).
- When using DisplayPort, some display cards do not output video signal under low resolution modes when the monitor is turned OFF/ON or disconnected/connected from the AC power cord.
- When using an HDMI input, please change “OVER SCAN”.
- When using DisplayPort input please change DisplayPort settings (see [“Recovering from no image” on page 13](#)).
- Make sure VIDEO DETECT is set to NONE.

No Sound

- Make sure the speaker cable is properly connected.
- Check to see if mute is activated.
- Check the volume level in the OSD menu.
- If the input signal is DisplayPort or HDMI, make sure the SOUND INPUT in the OSD menu is set to DisplayPort or HDMI.

Brightness variations over time

- Change AUTO BRIGHTNESS to OFF and then adjust the brightness.
- Change DV MODE to STANDARD and then adjust the brightness.

NOTE: When AUTO BRIGHTNESS is set to ON, the monitor automatically adjusts brightness based on the environment. When the brightness of surrounding environment changes, the monitor will also change. When DV MODE is set to DYNAMIC, the monitor automatically adjusts the brightness.

USB Hub does not operate

- Make sure the USB cord is properly connected. Refer to your USB device User's Manual.
- Check that the USB upstream port on the monitor is connected to the USB downstream port on the computer. And make sure the computer is ON.

Human sensor does not work

- Make sure there is no object in front of the Human sensor.
- Make sure there is no equipment that radiates infrared rays in front of the monitor.

ControlSync does not work

- Make sure the ControlSync cable is connected correctly.
- Make sure the ControlSync cable is not in “loop” connection.
- Master monitor should be connected with ControlSync OUT connector only.
- Please use the provided ControlSync cable.
- You can use up to 8 sub monitors via ControlSync cables.

Displayed OSD menu is rotated

- Make sure of the OSD ROTATION setting.

USB Type-C device does not work

- Refer to the NEC Display Solutions website for the information of tested USB Type-C devices and cables.

“Warning: Remove USB-C cable” OSD was shown.

- The monitor detected abnormal voltage or current on USB-C port. Please remove USB-C cable immediately.

No picture

- Make sure USB FUNCTIONALITY is set to ON or AUTO.
- Check if the connected USB-C device complies with DisplayPort Alt Mode on USB Type-C.
- Check if the USB Type-C cable complies with USB 3.1 Gen.1 or Gen.2.

Charging is not started or unstable.

- Make sure USB FUNCTIONALITY is set to ON or AUTO.
- Check if the connected USB-C device complies with USB Power Delivery.
- Check if the USB Type-C cable complies with USB Power Delivery.
- If you still have trouble, unplug the monitor's power cord from the AC outlet and then remove the USB-C cable. Reconnect the power cord and then the USB-C cable.

No picture in multiple monitor connection

- Check to make sure that the resolution has been lower than the recommended resolution setting.
- Check to make sure that the display card supports MST (multi-stream transport).
- The number of monitors daisy-chained through SST (single-stream transport) depends on HDCP contents limitation.
- Monitors should be connected by the included DisplayPort cable.
- Check to make sure that DP OUT MULTISTREAM is “AUTO” and BIT RATE setting is “HBR2” when using MST (multi-stream transport) (see [page 13](#)).

Human sensing function

The Human sensing function reduces power consumption by detecting the movement of a person.

The HUMAN SENSING has following two settings:

MODE	HUMAN SENSING SETTING	No person in front of the monitor
LIGHT	1	BRIGHTNESS 0%
DEEP	2	Power saving mode

Image of human sensing operation

- A. When the sensor detects no person in front of the monitor, the monitor stays on for the period of time which is set at HUMAN SENSING > START TIME (see page 16).
- B. The monitor displays a notification on the screen after the period of time with no human detected has passed. You can set the notification screen at SENSOR INFORMATION (see page 21).

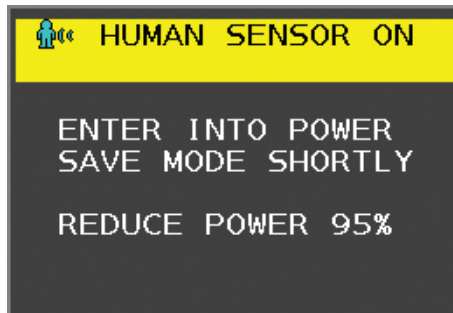

- C. After displaying the notification, if LIGHT is set at HUMAN SENSING, the monitor screen gets gradually darker until it gets to 0% brightness. If DEEP is set at HUMAN SENSING, the monitor enters into power saving mode.
- D. When the sensor detects a person coming back, the monitor is automatically returned from power saving mode to normal mode.

NOTE: When LIGHT is set at HUMAN SENSING, the monitor screen gets gradually brighter as it returns to the original brightness.

- E. The monitor returns to normal mode.

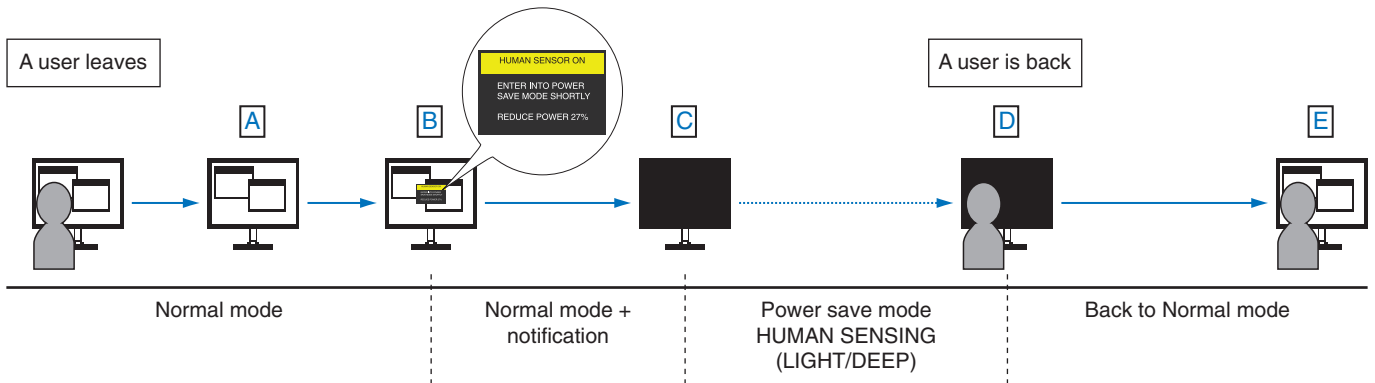

Multi Display setting

[Example of V MONITOR 3, H MONITOR 3 (See [page 22](#))]

1. Touch the MENU/EXIT key to display the OSD menu.
2. Touch the LEFT/RIGHT key to select MULTI DISPLAY.
3. Touch the DOWN/UP key to select H MONITOR. Move the LEFT/RIGHT key left or right to set H MONITOR 3.



4. Touch the DOWN/UP key to select V MONITOR. Touch the LEFT/RIGHT key to set V MONITOR 3.
5. Touch the DOWN/UP key to select MONITOR NO. then set the monitor number individually.

The monitor located at bottom left must be 1 (master monitor).

When you set the monitor number to a monitor, please install the monitor at the same spot where assumed installation figure is shown as black.

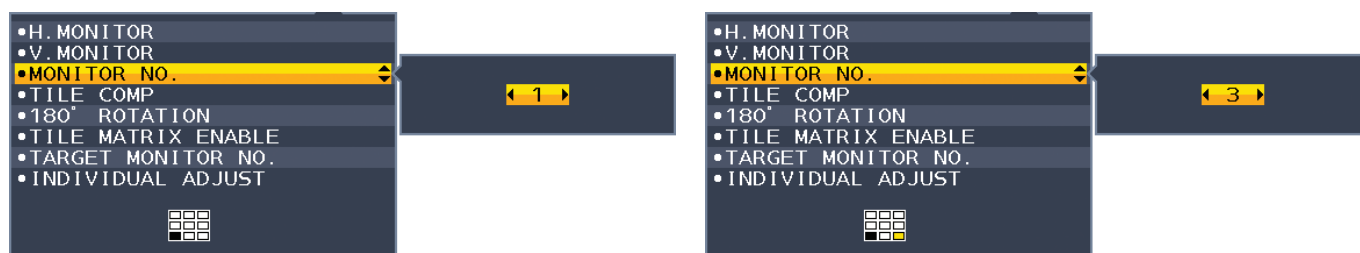
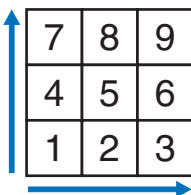

6. Touch the DOWN/UP key down to select TILE MATRIX ENABLE then set it to ON.
Set all connected monitors individually by following the above procedure from 1 to 6.

Using ControlSync function with multi screen configuration

To control a sub monitor from the master monitor, the control keys on the master monitor is used.

Please install the master monitor at an accessible place.

Mounting multi screen configuration

When monitors are used in a multi-screen configuration for a longer time, slight expansion of the displays may happen due to temperature changes. Due to this, it is recommended that over one millimeter gap is kept between adjacent display edges.

[Cable connection example]

H MONITOR 3

V MONITOR 3

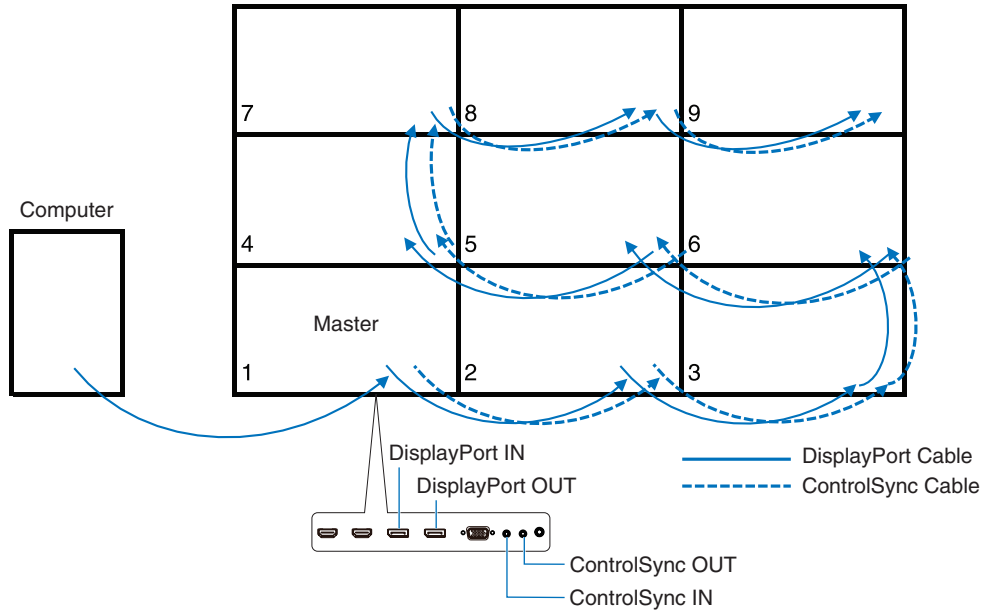

If monitors are connected with ControlSync cables, please make sure the monitor, which is connected to the computer, is the master monitor.

If you turn off one of the monitors in a multi-screen configuration with DisplayPort daisy-chain, the picture on monitors connected to that monitor will turn off.

To display the monitors, please turn on the monitor, which you turn off.

When you set one image to be displayed with TILE MATRIX ENABLE, please set the monitor number by referring MONITOR NO. (see [page 21](#)). You can assign numbers to the monitors in any order. The monitor numbers do not need to follow the order in which the cables are connected.

Using the Auto Brightness function

The brightness of the LCD screen can be set to increase or decrease depending on the amount of ambient lighting within the room. If the room is bright, the monitor becomes correspondingly bright. If the room is dim, then the monitor will dim accordingly. The purpose of this function is to make the viewing experience more comfortable to the eye in a variety of lighting conditions.

SETUP

Use the following procedures to select the Brightness Range that the monitor will use when the Auto Brightness function is activated.

1. Set the BRIGHTNESS level. This is the brightness level that the monitor will rise to when the ambient lighting level is highest. Select this setting when the room is at its brightest.

Select ON in the AUTO BRIGHTNESS menu (**Figure 1**). Then use the front Keys to move the cursor up to the BRIGHTNESS setting. Choose the desired brightness level (**Figure 2**).



Figure 1



Figure 2

2. Set the DARK level. This is the level of brightness that the monitor will lower to when the ambient lighting level is low. Make sure the room is at its darkest when setting this level.

Then use the front Keys to move the cursor up to the BRIGHTNESS setting. Choose the desired brightness level (**Figure 3**).

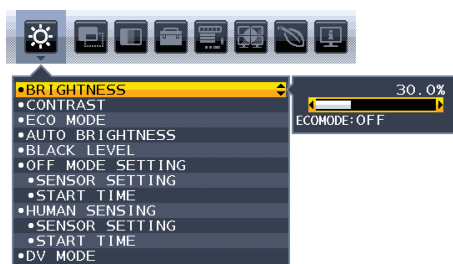

Figure 3

When the "Auto Brightness" function is enabled the Brightness level of the screen changes automatically according to the lighting conditions of the room (**Figure 4**).

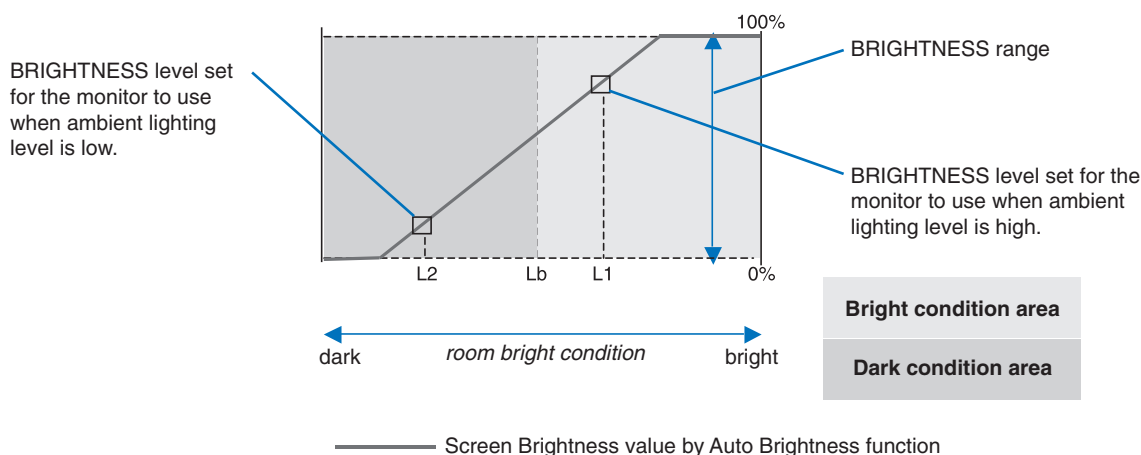

Figure 4

Lb: Border between bright and dim lighting conditions; set at the factory
 L1: BRIGHTNESS level set for the monitor to use when ambient lighting level is high ($L1 > Lb$)
 L2: BRIGHTNESS level set for the monitor to use when ambient lighting level is low ($L2 < Lb$)

L1 and L2 are the brightness levels set by the user to compensate for changes in ambient lighting.

Using the MULTI PICTURE function

This monitor can display split screens from two sources by using any one of the input combinations shown on [page 18](#).



NOTE: Please see MULTI PICTURE ([page 18](#)) and PICTURE PATTERN ([page 19](#)).
BRIGHTNESS and SOUND INPUT settings are set to be the same for both screens.

SETUP

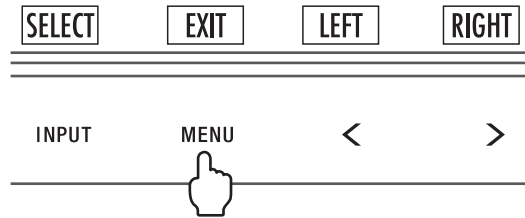
1. Touch MENU to show the OSD menu.



2. Select MULTI PICTURE.

In a Picture by Picture case, select Left  as an adjustable screen.
In a Picture in Picture case, select Main  as an adjustable screen.

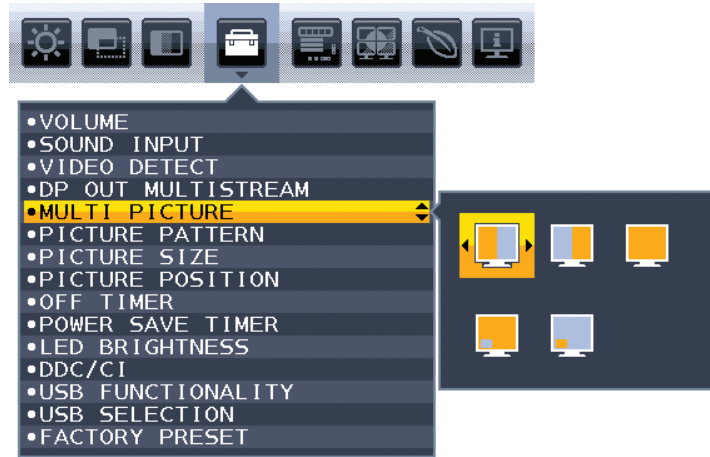



Exit the OSD menu in order to change the signal input.

3. Touch INPUT, then select the input signal used by the selected screen.



4. Return to 1 to select the input for the other screen.

In a Picture by Picture case, select Right  then setup input signal.
In a Picture in Picture case, select Sub  then setup input signal.

Using the Zoom function

Allows you to use the entire screen area, significantly expanding the size.
Allows the picture displayed in the center to expand.

NOTE: When LEFT or RIGHT is set at MULTI PICTURE, the other picture is expanded or reduced automatically.

SETUP

1. Select FULL or ASPECT in EXPANSION to activate the Zoom function (see [page 17](#)).

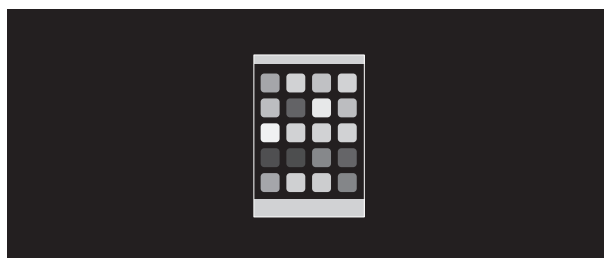

EXPANSION OFF

2. Set a resolution via H.RESOLUTION or V.RESOLUTION (see [page 16](#)).

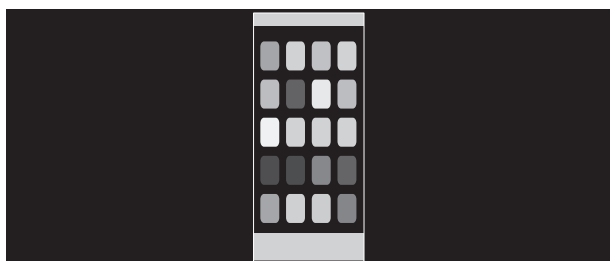

Vertical expanding



Horizontal expanding

3. The image position can be moved from the center to left or right by selecting LEFT/RIGHT and upward or downward by selecting UP/DOWN (see [page 16](#)).



Move left or right



Move upward or downward

NOTE: When showing 2 screens, the input resolution of the main (adjustable) image is prioritized.

- A. The right image is set to be the main one.
In this case, the priority image is set to be on the right side with black area shown. The input resolution for the image on the left side is decreased.

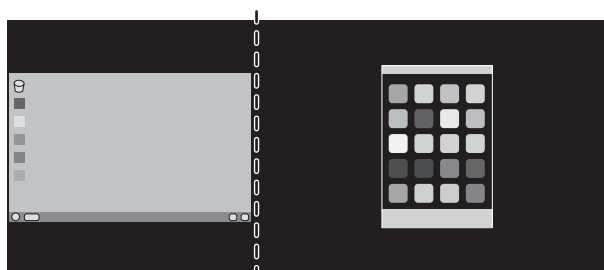

- B. The left image is set to be the main one.
In this case, the priority image is set to be on the left side.
The size of the image on the right side with black area is reduced.

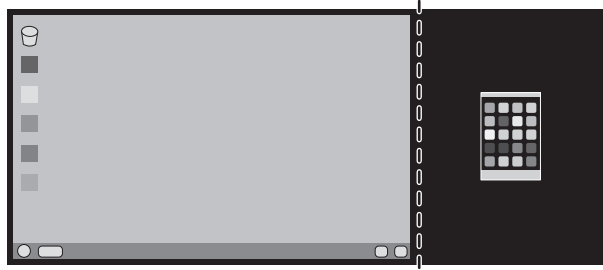

To enlarge the split images: use the following procedures to reduce the black area and enlarge the split images.

1. In case A, a priority image is set to be on the right side. The size of the black area can be reduced by adjusting the resolution (see [page 16](#)).

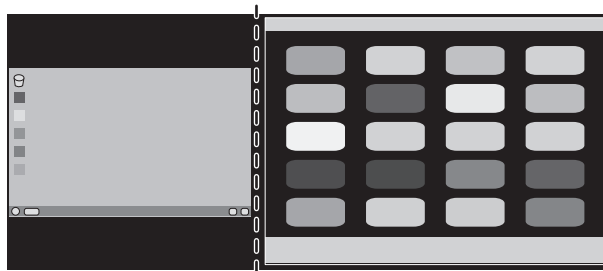

2. Move the priority image to the left side.

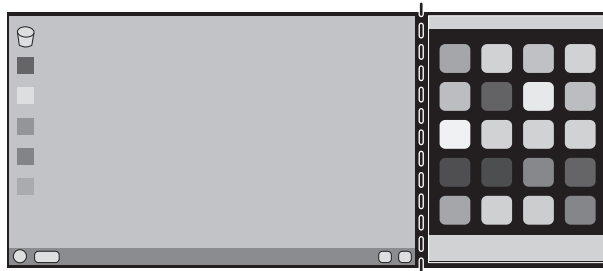

Manufacturer's Recycling and Energy Information

NEC DISPLAY SOLUTIONS is strongly committed to environmental protection and sees recycling as one of the company's top priorities in trying to minimize the burden placed on the environment. We are engaged in developing environmentally-friendly products, and always strive to help define and comply with the latest independent standards from agencies such as ISO (International Organisation for Standardization) and TCO (Swedish Trades Union).

Disposing of your old NEC product

The aim of recycling is to gain an environmental benefit by means of re-use, upgrading, reconditioning or reclamation of material. Dedicated recycling sites ensure that environmentally harmful components are properly handled and securely disposed. To ensure the best recycling of our products, **NEC DISPLAY SOLUTIONS offers a variety of recycling procedures** and gives advice on how to handle the product in an environmentally sensitive way, once it has reached the end of its life.

All required information concerning the disposal of the product and country-specific information on recycling facilities can be found on our following websites:

<http://www.nec-display-solutions.com/greencompany/> (in Europe),

<https://www.nec-display.com> (in Japan) or

<http://www.necdisplay.com> (in USA).

Energy Saving

This monitor features an advanced energy saving capability. When a Display Power Management signal is sent to the monitor, the Energy Saving mode is activated. The monitor enters a single Energy Saving mode.

Mode	Power consumption	LED color
Maximum Operation	150 W	Blue
Normal Operation	37 W Default setting, USB/Audio sleeping	Blue
Energy Saving Mode	0.35 W*	Amber
Off Mode	0.29 W	Unlit

*: Factory settings.

For additional information visit:

<http://www.necdisplay.com/> (in USA)

<http://www.nec-display-solutions.com/> (in Europe)

<https://www.nec-display.com/global/index.html> (Global)

For Energy Saving information: [Default setting: USB FUNCTIONALITY → Off]

For ErP requirement:

Setting: [Default setting: USB FUNCTIONALITY → Off]

Power consumption: 0.5 W or less.

Time for power management function: Approx. 1 min.

For ErP (Network standby) requirement:

Setting: [Default setting: USB FUNCTIONALITY → Off]

Power consumption: 0.5 W or less (with 1 port activating) / 3.0 W or less (with all ports activating).

Time for power management function: Approx. 1 min.

WEEE Mark (European Directive 2012/19/EU and amendments)



Disposing of your used product: In the European Union

EU-wide legislation as implemented in each Member State requires that used electrical and electronic products carrying the mark (left) must be disposed of separately from normal household waste. This includes monitors and electrical accessories, such as signal cables or power cords. When you dispose of such products, please follow the guidance of your local authority or ask the shop where you purchased the product, or if applicable, follow applicable legislation or agreement you may have. The mark on electrical and electronic products may only apply to the current European Union Member States.

Outside the European Union

If you wish to dispose of used electrical and electronic products outside the European Union, please contact your local authority and ask for the correct method of disposal.