



Auranet

User Guide

For TP-Link Auranet Access Points

REV1.0.0
1910011884

COPYRIGHT & TRADEMARKS

Specifications are subject to change without notice.  ^{tp-link} is a registered trademark of TP-Link TECHNOLOGIES CO., LTD. Other brands and product names are trademarks or registered trademarks of their respective holders.

No part of the specifications may be reproduced in any form or by any means or used to make any derivative such as translation, transformation, or adaptation without permission from TP-Link TECHNOLOGIES CO., LTD. Copyright © 2016 TP-Link TECHNOLOGIES CO., LTD. All rights reserved.

FCC STATEMENT



This equipment has been tested and found to comply with the limits for a Class B digital device, pursuant to part 15 of the FCC Rules. These limits are designed to provide reasonable protection against harmful interference in a residential installation. This equipment generates, uses and can radiate radio frequency energy and, if not installed and used in accordance with the instructions, may cause harmful interference to radio communications. However, there is no guarantee that interference will not occur in a particular installation. If this equipment does cause harmful interference to radio or television reception, which can be determined by turning the equipment off and on, the user is encouraged to try to correct the interference by one or more of the following measures:

- Reorient or relocate the receiving antenna.
- Increase the separation between the equipment and receiver.
- Connect the equipment into an outlet on a circuit different from that to which the receiver is connected.
- Consult the dealer or an experienced radio/ TV technician for help.

This device complies with part 15 of the FCC Rules. Operation is subject to the following two conditions:

- 1) This device may not cause harmful interference.
- 2) This device must accept any interference received, including interference that may cause undesired operation.

Any changes or modifications not expressly approved by the party responsible for compliance could void the user's authority to operate the equipment.

Note: The manufacturer is not responsible for any radio or TV interference caused by unauthorized modifications to this equipment. Such modifications could void the user's authority to operate the equipment.

FCC RF Radiation Exposure Statement:

This equipment complies with FCC RF radiation exposure limits set forth for an uncontrolled environment. This device and its antenna must not be co-located or operating in conjunction with any other antenna or transmitter.

"To comply with FCC RF exposure compliance requirements, this grant is applicable to only Mobile Configurations. The antennas used for this transmitter must be installed to provide a separation distance of at least 20 cm from all persons and must not be co-located or operating in conjunction with any other antenna or transmitter."

CE Mark Warning

CE 1588

This is a class B product. In a domestic environment, this product may cause radio interference, in which case the user may be required to take adequate measures.

RF Exposure Information

This device meets the EU requirements (1999/5/EC Article 3.1a) on the limitation of exposure of the general public to electromagnetic fields by way of health protection.

The device complies with RF specifications when the device used at 20 cm from your body.

Canadian Compliance Statement

This device complies with Industry Canada license-exempt RSSs. Operation is subject to the following two conditions:

- 1) This device may not cause interference, and
- 2) This device must accept any interference, including interference that may cause undesired operation of the device.

Le présent appareil est conforme aux CNR d'Industrie Canada applicables aux appareils radio exempts de licence. L'exploitation est autorisée aux deux conditions suivantes :

- 1) l'appareil ne doit pas produire de brouillage;
- 2) l'utilisateur de l'appareil doit accepter tout brouillage radioélectrique subi, même si le brouillage est susceptible d'en compromettre le fonctionnement.

This radio transmitter (IC: 8853A-EAP110-Outdoor/ Model: EAP110-Outdoor) has been approved by Industry Canada to operate with the antenna types listed below with the maximum permissible gain indicated. Antenna types not included in this list below, having a gain greater than the maximum gain indicated for that type, are strictly prohibited for use with this device.

Le présent émetteur radio (IC: 8853A- EAP110-Outdoor / Model: EAP110-Outdoor) a été approuvé par Industrie Canada pour fonctionner avec les types d'antenne énumérés ci-dessous et ayant un gain admissible maximal. Les types d'antenne non inclus dans cette liste ci-dessous et dont le gain est supérieur au gain maximal indiqué, sont strictement interdits pour l'exploitation de l'émetteur.

Antenna	Two 2.4GHz 5dBi external omnidirectional antennas
---------	---

Radiation Exposure Statement

This equipment complies with IC radiation exposure limits set forth for an uncontrolled environment. This equipment should be installed and operated with minimum distance 20cm between the radiator & your body.

Déclaration d'exposition aux radiations

Cet équipement est conforme aux limites d'exposition aux rayonnements IC établies pour un environnement non contrôlé. Cet équipement doit être installé et utilisé avec un minimum de 20 cm de distance entre la source de rayonnement et votre corps.

Industry Canada Statement

CAN ICES-3 (B)/NMB-3(B)



Продукт сертифіковано згідно с правилами системи УкрСЕПРО на відповідність вимогам нормативних документів та вимогам, що передбачені чинними законодавчими актами України.



Safety Information

- When product has power button, the power button is one of the way to shut off the product; When there is no power button, the only way to completely shut off power is to disconnect the product or the power adapter from the power source.
- Don't disassemble the product, or make repairs yourself. You run the risk of electric shock and voiding the limited warranty. If you need service, please contact us.
- Avoid water and wet locations.
- Adapter shall be installed near the equipment and shall be easily accessible.
- The plug considered as disconnect device of adapter.



Use only power supplies which are provided by manufacturer and in the original packing of this product. If you have any questions, please don't hesitate to contact us.

NCC Notice & BSMI Notice

注意！

依據 低功率電波輻射性電機管理辦法



第十二條 經型式認證合格之低功率射頻電機，非經許可，公司、商號或使用者均不得擅自變更頻率、加大功率或變更原設計之特性或功能。

第十四條 低功率射頻電機之使用不得影響飛航安全及干擾合法通行；經發現有干擾現象時，應立即停用，並改善至無干擾時方得繼續使用。前項合法通信，指依電信規定作業之無線電信。低功率射頻電機需忍受合法通信或工業、科學以及醫療用電波輻射性電機設備之干擾。

安全諮詢及注意事項

- 請使用原裝電源供應器或只能按照本產品注明的電源類型使用本產品。
- 清潔本產品之前請先拔掉電源線。請勿使用液體、噴霧清潔劑或濕布進行清潔。
- 注意防潮，請勿將水或其他液體潑灑到本產品上。
- 插槽與開口供通風使用，以確保本產品的操作可靠並防止過熱，請勿堵塞或覆蓋開口。
- 請勿將本產品置放於靠近熱源的地方。除非有正常的通風，否則不可放在密閉位置中。
- 請不要私自打開機殼，不要嘗試自行維修本產品，請由授權的專業人士進行此項工作。

Explanation of the symbols on the product label

Symbol	Explanation
	DC voltage
	<p>RECYCLING</p> <p>This product bears the selective sorting symbol for Waste electrical and electronic equipment (WEEE). This means that this product must be handled pursuant to European directive 2012/19/EU in order to be recycled or dismantled to minimize its impact on the environment.</p> <p>User has the choice to give his product to a competent recycling organization or to the retailer when he buys a new electrical or electronic equipment.</p>

CONTENTS

About this User Guide	1
Chapter 1 Introduction	2
Chapter 2 Network Topology.....	3
Chapter 3 Management Mode	5
3.1 Standalone Mode.....	5
3.2 Managed Mode	5
3.3 Switch to Standalone Mode	5
Chapter 4 Network.....	6
Chapter 5 Wireless.....	7
5.1 Wireless Settings	8
5.1.1 Wireless Basic Settings	9
5.1.2 SSIDs.....	10
5.1.3 Wireless Advanced Settings.....	14
5.1.4 Load Balance	15
5.2 Portal	15
5.2.1 Portal Configuration.....	16
5.2.2 Free Authentication Policy.....	21
5.3 MAC Filtering	23
5.4 Scheduler.....	25
5.5 QoS	29
5.5.1 AP EDCA Parameters	29
5.5.2 Station EDCA Parameters.....	31
5.6 Rogue AP Detection.....	32
5.6.1 Settings	33
5.6.2 Detected Rogue AP List.....	33
5.6.3 Trusted AP List.....	34
5.6.4 Download/Backup Trusted AP List	35
Chapter 6 Monitoring.....	36
6.1 AP	36
6.1.1 AP List.....	36
6.2 SSID	41

6.2.1	SSID List.....	41
6.3	Client.....	42
6.3.1	User List	42
6.3.2	Portal Authenticated Guest.....	43
Chapter 7	Management.....	45
7.1	System Log	45
7.1.1	Log List.....	45
7.1.2	Log Settings.....	46
7.2	Web Server.....	47
7.3	Management Access.....	48
7.4	LED ON/OFF.....	49
7.5	SSH	50
7.6	Management VLAN	50
7.7	SNMP	51
Chapter 8	System.....	54
8.1	User Account.....	54
8.2	Time Settings.....	54
8.2.1	Time Settings	55
8.2.2	Daylight Saving	56
8.3	Reboot/Reset	57
8.4	Backup & Restore.....	58
8.5	Firmware Upgrade	58

About this User Guide

When using this guide, please notice that features of the EAP may vary slightly depending on the model and software version you have, and on your location, language, and Internet service provider. All screenshots, images, parameters and descriptions documented in this guide are used for demonstration only.

The information in this document is subject to change without notice. Every effort has been made in the preparation of this document to ensure accuracy of the contents, but all statements, information, and recommendations in this document do not constitute the warranty of any kind, express or implied. Users must take full responsibility for their application of any product.

Chapter 4 to Chapter 8 are only suitable for the EAP in Standalone mode. Refer to the EAP Controller User Guide from our website at www.tp-link.com when the EAP is managed by the EAP Controller software.

Convention

Unless otherwise noted, the EAP or the device mentioned in this guide stands for EAP110-Outdoor.

More Info

The latest software, management app and utility can be found at Download Center at www.tp-link.com/support.

The Quick Installation Guide can be found where you find this guide or inside the package of the EAP.

Specifications can be found on the product page at <http://www.tp-link.com>.

A Technical Support Forum is provided for you to discuss our products at <http://forum.tp-link.com>.

Our Technical Support contact information can be found at the Contact Technical Support page at www.tp-link.com/support.

Chapter 1 Introduction

Auranet series products provide wireless coverage solutions for small-medium business. They can either work independently as standalone APs or be centrally managed by the EAP Controller software, providing a flexible, richly-functional but easily-configured enterprise-grade wireless network for small and medium business.

EAP110-Outdoor:



Figure 1-1 View of the EAP

Chapter 2 Network Topology

A typical network topology for the EAP is shown below.

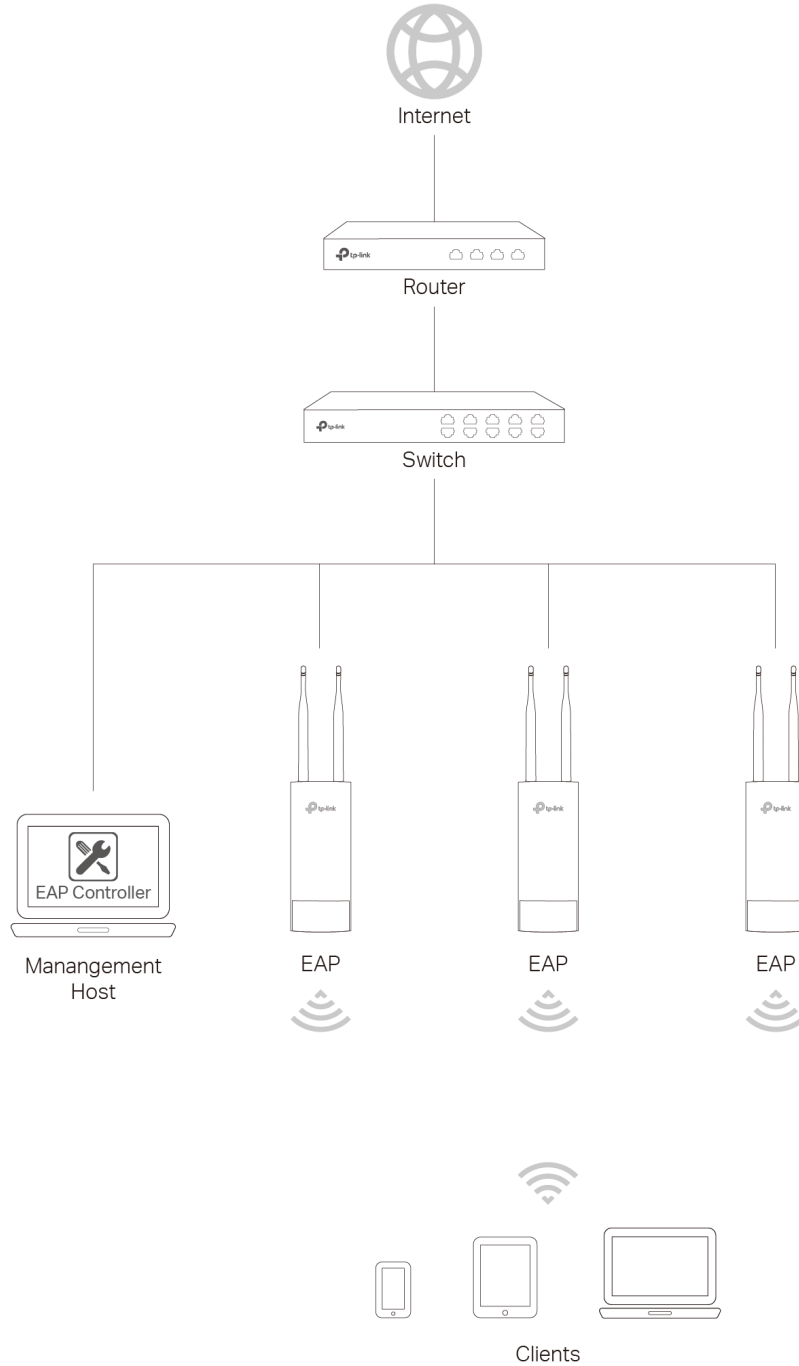

Figure 2-1 Typical Topology

To deploy an EAP in your local network, a DHCP server is required to assign IP addresses to the EAP and clients. Typically, a router acts as the DHCP server. A computer running the EAP Controller software can locate in the same or different subnet with the EAPs.

The EAP can be managed by the EAP Controller software, which is a management software specially designed for the TP-Link EAP devices on a local wireless network, allowing you to centrally configure and monitor mass EAP devices using a web browser on your PC. For more information about the EAP Controller, please find the **EAP Controller User Guide** from our official website:

<http://www.tp-link.com/en/support/download/>

Chapter 3 Management Mode

Auranet series products can either work under the control of the EAP Controller software or work independently as a standalone access point.

When user establishes a large-scale wireless network, the management of every single AP in the network is complex and complicated. With the EAP Controller software, you can centrally manage the mass APs simply in a web browser.

The Standalone mode applies to a relatively small-sized wireless network. EAPs in the Standalone mode cannot be managed centrally by the EAP Controller software.

3.1 Standalone Mode

By default, the EAP works independently as a standalone access point. By entering the IP address of the standalone EAP, you can log in to its web interface and perform configurations.

The factory default IP address configuration of the EAP is DHCP (Dynamic Host Configuration Protocol). Before you access the web interface of the EAP, please make sure the DHCP server works properly. Typically, a router acts as the DHCP server.

Follow the steps below to log in to the web interface of a standalone EAP.

1. Launch a web browser, enter the DHCP address in the address field and press the **Enter** key.
2. Enter **admin** (all lowercase) for both username and password.

3.2 Managed Mode

The EAP will become a managed AP once it is adopted via the EAP Controller software. Users can manage the AP via a web browser. Refer to the **EAP Controller User Guide** from our website at www.tp-link.com to know more about EAP Controller software.

3.3 Switch to Standalone Mode

The web interface of a specific EAP is not available once this EAP is adopted by the EAP Controller. You can *Forget* the EAP via the EAP Controller to turn it back as a standalone AP. Refer to the **EAP Controller User Guide** from our website at www.tp-link.com to learn more.

Chapter 4 Network

On *Network* page you can configure the IP address of the standalone EAP.

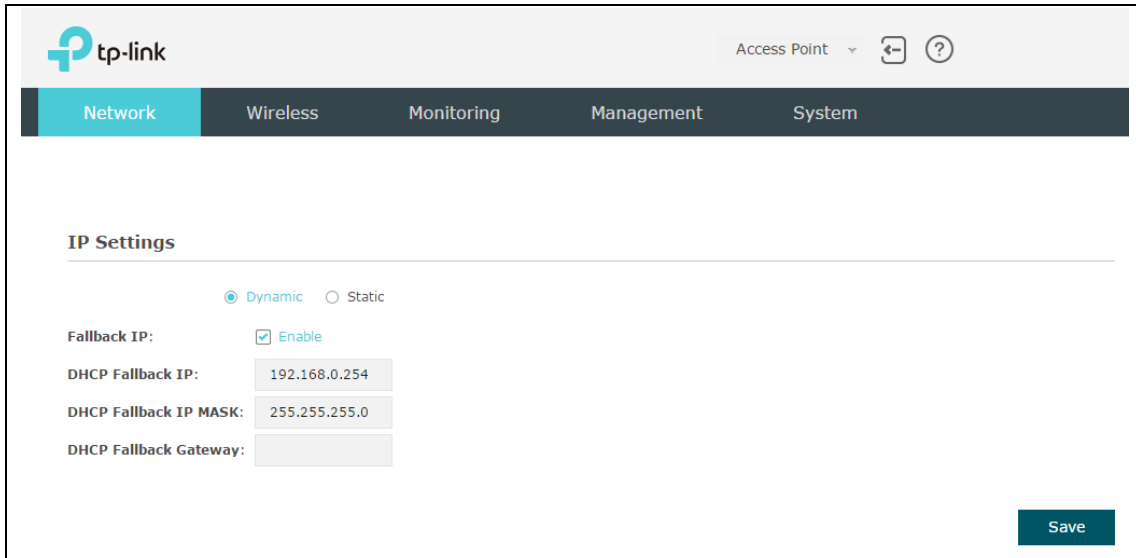

Figure 4-1 Network Page

Dynamic/Static: By default, the EAP device obtains an IP address from a DHCP server (typically a router). Select **Static** to configure IP address manually.

Fallback IP: If the EAP fails to get a dynamic IP address from a DHCP server within ten seconds, the fallback IP will work as the IP address of the device. After that, however, the device will keep trying to obtain an IP address from the DHCP server until it succeeds.

DHCP Fallback IP/IP MASK: Enter the fallback IP/IP mask.

DHCP Fallback Gateway: Enter the fallback gateway.

Chapter 5 Wireless

Wireless page, consisting of Wireless Settings, Portal, MAC Filtering, Scheduler, QoS and Rogue AP Detection, is shown below.

The screenshot shows the TP-Link web interface for configuring wireless settings. The top navigation bar includes 'Network', 'Wireless', 'Monitoring', 'Management', and 'System'. Under 'Wireless', there are sub-tabs for 'Wireless Settings', 'Portal', 'MAC Filtering', 'Scheduler', 'QoS', and 'Rogue AP Detection'. The 'Wireless Settings' tab is active.

Wireless Basic Settings

2.4GHz Wireless Radio: Enable

Wireless Mode: 802.11b/g/n mixed

Channel Width: 20/40MHz

Channel: Auto

Tx Power(EIRP): 20 dBm(9-20)

Note:
The EIRP transmit power includes the antenna gain.

Save

SSIDs

[+ Add](#)

ID	SSID Name	Wireless VLAN ID	SSID Broadcast	Security Mode	Portal	SSID Isolation	Modify
1	TP-LINK_2.4GHz_C0A877	0	Enable	None	Disable	Disable	✎ 🗑

Wireless Advanced Settings

Beacon Interval: 100 ms (40-100)

DTIM Period: 1 (1-255)

RTS Threshold: 2347 (1-2347)

Fragmentation Threshold: 2346 (256-2346, works only in 11b/g mode)

Save

Load Balance

Load Balance: ON OFF

Maximum Associated Clients: 0 (1-99)

Save

Figure 5-1 Wireless Page

5.1 Wireless Settings

Following is the page of *Wireless Settings*.

Access Point ▼
↶ ?

Network
Wireless
Monitoring
Management
System

Wireless Settings
Portal
MAC Filtering
Scheduler
QoS
Rogue AP Detection

Wireless Basic Settings

2.4GHz Wireless Radio: Enable

Wireless Mode: 802.11b/g/n mixed ▼

Channel Width: 20/40MHz ▼

Channel: Auto ▼

Tx Power(EIRP): 20 dBm(9-20)

Note:
The EIRP transmit power includes the antenna gain.

Save

SSIDs

+ Add

ID	SSID Name	Wireless VLAN ID	SSID Broadcast	Security Mode	Portal	SSID Isolation	Modify
1	TP-LINK_2.4GHz_C0A877	0	Enable	None	Disable	Disable	✎ 🗑️

Wireless Advanced Settings

Beacon Interval: 100 ms (40-100)

DTIM Period: 1 (1-255)

RTS Threshold: 2347 (1-2347)

Fragmentation Threshold: 2346 (256-2346, works only in 11b/g mode)

Save

Load Balance

Load Balance: ON OFF

Maximum Associated Clients: 0 (1-99)

Save

Figure 5-2 Wireless Settings Page

5.1.1 Wireless Basic Settings

Wireless Basic Settings

2.4GHz Wireless Radio: Enable

Wireless Mode: 802.11b/g/n mixed ▼

Channel Width: 20/40MHz ▼

Channel: Auto ▼

Tx Power(EIRP): 20 dBm(9-20)

Note:
The EIRP transmit power includes the antenna gain.

Save

Figure 5-3 Wireless Basic Settings

2.4GHz Wireless Radio: Check the box to enable 2.4GHz Wireless Radio.

Wireless Radio:

Wireless Mode: Select the protocol standard for the wireless network.

We recommend that select 802.11b/g/n, in which way clients supporting any one of these modes can access your wireless network.

Channel Width: Select the channel width of this device.

According to IEEE 802.11n standard, using a higher bandwidth can increase wireless throughput. However, users may choose lower bandwidth due to the following reasons:

1. To increase the available number of channels within the limited total bandwidth.
2. To avoid interference from overlapping channels occupied by other devices in the environment.
3. Lower bandwidth can concentrate higher transmit power, increasing stability of wireless links over long distances.

Channel: Select the channel used by this device to improve wireless performance. 1/2412MHz means the Channel is 1 and the frequency is 2412MHz. By default, channel is automatically selected.

Tx power: Enter the transmit power value. By default, the value is 20.

If the maximum transmit power is set to be larger than local regulation allows, the maximum Tx power regulated will be applied in actual situation.

NOTE In most cases, it is unnecessary to select maximum transmit power. Selecting larger transmit power than needed may cause interference to neighborhood. Also it consumes more power and will

reduce longevity of the device. Select a certain transmit power is enough to achieve the best performance.

5.1.2 SSIDs

SSIDs can work together with switches supporting 802.1Q VLAN. The EAP can build up to eight virtual wireless networks per radio for users to access. At the same time, it adds different VLAN tags to the clients which connect to the corresponding wireless network. It supports maximum 8 VLANs per radio. The clients in different VLAN cannot directly communicate with each other.

Clients connected to the device via cable do not belong to any VLAN. Thus wired client can communicate with all the wireless clients despite the VLAN settings.

Click  in the Modify column, the following content will be shown.

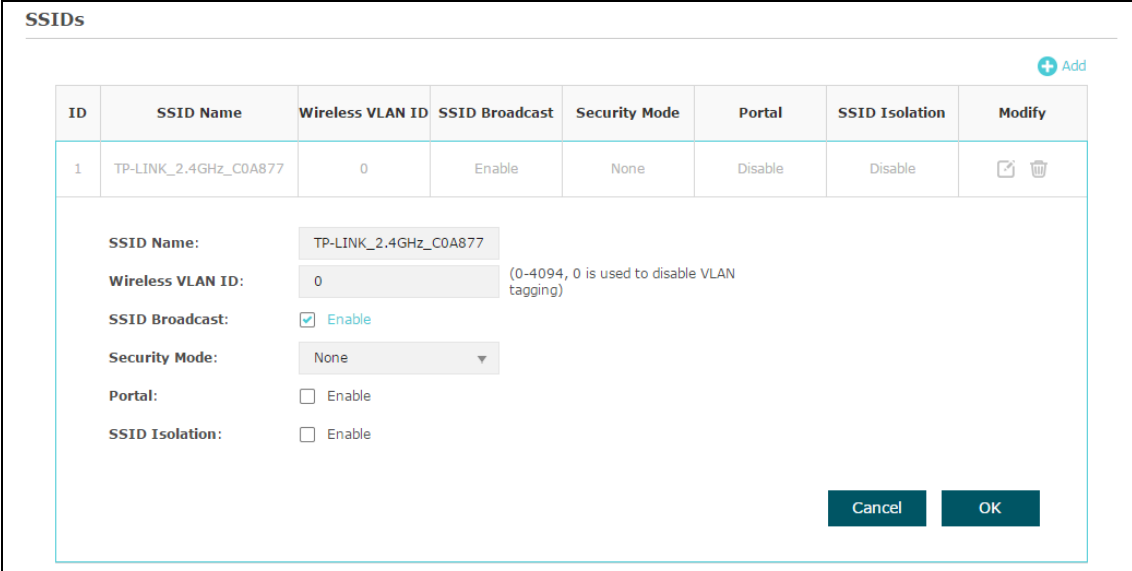

The screenshot displays the 'SSIDs' configuration page. At the top right, there is an '+ Add' button. Below it is a table with the following columns: ID, SSID Name, Wireless VLAN ID, SSID Broadcast, Security Mode, Portal, SSID Isolation, and Modify. The table contains one row with ID '1', SSID Name 'TP-LINK_2.4GHz_C0A877', Wireless VLAN ID '0', SSID Broadcast 'Enable', Security Mode 'None', Portal 'Disable', and SSID Isolation 'Disable'. The 'Modify' column for this row contains an edit icon and a trash icon. Below the table, a configuration form is shown for the selected SSID. The form includes the following fields and options:

- SSID Name:** TP-LINK_2.4GHz_C0A877
- Wireless VLAN ID:** 0 (0-4094, 0 is used to disable VLAN tagging)
- SSID Broadcast:** Enable
- Security Mode:** None (dropdown menu)
- Portal:** Enable
- SSID Isolation:** Enable

At the bottom right of the form, there are 'Cancel' and 'OK' buttons.

Figure 5-4 SSIDs



Click to add up to 8 wireless networks per radio.

SSID Name: Enter up to 32 characters as the SSID name.



Wireless VLAN ID: Set a VLAN ID for the wireless network.
Wireless networks with the same VLAN ID are grouped to a VLAN.

SSID Broadcast: Enable this function, AP will broadcast its SSID to hosts in the surrounding environment, as thus hosts can find the wireless network identified by this SSID. If SSID Broadcast is not enabled, hosts must enter the AP's SSID manually to connect to this AP.

Security Mode: Select the security mode of the wireless network. For the security of wireless network, you are suggested to encrypt your wireless network. This device provides three security modes: **WPA-Enterprise**, **WPA-PSK** (WPA Pre-Shared Key) and **WEP** (Wired Equivalent Privacy). WPA-PSK is recommended. Settings vary in different security modes as the details are in the following introduction. Select **None** and the hosts can access the wireless network without password.

Portal: Portal provides authentication service for the clients who want to access the wireless local area network. For more information, refer to [5.2 Portal](#). After Portal is enabled, the configurations in [5.2 Portal](#) will be applied.

SSID Isolation: After enabling SSID Isolation, the devices connected in the same SSID cannot communicate with each other.

Modify: Click  to open the page to edit the parameters of SSID.
Click  to delete the SSID.

Following is the detailed introduction of security mode: **WEP**, **WPA-Enterprise** and **WPA-PSK**.

- **WEP**

WEP (Wired Equivalent Privacy), based on the IEEE 802.11 standard, is less safe than WPA-Enterprise or WPA-PSK.

NOTE:

WEP is not supported in 802.11n mode. If WEP is applied in 802.11n mode, the clients may not be able to access the wireless network. If WEP is applied in 11b/g/n mode, the device may work at a low transmission rate.

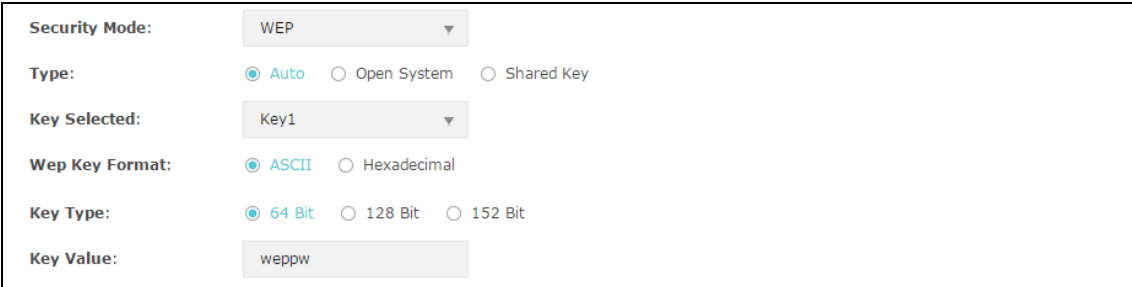

The screenshot shows a configuration interface for WEP security mode. It includes the following fields and options:

- Security Mode:** A dropdown menu set to "WEP".
- Type:** Radio buttons for "Auto" (selected), "Open System", and "Shared Key".
- Key Selected:** A dropdown menu set to "Key1".
- Wep Key Format:** Radio buttons for "ASCII" (selected) and "Hexadecimal".
- Key Type:** Radio buttons for "64 Bit" (selected), "128 Bit", and "152 Bit".
- Key Value:** A text input field containing "weppw".

Figure 5-5 Security Mode-WEP

Type: Select the authentication type for WEP.

- **Auto:** The default setting is Auto, which can select Open System or Shared Key automatically based on the wireless station's capability and request.

- **Open System:** After you select Open System, clients can pass the authentication and associate with the wireless network without password. However, correct password is necessary for data transmission.
- **Shared Key:** After you select Shared Key, clients has to input password to pass the authentication, or it cannot associate with the wireless network or transmit data.

Key Selected: You can configure four keys in advance and select one as the present valid key.

Wep Key Format: Select the wep key format ASCII or Hexadecimal.

- **ASCII:** ASCII format stands for any combination of keyboard characters in the specified length.
- **Hexadecimal:** Hexadecimal format stands for any combination of hexadecimal digits (0-9, a-f, A-F) in the specified length.

Key Type: Select the WEP key length for encryption.

- **64-bit:** You can enter 10 hexadecimal digits (any combination of 0-9, a-f, A-F without null key) or 5 ASCII characters.
- **128-bit:** You can enter 26 hexadecimal digits (any combination of 0-9, a-f, A-F without null key) or 13 ASCII characters.
- **152-bit:** You can enter 32 hexadecimal digits (any combination of 0-9, a-f, A-F without null key) or 16 ASCII characters.

Key Value: Enter the key value.

• WPA-Enterprise

Based on RADIUS server, WPA-Enterprise can generate different passwords for different users and it is much safer than WPA-PSK. However, it costs much to maintain and is more suitable for enterprise users. At present, WPA-Enterprise has two versions: WPA-PSK and WPA2-PSK.

Security Mode:	WPA-Enterprise ▼	
Version:	<input checked="" type="radio"/> Auto <input type="radio"/> WPA-PSK <input type="radio"/> WPA2-PSK	
Encryption:	<input checked="" type="radio"/> Auto <input type="radio"/> TKIP <input type="radio"/> AES	
Radius Server IP:	0.0.0.0	
Radius Port:	0	(1-65535,0 means default port 1812)
Radius Password:		
Group Key Update Period:	0	seconds(30-8640000,0 means no upgrade)

Figure 5-6 Security Mode_WPA-Enterprise

Version:	Select one of the following versions: <ul style="list-style-type: none"> • Auto: Select WPA-PSK or WPA2-PSK automatically based on the wireless station's capability and request. • WPA-PSK: Pre-shared key of WPA. • WPA2-PSK: Pre-shared key of WPA2.
Encryption:	Select the encryption type, including Auto , TKIP , and AES . The default setting is Auto, which can select TKIP (Temporal Key Integrity Protocol) or AES (Advanced Encryption Standard) automatically based on the wireless station's capability and request. AES is more secure than TKIP and TKIP is not supported in 802.11n mode. It is recommended to select AES as the encryption type.
RADIUS Server IP/Port:	Enter the IP address/port of the RADIUS server.
RADIUS Password:	Enter the shared secret of RADIUS server to access the RADIUS server.
Group Key Update period:	Specify the group key update period in seconds. The value can be either 0 or 30-8640000 seconds.

NOTE:

Encryption type TKIP is not supported in 802.11n mode. If TKIP is applied in 802.11n mode, the clients may not be able to access the wireless network of the EAP. If TKIP is applied in 11b/g/n mode, the device may work at a low transmission rate.

• **WPA-PSK**

Based on pre-shared key, security mode WPA-PSK is characterized by high security and simple configuration, which suits for common households and small business. WPA-PSK has two versions: WPA-PSK and WPA2-PSK.

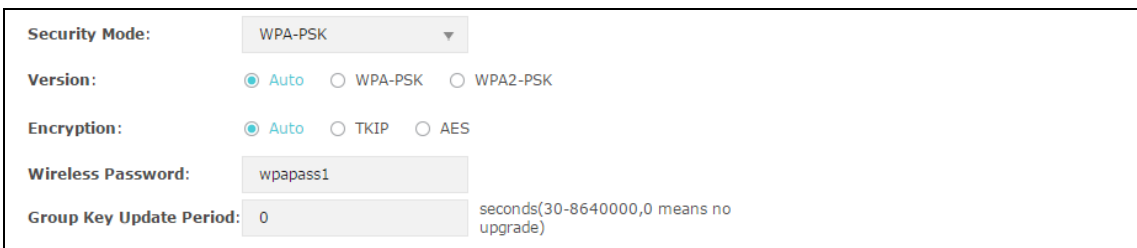

Figure 5-7 Security Mode_WPA-PSK

Version:	<ul style="list-style-type: none"> • Auto: Select WPA-PSK or WPA2-PSK automatically based on the wireless station's capability and request.
-----------------	---

- **WPA-PSK:** Pre-shared key of WPA.
- **WPA2-PSK:** Pre-shared key of WPA2.

Encryption: Select the encryption type, including **Auto**, **TKIP**, and **AES**. The default setting is Auto, which can select TKIP (Temporal Key Integrity Protocol) or AES (Advanced Encryption Standard) automatically based on the wireless station's capability and request. AES is more secure than TKIP and TKIP is not supported in 802.11n mode. It is recommended to select AES as the encryption type.

Wireless Password: Configure the WPA-PSK/WPA2-PSK password with ASCII or Hexadecimal characters. For ASCII, the length should be between 8 and 63 characters with combination of numbers, letters (case-sensitive) and common punctuations. For Hexadecimal, the length should be 64 characters (case-insensitive, 0-9, a-f, A-F).

Group Key Update Period: Specify the group key update period in seconds. The value can be either 0 or 30-8640000 seconds.

5.1.3 Wireless Advanced Settings

Wireless Advanced Settings		
Beacon Interval:	100	ms (40-100)
DTIM Period:	1	(1-255)
RTS Threshold:	2347	(1-2347)
Fragmentation Threshold:	2346	(256-2346, works only in 11b/g mode)

Save

Figure 5-8 Wireless Advanced Settings

Beacon Interval: Beacons are transmitted periodically by the device to announce the presence of a wireless network for the clients. Beacon Interval value determines the time interval of the beacons sent by the device. You can specify a value from 40 to 100. The default value is 100 milliseconds.

DTIM Period: This value indicates the number of beacon intervals between successive Delivery Traffic Indication Messages (DTIMs) and this number is included in each Beacon frame. A DTIM is contained in Beacon frames to indicate whether the access point has buffered broadcast and/or multicast data for the client devices. Following a Beacon frame containing a DTIM, the access point will release the buffered broadcast and/or multicast data, if any exists. You can specify the value between 1-255 Beacon Intervals. The default value is 1, indicating the DTIM Period is the same as Beacon Interval. An excessive DTIM period may reduce the performance of multicast applications. It is recommended to keep it by default.

RTS Threshold: When the RTS threshold is activated, all the stations and APs follow the Request to Send (RTS) protocol. When the station is to send packets, it will send a RTS to AP to inform the AP that it will send data. After receiving the RTS, the AP notices other stations in the same wireless network to delay their transmitting of data. At the same time, the AP inform the requesting station to send data. The value range is from 1 to 2347 bytes. The default value is 2347, which means that RTS is disabled.

Fragmentation Threshold: Specify the fragmentation threshold for packets. If the size of the packet is larger than the fragmentation threshold, the packet will be fragmented into several packets. Too low fragmentation threshold may result in poor wireless performance caused by the excessive packets. The recommended and default value is 2346 bytes.

5.1.4 Load Balance

By restricting the maximum number of clients accessing the EAPs, Load Balance helps to achieve rational use of network resources.



The screenshot shows a configuration panel titled "Load Balance". At the top, there is a toggle switch labeled "Load Balance:" with "ON" selected. Below it, there is a text input field labeled "Maximum Associated Clients:" containing the value "0". To the right of the input field, the range "(1-99)" is displayed. A "Save" button is located in the bottom right corner of the panel.

Figure 5-9 Load Balance

Load Balance: Disable by default. Click **ON** to enable the function. After enabling it, you can set a number for maximum associated clients to control the wireless access.

Maximum Associated Clients: Enter the number of clients to be allowed for connection to the EAP. The number ranges from 1 to 99.

5.2 Portal

Portal authentication enhances the network security by providing authentication service to the clients that just need temporary access to the wireless network. Such clients have to log into a web page to establish verification, after which they will access the network as guests. What's more, you can customize the authentication login page and specify a URL which the newly authenticated clients will be redirected to. Please refer to [Portal Configuration](#) or [Free Authentication Policy](#) according to your need.

Following is the page of *Portal*.

Portal Configuration

Authentication Type: No Authentication

Authentication Timeout: 1 Hours

Redirect: Enable

Redirect URL:

Portal Customization: Local Web Portal

Term of Use:

I accept the Term of Use

Login

Save

Free Authentication Policy

+ Add

ID	Policy Name	Source IP Range	Destination IP Range	Source MAC	Destination Port	Status	Settings
--	--	--	--	--	--	--	--

Figure 5-10 Portal Page

NOTE:

To apply Portal in a wireless network, please go to **Wireless**→**Wireless Settings**→**SSIDs** to enable Portal of a selected SSID.

5.2.1 Portal Configuration

Three authentication types are available: No Authentication, Local Password and External RADIUS Server.

No Authentication: Users are required to finish only two steps: agree with the user protocol and click the **Login** button.

Local Password: Users are required to enter the preset password, which are saved in the EAP.

External RADIUS Server: Users are required to enter the preset user name and password, which are saved in the database of the RADIUS server. The RADIUS server acts as the authentication server, which allows you to set different usernames and passwords for different users.

Refer to the following content to configure Portal based on actual network situations.

- **No Authentication**

The screenshot shows the 'Portal Configuration' interface. The 'Authentication Type' is set to 'No Authentication'. The 'Authentication Timeout' is set to '1 Hours'. Below this, there are input fields for 'D', 'H', and 'M'. The 'Redirect' checkbox is unchecked. The 'Redirect URL' field is empty. The 'Portal Customization' is set to 'Local Web Portal'. A preview window shows a login form with a 'Term of Use' section, a checked checkbox 'I accept the Term of Use', and a 'Login' button. A 'Save' button is located at the bottom right of the configuration area.

Figure 5-11 Portal Configuration_No Authentication

Authentication Type: Select **No Authentication**.

Authentication Timeout: After successful verification, an authentication session is established. Authentication Timeout decides the active time of the session. Within the active time, the device keeps the authentication session open with the associated client. To reopen the session, the client needs to log in in the web authentication page and enter the user name and password again once authentication timeout is reached.

By default, authentication timeout is one hour. Select **Custom** from the drop-down list to customize the parameter.

Redirect: Disable by default. Redirect specifies that the portal should redirect the newly authenticated clients to the configured URL.

Redirect URL: If you enable the Redirect function, please enter the URL that a newly authenticated client will be directed to.

Portal Customization: Select Local Web Portal, the authentication login page will be provided by the built-in web server.

The page configured below will be presented to users as the login page. Words can be filled in Input Box 1 and Input Box 2.

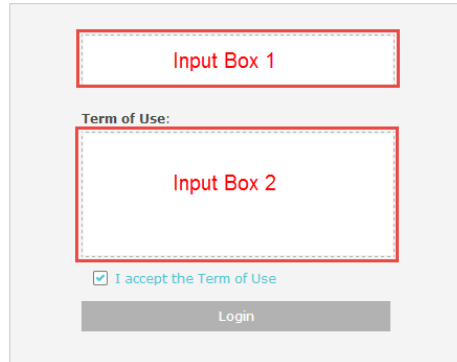

The image shows a login page layout. At the top is a rectangular input box labeled "Input Box 1". Below it is the text "Term of Use:" followed by a larger rectangular input box labeled "Input Box 2". Underneath the second input box is a checkbox with the text "I accept the Term of Use". At the bottom of the form is a grey button labeled "Login".

Enter up to 31 characters as the title of the authentication login page in Input Box 1, like "Guest Portal of TP-Link".

Enter the terms presented to users in Input Box 2. The terms can be 1 to 1023 characters long.

- **Local Password**

Portal Configuration

Authentication Type: Local Password

Password: [Text Field]

Authentication Timeout: 1 Hours

[Spinner] D [Spinner] H [Spinner] M

Redirect: Enable

Redirect URL: [Text Field]

Portal Customization: Local Web Portal

Preview:

[Text Field]

Password: [Text Field]

Term of Use:

[Text Field]

I accept the Term of Use

Login

Save

Figure 5-12 Portal Configuration_Local Password

Authentication Type: Select **Local Password**.

Password: Enter the password for local authentication.

Please refer to [No Authentication](#) to configure **Authentication Timeout**, **Redirect**, **Redirect URL** and **Portal Customization**.

- **External RADIUS Server**

External RADIUS Server provides two types of portal customization: Local Web Portal and External Web Portal. The authentication login page of **Local Web Portal** is provided by the built-in portal server of the EAP, as Figure 5-13 shown. The authentication login page of **External Web Portal** is provided by external portal server, as Figure 5-14 shown.

1. Local Web Portal

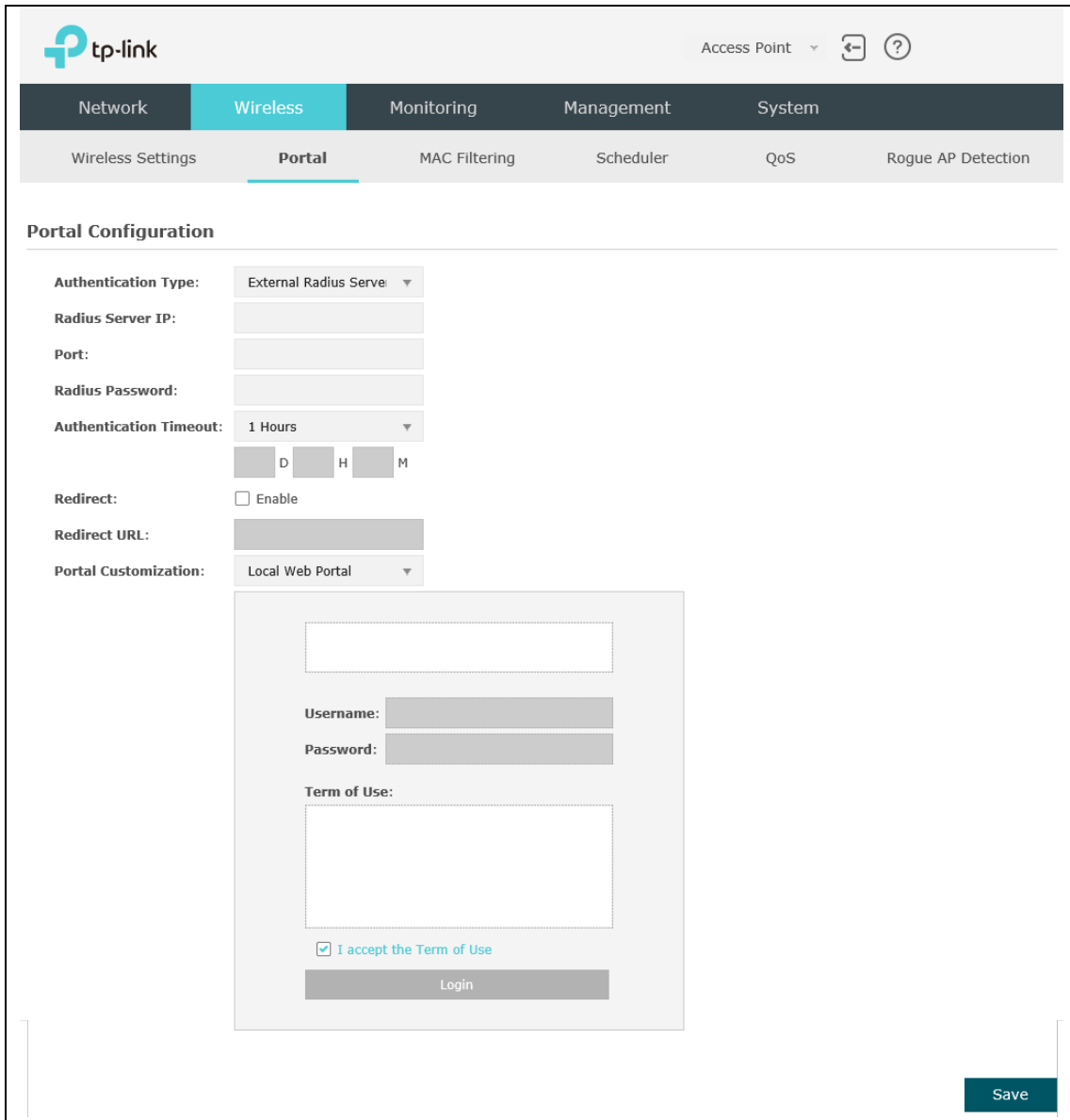

Figure 5-13 Portal Configuration_External RADIUS Server_Local Web Portal

Authentication Type: Select **External RADIUS Server**.

RADIUS Server IP: Enter the IP address of the RADIUS server.

Port: Enter the port for authentication service.

RADIUS Password: Enter the shared secret of RADIUS server to log in to the RADIUS server.

Please refer to [No Authentication](#) to configure **Authentication Timeout**, **Redirect**, **Redirect URL** and **Portal Customization**.

2. External Web Portal

Portal Configuration

Authentication Type: External Radius Server ▼

Radius Server IP:

Port:

Radius Password:

Authentication Timeout: 1 Hours ▼

D H M

Redirect: Enable

Redirect URL:

Portal Customization: External Web Portal ▼

External Web Portal URL:

Save

Figure 5-14 Portal Configuration_External RADIUS Server_External Web Portal

-
- Authentication Type:** Select **External RADIUS Server**.
-
- RADIUS Server IP:** Enter the IP address of the RADIUS server.
-
- Port:** Enter the port for authentication service.
-
- RADIUS Password:** Enter the shared secret of RADIUS server to log in to the RADIUS server.
-
- Portal Customization:** Select **External Web Portal**.
-
- External Web Portal URL:** Enter the authentication login page's URL, which is provided by the remote portal server.
-

Please refer to [No Authentication](#) to configure **Authentication Timeout**, **Redirect** and **Redirect URL**.

5.2.2 Free Authentication Policy

Free Authentication Policy allows clients to access network resources for free. On the lower part of the Portal page you can configure and view free authentication policies.

Free Authentication Policy

[+ Add](#)

ID	Policy Name	Source IP Range	Destination IP Range	Source MAC	Destination Port	Status	Settings
--	--	--	--	--	--	--	--

Figure 5-15 Free Authentication Policy

Click  **Add** to add a new authentication policy and configure its parameters.

Free Authentication Policy  Add

ID	Policy Name	Source IP Range	Destination IP Range	Source MAC	Destination Port	Status	Settings
--	--	--	--	--	--	--	--

Policy Name:

Source IP Range: / (Optional)

Destination IP Range: / (Optional)

Source MAC: (Optional)

Destination Port: (Optional)

Status: **Enable**

Figure 5-16 Configure Free Authentication Policy

Policy Name: Enter a policy name.

Source IP Range: Enter the source IP address and subnet mask of the clients who can enjoy the free authentication policy. Leaving the field empty means all IP addresses can access the specific resources.

Destination IP Range: Enter the destination IP address and subnet mask for free authentication policy. Leaving the field empty means all IP addresses can be visited. When **External Radius Server** is configured and **External Web Portal** is selected, please set the IP address and subnet mask of your external web server as the **Destination IP Range**.

Source MAC: Enter the source MAC address of the clients who can enjoy the free authentication policy. Leaving the field empty means all MAC addresses can access the specific resources.

Destination Port: Enter the destination port for free authentication policy. Leaving the field empty means all ports can be accessed.

Status: Check the box to enable the policy.

Click the button **OK** in Figure 5-16 and the policy is successfully added as Figure 5-17 shows.

Free Authentication Policy							
ID	Policy Name	Source IP Range	Destination IP Range	Source MAC	Destination Port	Status	Settings
1	Policy1	192.168.2.0/24	10.10.10.0/24	--	--	Enable	

Figure 5-17 Add Free Authentication Policy

Here is the explanation of Figure 5-17: The policy name is Policy 1. Clients with IP address range 192.168.2.0/24 are able to visit IP range 10.10.10.0/24. Policy 1 is enabled. Click to edit the policy. Click to delete the policy.

5.3 MAC Filtering

MAC Filtering uses MAC addresses to determine whether one host can access the wireless network. Thereby it can effectively control the user access to the wireless network.

tp-link Access Point

Network **Wireless** Monitoring Management System

Wireless Settings Portal **MAC Filtering** Scheduler QoS Rogue AP Detection

Settings

Enable MAC Filtering: Enable Save

Station MAC Group

+ Create Groups

MAC Filtering Association

ID	SSID Name	Band	MAC Group Name	Action
1	TP-LINK_2.4GHz_C0A877	2.4GHz	None	Deny

Note:
Deny: Deny the access of the stations specified in the MAC group.
Allow: Allow the access of the stations specified in the MAC group. Save

Figure 5-18 MAC Filtering Page

- **Settings**

Enable MAC Filtering: Check the box to enable MAC Filtering.

- **Station MAC Group**

Follow the steps below to add MAC groups.

Step 1:

Click  **Create Groups**, two tables will be shown.

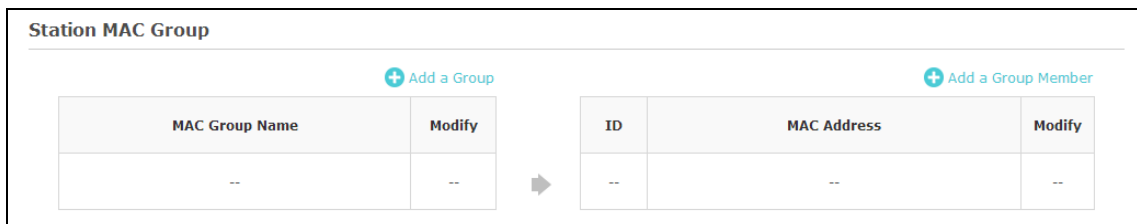



Figure 5-19 Station MAC Group

Step 2:

Click  **Add a Group** and fill in a name for the MAC group.

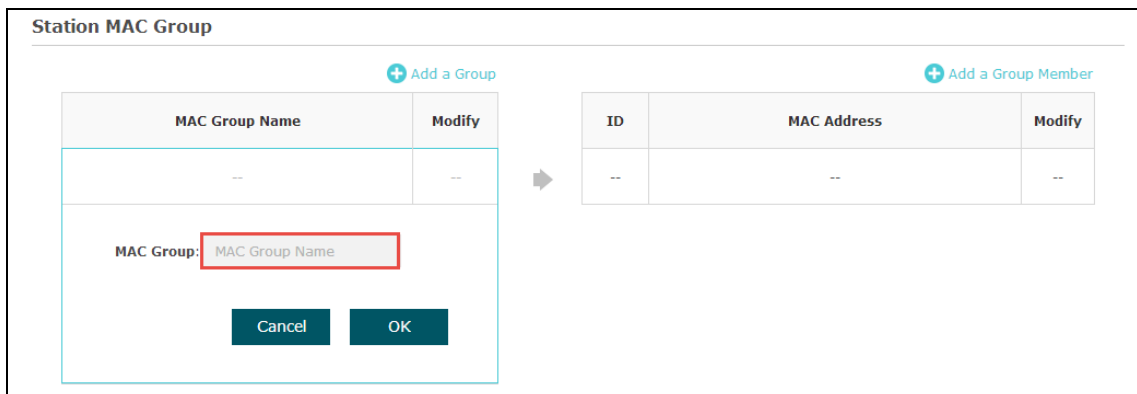



Figure 5-20 Add a Group

Step 3:

Select one MAC group, click  **Add a Group Member** and input the MAC address you want to organize into this group.

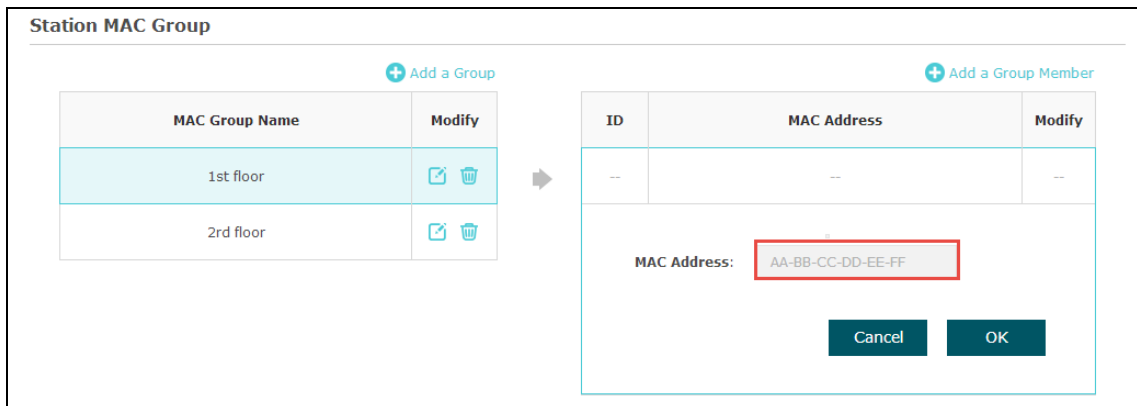



Figure 5-21 Add a Group Member

Click  in Modify column to edit the MAC group name or MAC address. Click  to delete the MAC group or group member.

• MAC Filtering Association

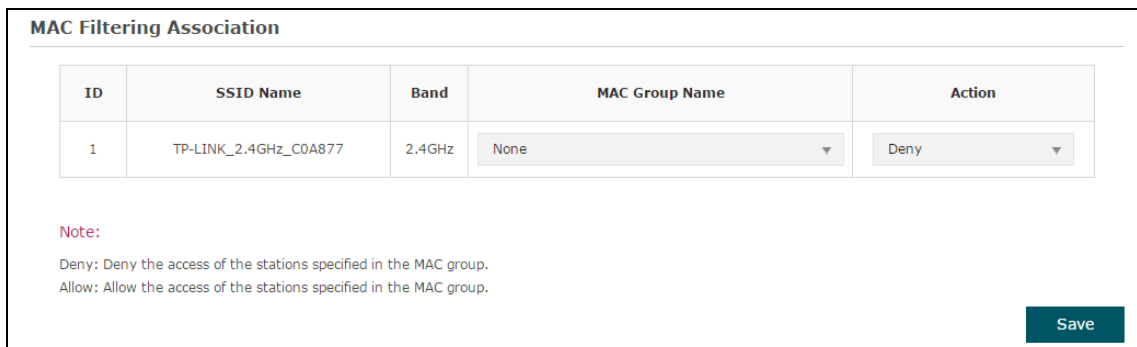

Figure 5-22 MAC Filtering Association

SSID Name: Displays the SSID of the wireless network.

Band: Displays the frequency band the wireless network operates at.

MAC Group Name: Select a MAC group from the drop-down list to allow or deny its members to access the wireless network.

Action:

- **Allow:** Allow the access of the stations specified in the MAC group.
- **Deny:** Deny the access of the stations specified in the MAC group.

5.4 Scheduler

Scheduler allows you to configure rules with specific time interval for radios to operate, which automates the enabling or disabling of the radio.

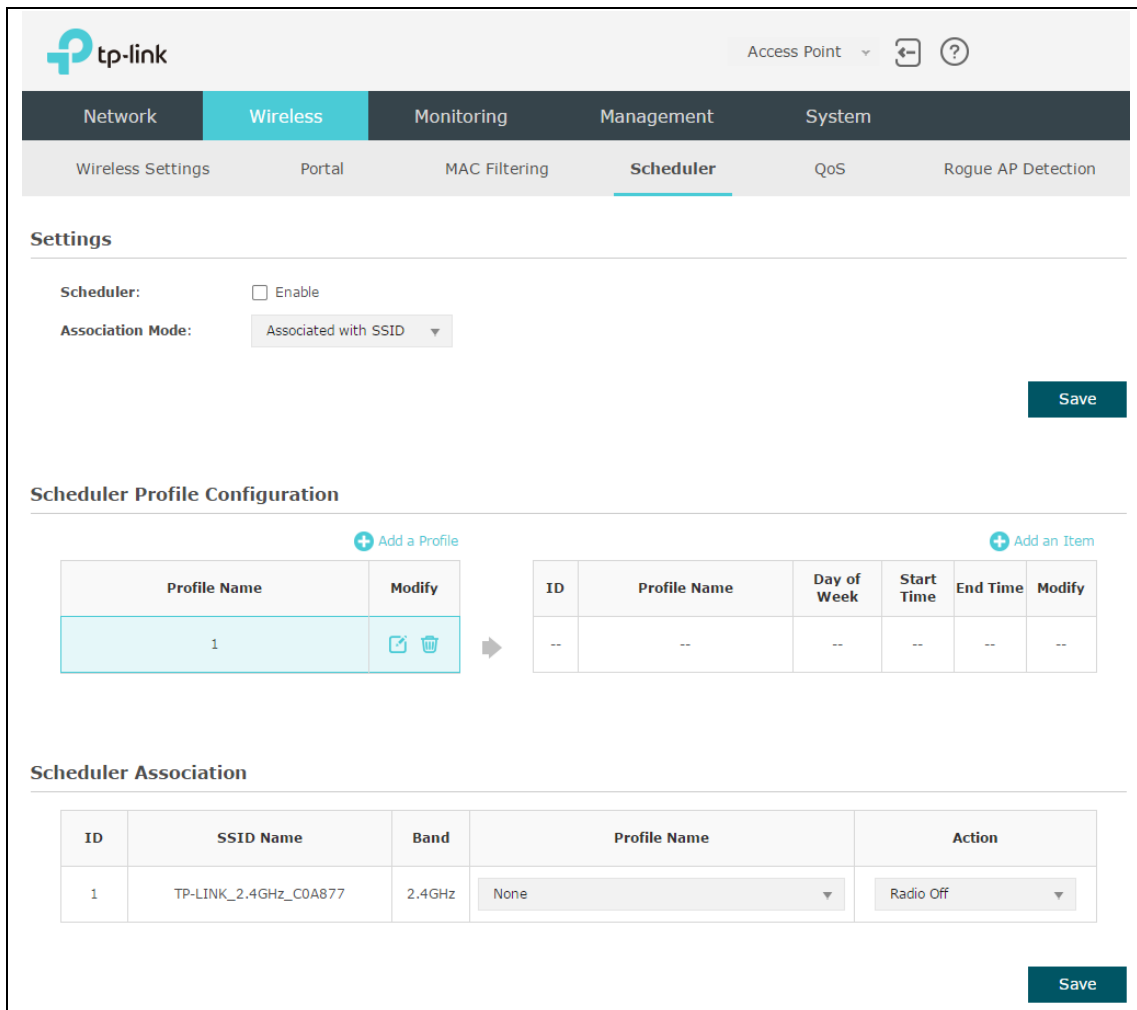

Figure 5-23 Scheduler Page

● Settings

Scheduler: Check the box to enable Scheduler.

Association Mode: Select **Associated with SSID/AP**, you can perform configurations on the SSIDs/AP. The display of Scheduler Association is based on your option here.

● Scheduler Profile Configuration

Follow the steps below to add rules.

Step 1:

Click  **Add a Profile** and input a profile name for the rule.

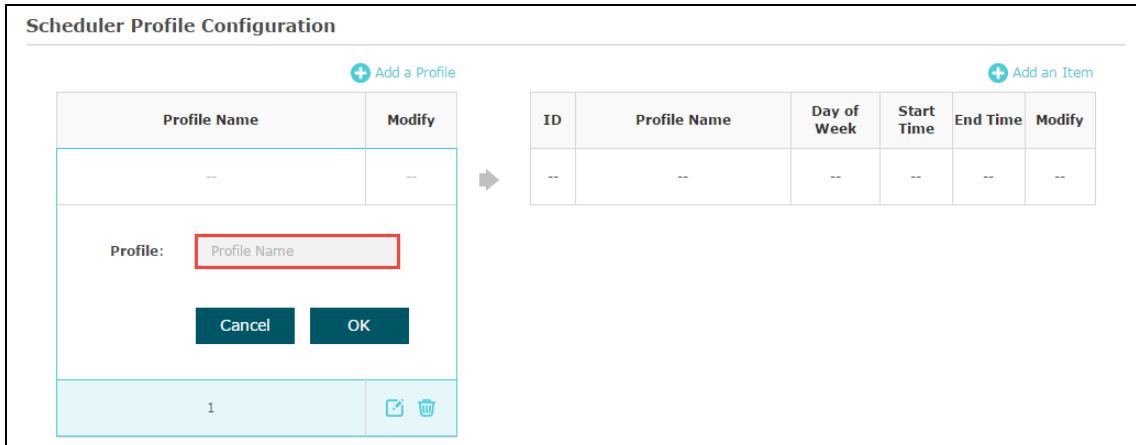

Figure 5-24 Add a Profile

Step 2:

Select one profile, and click [+ Add an Item](#) and configure the recurring schedule for the rule.

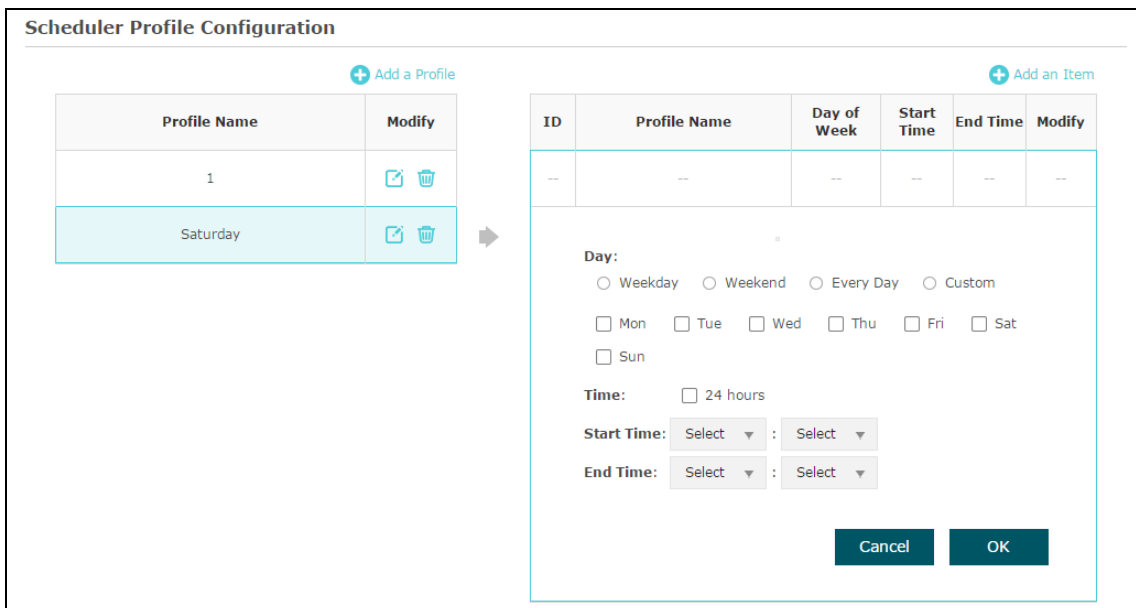

Figure 5-25 Add a Rule

- **Scheduler Association**

This zone will display different contents based on your selection of association mode in [Settings](#).

1. Associated with SSID

Scheduler Association				
ID	SSID Name	Band	Profile Name	Action
1	TP-LINK_2.4GHz_C0A877	2.4GHz	None	Radio Off

Save

Figure 5-26 Scheduler Association_Associated with SSID

SSID Name: Displays the SSID of the standalone AP.

Band: Displays the frequency band which the wireless network operates at.

Profile Name: Select a profile name from the drop-down list. Profile name is configured in Scheduler Profile Configuration.

Action: Select **Radio On/Off** to turn on/off the wireless network during the time interval set for the profile.

2. Associated with AP

Scheduler Association				
ID	AP	AP MAC	Profile Name	Action
1		00-00-00-00-00-00	Select options.	Radio off
2	EAP110-Outdoor-00-14-78-c0-a8-77	00-14-78-C0-A8-77	None	Radio off

Save

Figure 5-27 Scheduler Association_Associated with AP

AP: Displays the name of the device.

AP MAC: Displays the MAC address of the device.

Profile Name: Select a profile name from the drop-down list. Profile name is configured in Scheduler Profile Configuration.

Action: Select **Radio On/Off** to turn on/off the wireless network during the time interval set for the profile.

5.5 QoS

The EAP supports Quality of Service (QoS) to prioritize voice and video traffic over other traffic types. In normal use, we recommend you keep the default values for the EAP devices and station EDCA (Enhanced Distributed Channel Access).

tp-link Access Point

Network Wireless Monitoring Management System

Wireless Settings Portal MAC Filtering Scheduler QoS Rogue AP Detection

Wi-Fi Multimedia (WMM): Enable

AP EDCA Parameters

Queue	Arbitration Inter-Frame Space	Minimum Contention Window	Maximum Contention Window	Maximum Burst
Data 0(Voice)	1	3	7	1504
Data 1(Video)	1	7	15	3008
Data 2(Best Effort)	3	15	63	0
Data 3(Background)	7	15	1023	0

Station EDCA Parameters

Queue	Arbitration Inter-Frame Space	Minimum Contention Window	Maximum Contention Window	TXOP Limit
Data 0(Voice)	2	3	7	1504
Data 1(Video)	2	7	15	3008
Data 2(Best Effort)	3	15	1023	0
Data 3(Background)	7	15	1023	0

No Acknowledgement: Enable

Unscheduled Automatic Power Save Delivery: Enable

Save

Figure 5-28 QoS Page

Wi-Fi Multimedia (WMM): By default, WMM is enabled. After WMM is enabled, the device has the QoS function to guarantee the transmission of audio and video packets with high priority.

5.5.1 AP EDCA Parameters

AP Enhanced Distributed Channel Access (EDCA) parameters affect traffic flowing from the EAP device to the client station.

AP EDCA Parameters				
Queue	Arbitration Inter-Frame Space	Minimum Contention Window	Maximum Contention Window	Maximum Burst
Data 0(Voice)	1	3	7	1504
Data 1(Video)	1	7	15	3008
Data 2(Best Effort)	3	15	63	0
Data 3(Background)	7	15	1023	0

Figure 5-29 AP EDCA Parameters

Queue: Queue displays the transmission queue. By default, the priority from high to low is Data 0, Data 1, Data 2, and Data 3. The priority may be changed if you reset the EDCA parameters.

Data 0 (Voice)—Highest priority queue, minimum delay. Time-sensitive data such as VoIP and streaming media are automatically sent to this queue.

Data 1 (Video)—High priority queue, minimum delay. Time-sensitive video data is automatically sent to this queue.

Data 2 (Best Effort)—Medium priority queue, medium throughput and delay. Most traditional IP data is sent to this queue.

Data 3 (Background)—Lowest priority queue, high throughput. Bulk data that requires maximum throughput and is not time-sensitive is sent to this queue (FTP data, for example).

Arbitration Inter-Frame Space: A wait time for data frames. The wait time is measured in slots. Valid values for **Arbitration Inter-Frame Space** are from 1 to 15.

Minimum Contention Window: A list to the algorithm that determines the initial random backoff wait time (window) for retry of a transmission. This value can not be higher than the value for the **Maximum Contention Window**.

Maximum Contention Window: The upper limit (in milliseconds) for the doubling of the random backoff value. This doubling continues until either the data frame is sent or the Maximum Contention Window size is reached. This value must be higher than the value for the **Minimum Contention Window**.

Maximum Burst The **Maximum Burst** is a AP EDCA parameter that applies only to traffic flowing from the EAP devices to the client station. This value specifies (in milliseconds) the maximum burst length allowed for packet bursts on the wireless network. A packet burst is a collection of multiple frames transmitted without header information. The decreased overhead results in higher throughput and better performance.

The valid values are multiples of 32 between 0 and 8192.

5.5.2 Station EDCA Parameters

Station EDCA parameters affect traffic flowing from the client station to the EAP device.

Station EDCA Parameters				
Queue	Arbitration Inter-Frame Space	Minimum Contention Window	Maximum Contention Window	TXOP Limit
Data 0(Voice)	2	3 ▼	7 ▼	1504
Data 1(Video)	2	7 ▼	15 ▼	3008
Data 2(Best Effort)	3	15 ▼	1023 ▼	0
Data 3(Background)	7	15 ▼	1023 ▼	0

No Acknowledgement: Enable

Unscheduled Automatic Power Save Delivery: Enable

Figure 5-30 Station EDCA Parameters

Queue:

Queue displays the transmission queue. By default, the priority from high to low is Data 0, Data 1, Data 2, and Data 3. The priority may be changed if you reset the EDCA parameters.

Data 0 (Voice)—Highest priority queue, minimum delay. Time-sensitive data such as VoIP and streaming media are automatically sent to this queue.

Data 1 (Video)—High priority queue, minimum delay. Time-sensitive video data is automatically sent to this queue.

Data 2 (Best Effort)—Medium priority queue, medium throughput and delay. Most traditional IP data is sent to this queue.

Data 3 (Background)—Lowest priority queue, high throughput. Bulk data that requires maximum throughput and is not time-sensitive is sent to this queue (FTP data, for example).

Arbitration Inter-Frame Space:

A wait time for data frames. The wait time is measured in slots. Valid values for **Arbitration Inter-Frame Space** are from 0 to 15.

Minimum Contention Window:

A list to the algorithm that determines the initial random backoff wait time (window) for retry of a transmission. This value can not be higher than the value for the **Maximum Contention Window**.

Maximum Contention Window:

The upper limit (in milliseconds) for the doubling of the random backoff value. This doubling continues until either the data frame is sent or the Maximum Contention Window size is reached.

This value must be higher than the value for the **Minimum Contention Window**.

TXOP Limit:	The TXOP Limit is a station EDCA parameter and only applies to traffic flowing from the client station to the EAP device. The Transmission Opportunity (TXOP) is an interval of time, in milliseconds, when a WME client station has the right to initiate transmissions onto the wireless medium (WM) towards the EAP device. The valid values are multiples of 32 between 0 and 8192.
No Acknowledgement:	Select Enable to specify that the EAP device should not acknowledge frames with QoSNoAck as the service class value. By default, it is disabled.
Unscheduled Automatic Power Save Delivery:	Select Enable to enable APSD, which is a power management method. APSD is recommended if VoIP phones access the network through the EAP device. By default, it is enabled.

5.6 Rogue AP Detection

A Rogue AP is an access point that has been installed on a secure network without explicit authorization from a system administrator.

The EAP device can scan all channels to detect all APs in the vicinity of the network. If rogue APs are detected, they are shown on the *Detected Rogue AP List*. If an AP listed as a rogue is legitimate, you can add it to the *Trusted AP List*.

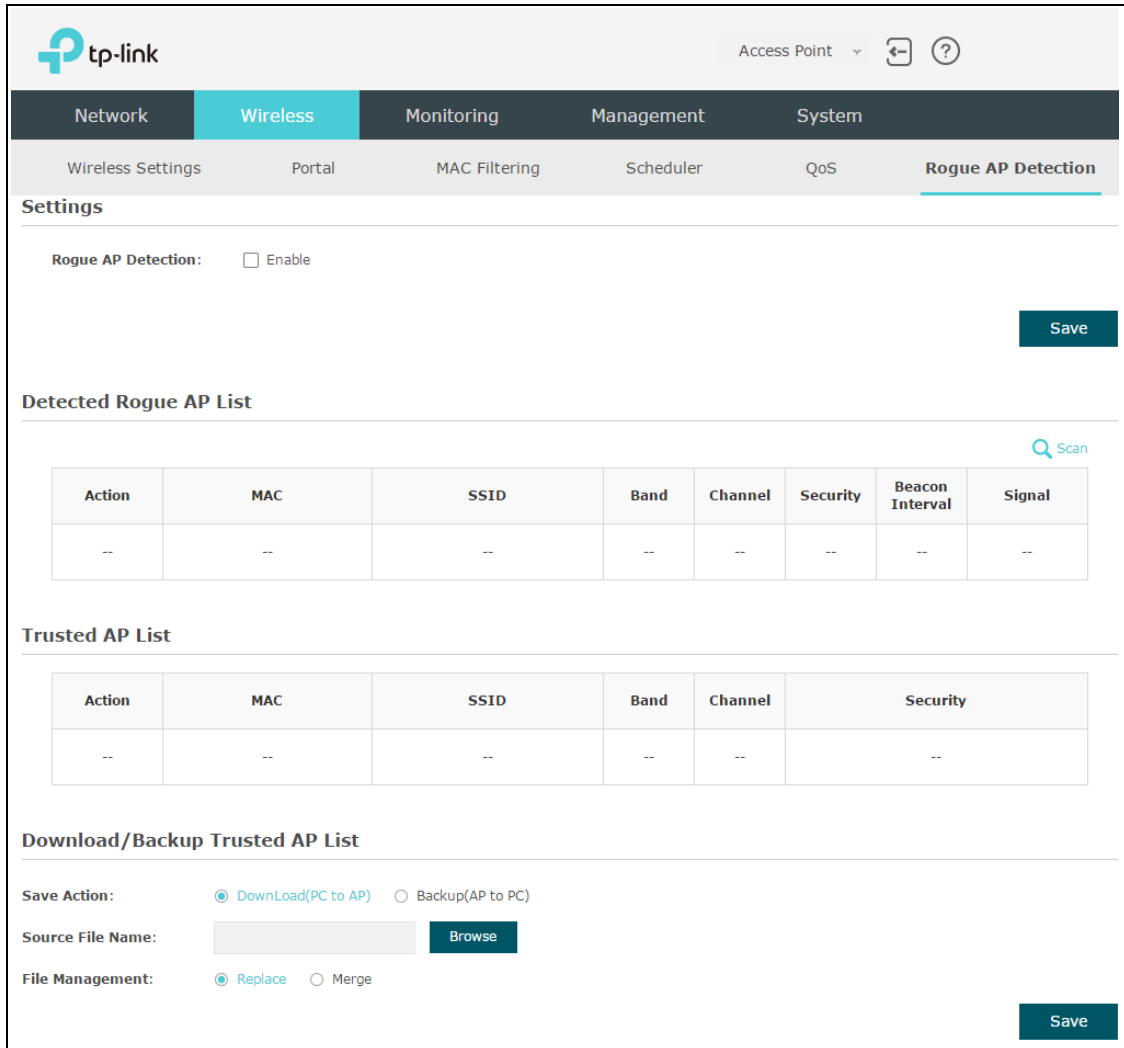

Figure 5-31 Rogue AP Detection Page

5.6.1 Settings



Figure 5-32 Enable Rogue AP Detection

Rogue AP Detection: Check the box to enable Rogue AP Detection, then click **Save**.

5.6.2 Detected Rogue AP List

Information about the detected rogue APs is displayed in the list. By default, the status of the detected rogue AP is unknown. You can click **Known** in Action column to move the AP to the Trusted AP List.



Detected Rogue AP List							
Action	MAC	SSID	Band	Channel	Security	Beacon Interval	Signal
Known	00:EA:DE:AD:BE:E0	TP-LINK_2.4GHZ_ADBEE0	2.4	12	OFF	100	
Known	98:DE:D0:BB:D3:52	TP-LINK_AP_17	2.4	3	ON	100	

Figure 5-33 Detected Rogue AP List



Click to scan rogue APs. Make sure you have enabled Rogue AP Detection and saved the setting before you click the button.

Action: Click **Known** to move the AP to the Trusted AP List. After the configurations are saved, the moved AP will not be displayed in the Detected Rogue AP List.

MAC: The MAC address of the rogue AP.

SSID: The SSID of the rogue AP.

Band: Displays the frequency band which the wireless network of the rogue AP operates at.

Channel: The channel on which the rogue AP is currently broadcasting.

Security: Displays the enabling or disabling of the security mode of the wireless network.

Beacon Interval: The beacon interval used by the rogue AP. Beacon frames are transmitted by an AP at regular intervals to announce the existence of the wireless network. The default behavior is to send a beacon frame once every 100 milliseconds (or 10 per second).

Signal: The strength of the radio signal emitting from the rogue AP.

5.6.3 Trusted AP List

Information about the trusted APs is displayed in the list.

Trusted AP List					
Action	MAC	SSID	Band	Channel	Security
Unknown	60:E3:27:E8:5A:98	TP-LINK_E85A98	2.4	1	ON
Unknown	E8:94:F6:79:B1:E0	TP-LINK_2.4GHZ_H5R	2.4	11	ON

Figure 5-34 Trusted AP List

Action:	Click Unknown to move the AP out of the Trusted AP List.
MAC:	The MAC address of the trusted AP.
SSID:	The SSID of the trusted AP.
Band:	Displays the frequency band which the wireless network of the trusted AP operates at.
Channel:	The channel on which the trusted AP is currently broadcasting.
Security:	Displays the enabling or disabling of the security mode of the wireless network.

5.6.4 Download/Backup Trusted AP List

You can import a list of trusted APs from a saved list which is acquired from another AP or created from a text file. The AP whose MAC address is in the Trusted AP List will not be detected as a rogue.

You can also backup a list and save it in your PC.

Figure 5-35 Download/Backup Trusted AP List

Save Action:	Select Download (PC to AP) to import a trusted AP list to the device. Select Backup (AP to PC) to copy the trusted AP list to your PC.
Source File Name:	Click Browse and choose the path of a saved trusted AP list or to save a trusted AP list.
File Management:	Select Replace to import the list and replace the contents of the Trusted AP List. Select Merge to import the list and add the APs in the imported file to the APs currently shown in the Trusted AP List

NOTE:

EAP device does not have any control over the APs in the Detected Rogue AP List.

Chapter 6 Monitoring

On **Monitoring** page, you can monitor the network running status and statistics based on AP, SSID and Client.

6.1 AP

AP List on the **Monitoring** page displays the device name, its MAC address and the number of clients. Below the AP List the AP's detailed information will be shown, including [Device Information](#), [Wireless Settings](#), [LAN Information](#), [Client](#), [LAN Traffic](#) and [Radio Traffic](#).

The screenshot shows the TP-Link web interface. At the top, there is a navigation bar with tabs for Network, Wireless, Monitoring (selected), Management, and System. Below this, there are sub-tabs for AP, SSID, and Client. The main content area is titled 'AP List' and features a table with the following data:

ID	Device Name	MAC	Num of Clients
1	EAP110-Outdoor-00-14-78-c0-a8-77	00:14:78:C0:A8:77	0

Below the table, there are links for Device Information, Wireless Settings, LAN Information, Client, LAN Traffic, and Radio Traffic. The detailed information for the selected AP is as follows:

- Device Name: EAP110-Outdoor-00-14-78-c0-a8-77
- Device Model: EAP110-Outdoor
- Firmware Version: 1.0.0 Build 20160809 Rel. 45933
- System Time: 2014-01-01 00:20:10
- Uptime: 0 days 00:20:11
- CPU: 2% (represented by a progress bar)
- Memory: 66% (represented by a progress bar)

Figure 6-1 AP Monitoring

6.1.1 AP List

This screenshot shows a close-up of the 'AP List' table from the previous figure. It contains one row of data:

ID	Device Name	MAC	Num of Clients
1	EAP110-Outdoor-00-14-78-c0-a8-77	00:14:78:C0:A8:77	0

Figure 6-2 AP List

Device Name:	Displays the device name.
MAC:	Displays the MAC address of the EAP.
Num of Clients:	Displays the number of clients connected to the EAP.

- **Device Information**

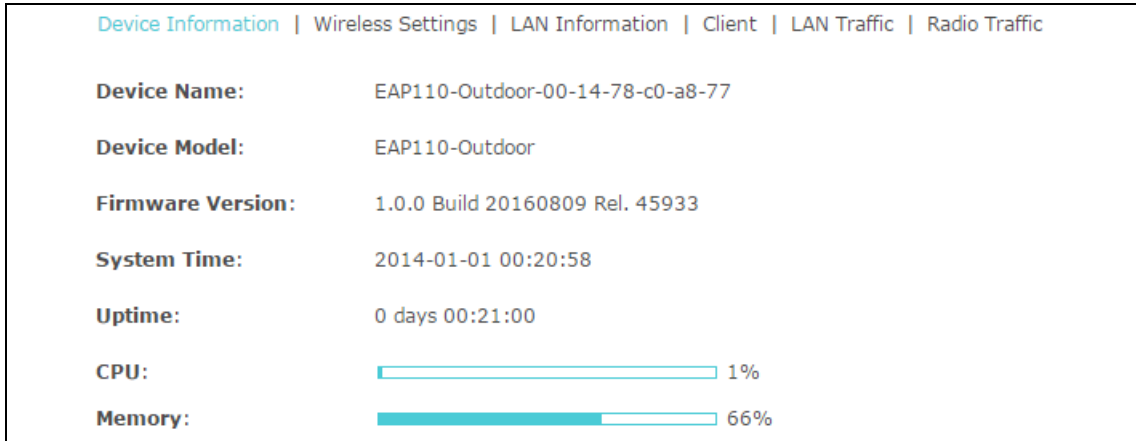

Figure 6-3 Device Information

Device Name:	Displays the device name.
Device Model:	Displays the model of the device.
Firmware Version:	Displays the firmware version of the device. If you want to upgrade the firmware, please refer to 8.5 Firmware Upgrade .
System Time:	Displays the system time of the device. If you want to adjust the system time, please refer to 8.2.1 Time Settings .
Uptime:	Displays the time that has elapsed since the last reboot.
CPU:	Displays the CPU occupancy, which helps you to preliminarily judge whether the device functions properly.
Memory:	Displays the memory usage, which helps you to preliminarily judge whether the device functions properly.

• Wireless Settings

Device Information Wireless Settings LAN Information Client LAN Traffic Radio Traffic	
Channel/Frequency:	4 / 2427MHz
Channel Width:	20/40MHz
IEEE802.11 Mode:	b/g/n mixed
Max TX Rate:	300.0Mbps
Transmit Power:	20dBm

Figure 6-4 Wireless Settings

Channel/Frequency : Displays the channel number and the operating frequency. If you want to change them, please refer to [5.1.1 Wireless Basic Settings](#).

Channel Width: Displays the spectral width of the radio channel used by the device. If you want to change it, refer to [5.1.1 Wireless Basic Settings](#).

IEEE802.11 Mode: Displays the radio standard used for operation of your device. If you want to change it, refer to [5.1.1 Wireless Basic Settings](#).

Max TX Rate: Displays the maximum data rate at which the device should transmit wireless packets.

Transmit Power: Displays the maximum average transmit power of the device. If you want to change it, refer to [5.1.1 Wireless Basic Settings](#).

• LAN Information

Device Information Wireless Settings LAN Information Client LAN Traffic Radio Traffic	
MAC Address:	00-14-78-C0-A8-77
IP Address:	192.168.0.254
Subnet Mask:	255.255.255.0
LAN Port:	100Mbps - FD

Figure 6-5 LAN Information

MAC Address: Displays the MAC address of the device.

IP Address: Displays the IP address of the device.

Subnet Mask: Displays the subnet mask of the device.

LAN Port: Displays the maximum transmission rate and duplex mode (half-duplex or full-duplex) of the port.

• Client

ID	MAC	Band	SSID	SNR(dB)	CCQ(%)	Rate(Mbps)	Down(Byte)	Up(Byte)	Active Time
--	--	--	--	--	--	--	--	--	--

Figure 6-6 Client

MAC: Displays the MAC address of the client of the AP selected in AP List.

SSID: Displays the SSID the client is connected to.

SNR(dB): Signal to Noise Ratio, the power ratio between the received wireless signal strength and the environmental noise strength. The bigger the value of SNR is, the better network performance the device provides.

CCQ(%): Displays the wireless Client Connection Quality (CCQ). CCQ refers to the ratio of current effective transmission bandwidth and the theoretically maximum available bandwidth. CCQ reflects the actual link condition.

Rate(Mbps): Displays the data rate at which the client transmits wireless packets.

Down(Byte): Displays the throughput of the downstream data.

Up(Byte): Displays the throughput of the upstream data.

Active Time: Displays the amount of time the client has been connected to the device.

• LAN Traffic

Click **LAN Traffic** and you can monitor the data transmission status of the LAN port.

Device Information Wireless Settings LAN Information Client LAN Traffic Radio Traffic			
Rx Packets:	4655	Tx Packets:	4843
Rx Bytes:	522686	Tx Bytes:	2800594
Rx Dropped Packets:	284	Tx Dropped Packets:	0
Rx Errors:	0	Tx Errors:	0

Figure 6-7 LAN Traffic

Rx/Tx Packets:	Displays the total amount of packets received/sent on the LAN port.
Rx/Tx Bytes:	Displays the total amount of data (in bytes) received/sent on the LAN port.
Rx/Tx Dropped Packets:	Displays the total amount of dropped packets received/sent on the LAN port.
Rx/Tx Errors:	Displays the total amount of error packets received/sent-on the LAN port.

- **Radio Traffic**

Click **Radio Traffic** and you can monitor the data transmission status of the wireless network.

Device Information Wireless Settings LAN Information Client LAN Traffic Radio Traffic			
Rx Packets:	22124	Tx Packets:	31927
Rx Bytes:	3077351	Tx Bytes:	182958
Rx Dropped Packets:	0	Tx Dropped Packets:	0
Rx Errors:	0	Tx Errors:	0

Figure 6-8 Radio Traffic

Rx/Tx Packets:	Displays the total amount of packets received/sent by the wireless network.
Rx/Tx Bytes:	Displays the total amount of data (in bytes) received/sent by the wireless network.
Rx/Tx Dropped Packets:	Displays the total amount of dropped packets received/sent by the wireless network.
Rx/Tx Errors:	Displays the total amount of error packets received/sent by the wireless network.

6.2 SSID

ID	SSID Name	VLAN ID	Num of Clients	SSID Broadcast	Band	Security	Portal	MAC Filtering	Isolation	Down(Byte)	Up(Byte)
1	TP-LINK_2.4GHz_C0A877	0	0	enable	2.4GHz	none	disable	disable	disable	6k	2k

Figure 6-9 SSID Monitoring

6.2.1 SSID List

In *SSID List* you can monitor the related parameters of the wireless network.

ID	SSID Name	VLAN ID	Num of Clients	SSID Broadcast	Band	Security	Portal	MAC Filtering	Isolation	Down(Byte)	Up(Byte)
1	TP-LINK_2.4GHz_C0A877	0	0	enable	2.4GHz	none	disable	disable	disable	6k	2k

Figure 6-10 SSID List

SSID Name: Displays the SSID name. If you want to modify it, please refer to [5.1.2 SSIDs](#).

VLAN ID: Displays the VLAN which the SSID belongs to. If you want to change the VLAN ID, please refer to [5.1.2 SSIDs](#).

Num of Clients: Displays the number of clients connected to the SSID. If you want to get more information about these clients, please refer to [5.1.2 SSIDs](#).

SSID Broadcast: Displays the enabling or disabling of SSID broadcast. If you want to modify it, please refer to [5.1.2 SSIDs](#).

Band: Displays the frequency band the wireless network is operating at.

Security: Displays the security mode the wireless network is applying. If you want to modify it, please refer to [5.1.2 SSIDs](#).

Portal: Displays the enabling or disabling of Portal. If you want to modify it, please refer to [5.1.2 SSIDs](#).

MAC Filtering: Displays the enabling or disabling of MAC Filtering. If you want to modify it, please refer to [5.1.2 SSIDs](#).

Isolation: Displays the enabling or disabling of SSID Isolation. If you want to modify it, please refer to [5.1.2 SSIDs](#).

Down(Byte): Displays the throughput of the downstream data.

Up(Byte): Displays the throughput of the upstream data.

6.3 Client

From *User List*, you can monitor the status of all the clients connected to the EAP including those who are authenticated.

The screenshot shows the TP-Link web interface for Client Monitoring. The top navigation bar includes 'Network', 'Wireless', 'Monitoring' (selected), 'Management', and 'System'. Under 'Monitoring', there are sub-menus for 'AP', 'SSID', and 'Client'. The main content area is titled 'User List' and contains a table with the following columns: ID, MAC, Band, Access Point, SSID, SNR(dB), CCQ(%), Rate(Mbps), Down(Byte), Up(Byte), and Active Time. A 'Refresh' button is located to the right of the table. Below this, there is a section for 'Portal Authenticated Guest' with a similar table structure, including an 'Action' column and a 'Refresh' button.

Figure 6-11 Client Monitoring

6.3.1 User List

The screenshot shows the 'User List' table in the TP-Link web interface. The table has the following columns: ID, MAC, Band, Access Point, SSID, SNR(dB), CCQ(%), Rate(Mbps), Down(Byte), Up(Byte), and Active Time. A 'Refresh' button is located to the right of the table.

Figure 6-12 User List

MAC: Displays the MAC address of the client.

Band:	Displays the band the client is in.
Access Point:	Displays the name of the device to which the client is connected.
SSID:	Displays the SSID the client is connected to.
SNR(dB):	Signal to Noise Ratio, the power ratio between the received wireless signal strength and the environmental noise strength. The bigger the value of SNR, the better network performance the device provides.
CCQ(%):	Displays the wireless Client Connection Quality (CCQ). CCQ refers to the ratio of current effective transmission bandwidth and the theoretically maximum available bandwidth. CCQ reflects the actual link condition.
Rate(Mbps):	Displays the data rate at which the client transmits wireless packets.
Down(Byte):	Displays the throughput of the downstream data.
Up(Byte):	Displays the throughput of the upstream data.
Active Time:	Displays the amount of time the client has been connected to the device.

6.3.2 Portal Authenticated Guest

The *Portal Authenticated Guest* displays information about clients that have set up valid authentication.

Portal Authenticated Guest											
ID	MAC	Band	Access Point	SSID	SNR(dB)	CCQ(%)	Rate(Mbps)	Down(Byte)	Up(Byte)	Active Time	Action
--	--	--	--	--	--	--	--	--	--	--	--

Figure 6-13 Portal Authenticated Guest

MAC:	Displays the MAC address of the authenticated client.
Band:	Displays the band the authenticated client is in.
Access Point:	Displays the name of the device to which the authenticated client is connected
SSID:	Displays the SSID the authenticated client is connected to.
SNR(dB):	Signal to Noise Ratio, the power ratio between the received wireless signal strength and the environmental noise strength. The bigger the value of SNR, the better network performance the device provides.

CCQ(%): Displays the Client Connection Quality (CCQ) of the authenticated client. CCQ refers to the ratio of current effective transmission bandwidth and the theoretically maximum available bandwidth. CCQ reflects the actual link condition.

Rate(Mbps): Displays the data rate at which the authenticated client transmits wireless packets.

Down(Byte): Displays the throughput of the downstream data.

Up(Byte): Displays the throughput of the upstream data.

Active Time: Displays the amount of time the client has been authenticated on the root AP.

Action: Click **Unauthorize** to stop giving authorization to the clients connected to the wireless network.

Chapter 7 Management

Management page is mainly used for device management and maintenance.

7.1 System Log

System log records information about hardware, software as well as system issues and monitors system events. With the help of system log, you can get informed of system running status and detect the reasons for failure.

Following is the page of *System Log*.

The screenshot displays the TP-Link web interface for the System Log page. The top navigation bar includes the TP-Link logo, 'Access Point' dropdown, and icons for back and help. The main navigation menu has 'Management' selected, with sub-menus for 'System Log', 'Web Server', 'Management Access', 'LED ON/OFF', 'SSH', 'Management VLAN', and 'SNMP'. The 'System Log' section is active, showing a 'Log List' table and 'Log Settings'.

Index	Time	Type	Level	Log Content
3	2014-01-01 00:00:33	DHCP	NOTICE	DHCP DHCP Service unavailable, recv no OFFER
2	2014-01-01 00:00:32	OTHER	WARNING	LAN IP and mask changed to 192.168.0.254 255.255.255.0
1	1970-01-01 00:00:09	OTHER	INFO	System started

Log Settings

Enable Auto Mail: Auto Mail Feature

Enable Server: Enable Server

Enable Nvram: Enable Nvram

Save

Figure 7-1 System Log Page

7.1.1 Log List

From *Log List* you can view detailed information about hardware, software, system issues and so on.

Log List				
Index	Time	Type	Level	Log Content
3	2014-01-01 00:00:33	DHCP	NOTICE	DHCPC DHCP Service unavailable, recv no OFFER
2	2014-01-01 00:00:32	OTHER	WARNING	LAN IP and mask changed to 192.168.0.254 255.255.255.0
1	1970-01-01 00:00:09	OTHER	INFO	System started

Figure 7-2 Log List

7.1.2 Log Settings

You can choose the way to receive system logs in **Log Settings** zone, where these parameters can be configured: [Enable Auto Mail](#), [Enable Server](#) and [Enable Nvram](#).

Log Settings	
Enable Auto Mail:	<input type="checkbox"/> Auto Mail Feature
Enable Server:	<input type="checkbox"/> Enable Server
Enable Nvram:	<input type="checkbox"/> Enable Nvram
Save	

Figure 7-3 Log Settings

- **Enable Auto Mail**

If Auto Mail Feature is enabled, system logs will be sent to a mailbox. The following content will be shown.

Enable Auto Mail:	<input checked="" type="checkbox"/> Auto Mail Feature
From:	<input type="text"/>
To:	<input type="text"/>
SMTP Server:	<input type="text"/>
Enable Authentication:	<input type="checkbox"/> Enable Authentication
User Name:	<input type="text"/>
Password:	<input type="text"/>
Confirm Password:	<input type="text"/>
Time Mode:	<input checked="" type="radio"/> Fixation Time <input type="radio"/> Period Time
Fixation Time:	00 : 00 (HH:MM)

Figure 7-4 Enable Auto Mail

From: Enter the sender's email address.

To: Enter the recipient's email address, which will receive the system logs.

SMTP Server: Enter the IP address of the SMTP server.

Enable Authentication: Generally users are required to log in to the SMTP server by entering user name and password.

- **User Name:** Enter the sender's email address.
- **Password:** Enter the password of the sender's email address.
- **Confirm Password:** Enter the password again for confirmation.

Time Mode: System logs can be sent at specific time or time interval.

- **Fixation Time:** Set a fixed time, for example, 15:00. The recipient will receive the system logs sent by the device at 15:00 every day.
- **Period Time:** Set a time interval, for example, 5 hours. The recipient will receive the system logs sent by the device every 5 hours.

• Enable Server

System logs can also be sent to a server. After Enable Server is enabled, the following content will be shown.

Enable Server:	<input checked="" type="checkbox"/> Enable Server
System Log Server IP:	0.0.0.0
System Log Server Port:	514

Figure 7-5 Enable Server

System Log Server IP: Enter the IP address of the remote server.

System Log Server Port: Enter the port of the remote server.

• Enable Nvram

By default, Nvram is disabled. Check the box to enable Nvram, system logs will be saved after power supply is cut.

Nvram (Non-volatile Random Access Memory) is a RAM that can still save data even if a device is power off. All TP-Link EAPs are equipped with Nvram. With this option enabled, the Nvram feature can help reserve the system logs when an EAP device is power off.

7.2 Web Server

You can log in web management interface, thereby manage and maintain the device.

Following is the page of *Web Server*.

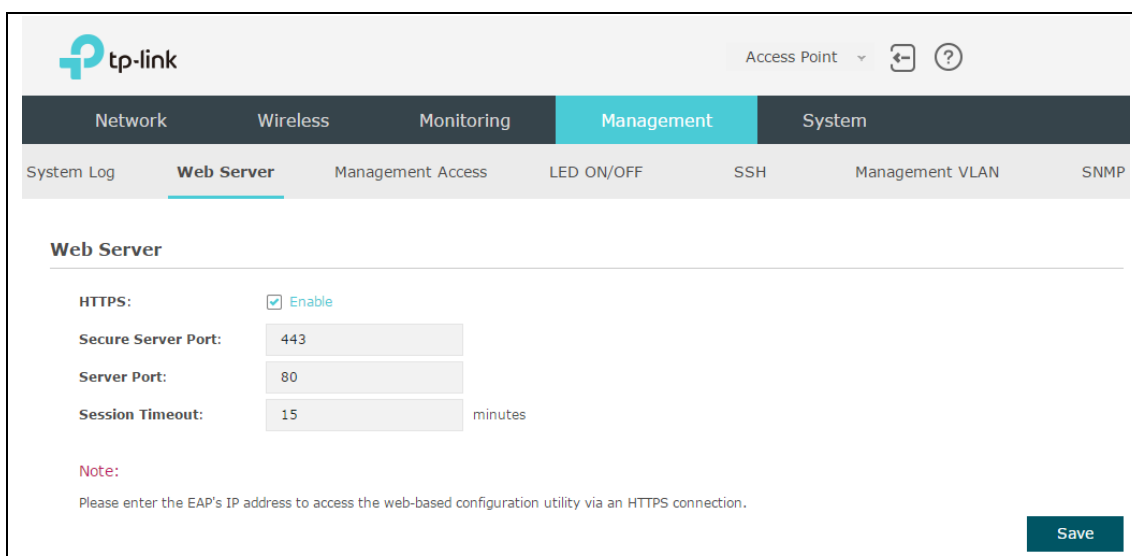

Figure 7-6 Web Server Page

HTTPS:	HTTPS (Hypertext Transfer Protocol Secure) is enabled by default.
Secure Server Port:	Designate a secure server port for web server in HTTPS mode. By default the port is 443.
Server Port:	Designate a server port for web server in HTTP mode. By default the port is 80.
Session Timeout:	Set the session timeout time. If you do nothing with the web management page within the timeout time, the system will log out automatically. Please login again if you want to go back to web management page.

7.3 Management Access

Management Access Control allows you to configure up to four MAC addresses of the hosts that are allowed to log in to the web management page of the EAP. Click **Add PC's MAC** and the MAC address of the current host will be added to MAC address list.

Following is the page of *Management Access*.

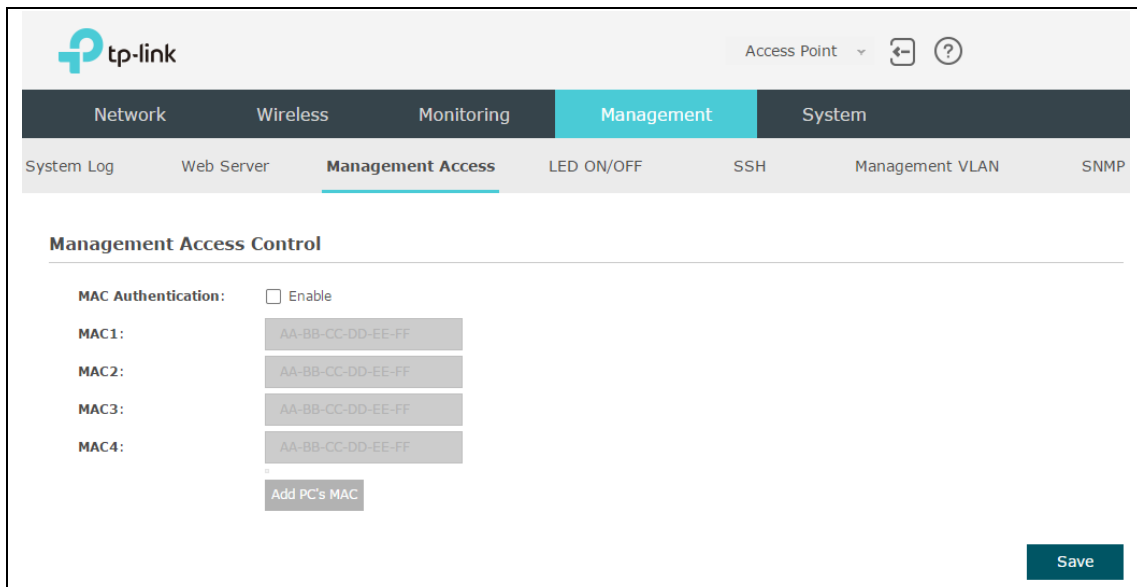

Figure 7-7 Management Access Page

MAC Authentication: Check the box to enable MAC Authentication. After MAC Authentication is enabled, only the PCs in MAC address list can log in the device's web management page. By default this function is disabled. All PCs in LAN can log in and manage the device.

MAC1-MAC4: Enter the MAC addresses of the PCs which are authorized to log in the device.

7.4 LED ON/OFF

Following is the page of *LED ON/OFF*. By default the LED is on.

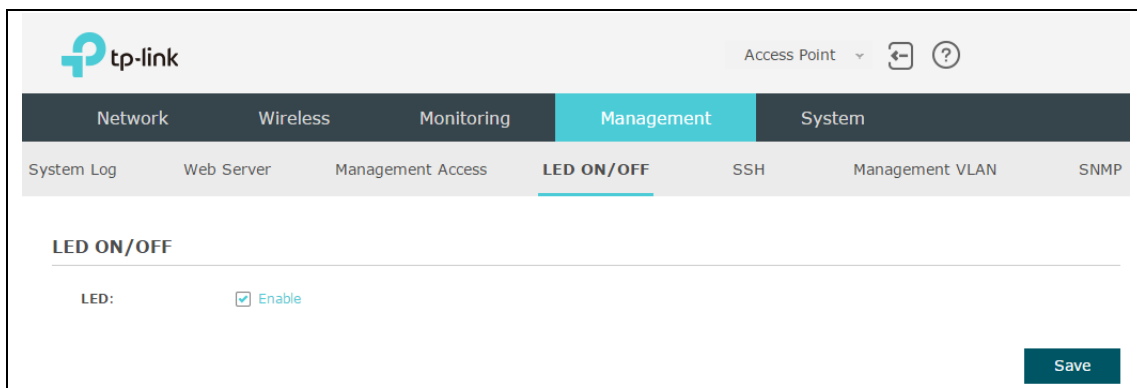

Figure 7-8 LED ON/OFF

7.5 SSH

This device supports the SSH Server function that allows users to login and manage it through SSH connection on the SSH client software.

SSH (Secure Shell) is a security protocol established on application and transport layers. SSH-encrypted-connection is similar to a telnet connection, but essentially the old telnet remote management method is not safe, because the password and data transmitted with plain-text can be easily intercepted. SSH can provide information security and powerful authentication when you login this device remotely through an insecure network environment. It can encrypt all the transmission data and prevent the information in remote management from being leaked.

Following is the page of **SSH**.

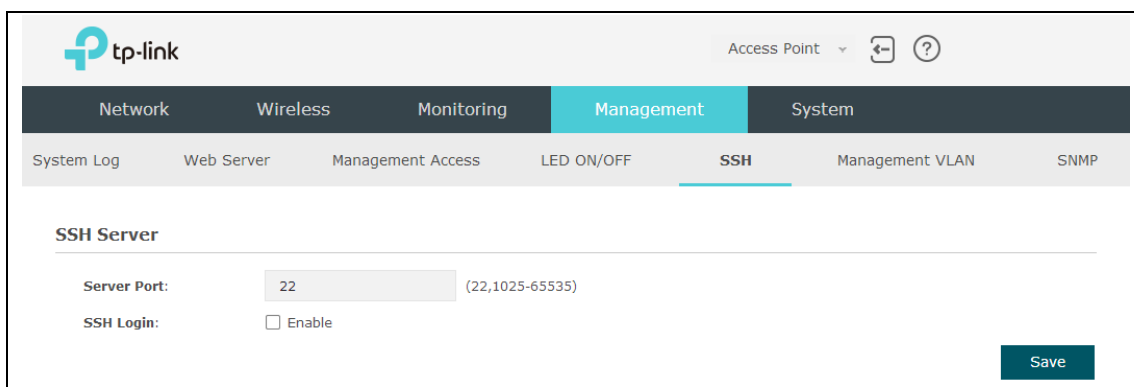

Figure 7-9 SSH Page

Server Port: Enter the server port. By default, it is port 22.

SSH Login: Check the box to enable SSH Server. By default, it is disabled.

7.6 Management VLAN

Management VLAN provides a safer way for you to manage the EAP. With Management VLAN enabled, only the hosts in the management VLAN can manage the EAP. Since most hosts cannot process VLAN TAGs, connect the management host to the network via a switch, and set up correct VLAN settings for the switches on the network to ensure the communication between the host and the EAP in the management VLAN.

Following is the page of **Management VLAN**.

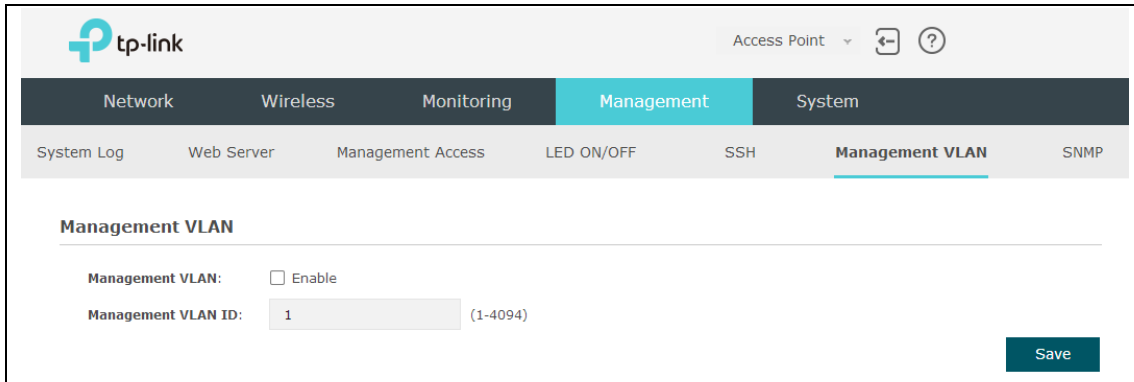

Figure 7-10 Management VLAN Page

Management VLAN: Enable Management VLAN.

Management VLAN ID: Specify the Management VLAN ID. The valid values are from 1 to 4094.

7.7 SNMP

The device can be configured as an SNMP agent.

SNMP (Simple Network Management Protocol), the most widely applied network management protocol, provides a management framework to monitor and maintain Internet devices. Main functions of SNMP include monitoring network performance, detecting and analyzing network error, configuring network devices, and so on. When networks function properly, SNMP can perform the functions of statistics, configuration and testing. When networks have troubles, SNMP can detect and restore these troubles.

An SNMP consists of three key components: manager, agent and MIB (Management Information Base). SNMP manager is a client program operating at workstation, assisting network administrators to accomplish most network device management tasks. An agent is a network-management software module that resides on a managed device and responsible for receiving and dealing with data sent by managing device. Generally the managed devices are network devices including hosts, bridges, switches and routers. MIB is the collection of managed devices. It defines a series of properties of the managed devices. Every SNMP agent has its own MIB.

Once the device has become an SNMP agent, it is able to receive and process request messages from SNMP manager.

Following is the page of **SNMP**.

Figure 7-11 SNMP Page

SNMP Agent: Enable SNMP Agent and the SNMP Agent will collect the information of this device and respond to information requests from one or more management systems.

SysContact: Enter the textual identification of the contact person for this managed node.

SysName: Enter an administratively-assigned name for this managed node.

SysLocation: Enter the physical location of this managed node.

Get Community: Community refers to a host group aiming at network management. Get Community only has the read-only right of the device's SNMP information. The community name can be considered a group password. The default setting is public.

Get Source: Defines the IP address (for example, 10.10.10.1) or subnet for management systems that can serve as Get Community to read the SNMP information of this device. The format of subnet is "IP address/bit" (such as 10.10.10.0/24). The default is 0.0.0.0, which means all hosts can read the SNMP information of this device.

Set Community: Set Community has the read and write right of the device's SNMP information. Enter the community name that allows read/write access to the device's SNMP information. The community name can be considered a group password. The default setting is private.

Set Source: Defines the IP address (for example, 10.10.10.1) or subnet for management systems that can serve as Set Community to read and write the SNMP information of this device. The format of subnet is "IP address/bit" (such as 10.10.10.0/24). The default is 0.0.0.0, which means all hosts can read and write the SNMP information of this device.

NOTE:

Defining community can allow management systems in the same community to communicate with the SNMP Agent. The community name can be seen as the shared password of the network hosts group. Thus, for the security, we suggest modifying the default community name before enabling the SNMP Agent service. If the field of community is blank, the SNMP Agent will not respond to any community name.

Chapter 8 System

System page is mainly used to configure some basic information like user account and time, and realize functions including reboot, reset, backup, restore and upgrade the device.

8.1 User Account

You can change the username and password to protect your device from unauthorized login. We recommend that you change the default user password on the very first system setup.

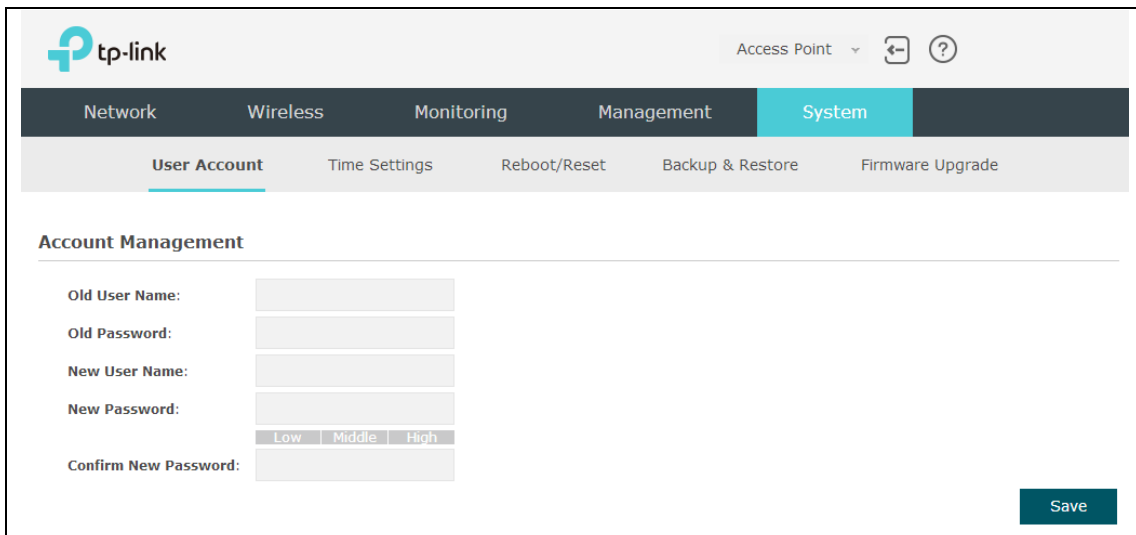

Figure 8-1 User Account Page

Old User Name/Password:	Enter the present user name and password of the admin account to get the permission of modification.
New User Name/Password:	Enter a new user name and password for the admin account. Both values are case-sensitive, up to 64 characters and with no space. New Password must not be "admin"
Confirm New Password:	Enter the new password again.

8.2 Time Settings

System time represents the device system's notion of the passing of time. System time is the standard time for Scheduler and other time-based functions. You can manually set the system time, configure the system to acquire its time settings from a preconfigured NTP server or synchronize the system time with the PC's clock.

The device supports DST (Daylight Saving Time).

The screenshot shows the TP-Link web interface. At the top, there is a navigation bar with tabs for Network, Wireless, Monitoring, Management, and System (which is highlighted). Below this is a sub-navigation bar with options: User Account, Time Settings (highlighted), Reboot/Reset, Backup & Restore, and Firmware Upgrade. The main content area is titled "Time Settings" and contains the following fields and buttons:

- Time zone:** A dropdown menu showing "(GMT+08:00) Beijing, Hong Kong, Perth, Singapore".
- Date:** A text input field containing "01/01/2014" with "MM/DD/YYYY" as a placeholder.
- Time:** Three dropdown menus for hours, minutes, and seconds, showing "19", "03", and "37" respectively, with "(HH/MM/SS)" as a placeholder.
- Primary NTP Server:** A text input field with "(optional)" as a placeholder.
- Secondary NTP Server:** A text input field with "(optional)" as a placeholder.
- Buttons:** "Get GMT" and "Synchronize PC's Clock" are located below the NTP server fields. A "Save" button is located at the bottom right of the section.

Below the "Time Settings" section is the "Daylight Saving" section, which includes:

- Daylight Saving:** A checkbox labeled "Enable" which is currently unchecked.
- Mode:** Three radio buttons: "Predefined Mode" (selected), "Recurring Mode", and "Date Mode".
- Predefine Country:** A dropdown menu showing "European".
- Buttons:** A "Save" button is located at the bottom right of this section.

Figure 8-2 Time Settings

8.2.1 Time Settings

This is a detailed view of the "Time Settings" section from the previous screenshot. It shows the following elements:

- Time zone:** A dropdown menu with the selected value "(GMT+08:00) Beijing, Hong Kong, Perth, Singapore".
- Date:** A text input field with "01/01/2014" and "MM/DD/YYYY" as a placeholder.
- Time:** Three dropdown menus for hours, minutes, and seconds, with values "19", "03", and "37" and "(HH/MM/SS)" as a placeholder.
- Primary NTP Server:** A text input field with "(optional)" as a placeholder.
- Secondary NTP Server:** A text input field with "(optional)" as a placeholder.
- Buttons:** "Get GMT" and "Synchronize PC's Clock" are located below the NTP server fields. A "Save" button is located at the bottom right.

Figure 8-3 Time Settings

- | | |
|-------------------|---|
| | Click the button and the device will obtain GMT time from NTP server. IP address of the NTP server has to be filled in. |
| | Click the button and save the configuration, your PC's time will be obtained as the device's system time. |
| Time zone: | Select your local time zone from the drop-down list. |

Date: Set the current date, in format MM/DD/YYYY. For example, for November 25, 2014, enter 11/25/2014 in the field.

Time: Specify the device's time. Select the number from the drop-down list in time format HH/MM/SS.

Primary/Secondary NTP Server: If you've selected **Get GMT** from an NTP server, please input the primary NTP server address and an alternative NTP server address.

8.2.2 Daylight Saving

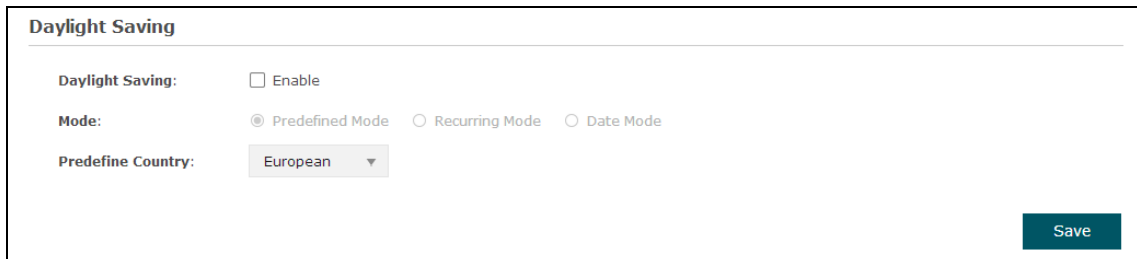

The screenshot shows a configuration panel titled "Daylight Saving". It contains three main sections: "Daylight Saving:" with an "Enable" checkbox; "Mode:" with three radio button options: "Predefined Mode" (selected), "Recurring Mode", and "Date Mode"; and "Predefine Country:" with a dropdown menu showing "European". A "Save" button is positioned at the bottom right of the panel.

Figure 8-4 Daylight Saving

Daylight Saving: Enable or disable the DST. DST is disabled by default.

Mode: Options include [Predefined Mode](#), [Recurring Mode](#) and [Date Mode](#). Please refer to the following content for more information.

• Predefined Mode

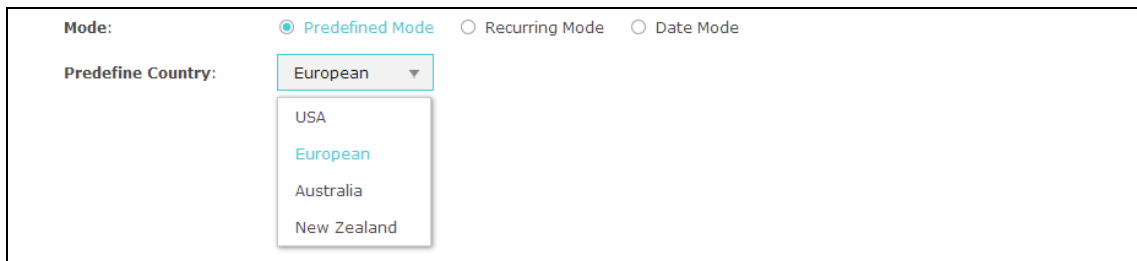

The screenshot shows the "Predefined Mode" configuration. The "Mode:" section has "Predefined Mode" selected. The "Predefine Country:" dropdown menu is open, displaying a list of options: "USA", "European" (highlighted in blue), "Australia", and "New Zealand".

Figure 8-5 Predefined Mode

Mode: Select **Predefined Mode**.

Predefine Country: Select a predefined DST configuration. Europe is the predefined country by default.

- **USA:** Second Sunday in March, 02:00 ~ First Sunday in November, 02:00
- **European:** Last Sunday in March, 01:00 ~ Last Sunday in October, 01:00
- **Australia:** First Sunday in October, 02:00 ~ First Sunday in April, 03:00

- **New Zealand:** Last Sunday in September, 02:00 ~ First Sunday in April, 03:00

• Recurring Mode

Mode: Predefined Mode Recurring Mode Date Mode

Time Offset: minutes(1-180)

Start: Last ▾ Sun ▾ in Mar ▾ at 01 ▾ : 00 ▾

End: Last ▾ Sun ▾ in Oct ▾ at 01 ▾ : 00 ▾

Figure 8-6 Recurring Mode

- Mode:** Select **Recurring Mode**. The configuration is recurring in use.
- Time Offset:** Specify the time adding in minutes when Daylight Saving Time comes.
- Start/End:** Select starting time and ending time of Daylight Saving Time.

• Date Mode

Mode: Predefined Mode Recurring Mode Date Mode

Time Offset: minutes(1-180)

Start: 2014 ▾ - Mar ▾ - 01 ▾ at 01 ▾ : 00 ▾

End: 2014 ▾ - Oct ▾ - 01 ▾ at 01 ▾ : 00 ▾

Figure 8-7 Date Mode

- Mode:** Select **Date Mode**.
- Time Offset:** Specify the time adding in minutes when Daylight Saving Time comes.
- Start/End:** Select starting time and ending time of Daylight Saving Time.

8.3 Reboot/Reset

tp-link Access Point ▾ ↶ ?

Network Wireless Monitoring Management **System**

User Account Time Settings **Reboot/Reset** Backup & Restore Firmware Upgrade

Reboot & Reset

Reboot Device:

Reset to Factory Default:

Figure 8-8 Reboot & Reset

Click **Reboot** to restart the device. Click **Reset** to restore the device to factory default settings.

8.4 Backup & Restore

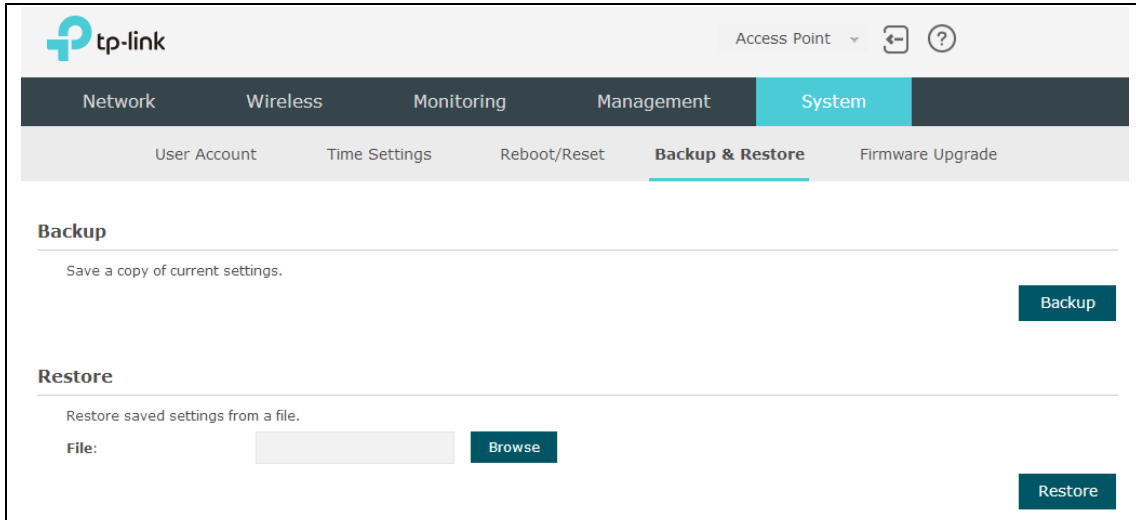

Figure 8-9 Backup & Restore

You can save the current configuration of the EAP as a backup file and restore the configuration via a backup file. To prevent the settings from being lost, we recommend that you back up the settings before you upgrade the device or upload a new configuration file. Restore function helps you to restore the device to previous settings by uploading a backup file.

8.5 Firmware Upgrade

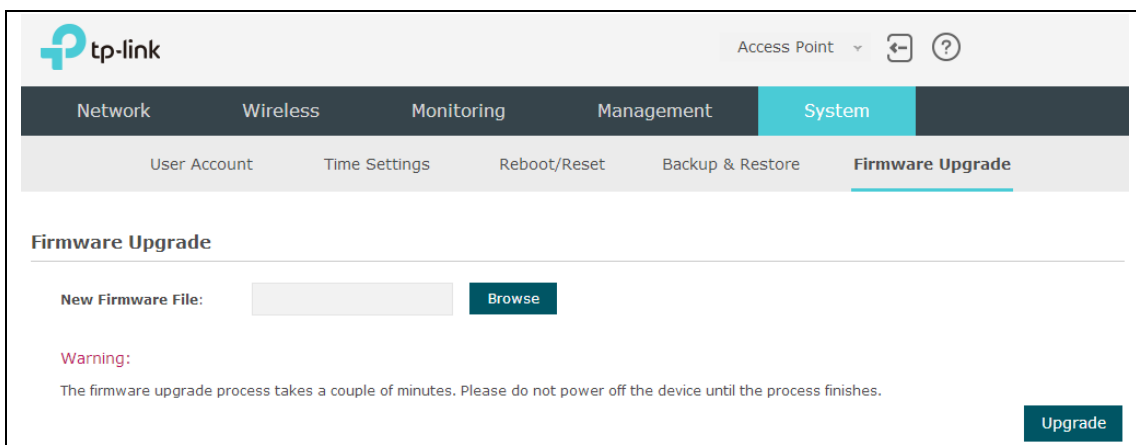

Figure 8-10 Firmware Upgrade

Please log in <http://www.tp-link.com/> to download the latest system file. Click **Browse** to choose the firmware file. Click **Upgrade** to upgrade the devices.

NOTE:

1. Please select the proper software version that matches your hardware to upgrade.
2. To avoid damage, please do not turn off the device while upgrading.
3. After upgrading, the device will reboot automatically.