

USER MANUAL

ACX300-R2

CATX DVI + USB KVM EXTENDER EC

24/7 TECHNICAL SUPPORT AT 1.877.877.2269 OR VISIT BLACKBOX.COM

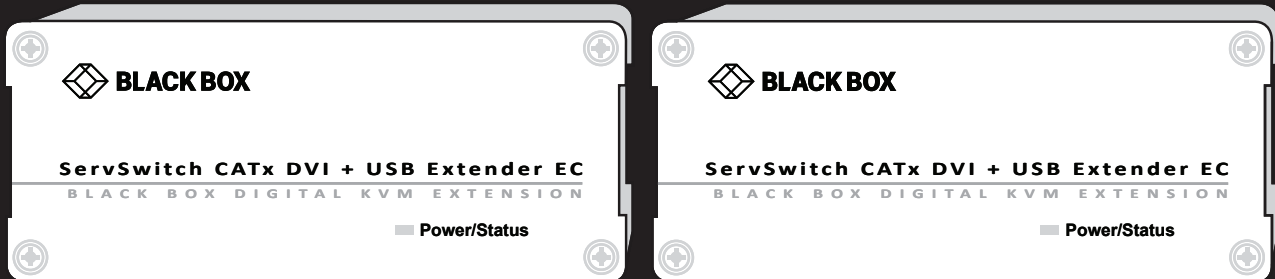

TABLE OF CONTENTS

SAFETY INSTRUCTIONS	4
1. SPECIFICATIONS.....	5
2. OVERVIEW.....	6
2.1 Introduction.....	6
2.2 Intended Use.....	6
2.3 What's Included.....	6
2.4 Hardware Description.....	6
2.4.1 Local Extender.....	6
2.4.2 Remote Extender.....	8
2.4.3 LED Indicators.....	9
3. INSTALLATION	10
3.1 Mounting Options.....	10
3.1.1 Mounting Pads and Rubber Feet.....	10
3.1.2 Mounting Kits (Optional).....	10
3.2 Installing the Extender.....	10
3.3 Startup.....	12
3.4 Removing a CATx Cable.....	12
4. EXTENDER MENU/SETTINGS	13
4.1 Access the Main Menu.....	13
4.2 Status Menu.....	13
4.3 Determine the Current Firmware Version.....	14
4.4 Perform a Firmware Upgrade.....	14
4.5 Unlock an Option.....	14
4.6 Enable or Disable the USB Menu Option.....	16
4.7 Define What DDC Information is Used by the PC.....	17
4.8 Change the Network Settings.....	17
4.9 Change the Extender Settings.....	18
4.9.1 Enable or Disable the USB Compatibility Mode.....	19
4.9.2 Show the Last Received Image.....	20
4.9.3 Turn ON or OFF Monitor Synchronization.....	21
4.9.4 Lock the Main Menu.....	21
4.9.5 Use the Power Saving Mode.....	22
4.9.6 Select Your Type of Keyboard.....	23
4.9.7 Change the Keyboard Fallback Mode.....	23
4.9.8 Change Keyboard Shortcuts.....	24
4.9.9 Close the Extender Settings Menu.....	25
4.10 Switch Between Different Computers.....	25
4.11 Share Videos.....	25



TABLE OF CONTENTS

5. NETWORK SETTINGS	27
5.1 Access the Network Settings Menu (Master View and Network Mode)	27
5.2 Force Disconnect or Select a Workstation from the Current Connected Devices	28
5.3 Manage User Details, Rights and Groups	30
5.4 View the Status of All Remote Units	32
5.5 View the Status of All Local Units	33
5.6 Set Up Dual-Head or Multi-Head Systems	34
5.7 Enable User Groups and Rights and Login Access	36
5.8 Auto-Connect to a Free Computer After an Interruption	37
5.9 Set Up a Private Connection	38
5.10 Enable the User PC Binding Mode	38
5.11 Enable the Disconnect on PC Power Down Option	39
5.12 Hide Info Display	39
5.13 Reconnect on Startup	40
5.14 Video Sharing	40
5.15 Set the Password Timeout	41
6. MAINTENANCE AND CARE	42
7. TROUBLESHOOTING	43
8. DISPOSAL	44
9. TECHNICAL SUPPORT	45
9.1 Contacting Black Box Technical Support	45
9.2 Shipping and Packaging	45
APPENDIX A. REQUIREMENTS FOR CAT5/6/7 CABLES	46
APPENDIX B. REQUIREMENTS FOR A NETWORK SWITCH	47
APPENDIX C. REGULATORY INFORMATION	48
C.1 FCC Information	48
C.2 NOM Statement	49
APPENDIX D. DISCLAIMER/TRADEMARKS	50
D.1 Disclaimer	50
D.2 Trademarks Used in this Manual	50



SAFETY INSTRUCTIONS

WARNING! Read and understand all safety instructions.

- ♦ Follow all the instructions. This will avoid accidents, fire, explosions, electric shocks or other hazards that may result in damage to property and/or severe or fatal injuries. Please ensure that everyone who uses the product has read and followed these warnings and instructions.
- ♦ Keep all safety information and instructions for future reference and pass them on to subsequent users of the product.
- ♦ The manufacturer is not liable for cases of material damage or personal injury caused by incorrect handling or non-compliance with the safety instructions. In such cases, the warranty will be voided.
- ♦ This product is not intended for use by persons (including children) with restricted physical, sensory or intellectual capability or lack of experience and/or knowledge, unless they are supervised by a person who is responsible for their safety or provides them with instructions on how to use the product.

DANGER! Not for use in potentially explosive environments.

DANGER! Be vigilant at all times, and always take care around this product. Do not use electrical equipment if you are lacking in concentration or awareness, or are under the influence of drugs, alcohol or medication. Even a moment of inattentiveness can lead to serious accidents and injuries when using electrical equipment. Check the product and the cables for any damage before use. If there is any visible damage, a strong odor, or excessive overheating of components unplug all the connections immediately and stop using the product.

- ♦ If the product is not installed and used in accordance with this manual, it may cause disruptive interference with radio or television reception or affect other electronic products in residential areas.
- ♦ Use shielded cables only to connect the components in order to avoid such interference. Non-compliance invalidates the permission to operate this product.
- ♦ Only the adapter included with the product should be used as the power supply. Do not use other adapters.
- ♦ Prior to connecting to the power, make sure your local voltage matches the rating indicated on the product.
- ♦ The product must be connected to a permanent and grounded AC wall socket.
- ♦ Protect cables from being strained, pinched or buckled and place them in a way to prevent people from tripping over the cord.

In particular, ensure to avoid damage to the main power adapter:

- ♦ Use the product with a suitable, properly installed and easily accessible main power socket. Make sure the product can be disconnected from the power socket at all times.
- ♦ Unplug the product during electrical storms or when not in use.

DANGER! Never touch the adapter with wet hands.

- ♦ Use the product within the specified performance limits.
- ♦ Keep the product away from flammable materials such as curtains and drapes.
- ♦ Protect the main power adapter from use by third parties (particularly children). Keep the unused main power adapter in a dry, elevated or locked location away from children.
- ♦ Do not place the product near heaters.
- ♦ Do not drop or hit the product.
- ♦ Unplug all connections before cleaning the product. Do not use wipes or chemicals as these could damage the surface. Wipe the housing with a damp cloth. Electrical/ electronic parts must not be cleaned.
- ♦ Alterations to the product and technical modifications are not permitted.



CHAPTER 1: SPECIFICATIONS

TABLE 1-1. SPECIFICATIONS

SPECIFICATION	DESCRIPTION
Approvals	CE, FCC, RoHS2
Connectors	Local Extender: (1) DVI for Monitor Out, (1) DVI for PC In, (1) USB Type B connector for PC, (1) RJ-45 socket for CAT5/6/7 interconnect cable, (1) barrel connector for DC power; Remote Extender: (1) DVI connector for Monitor Out, (4) USB Type A connectors for keyboard, mouse and other Human Interface Devices (HIDs), (1) RJ-45 socket for CAT5/6/7 interconnect cable, (1) barrel connector for DC power
Indicators	Each unit: (1) Power LED
Power	Input: 100 to 240 VAC, 50/60 Hz; Output: Each unit: (1) 12-VDC, 1-A power supply; Per unit: 5 W (excluding attached USB devices)
Enclosure	Anodized aluminum
Environmental	Temperature Tolerance: Operating: 32 to 140° F (0 to 60° C), Storage: -13 to +140 F (-25 to +60° C); Humidity Tolerance: Operating: Max. 80%, noncondensing, Storage: Max. 80%, noncondensing
MTBF	82,820 hours (9.5 years)
Dimensions	Each unit: 1.6"H x 4.2"W x 3.9"D (4.1 x 10.6 x 9.8 cm)
Weight	Per Local and Remote Extender Set: 1.2 lb. (0.54 kg)

CHAPTER 2: OVERVIEW

2.1 OVERVIEW

The ACX300-R2 KVM Extender increases the distance that a keyboard, monitor and mouse can be placed from a computer. This product is intended for professional use. The product should not be used in potentially explosive environments.

2.2 INTENDED USE

The extender may only be used according to the instructions as described in this manual. All use, other than that described in this manual, is seen as unintended use. Modifications in the course of technological progress are reserved. In these user instructions the ACX300-R2 KVM Extender is referred to as an extender. The Local Extender is referred to as the local unit and the Remote Extender is referred to as the remote unit.

2.3 WHAT'S INCLUDED

Your package should contain the following items. If anything is missing or damaged, contact Black Box Technical Support at 877-877-2269 or info@blackbox.com

- (1) Transmitter
- (1) HDMI to DVI-D cable
- (1) USB Type A to B cable
- (1) 12-VDC Power Supply w/ US, UK, EU and AU power clips
- (1) pack of 4 rubber feet
- (1) pack of self adhesive velcro strips
- (1) Receiver
- (1) 12-VDC Power Supply w/ US, UK, EU and AU power clip
- (1) pack of 4 rubber feet
- (1) pack of self adhesive velcro strips

2.4 HARDWARE DESCRIPTION

2.4.1 LOCAL EXTENDER

Figures 2-1 and 2-2 show the front and back panels of the Local Extender. Table 2-1 describes its components.

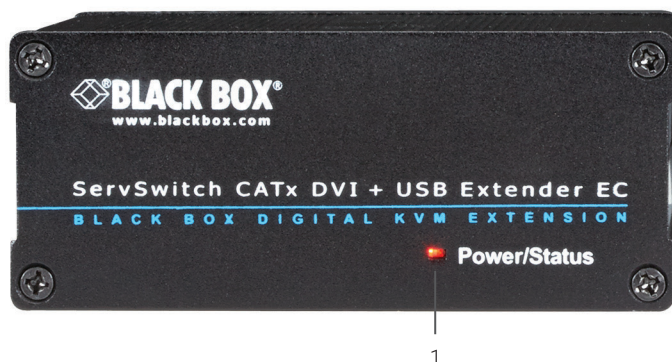

FIGURE 2-1. FRONT PANEL OF THE LOCAL EXTENDER

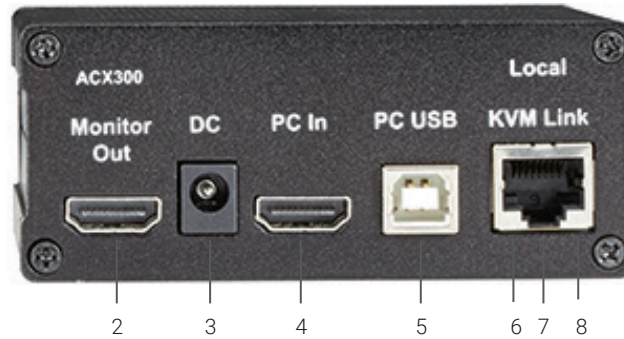

FIGURE 2-2. BACK PANEL OF THE LOCAL EXTENDER

TABLE 2-1. LOCAL EXTENDER COMPONENTS

NUMBER IN FIGURES 2-1 AND 2-2	COMPONENT	DESCRIPTION
1	(1) Power/Status LED	Displays the status of the extender (See Table 2-3)
2	(1) DVI monitor OUT	Connects to monitor
3	(1) barrel connector for DC power	Connects to 12-VDC power supply
4	(1) DVI connector	Connects to PC
5	(1) USB Type B connector for PC IN.	Connects to PC USB
6	(1) Link/Activity LED on RJ-45 connector	See Table 2-3
7	(1) RJ-45 connector	Links to CAT5/6/7 interconnect cable
8	(1) Speed LED on RJ-45 connector	See Table 2-3

CHAPTER 2: OVERVIEW

2.4.2 REMOTE EXTENDER

Figures 2-3 and 2-4 show the front and back panels of the Remote Extender. Table 2-2 describes its components.



FIGURE 2-3. FRONT PANEL OF THE REMOTE EXTENDER

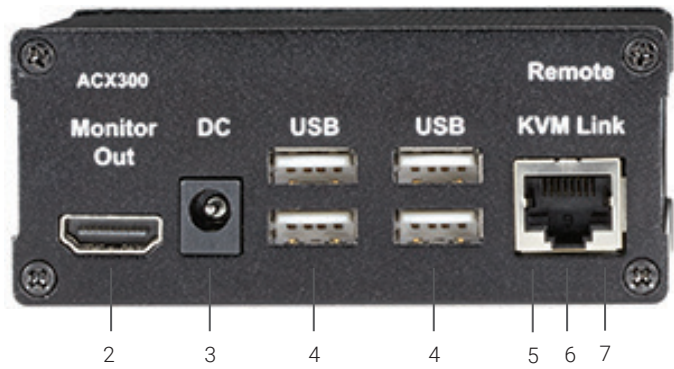

FIGURE 2-4. BACK PANEL OF THE REMOTE EXTENDER

CHAPTER 2: OVERVIEW

TABLE 2-2. REMOTE EXTENDER COMPONENTS

NUMBER IN FIGURES 2-3 AND 2-4	COMPONENT	DESCRIPTION
1	(1) Power/Status LED	Displays the status of the extender (See Table 2-3)
2	(1) DVI monitor OUT	Connects to monitor
3	(1) barrel connector for DC power	Connects to 12-VDC power supply
4	(4) USB Type A connectors	Connects to keyboard, mouse, HIDs
5	(1) Link/Activity LED on RJ-45 connector	See Table 2-3
6	(1) RJ-45 connector	Links to CAT5/6/7 interconnect cable
7	(1) Speed LED on RJ-45 connector	See Table 2-3

2.4.3 LED INDICATORS

Table 2-3 describes the LED indicators on the extenders.

TABLE 2-3. LED INDICATOR FUNCTIONS

COLOR	BLINKING	BLINKING	ACTIVE CONNECTION	VIDEO EXTENDED	USB INITIALIZATION	USB DATA RECEIVED	IDENTIFY COMMAND	AUTO UPDATE MODE
Main LED								
Red	—	Yes	No	No	—	—	—	—
Red	Slow	No	No	No	—	—	—	Update failed
Orange	—	Yes	Yes	No	—	—	—	—
Orange	Fast	—	—	—	—	—	—	Update in progress
Green	—	Yes	Yes	Yes	—	—	—	Update succeeded
Green	V. Fast	—	—	—	Yes*	—	—	—
Red/ Green	V. Fast	—	—	—	—	—	Yes	—
RJ-45 Socket LEDs								
Yellow	—	No	—	—	—	—	—	—
Yellow	Slow	Yes	—	—	—	—	—	—
Green	—	—	—	Yes	—	—	—	—
Green	V. Fast	—	—	—	—	Yes	—	—

*Remote only

CHAPTER 3: INSTALLATION

3.1 MOUNTING OPTIONS

3.1.1 MOUNTING PADS AND RUBBER FEET

The mounting pads and rubber feet can be used to hold the extenders in place and prevents them from sliding and falling.

To attach the mounting pads or rubber feet:

1. Remove the protection layer from the mounting pads or rubber feet.
2. Attach the mounting pads or rubber feet to the bottom the units.

3.1.2 MOUNTING KITS (OPTIONAL)

The following mounting kits are available:

- ◆ Rackmounting kit (part number ACX300-RMK)
- ◆ Under-desk mounting kit (part number ACX300-DMK)
- ◆ DIN rail mounting kit (part number ACX300-DRM)

3.2 INSTALLING THE EXTENDER

WARNING! Read and understand all safety information before installing the product.

The units can be set up to access one host computer, or to access numerous host computers. In the case of the latter, an additional Network Switch must be installed. With a Network Switch, each user can gain quick access to any of the required computers.

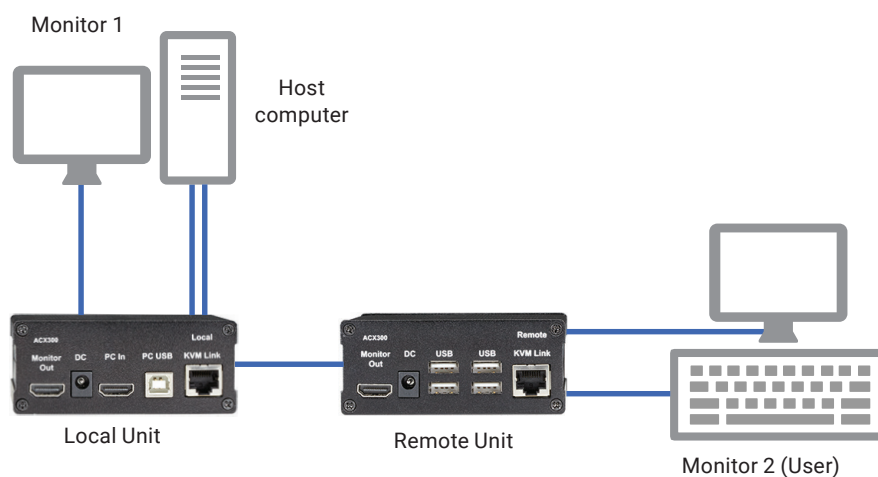

FIGURE 3-1. SINGLE SETUP

CHAPTER 3: INSTALLATION

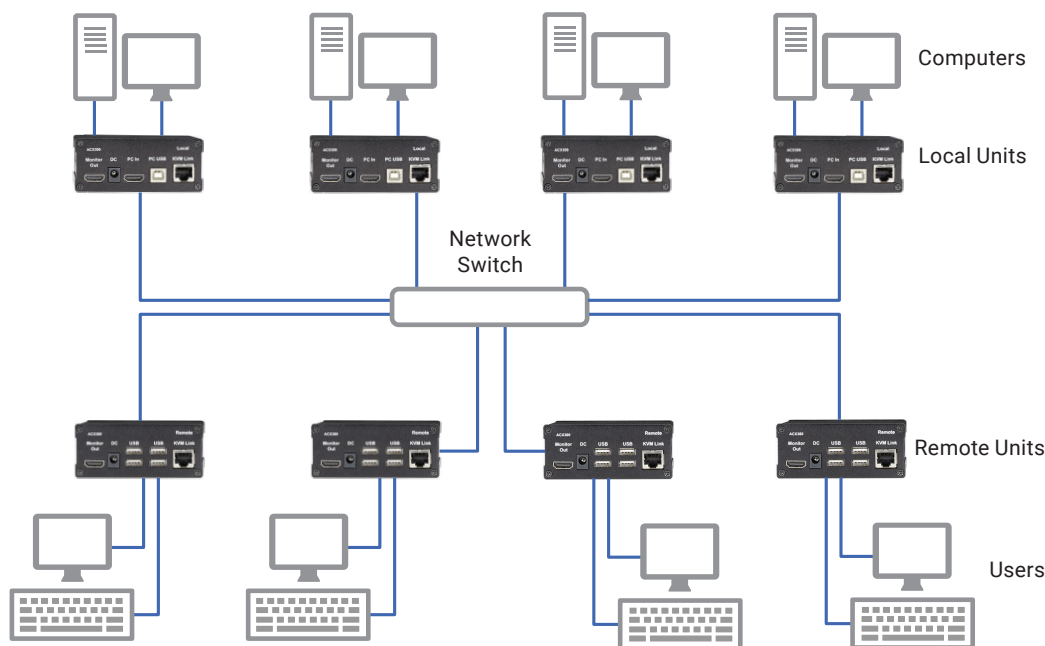

FIGURE 3-2. NETWORK SWITCH SETUP

To install the product with/without a Network Switch:

1. Position the local unit close to the host computer.
2. Position the remote unit at the desired location.
3. If you are using a Network Switch, position the device between the local unit and the remote unit.

NOTE: The maximum distance between the units with CATx cable is 656 feet (200 meters).

4. Connect a monitor to the HDMI-out connector on the local unit.
5. Connect one end of the supplied HDMI-cable to the HDMI-in on the local unit.
6. Connect the other end of the supplied HDMI-cable to the HDMI connection on your computer.
7. Connect one end of the supplied USB cable to the USB connection on the local unit.
8. Connect the other end of the supplied USB cable to a USB port on your computer.
9. Connect a second monitor to the HDMI-out connector on the remote unit.
10. Connect a keyboard to a USB port on the remote unit.
11. Connect a mouse to a USB port on the remote unit.
12. Do one of the following, depending on your model and configuration:

For the extender with Network Switch (see Appendix B):

- ◆ Connect one end of a CATx cable (not included) to the kvm-link port on the local unit. Make sure that the plug is latched.
- ◆ Connect the other end of the CATx cable to one of the two CATx ports on the Network Switch.
- ◆ Connect the end of a second CATx cable (not included) to the kvm-link port on the remote unit. Make sure that the plug is latched.
- ◆ Connect the other end of the second CATx cable to the other CATx port on the Network Switch.

CHAPTER 3: INSTALLATION

For the extender without Network Switch (see Appendix A):

- ♦ Make sure the dust protectors on the Network Switch and Extenders have been removed.
- ♦ Connect one end of the CATx cable (not included) to the kvm-link port on the local unit. Make sure that the plug is latched.
- ♦ Connect the other end of the CATx cable to the kvm-link port on the remote unit. Make sure that the plug is latched.

17. If you are using a Network Switch, connect your other workstations (remote extenders) and computers (local extenders) with the Network Switch (see Appendix B).

18. If you are using a Network Switch, connect the Power supply to the AC connection on the Network Switch.

19. Connect a power supply to the DC connection on the local unit.

20. Connect the other power supply to the DC connection on the remote unit.

3.3 STARTUP

To start up the system without a switch:

1. Make sure that the two monitors and the computer are switched on.
2. If you are using a Network Switch, connect the power supply to a grounded wall socket.
3. Connect both extender power supplies to a grounded wall socket. Both extenders will start an initialization process. The red status LED blinks a few seconds. After a few seconds, the status LED lights green. The monitor will display your computer's desktop or any open applications.

3.4 REMOVING A CATX CABLE

To remove a CATx cable:

- ♦ Press the latch down and slowly pull the cable out.

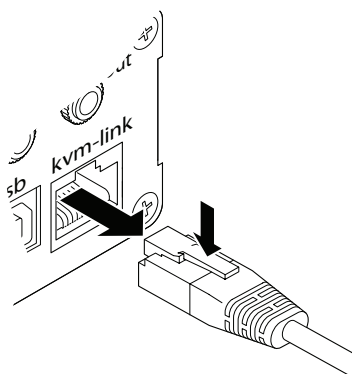

FIGURE 3-3. REMOVING A CATX CABLE

CHAPTER 4: EXTENDER MENU/SETTINGS

4.1 ACCESS THE MAIN MENU

Use the monitor and keyboard to get access to the main menu.

To access the main menu:

1. Make sure the extenders, the monitors and the computer are switched on.
2. Press the Scroll Lock key on your keyboard quickly five times. The main menu appears with an overview of the sub-menus.
3. To access a sub-menu press the applicable key.

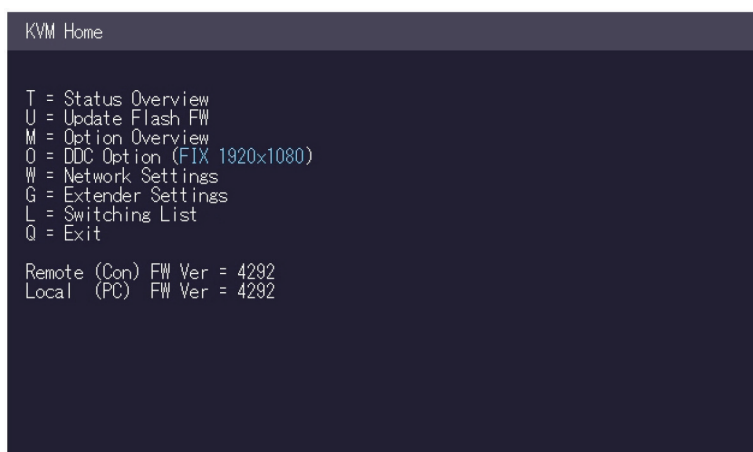

FIGURE 4-1. MAIN MENU

4.2 STATUS MENU

In the Status Menu, the current status of the extender connection is displayed. It provides information on the connection itself as well as resolution of the video channel, and USB status.

- ♦ The enabled options and the current FW version is displayed in the left top corner.
- ♦ Link status shows whether there is a physical connection available. Connection indicates if KVM data is currently able to be transmitted.
- ♦ Video and USB show if data is currently being transmitted.

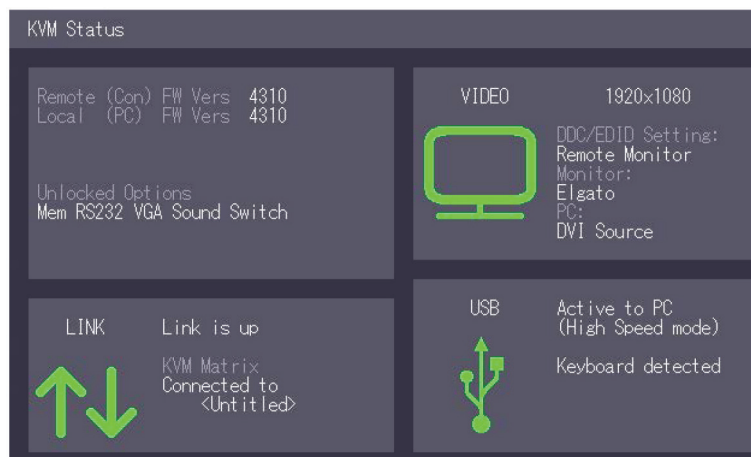

FIGURE 4-2. STATUS MENU

CHAPTER 4: EXTENDER MENU/SETTINGS

4.3 DETERMINE THE CURRENT FIRMWARE VERSION

To view the firmware version:

Make sure the main menu is open. The currently installed firmware versions of the remote and local units are displayed below (e.g., 4267)

```
KVM Home

T = Status Overview
U = Update Flash FW
M = Option Overview
O = DDC Option (FIX 1920x1080)
W = Network Settings
G = Extender Settings
L = Switching List
Q = Exit

Remote (Con) FW Ver = 4292
Local (PC) FW Ver = 4292
```

FIGURE 4-3. CURRENT FIRMWARE VERSION SCREEN

4.4 PERFORM A FIRMWARE UPGRADE

The latest version of the firmware can be downloaded from the BlackBox.com website by typing the part number (ACX300-R2) in the search field and going to the “Resources” tab.

To perform a firmware update:

1. Make sure the main menu is open.
2. Press the U key. The Update menu appears.
 - ◆ Press the N key to do a network update.
 - ◆ Press the A key to do an automatic update.
 - ◆ Press the U key to do a direct update.
 - ◆ Press the Q key to return to the main menu.

4.5 UNLOCK AN OPTION

1. Make sure the main menu is open.
2. Press the M key. The Options Overview menu opens. The device ID will be shown.

CHAPTER 4: EXTENDER MENU/SETTINGS

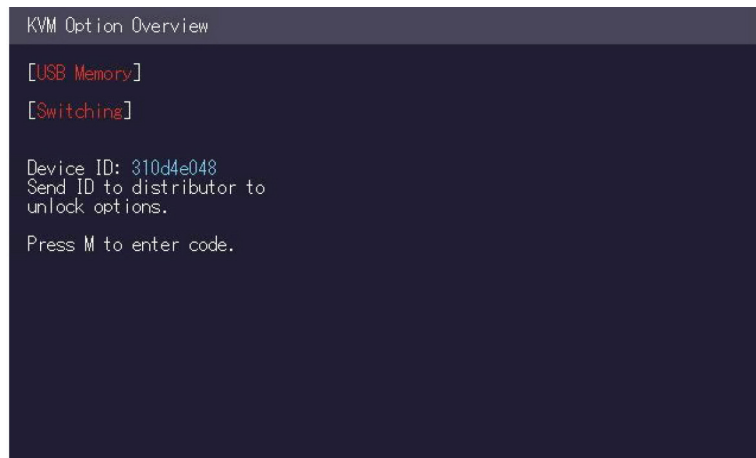

FIGURE 4-4. UNLOCK OPTION SCREEN

3. Contact Black Box Technical Support at 877-877-2269 or info@blackbox.com to get the unlock code from your supplier by providing us with the 9-character device ID and the serial number of your KVM-extender.
4. Press the M key to enter the unlock code.
5. Enter the unlock code from Black Box Technical Support.
6. The extender will automatically restart.
7. To confirm the Option has been unlocked return to the Options Overview menu and check that the relevant Option is now displayed in green.

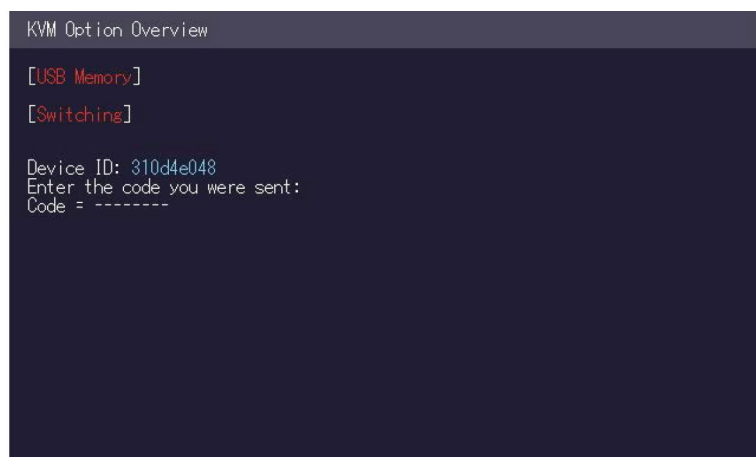

FIGURE 4-5. OPTION SCREEN

CHAPTER 4: EXTENDER MENU/SETTINGS

4.6 ENABLE OR DISABLE THE USB MEMORY OPTION

The USB Memory Option allows the user to enable or disable the memory option. When the USB Memory Option is enabled, USB flash storage and external storage devices can be accessed via the extender. If your extender was provided with the USB Memory Option, you can enable and disable at any time.

To enable or disable the USB Memory Option:

1. Make sure the main menu is open.
2. Press the M key. The Options Overview menu opens. The current USB Memory status is displayed (Enabled or Disabled).
3. Press 1 to enable or 0 to disable the USB Memory Option.

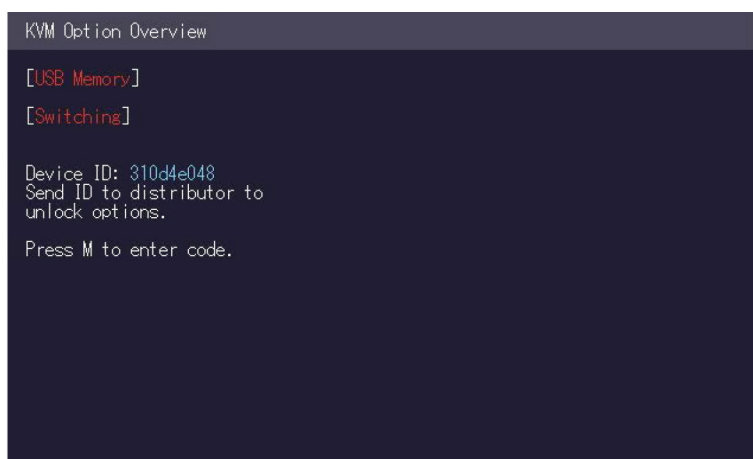

FIGURE 4-6. USB MEMORY OPTION SCREEN

CHAPTER 4: EXTENDER MENU/SETTINGS

4.7 DEFINE WHAT DDC INFORMATION IS USED BY THE PC

The DDC Option menu allows the user to define what DDC information is used by the PC.

To define what DDC information is used by the PC:

1. Make sure the main menu is open.
2. Press the O key. The DDC Option menu appears.
 - ♦ Press 0 to use the DDC information from the monitor attached to the remote extender.
 - ♦ Press 2 to save the current DDC information. The system uses the same settings after the extender has been restarted.
 - ♦ Press 4 through 8 to use a predefined resolution which is saved.
3. Press ESC to go back to the main menu.

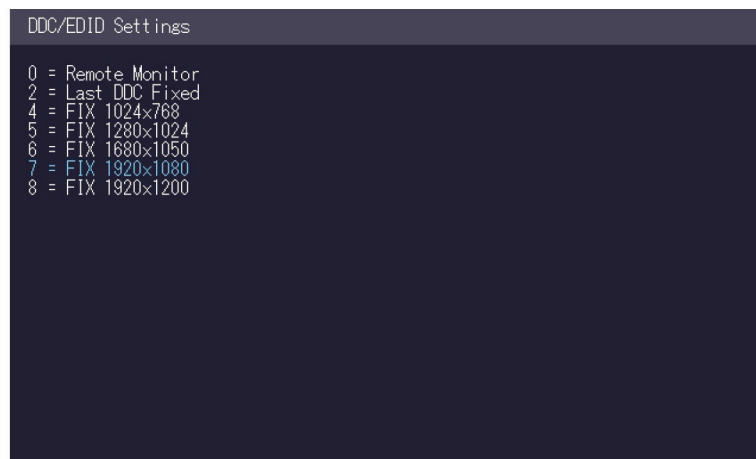

FIGURE 4-7. DDC/EDID SETTINGS SCREEN

4.8 CHANGE THE NETWORK SETTINGS

See Chapter 5, Network Settings.

CHAPTER 4: EXTENDER MENU/SETTINGS

4.9 CHANGE THE EXTENDER SETTINGS

The Extender Settings menu allows the user to change a range of further preferences, which can be enabled or disabled by pressing the applicable key.

To access the Extender Settings menu:

1. Make sure the main menu is open.
2. Press the G key. The Extender Settings menu appears.
3. The extender settings are distributed across two sub-menus: Remote Settings and Local Settings.

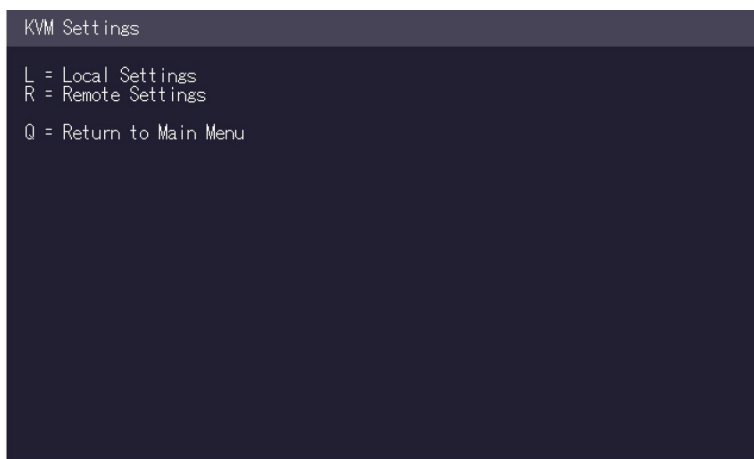

FIGURE 4-8. EXTENDER SETTINGS MENU

4. To access the local or remote extender settings:

- ◆ Press the L key to access the Local Settings menu.

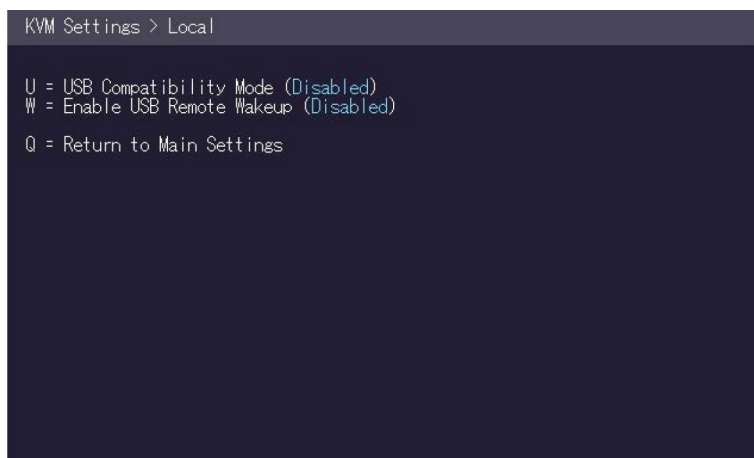

FIGURE 4-9. LOCAL EXTENDER SETTINGS MENU

CHAPTER 4: EXTENDER MENU/SETTINGS

- ◆ Press the R key to access the Remote Settings menu.

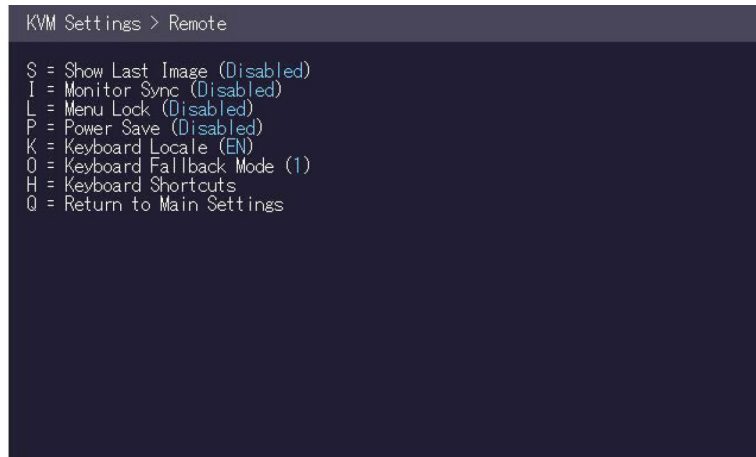

FIGURE 4-10. REMOTE EXTENDER SETTINGS MENU

4.9.1 ENABLE OR DISABLE THE USB COMPATIBILITY MODE

The USB compatibility mode can be enabled or disabled.

To enable/disable the USB compatibility mode:

1. From the Extender Settings menu, press the L key. The Local Settings menu appears.
2. Press the U key to enable or disable the USB compatibility mode.

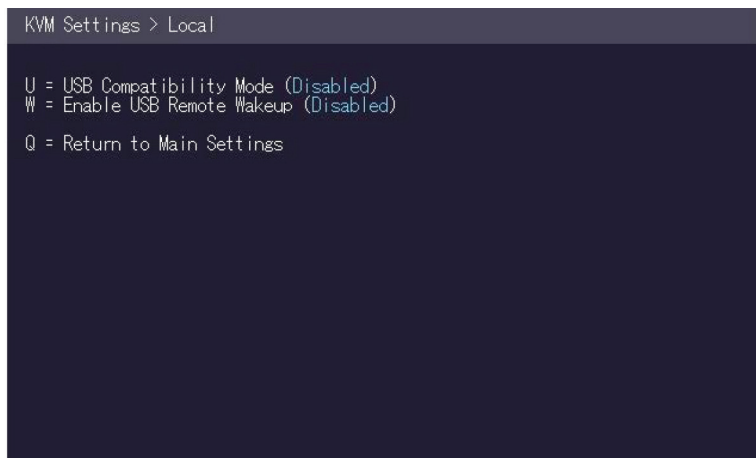

FIGURE 4-11. USB COMPATIBILITY MODE SCREEN

CHAPTER 4: EXTENDER MENU/SETTINGS

4.9.2 SHOW THE LAST RECEIVED IMAGE

This function lets you show the last image that is received instead of a black screen when the monitor extender is disconnected from the PC extender. To show that it is the last image received, the edges of the screen flash red.

To enable or disable the Last Image Received function:

1. From the Extender Settings menu, press the R key. The Remote Settings menu appears.
2. Press the S key to enable or disable the function.
3. Press ESC to go back to the main menu.

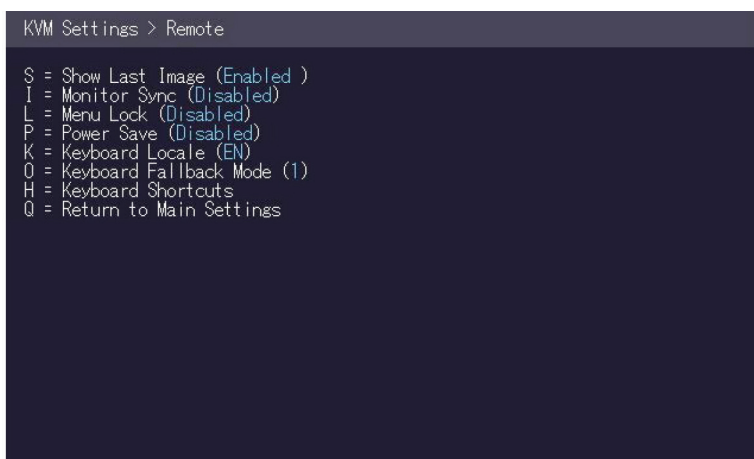

FIGURE 4-12. SHOW LAST RECEIVED IMAGE OPTION

CHAPTER 4: EXTENDER MENU/SETTINGS

4.9.3 TURN ON OR OFF MONITOR SYNCHRONIZATION

The monitor synchronization can be turned on and off. When enabled, the refresh rate of the graphics card of the PC and that of the remote monitor are adjusted to match one another. The advantage of this is to ensure that transmission remains smooth when the screen content changes rapidly (e.g. When using multimedia applications). Not all monitors support this method so by default this option is disabled.

To turn on monitor synchronization:

1. From the Extender Settings menu, press the R key. The Remote Settings menu appears.
2. Press the I key to enable or disable the function.
3. Press ESC to go back to the main menu.

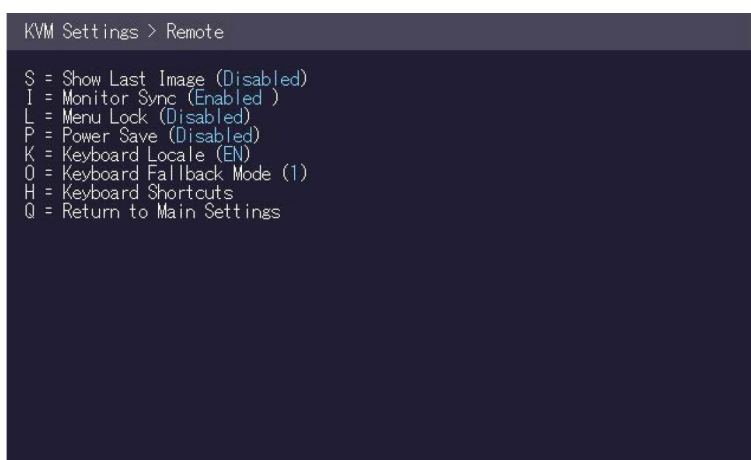

FIGURE 4-13. MONITOR SYNCHRONIZATION OPTION

4.9.4 LOCK THE MAIN MENU

The extender menu can be locked. When enabled, the extender locks 5 minutes after start up to prevent unauthorized access.

To lock or unlock the menu:

1. From the Extender Settings menu, press the R key. The Remote Settings menu appears.
2. Press the L key. The Menu Lock Menu appears.

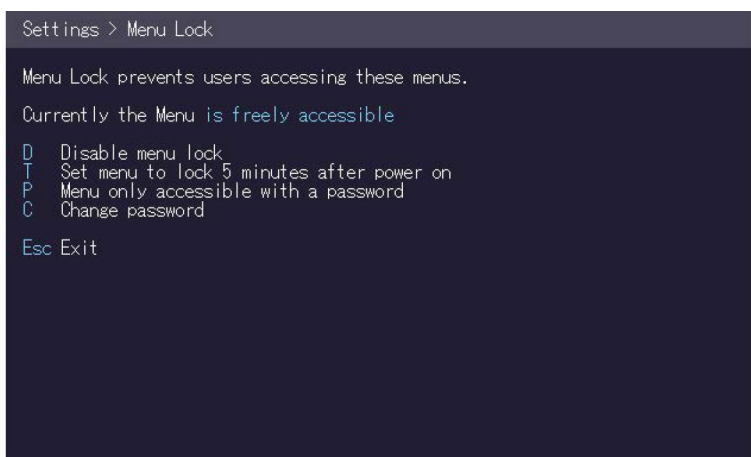

FIGURE 4-14. MENU LOCK OPTION

CHAPTER 4: EXTENDER MENU/SETTINGS

4.9.5 USE THE POWER SAVING MODE

The power saving mode lets the extender turn off its video out when the remote extender does not receive a video signal for more than a minute.

To turn on or off the power saving mode:

1. From the Extender Settings menu, press the R key. The Remote Settings menu appears.
2. Press the P key to enable or disable the power saving mode.
3. When in power saving mode, press any key to return to the menu.

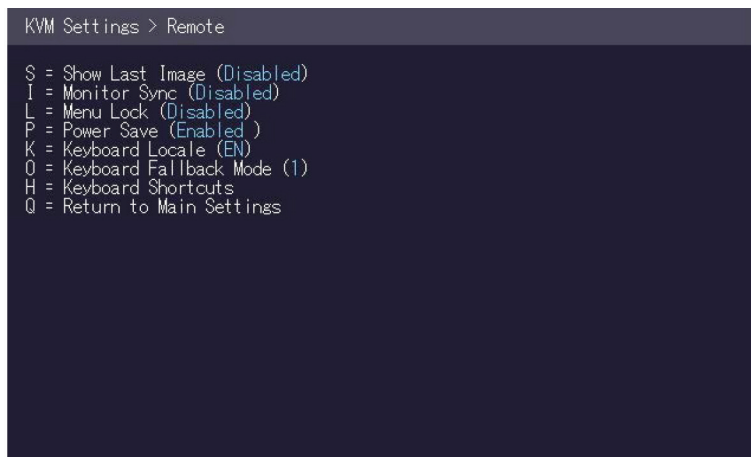

FIGURE 4-15. POWER SAVE MODE OPTION

CHAPTER 4: EXTENDER MENU/SETTINGS

4.9.6 SELECT YOUR TYPE OF KEYBOARD

The Keyboard Locale menu lets you switch between keyboard layouts for navigating the on screen display menu (OSD). You can choose between French (Azerty), English (Qwerty) and German (Qwertz).

To select a keyboard layout:

1. From the Extender Settings menu, press the R key. The Remote Settings menu appears.
2. Press the K key. The Keyboard Locale menu opens:
 - ◆ Press E to select English (QWERTY)
 - ◆ Press D to select German (QWERTZ)
 - ◆ Press F to select French (AZERTY)

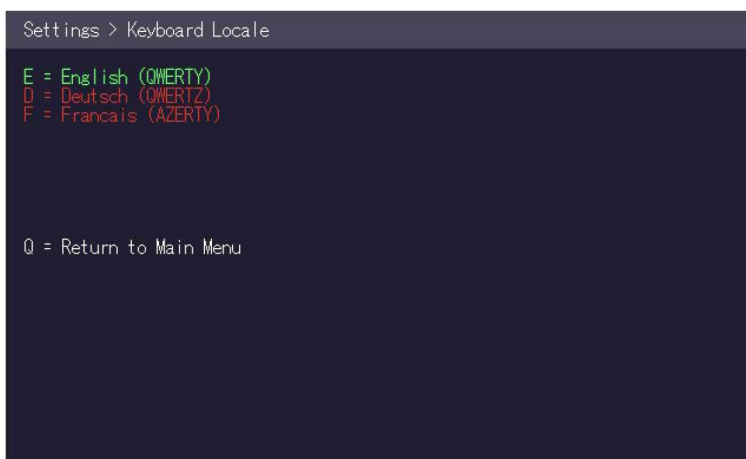

FIGURE 4-16. SELECT KEYBOARD TYPE OPTION

4.9.7 CHANGE THE KEYBOARD FALLBACK MODE

To change the keyboard fallback mode:

1. From the Extender Settings menu, press the R key. The Remote Settings menu appears.
2. Press the O key to change the keyboard fallback mode to 0, 1 or 2.

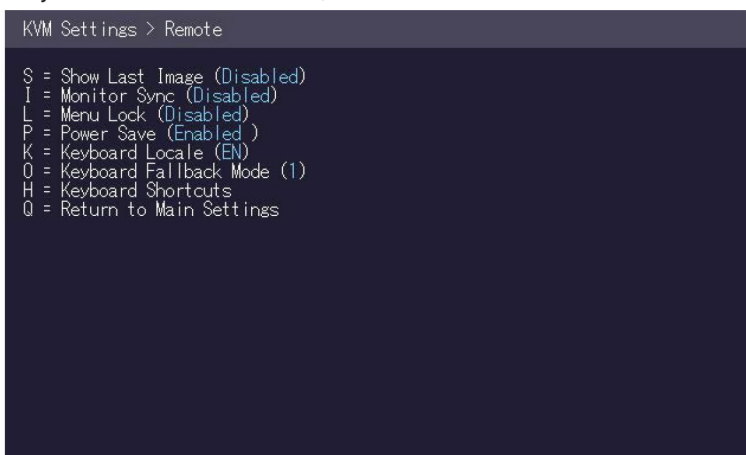

FIGURE 4-17. KEYBOARD FALLBACK MODE OPTION

CHAPTER 4: EXTENDER MENU/SETTINGS

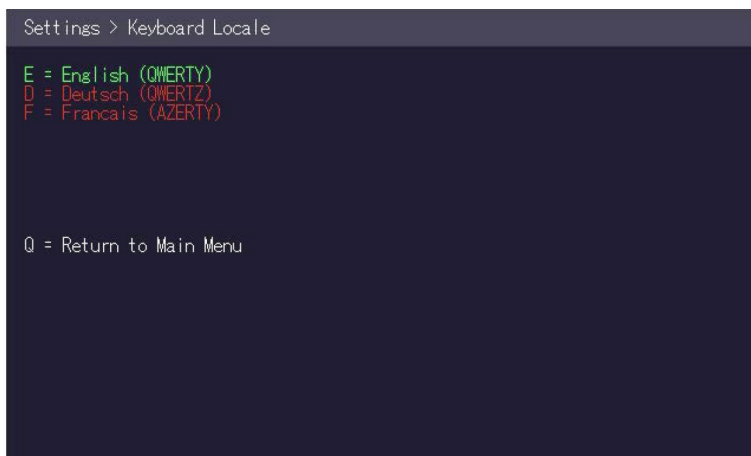

FIGURE 4-18. SELECT KEYBOARD FALLBACK MODE

4.9.8 CHANGE KEYBOARD SHORTCUTS

The Keyboard Shortcuts menu lets you edit the preferred shortcuts for common commands.

To edit the shortcuts:

1. From the Extender Settings menu, press the R key. The Remote Settings menu appears.
2. Press the H key. The Keyboard Shortcuts menu opens.
3. Use the arrows to select a command.
4. Press E to edit the shortcut.

To edit:

- ◆ Press a single key. Edit the frequency with left and right arrows.

- OR -

- ◆ Press a key combination

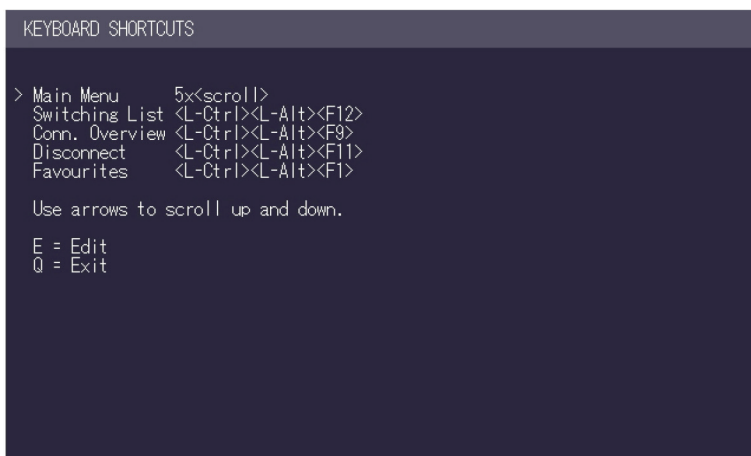

FIGURE 4-19. KEYBOARD SHORTCUTS SCREEN

CHAPTER 4: EXTENDER MENU/SETTINGS

4.9.9 CLOSE THE EXTENDER SETTINGS MENU

To close the Extender Settings menu:

- ◆ Press Q to close the Extender Settings menu.

4.10 SWITCH BETWEEN DIFFERENT COMPUTERS

The menu for switching between different computers is accessible via a USB keyboard connected to the remote unit.

1. Press Ctrl+Alt+F12 (this is the default keyboard shortcut but may be changed. See Section 4.9.8, Change Keyboard Shortcuts). The switching menu opens. The switching menu lists all the local units connected to the switching network.
 - ◆ Blue indicates the computer with which you are currently connected. The status is listed as "conn'd".
 - ◆ White indicates a computer which is currently connected to by another work station (Remote unit). The status is listed as "in use".
 - ◆ Green indicates a computer in the switching network that isn't connected to any work station (Remote unit). The status is listed as "free".
 - ◆ Red indicates a computer that was once in the switching network but isn't currently available. This usually indicates that the Extender has been disconnected from the network. If this is the case, the computer can be removed from the switching menu with the "delete" key.
2. Use the arrow up and arrow down keys, or PGUP and PGDOWN keys, to select a local extender. Press enter. The system switches to the selected computer.
 - ◆ The left column defines the favorites menu and provides each computer with a favorite number. Each favorite number corresponds to a hot-key combination that can be used to quickly connect to the desired computer without having to access the switching menu. For example favorite "1" has the hot-key combination "Ctrl+Alt+F1" For favorite "2" this is "Ctrl+Alt+F2" and so on up to favorite "8" with "Ctrl+Alt+F8". All other computers can still be accessed via the switching menu. To change the order of the computers in this list, select the computer then press a number key 1 through 8 to shift it to that number.
 - ◆ If the password system is active, the user currently logged in is displayed at the bottom. You can manually logout by pressing the "x" key or disconnect from the current PC by pressing the "d" key.

4.11 SHARE VIDEOS

The Video Sharing option allows you to share your screen with other users on the network. Ensure that the switch you are using has IGMP Snooping capabilities, and that this is turned on (most switches have this off by default).

What happens with the control over the local extender depends on the initial state. There are two main use-cases that can both be controlled in the MASTER VIEW connections overview menu.

NOTE: This capability is not available in combination with the password security system.

To share a video:

1. Make sure the main menu is open.
2. Press Ctrl+Alt+F10. The MASTER VIEW connections overview menu opens.
3. Choose one of the following:
 - ◆ To mirror a screen to other consoles:

Press the P key on the keyboard of the extender that should display the user's screen. In this case "P" stands for "push to screen". Such a command is only valid if the console that initiates the mirroring is currently connected to a local unit and has video and the other remote unit is "free" (marked green).

CHAPTER 4: EXTENDER MENU/SETTINGS

- ◆ To see the screen of other consoles on the network:

Press the G key on the keyboard of the extender that should display the user's screen. The key "G" stands for "get screen". If the console unit from which this command is executed currently has a partner, a disconnect is executed before the video of the other local unit is displayed. If the selected local extender currently isn't connected, a regular connection including USB, etc. is established.

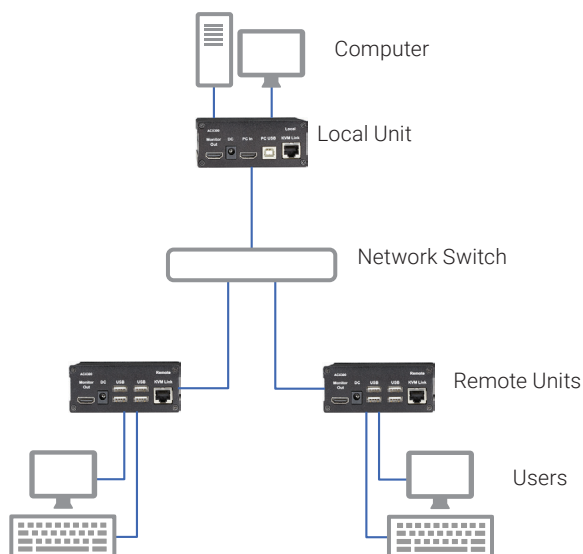

FIGURE 4-20. VIDEO SHARING SETUP

CHAPTER 5: NETWORK SETTINGS

5.1 ACCESS THE NETWORK SETTINGS MENU (MASTER VIEW AND NETWORK MODE)

The Network Settings menu includes the preferences and settings for the Switching Option.

NOTE: This menu is only available when the Switching Option has been unlocked (see Section 4.5, Unlock an Option).

To access the Network Settings menu (Master View and Network Mode):

1. Make sure the main menu is open (see Section 4.1, Access the Main Menu)
2. Press the W key. The Enter User/Password window opens.

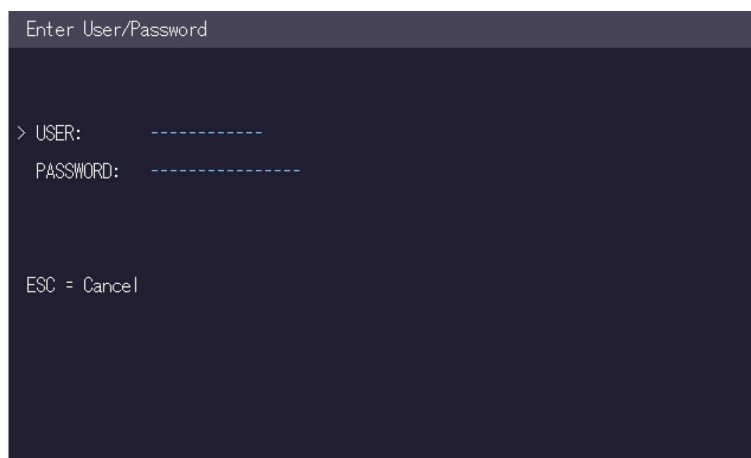

FIGURE 5-1. ENTER USER/PASSWORD WINDOW

3. Log in with your user name and password. The Network Setting menu opens.

NTOE: To prevent unauthorized access to the Network Settings, this option is protected by a user/password combination. Access is only allowed for users with administrator rights. The factory settings provide an administrator user with User: admin and Password: admin.

- ♦ The Master View option allows the administrator to view, add, edit or remove user, console and computer information. Press the V key to access the Master View menu.
- ♦ The Network Mode allows you to define how you want the network system to operate. Each of the modes available may individually be activated or deactivated by pressing the appropriate key. You may have more than one selected depending on their function. Some modes require others, and others are incompatible with each other, but the system will automatically recognize this for you. Press the M key to access the Network Mode menu.

CHAPTER 5: NETWORK SETTINGS

```
NETWORK SETTINGS
V = Master View (Device Configuration)
M = Network Mode
T = Set Timeout ( Immediately)

Q = Save and Exit
```

FIGURE 5-2. NETWORK SETTINGS SCREEN

5.2 ACCESS THE NETWORK SETTINGS MENU (MASTER VIEW AND NETWORK MODE)

The Connection Overview provides an overview of the current connections as well as the free PCs and consoles on the network. You may break a connection remotely, or assign a PC a new console or vice versa.

To force disconnect or select a workstation from the current connected devices:

1. Make sure the Master View menu is open (see Section 5.1, Access the Network Settings Menu [Master View and Network Mode]).

```
MASTER VIEW
O = Connections Overview
U = User List
C = Console Extender List
P = PC Extender List
M = Multi-Head Configuration

R = Restart All Extenders

Q = Exit
```

FIGURE 5-3. MASTER VIEW OPTION

2. Press the O key. The Connection Overview menu opens.

CHAPTER 5: NETWORK SETTINGS

```
MASTER VIEW > connections overview
PCs          Consoles
-----
> <Untitled> ---> <Untitled>

Ctrl+H - Help
```

FIGURE 5-4. CONNECTION OVERVIEW SCREEN

3. Press the I key. The Connection Details window opens.

- ◆ Press the D key to force disconnect the selected device/connection.
- ◆ Press the E key or Enter key to select a PC or workstation to create or break a connection to that unit.
- ◆ Press the Q key to exit.

```
MASTER VIEW > connections detail
> PC:          <Untitled>
  Console:     <Untitled>
  User:        <None>

D = Force Disconnect
E = Select PC for console
Q = Exit
```

FIGURE 5-5. CONNECTION DETAILS SCREEN

CHAPTER 5: NETWORK SETTINGS

5.3 MANAGE USER DETAILS, RIGHTS AND GROUPS

The Console Extender List allows you to manage user details, rights and groups.

To manage user details, rights and groups:

1. Make sure the Master View menu is open (see Section 5.1, Access the Network Settings Menu [Master View and Network Mode]).

```
MASTER VIEW
O = Connections Overview
U = User List
C = Console Extender List
P = PC Extender List
M = Multi-Head Configuration

R = Restart All Extenders

Q = Exit
```

FIGURE 5-6. MASTER VIEW MENU

2. Press the U key. The User List menu opens.

- Press the A key to add a new user.
- Press the R key to delete the selected user.
- Press the I key to display details about the selected user that may be edited.

```
MASTER VIEW > user list
```

USER	GROUPS	RIGHTS
> admin	1	admin

```
A = Add      R = Remove
I = Info     Q = Exit
```

FIGURE 5-7. DETAILS ABOUT SELECTED USER

CHAPTER 5: NETWORK SETTINGS

3. To edit a user, press the I key. The User Detail menu opens.

```
MASTER VIEW > user detail

> USER:      admin
FULL_NAME:  admin
PASSWORD:   *****
RIGHTS:     +++ (admin)
GROUPS:     1
Bound PC:   <None>

E = Edit
Q = Exit
```

FIGURE 5-8. USER DETAIL MENU

4. Select the user detail you want to edit and press the E key.

- ◆ User: Assign each user a login name with max. 12 characters.
- ◆ Full Name: For clarity, the full name of a user may be entered with max. 20 characters. This name is displayed when informing other users who interrupted their connection.
- ◆ Password: Each user requires a password for the login. Max. 16 characters.
- ◆ Rights: There are three types of rights: USER, MASTER and ADMIN. By pressing the + key, the rights of the selected user can be changed. The rights control access to the Network Settings menu (only ADMIN), and which users may interrupt the connection of which other users.
 - Admin: May interrupt connections of Masters and Users. In the case that an Admin interrupts the connection of another Admin, the interrupted Admin may reclaim the original connection. Private connections can't be interrupted.
 - Master: May interrupt connections of Users. In the case that a Master interrupts the connection of another Master, the interrupted Master may reclaim the original connection. Admins and private connections can't be interrupted.
 - User: In the case that a User interrupts the connection of another User, the interrupted User may reclaim the original connection. Admins, Masters and private connections can't be interrupted.
- ◆ Groups: Each user can join up to 8 user groups. Each computer is defined as belonging to one user group. By default all computers are in the same user group. This system makes it possible to allow or deny different users access to a computer. The user's group access is set by pressing the buttons 1 – 8.
- ◆ Bound PC: When in User-PC Binding mode (see 4.10) each user must have a PC bound to them. That user will only be able to connect to that PC. When selected the User Detail menu, press RETURN a list of PCs on the network will be displayed to select from.

CHAPTER 5: NETWORK SETTINGS

5.4 VIEW THE STATUS OF ALL REMOTE UNITS

The Console Extender List allows you to view all remote units in the switching network and their current status.

To view the status of all remote extenders:

1. Make sure the Master View menu is open (see Section 5.1, Access the Network Settings Menu [Master View and Network Mode]).

```
MASTER VIEW
O = Connections Overview
U = User List
C = Console Extender List
P = PC Extender List
M = Multi-Head Configuration

R = Restart All Extenders

Q = Exit
```

FIGURE 5-9. MASTER VIEW MENU

2. Press the C key. The Console Extender List menu opens.

- “this” defines the extender that you are currently using.
- “in use” indicates that the extender is in use.
- “free” indicates that this extender is not busy.

```
MASTER VIEW > console extender list

NAME | STATUS
-----|-----
> <Untitled> | this

R = Remove (Disconnected Only)
I = Info Q = Exit
```

FIGURE 5-10. CONSOLE EXTENDER LIST

3. To edit the name of an extender, press the I key. The Console Extender Detail menu opens.
4. Press the E key to edit the name of the extender.

CHAPTER 5: NETWORK SETTINGS

5.5 VIEW THE STATUS OF ALL LOCAL UNITS

The PC Extender List allows you to view all local units in the switching network and their current status.

To view the status of all local units:

1. Make sure the Master View menu is open (see Section 5.1, Access the Network Settings Menu [Master View and Network Mode]).

```
MASTER VIEW
O = Connections Overview
U = User List
C = Console Extender List
P = PC Extender List
M = Multi-Head Configuration

R = Restart All Extenders

Q = Exit
```

FIGURE 5-11. MASTER VIEW MENU

2. Press the P key. The PC Extender List menu opens.

```
MASTER VIEW PC > extender list
```

NAME	GROUP	STATUS
> <Untitled>	1	conn'd

```
R = Remove (Disconnected Only)
I = Info                      Q = Exit
```

FIGURE 5-12. PC EXTENDER LIST

3. To edit the name, groups or status of an extender, press the I key. The PC Extender Detail menu opens.
4. Use the Up and Down Arrow keys to select the name or group of the PC unit.
5. Press the E key to edit the selected parameter.

CHAPTER 5: NETWORK SETTINGS

Example:

There are the following 3 PCs: Department PC, Team A PC and Team B PC. The users Alex, Blair and Charlie should have access to the Department PC and the Team A PC. The users Danny, Em and Frankie should have access to the Department PC and the Team B PC.

To achieve this, we assign each PC a different group:

- ◆ Department PC: Group 1
- ◆ Team A PC: Group 2
- ◆ Team B PC: Group 3

Alex, Blair and Charlie are assigned to be members of Group 1 and Group 2. Danny, Em and Frankie are assigned to be members of Group 1 and Group 3.

5.6 SET UP DUAL-HEAD OR MULTI-HEAD SYSTEMS

If you use multiple monitors with a PC, then you can group individual local and remote units together in the Multi-Head menu, making them switch as a single unit.

To group individual local and remote extenders:

1. Make sure the Master View menu is open (see Section 5.1, Access the Network Settings Menu [Master View and Network Mode]).

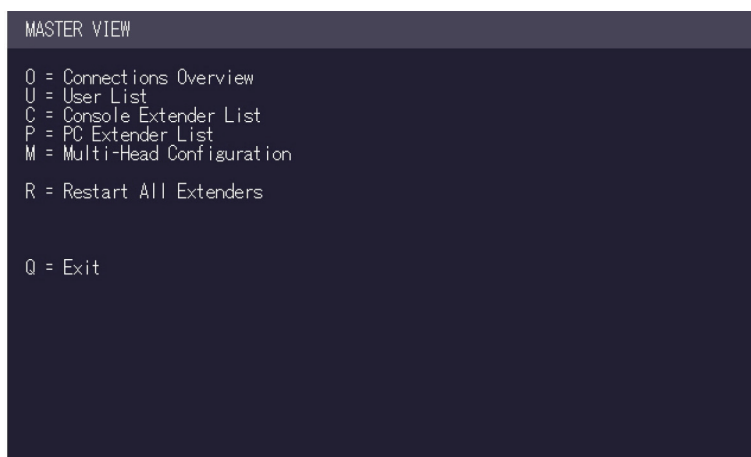

FIGURE 5-13. MASTER VIEW MENU

2. Press the M key. The Multi-Head configuration menu opens.

CHAPTER 5: NETWORK SETTINGS

```
MASTER VIEW > multi-head configuration

MULTI-HEAD SET   TYPE   SIZE

A = Add          R = Remove
I = Info         Q = Exit
```

FIGURE 5-14. MULTI-HEAD CONFIGURATION MENU

3. Press the A key. The multi-head detail menu opens.

- ◆ Press the R key to remove an extender from the multi-head set.
- ◆ Press the Q key to exit.

```
MASTER VIEW > multihead detail

> Name:  mhs1
Type:   Undefined
Heads:  0
Module List

A = Add Module   E = Edit
Q = Exit without Save
```

FIGURE 5-15. MULTI-HEAD DETAIL MENU

4. Press the A key to add individual extenders. The extender type is automatically determined once the first extender has been selected.

5. Press the E key to edit the multi-head set name of max. 16 characters.

CHAPTER 5: NETWORK SETTINGS

5.7 ENABLE USER GROUPS AND RIGHTS AND LOGIN ACCESS

The Passwords option allows to activate user groups and rights and login access. For more information about user groups and rights see Section 5.3, Manage User Details, Rights and Groups.

Access to the network settings is always protected by a login and password, even when the password system is disabled.

To enable the password option:

1. Make sure the Network Mode menu is open (see Section 5.1, Access the Network Settings Menu [Master View and Network Mode]).
2. Press the P key to disable or enable the option.

```
NETWORK SETTINGS > modes
P = Passwords ..... [Enabled]
C = Auto Connect ..... [Disabled]
V = Private Connections .... [Disabled]
B = User-PC Binding ..... [Disabled]
D = Discon on PC Power Down . [Disabled]
H = Hide Info Display ..... [Disabled]
T = Reconnect on Startup .... [Disabled]
S = Video Sharing ..... [Disabled]
A = Ask User Before Discon .. [Disabled]
Q = Exit
```

FIGURE 5-16. NETWORK SETTINGS → MODE SCREEN

CHAPTER 5: NETWORK SETTINGS

5.8 AUTO-CONNECT TO A FREE COMPUTER AFTER AN INTERRUPTION

The Auto Connect option allows you to connect automatically with a free computer if your connection is interrupted by another user. This function is unavailable while using the Password System.

To enable the auto-connect option:

1. Make sure the Network Mode menu is open (see Access the Switching menu, Master View and Network Mode).
2. Press the C key to disable or enable the option.

```
NETWORK SETTINGS > modes
P = Passwords ..... [Disabled]
C = Auto Connect ..... [Enabled]
V = Private Connections ..... [Disabled]
B = User-PC Binding ..... [Disabled]
D = Discon on PC Power Down . [Disabled]
H = Hide Info Display ..... [Disabled]
T = Reconnect on Startup .... [Enabled]
S = Video Sharing ..... [Disabled]
A = Ask User Before Discon .. [Disabled]
Q = Exit
```

FIGURE 5-17. ENABLE AUTO-CONNECT SCREEN

CHAPTER 5: NETWORK SETTINGS

5.9 SET UP A PRIVATE CONNECTION

The Auto Connect option allows you to set up a private connection with a computer, which can't be interrupted by other users.

To enable the private connection option:

1. Make sure the Network Mode menu is open (see Access the Switching menu, Master View and Network Mode).
2. Press the V key to disable or enable the option.
3. To establish a private connection hold down Shift while you select a new connection (either in the switching menu or by pressing the hot-key combination (see Section 4.10, Switch Between Different Computers).

```
NETWORK SETTINGS > modes
P = Passwords ..... [Disabled]
C = Auto Connect ..... [Disabled]
V = Private Connections ..... [Enabled]
B = User-PC Binding ..... [Disabled]
D = Discon on PC Power Down . [Disabled]
H = Hide Info Display ..... [Disabled]
T = Reconnect on Startup .... [Disabled]
S = Video Sharing ..... [Disabled]
A = Ask User Before Discon .. [Disabled]

Q = Exit
```

FIGURE 5-18. PRIVATE CONNECTION OPTION

5.10 ENABLE THE USER-PC BINDING MODE

To enable the User-PC Binding mode:

1. Make sure the Network Mode menu is open (see Access the Switching menu, Master View and Network Mode).
2. Press the B key to disable or enable the option.

```
NETWORK SETTINGS > modes
P = Passwords ..... [Enabled]
C = Auto Connect ..... [Disabled]
V = Private Connections ..... [Disabled]
B = User-PC Binding ..... [Enabled]
D = Discon on PC Power Down . [Disabled]
H = Hide Info Display ..... [Disabled]
T = Reconnect on Startup .... [Disabled]
S = Video Sharing ..... [Disabled]
A = Ask User Before Discon .. [Disabled]

Q = Exit
```

FIGURE 5-19. USER-PC BINDING MODE OPTION

CHAPTER 5: NETWORK SETTINGS

5.11 ENABLE THE DISCONNECT ON PC POWER DOWN OPTION

The Auto Connect option allows you to break the connection of any local unit that is connected to a PC that is powered down, allowing the remote unit to find a different local extender to connect to.

To enable the PC Power Down option:

1. Make sure the Network Mode menu is open (see Access the Switching menu, Master View and Network Mode).
2. Press the D key to disable or enable the option.

```
NETWORK SETTINGS > modes
P = Passwords ..... [Disabled]
C = Auto Connect ..... [Enabled]
V = Private Connections ..... [Disabled]
B = User-PC Binding ..... [Disabled]
D = Discon on PC Power Down . [Enabled]
H = Hide Info Display ..... [Disabled]
T = Reconnect on Startup .... [Enabled]
S = Video Sharing ..... [Disabled]
A = Ask User Before Discon .. [Disabled]

Q = Exit
```

FIGURE 5-20. DISCONNECT ON PC POWER DOWN OPTION

5.12 HIDE INFO DISPLAY

To hide the info display during startup:

1. Make sure the Network Mode menu is open (see Access the Switching menu, Master View and Network Mode).
2. Press the H key to disable or enable the option.

```
NETWORK SETTINGS > modes
P = Passwords ..... [Disabled]
C = Auto Connect ..... [Disabled]
V = Private Connections ..... [Disabled]
B = User-PC Binding ..... [Disabled]
D = Discon on PC Power Down . [Disabled]
H = Hide Info Display ..... [Enabled]
T = Reconnect on Startup .... [Disabled]
S = Video Sharing ..... [Disabled]
A = Ask User Before Discon .. [Disabled]

Q = Exit
```

FIGURE 5-21. HIDE INFO DISPLAY OPTION

CHAPTER 5: NETWORK SETTINGS

5.13 RECONNECT ON STARTUP

To reconnect on startup:

1. Make sure the Network Mode menu is open (see Access the Switching menu, Master View and Network Mode).
2. Press the T key to disable or enable the option.

```
NETWORK SETTINGS > modes
P = Passwords ..... [Disabled]
C = Auto Connect ..... [Disabled]
V = Private Connections ..... [Disabled]
B = User-PC Binding ..... [Disabled]
D = Discon on PC Power Down . [Disabled]
H = Hide Info Display ..... [Disabled]
T = Reconnect on Startup .... [Enabled]
S = Video Sharing ..... [Disabled]
A = Ask User Before Discon .. [Disabled]

Q = Exit
```

FIGURE 5-22. RECONNECT ON STARTUP OPTION

5.14 VIDEO SHARING

See Section 4.11, Share Videos.

5.15 SET THE PASSWORD TIMEOUT

When the password system is activated, you can define under what circumstances the user will be required to re-enter their login details when switching.

- ♦ I – Immediately: User and password must be re-entered for each switch.
- ♦ N – Never: User and password are not required to be re-entered until the current user logs out. See Section 4.10, Switch Between Different Computers.
- ♦ T – Time in min: You define the number of minutes since the last switch before the user and password details are required again to switch.

```
NETWORK SETTINGS > timeout  
  
See product manual  
for explanation.  
  
> I - Immediately  
   N - Never  
   T - Time in mins  
  
Press ESC to exit
```

FIGURE 5-23. SET PASSWORD TIMEOUT OPTION

CHAPTER 6: MAINTENANCE AND CARE

CAUTION! Do not use solvent-containing cleansers. Do not use wipes, alcohols (e.g. spiritus) or chemicals as these could damage the surface.

To clean the product:

- ◆ Clean the product with a maintenance product for synthetic material, which is available in specialized shops.



CHAPTER 7: TROUBLESHOOTING

TABLE 7-1. TROUBLESHOOTING

ERROR	CAUSE	SOLUTION
LED is not lighting	The devices get no power	Make sure the power supply is connected
LED is lighting red	No connection between local and remote	Check if the RJ-45/network cable is connected securely to both remote and local units. If this still does not work, contact Black Box Technical Support at 877-877-2269 or info@blackbox.com
LED is lighting orange	No picture on the monitor	Check if the local (PC) cable is connected securely. Check if the remote (monitor) cable is connected securely. If everything is connected securely but no function appears, reconnect the power supply again. If the menu is visible, press the O key and choose the resolution of the monitor. Then press the assigned number on your keyboard.
LED is lighting green	Screen has picture but the keyboard is not working	Plug out/in USB of keyboard and wait until driver is installed (after a few seconds). Check all USB connections on both sides (Local and Remote) If it is still not working, plug out/in DC once more.
LED is lighting green	No audio	Establish audio connection: plug the stereo jack to the audio output of the PC (green) connection with local: IN; remote: headset OUT Establish microphone connection: plug the stereojack to the microphone input of the PC (pink) connection with local OUT
LED is lighting green	The screen flickers, has an incorrect display	Install current firmware. Contact Black Box Technical Support at 877-877-2269 or info@blackbox.com
LED is blinking green	Different firmware or USB is not compatible	Contact Black Box Technical Support at 877-877-2269 or info@blackbox.com
LED is lighting differently	Different firmware	To enter on screen menu/check firmware version: To enter the On screen menu, press the Scroll Lock key five times in quick succession. The currently installed firmware version is displayed below the menu. If firmware update does not work, contact Black Box Technical Support at 877-877-2269 or info@blackbox.com

CHAPTER 8: DISPOSAL



This symbol on the product, the accessories or packaging indicates that this product must not be treated as unsorted municipal waste, but must be collected separately! Dispose of the product via a collection point for the recycling of waste electrical and electronic equipment within the EU and in other European countries that operate separate collection systems for waste electrical and electronic equipment.

By disposing of the product in the proper manner, you help to avoid possible hazards for the environment and public health that could otherwise be caused by improper treatment of waste equipment. The recycling of materials contributes to the conservation of natural resources. Therefore do not dispose of your old electrical and electronic equipment with the unsorted municipal waste.

The packaging is made of environmentally friendly materials, which may be disposed through your local recycling facilities. By disposing of the packaging and packaging waste in the proper manner, you help to avoid possible hazards for the environment and public health.

CHAPTER 9: TECHNICAL SUPPORT

9.1 CONTACTING BLACK BOX TECHNICAL SUPPORT

If you determine that your Extender is malfunctioning, do not attempt to alter or repair the unit. It contains no user-serviceable parts. Contact Black Box Technical Support at 877-877-2269 or info@blackbox.com.

Before you do, make a record of the history of the problem. We will be able to provide more efficient and accurate assistance if you have a complete description, including:

- ♦ the nature and duration of the problem.
- ♦ when the problem occurs.
- ♦ the components involved in the problem.
- ♦ any particular application that, when used, appears to create the problem or make it worse.

9.2 SHIPPING AND PACKAGING

If you need to transport or ship your Extender:

- ♦ Package it carefully. We recommend that you use the original container.
- ♦ If you are returning the unit, make sure you include everything you received with it. Before you ship for return or repair, contact Black Box to get a Return Authorization (RA) number.

APPENDIX A: REQUIREMENTS FOR CAT5/6/7 CABLES

A CAT5/6/7 cable should meet the following requirements:

- ◆ The pins are connected 1:1.

CAUTION: The cable pairs must be twisted to EIA/TIA- 568A (rare) or EIA/TIA-568 B (common) pairs.

- ◆ Erroneous assignments cannot be found with a simple cable tester.
- ◆ The pins for the green pair of wires are not adjacent to one other.
- ◆ The cable must at the very least meet the CAT5 specifications and be suitable for Gigabit transmission.
- ◆ The cable should meet one of the following standards: Class D ISO/IEC 11801:2002 or EN 50173-1:2002. Schema EIA/TIA-568 B.
- ◆ Only use shielded installation cable with min. cross section of 24 AWG throughout the length.
- ◆ The shield should be contiguous and connected to both ends. A shielded patch cable is allowed for connection to the device.

PIN	COLOR
1	Orange/White
1	Orange
1	Green/White
1	Blue
1	Blue/White
1	Green
1	Brown/White
1	Brown

FIGURE A-1. CAT5/6/7 PINNING CHART

APPENDIX B: REQUIREMENTS FOR A NETWORK SWITCH

The entire switching network system requires its own dedicated network. For security reasons it cannot be integrated into an existing company network.

The network switch must fulfil the following specifications:

- ◆ 1 Gigabit Switch, with true port to port transfer rates of 1 Gigabit/second

APPENDIX C: REGULATORY INFORMATION

C.1 FCC STATEMENT

This equipment generates, uses, and can radiate radio-frequency energy, and if not installed and used properly, that is, in strict accordance with the manufacturer's instructions, may cause interference to radio communication. It has been tested and found to comply with the limits for a Class A computing device in accordance with the specifications in Subpart B of Part 15 of FCC rules, which are designed to provide reasonable protection against such interference when the equipment is operated in a commercial environment. Operation of this equipment in a residential area is likely to cause interference, in which case the user at his own expense will be required to take whatever measures may be necessary to correct the interference.

Changes or modifications not expressly approved by the party responsible for compliance could void the user's authority to operate the equipment.

This digital apparatus does not exceed the Class A limits for radio noise emission from digital apparatus set out in the Radio Interference Regulation of Industry Canada.

Le présent appareil numérique n'émet pas de bruits radioélectriques dépassant les limites applicables aux appareils numériques de la classe A prescrites dans le Règlement sur le brouillage radioélectrique publié par Industrie Canada.



APPENDIX C: REGULATORY INFORMATION

C.2 NOM STATEMENT

1. Todas las instrucciones de seguridad y operación deberán ser leídas antes de que el aparato eléctrico sea operado.
2. Las instrucciones de seguridad y operación deberán ser guardadas para referencia futura.
3. Todas las advertencias en el aparato eléctrico y en sus instrucciones de operación deben ser respetadas.
4. Todas las instrucciones de operación y uso deben ser seguidas.
5. El aparato eléctrico no deberá ser usado cerca del agua—por ejemplo, cerca de la tina de baño, lavabo, sótano mojado o cerca de una alberca, etc.
6. El aparato eléctrico debe ser usado únicamente con carritos o pedestales que sean recomendados por el fabricante.
7. El aparato eléctrico debe ser montado a la pared o al techo sólo como sea recomendado por el fabricante.
8. Servicio—El usuario no debe intentar dar servicio al equipo eléctrico más allá a lo descrito en las instrucciones de operación. Todo otro servicio deberá ser referido a personal de servicio calificado.
9. El aparato eléctrico debe ser situado de tal manera que su posición no interfiera su uso. La colocación del aparato eléctrico sobre una cama, sofá, alfombra o superficie similar puede bloquea la ventilación, no se debe colocar en libreros o gabinetes que impidan el flujo de aire por los orificios de ventilación.
10. El equipo eléctrico deber ser situado fuera del alcance de fuentes de calor como radiadores, registros de calor, estufas u otros aparatos (incluyendo amplificadores) que producen calor.
11. El aparato eléctrico deberá ser conectado a una fuente de poder sólo del tipo descrito en el instructivo de operación, o como se indique en el aparato.
12. Precaución debe ser tomada de tal manera que la tierra física y la polarización del equipo no sea eliminada.
13. Los cables de la fuente de poder deben ser guiados de tal manera que no sean pisados ni pellizcados por objetos colocados sobre o contra ellos, poniendo particular atención a los contactos y receptáculos donde salen del aparato.
14. El equipo eléctrico debe ser limpiado únicamente de acuerdo a las recomendaciones del fabricante.
15. En caso de existir, una antena externa deberá ser localizada lejos de las líneas de energía.
16. El cable de corriente deberá ser desconectado del cuando el equipo no sea usado por un largo periodo de tiempo.
17. Cuidado debe ser tomado de tal manera que objetos líquidos no sean derramados sobre la cubierta u orificios de ventilación.
18. Servicio por personal calificado deberá ser provisto cuando:
 - A: El cable de poder o el contacto ha sido dañado; u
 - B: Objetos han caído o líquido ha sido derramado dentro del aparato; o
 - C: El aparato ha sido expuesto a la lluvia; o
 - D: El aparato parece no operar normalmente o muestra un cambio en su desempeño; o
 - E: El aparato ha sido tirado o su cubierta ha sido dañada.

APPENDIX D: DISCLAIMER/TRADEMARKS

D.1 DISCLAIMER

Black Box Corporation shall not be liable for damages of any kind, including, but not limited to, punitive, consequential or cost of cover damages, resulting from any errors in the product information or specifications set forth in this document and Black Box Corporation may revise this document at any time without notice.

D.2 TRADEMARKS USED IN THIS MANUAL

Black Box and the Black Box logo type and mark are registered trademarks of Black Box Corporation.

Any other trademarks mentioned in this manual are acknowledged to be the property of the trademark owners.



NOTES

NEED HELP?
LEAVE THE TECH TO US

**LIVE 24/7
TECHNICAL
SUPPORT**

1.877.877.2269

Lined area for notes, consisting of multiple horizontal dashed lines.



**NEED HELP?
LEAVE THE TECH TO US**

**LIVE 24/7
TECHNICAL
SUPPORT**

1.877.877.2269

